



US00D382571S

United States Patent [19] Bruns

[11] Patent Number: Des. 382,571
[45] Date of Patent: **Aug. 19, 1997

[54] FINGER PRESS WHEEL

5,517,932 5/1996 Ott et al. 111/193

[76] Inventor: Mark W. Bruns, P.O. Box 33, Gibbon,
Minn. 55335

FOREIGN PATENT DOCUMENTS

[**] Term: 14 Years

594274	3/1960	Canada	111/194
1141-237	2/1983	Canada	111/137
2810-221	7/1979	Germany	111/194
127968	12/1928	Switzerland	111/195
2122062	1/1984	United Kingdom	172/604

[21] Appl. No.: 45,706

[22] Filed: Oct. 27, 1995

OTHER PUBLICATIONS

[51] LOC (6) Cl. 15-03

Progressive Farmer, Dec. 1993 p. P/G 8 Acra-Plant Spoke Press Wheel.

[52] U.S. Cl. D15/29

[58] Field of Search D15/10, 11, 28,
D15/29; 111/191, 192, 193, 163; 172/540,
557

Primary Examiner—Sandra L. Morris

Attorney, Agent, or Firm—Burd, Bartz & Gutenkauf

[56] References Cited

[57] CLAIM

U.S. PATENT DOCUMENTS

The ornamental design for a finger press wheel, as shown and described.

22,676	1/1859	Seaman	111/195
D. 138,712	9/1944	Karl	D15/29
375,741	1/1888	Gilmore et al.	
489,037	1/1893	Roadhouse	
1,688,914	10/1928	Ariens	D15/11
1,847,327	3/1932	Bateman	
2,924,189	2/1960	McLeod	111/80
3,742,877	7/1973	Coffee	111/6
4,009,668	3/1977	Brass et al.	111/85
4,055,126	10/1977	Brown et al.	111/85
4,070,974	1/1978	Stacy, Jr.	111/85
4,278,036	7/1981	Buchele	111/52
4,295,532	10/1981	Williams et al.	172/184
4,377,979	3/1983	Peterson et al.	111/52
4,391,335	7/1983	Birkenbach	172/540
4,425,973	1/1984	Williams et al.	172/574
4,585,073	4/1986	Mayeda et al.	172/158
4,785,890	11/1988	Martin	172/29
5,129,282	7/1992	Bassett et al.	74/529
5,341,754	8/1994	Winterton	111/139
5,346,020	9/1994	Bassett	172/540
5,398,625	3/1995	Johnson et al.	111/189
5,437,336	8/1995	Symonds	172/176
5,443,023	8/1995	Carroll	111/191
5,461,995	10/1995	Winterton	111/137
5,477,792	12/1995	Bassett et al.	111/191
5,497,717	3/1996	Martin	111/191

DESCRIPTION

FIG. 1 is a front elevational view of the finger press wheel of my new design;
 FIG. 2 is a bottom plan view thereof, the top plan view is a mirror image thereof;
 FIG. 3 is a rear elevational view thereof;
 FIG. 4 is a side elevational view of the right side thereof, the side elevational view of the left side is a mirror image thereof;
 FIG. 5 is a sectional view taken along the line 5—5 of FIG. 1;
 FIG. 6 is a front elevational view of a second embodiment of the design;
 FIG. 7 is a bottom plan view of FIG. 6, the top plan view is a mirror image thereof;
 FIG. 8 is a rear elevational view of FIG. 6;
 FIG. 9 is a side elevational view of the right side of FIG. 6, the side elevational view of the left side of FIG. 6 is a mirror image thereof; and,
 FIG. 10 is a sectional view taken along the line 10—10 of FIG. 6.

1 Claim, 2 Drawing Sheets

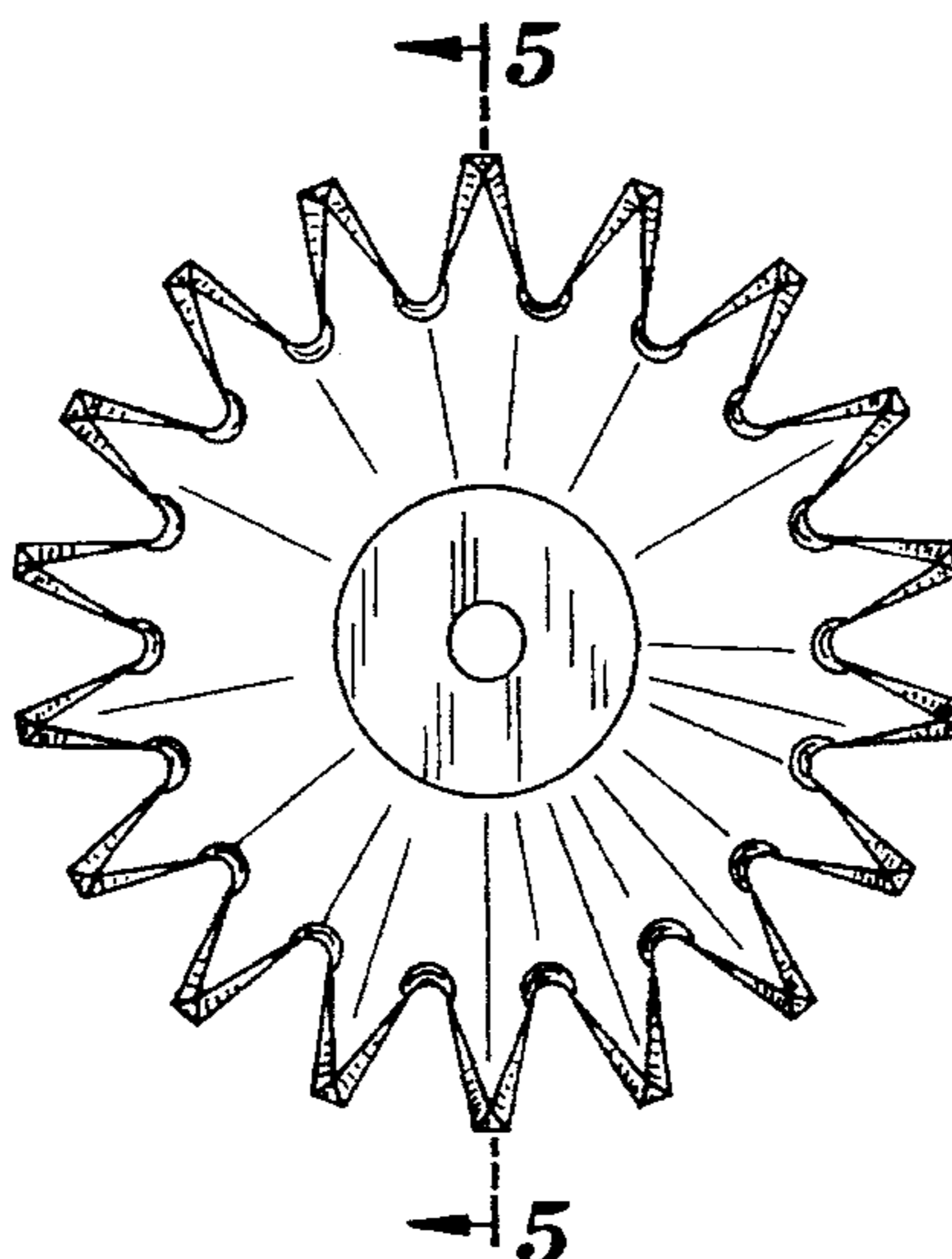

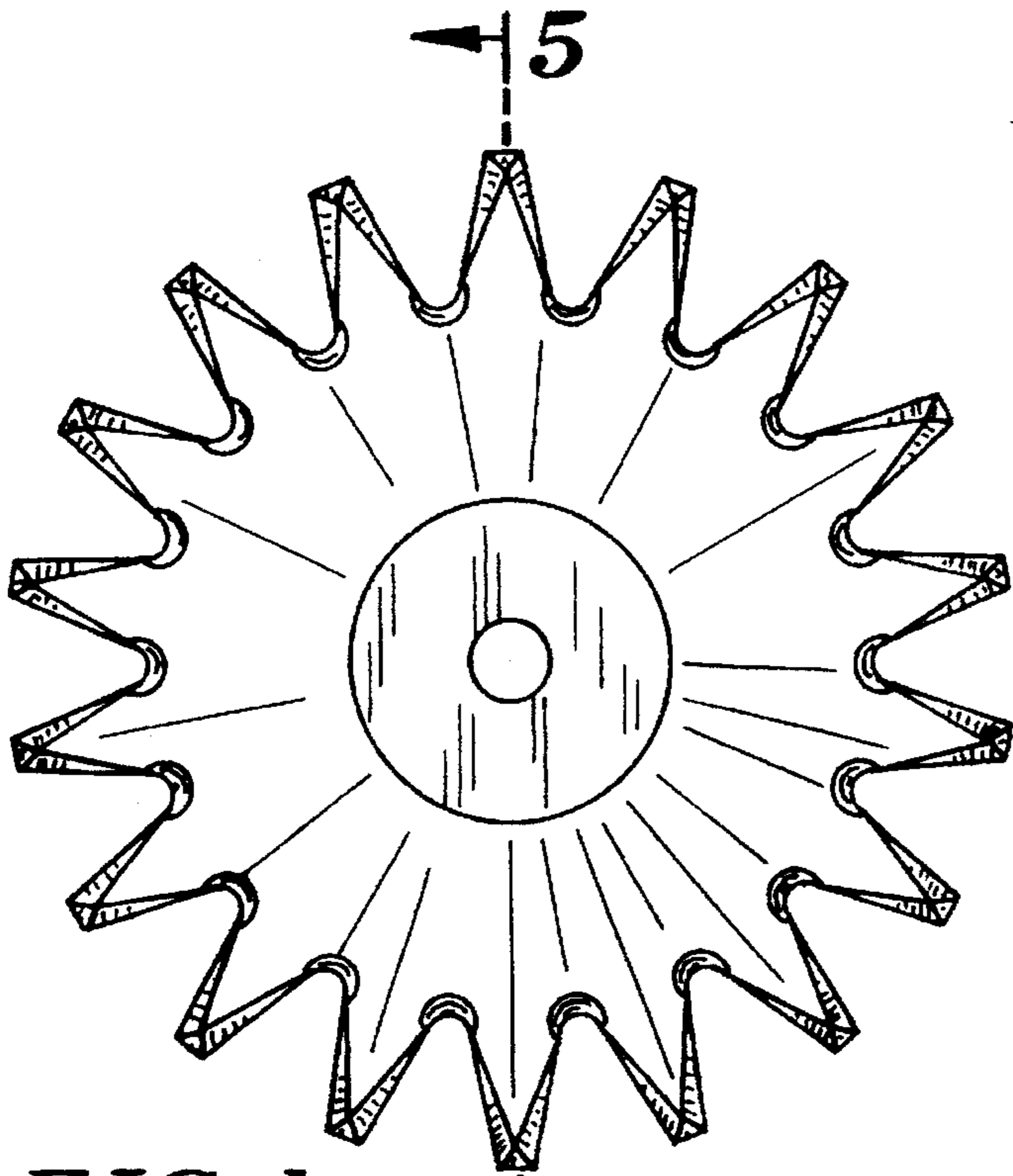

FIG. 1

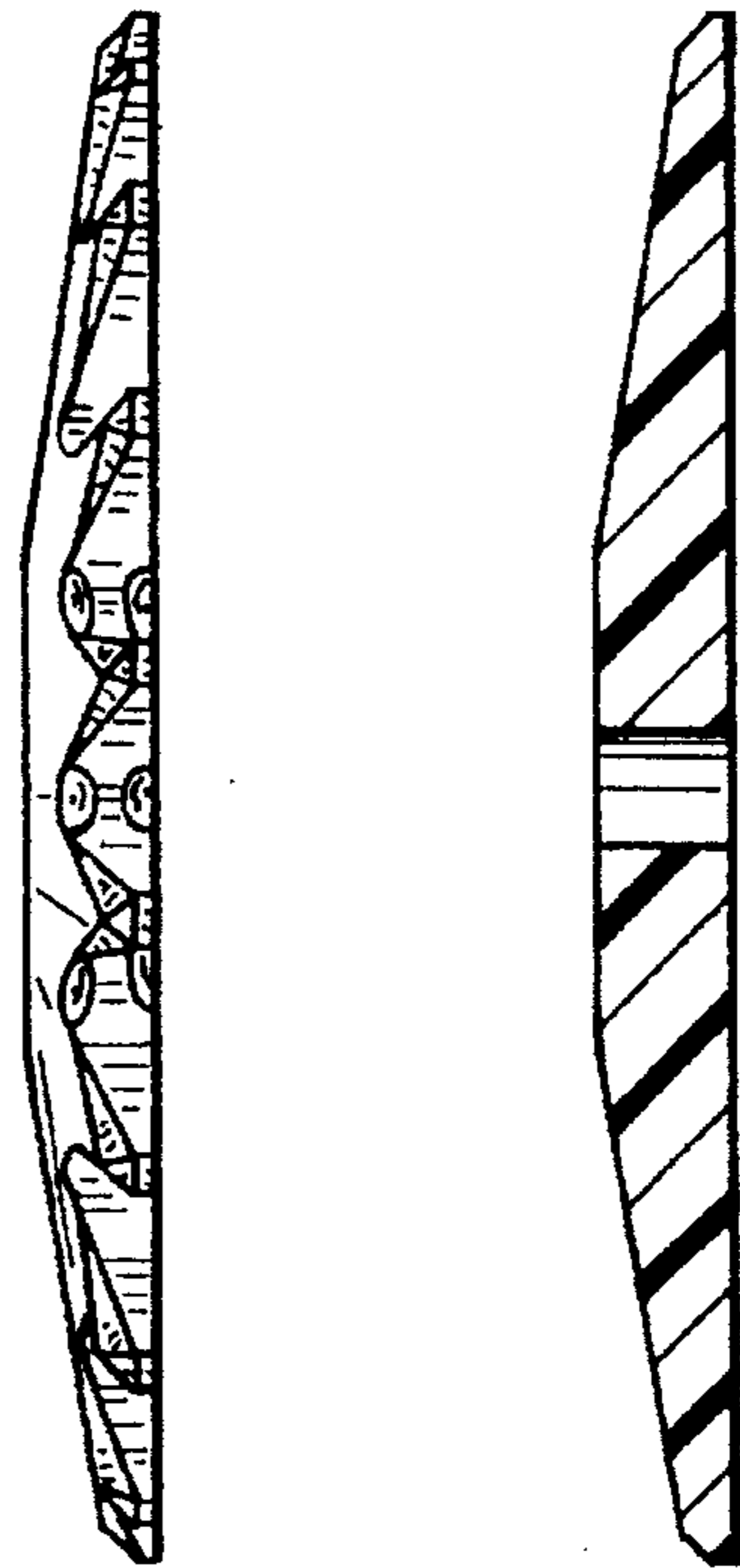

FIG. 4 FIG. 5



FIG. 2

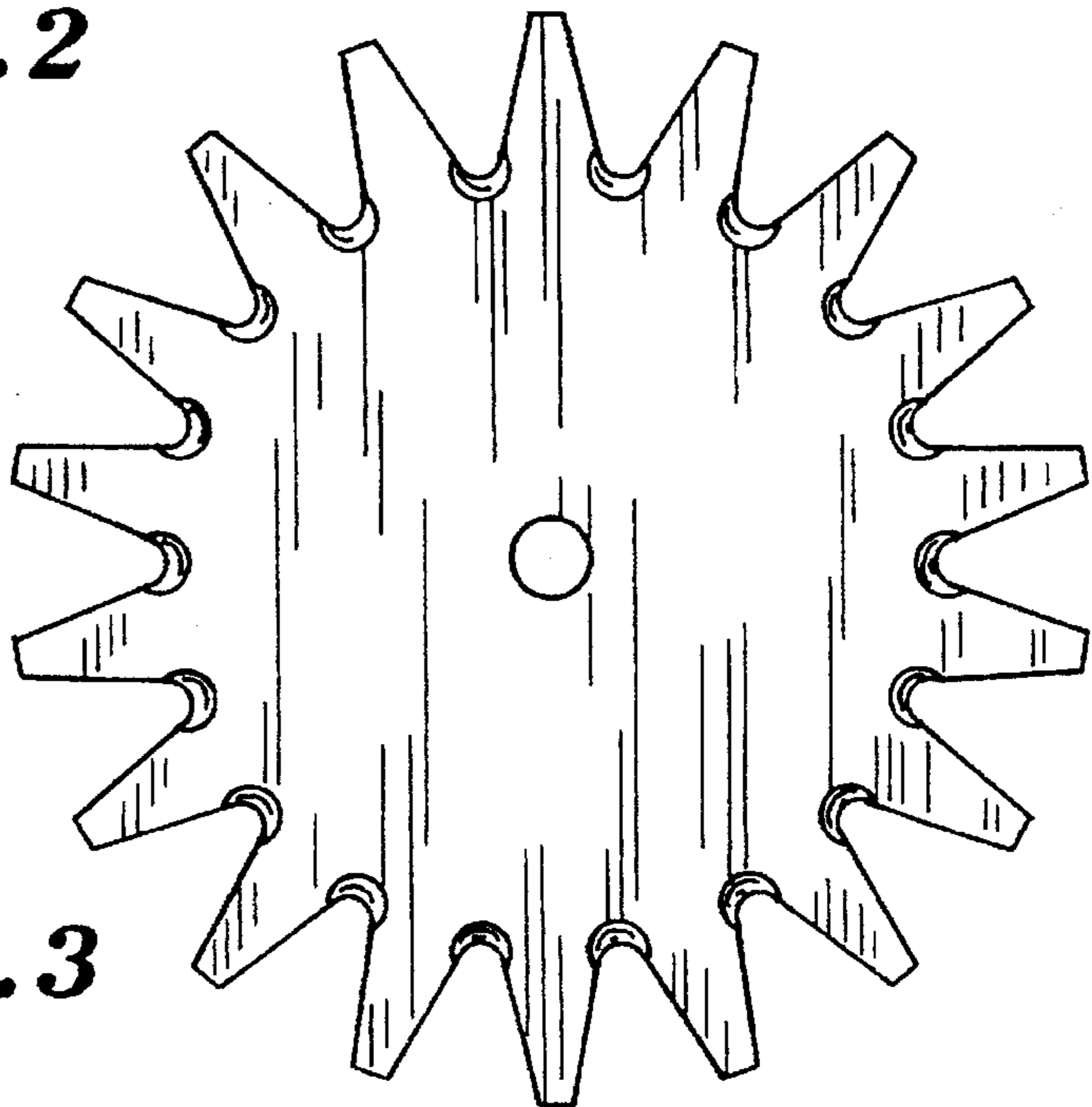

FIG. 3

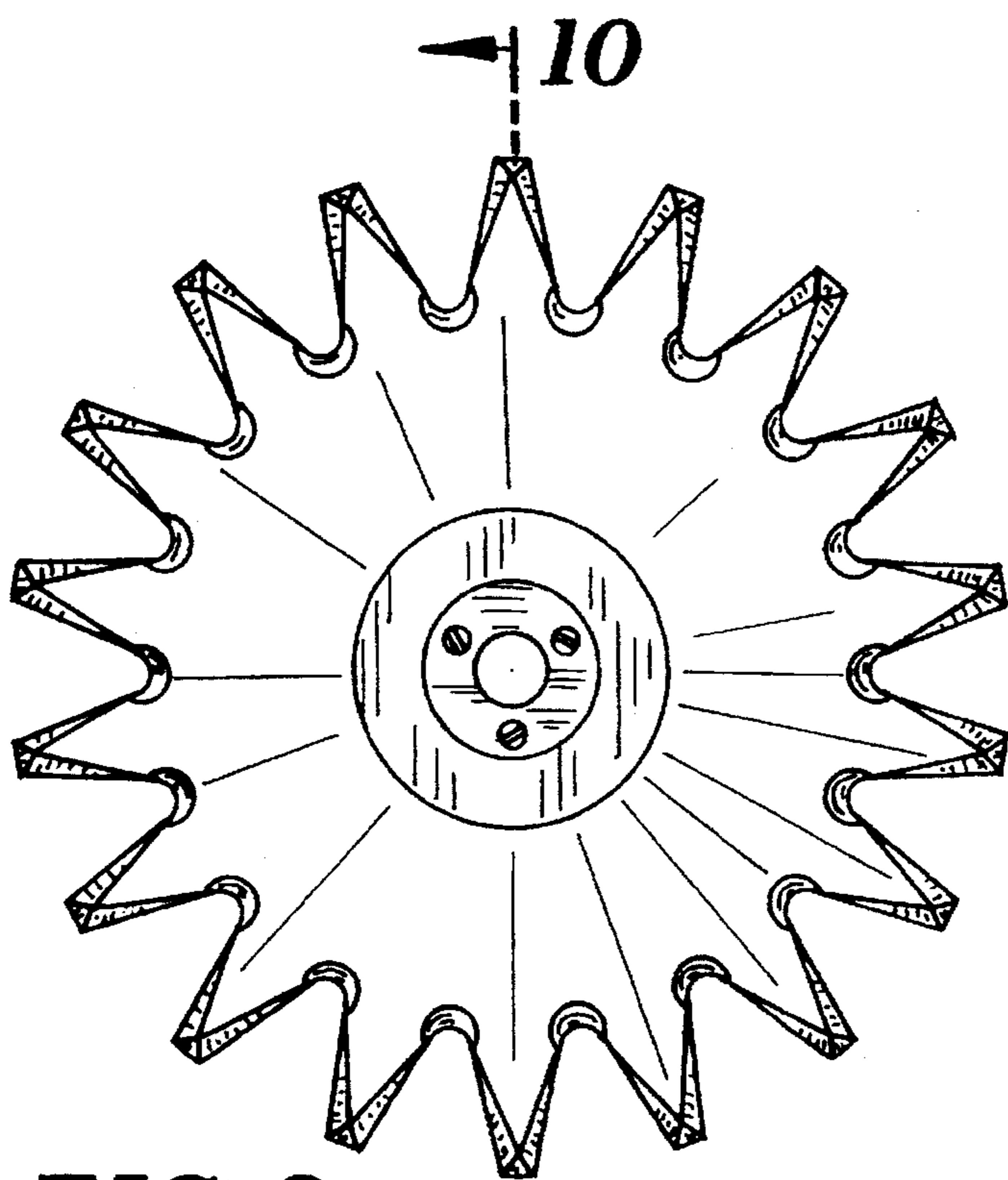

FIG. 6

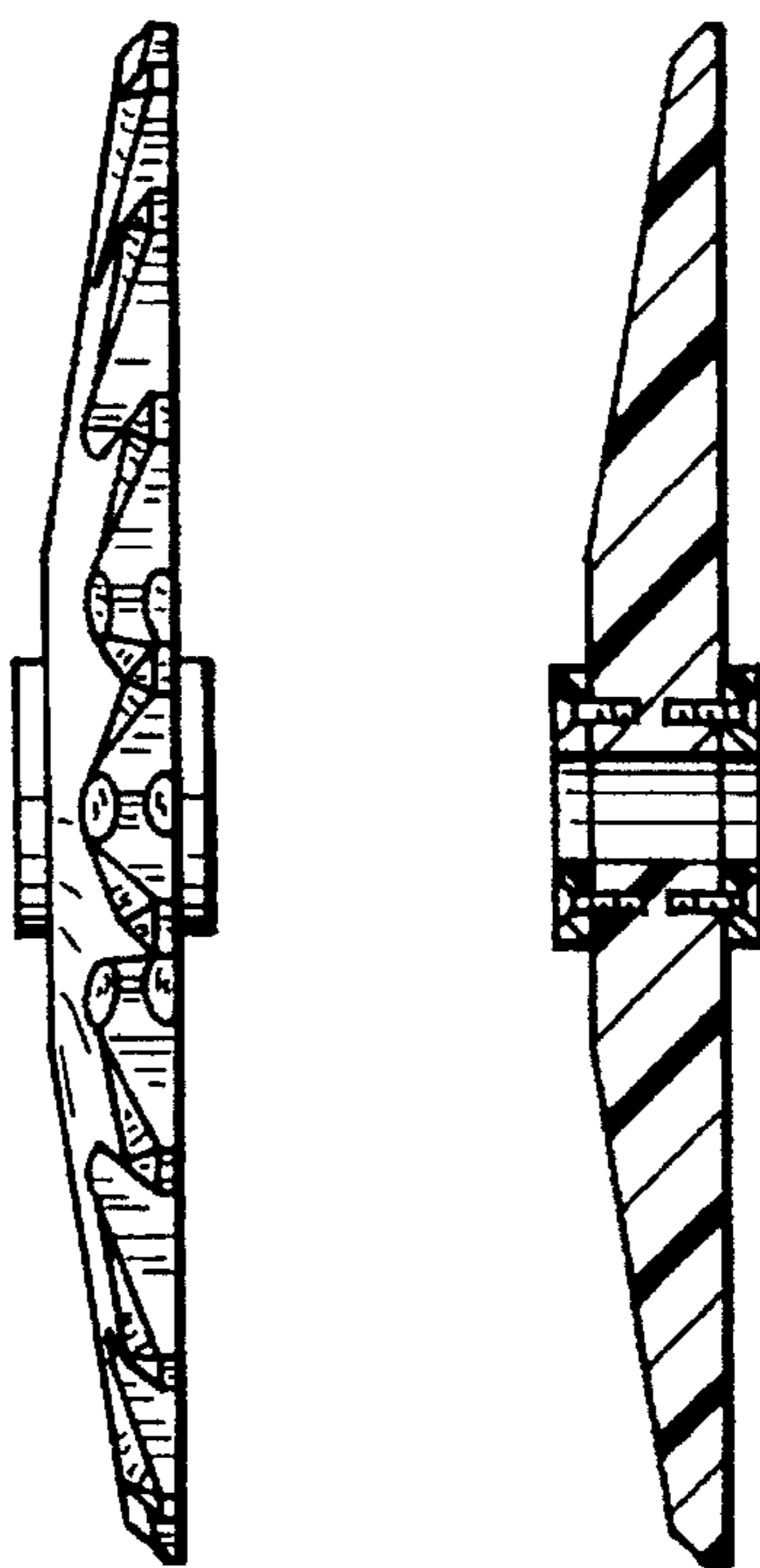

FIG. 9 FIG. 10



FIG. 7

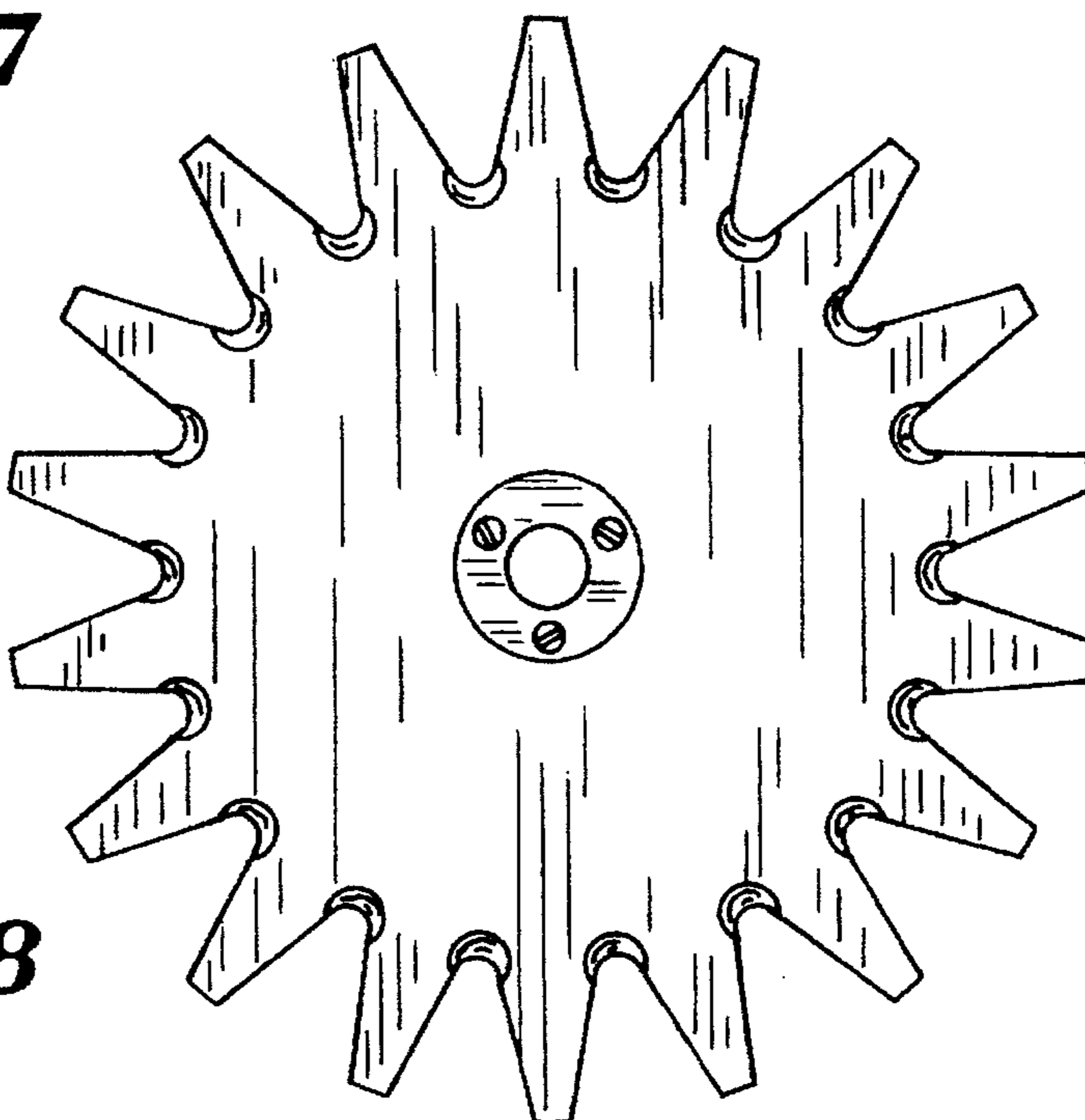

FIG. 8