



US00D382437S

# United States Patent [19]

Amiel

[11] Patent Number: Des. 382,437

[45] Date of Patent: \*\*Aug. 19, 1997

[54] COFFEE/ESPRESSO MACHINE

[75] Inventor: Richard Amiel, Oberaach, Switzerland

[73] Assignee: Eugster/Frismag AG, Romanshorn, Switzerland

[\*\*] Term: 14 Years

[21] Appl. No.: 45,363

[22] Filed: Oct. 18, 1995

D. 358,736 5/1995 Kahlcke ..... D7/310 X

D. 366,982 2/1996 Amiel ..... D7/311 X

D. 367,798 3/1996 Storsberg ..... D7/311 X

4,603,620 8/1986 Daugherty ..... D7/309 X

4,644,856 2/1987 Borgmann ..... D7/309 X

Primary Examiner—M. N. Pandozzi  
 Attorney, Agent, or Firm—Darby & Darby

### [57] CLAIM

The ornamental design for coffee/espresso machine, as shown and described.

[51] LOC (6) Cl. .... 07-01

[52] U.S. Cl. .... D7/309; D7/310; D7/311

[58] Field of Search ..... D7/309, 310, 311, D7/300, 312, 305; 99/306, 395, 286

### DESCRIPTION

FIG. 1 is a front perspective view of a coffee/espresso machine showing my new design;

FIG. 2 is a three-quarter perspective right side view thereof;

FIG. 3 is a three-quarter perspective left side view thereof;

FIG. 4 is a three-quarter perspective rear view thereof;

FIG. 5 is a front elevation view thereof;

FIG. 6 is a right side elevation view thereof;

FIG. 7 is a left side elevation view thereof; and,

FIG. 8 is a rear elevation view thereof.

### [56] References Cited

#### U.S. PATENT DOCUMENTS

D. 288,517 3/1987 Kahlcke ..... D7/309

D. 295,486 5/1988 Eugster et al. .... D7/312

D. 299,998 2/1989 Seiffert ..... D7/311 X

D. 314,881 2/1991 Wondergen et al. .... D7/309

D. 337,915 8/1993 Kahlcke ..... D7/312 X

D. 343,758 2/1994 Beeren ..... D7/309

1 Claim, 8 Drawing Sheets

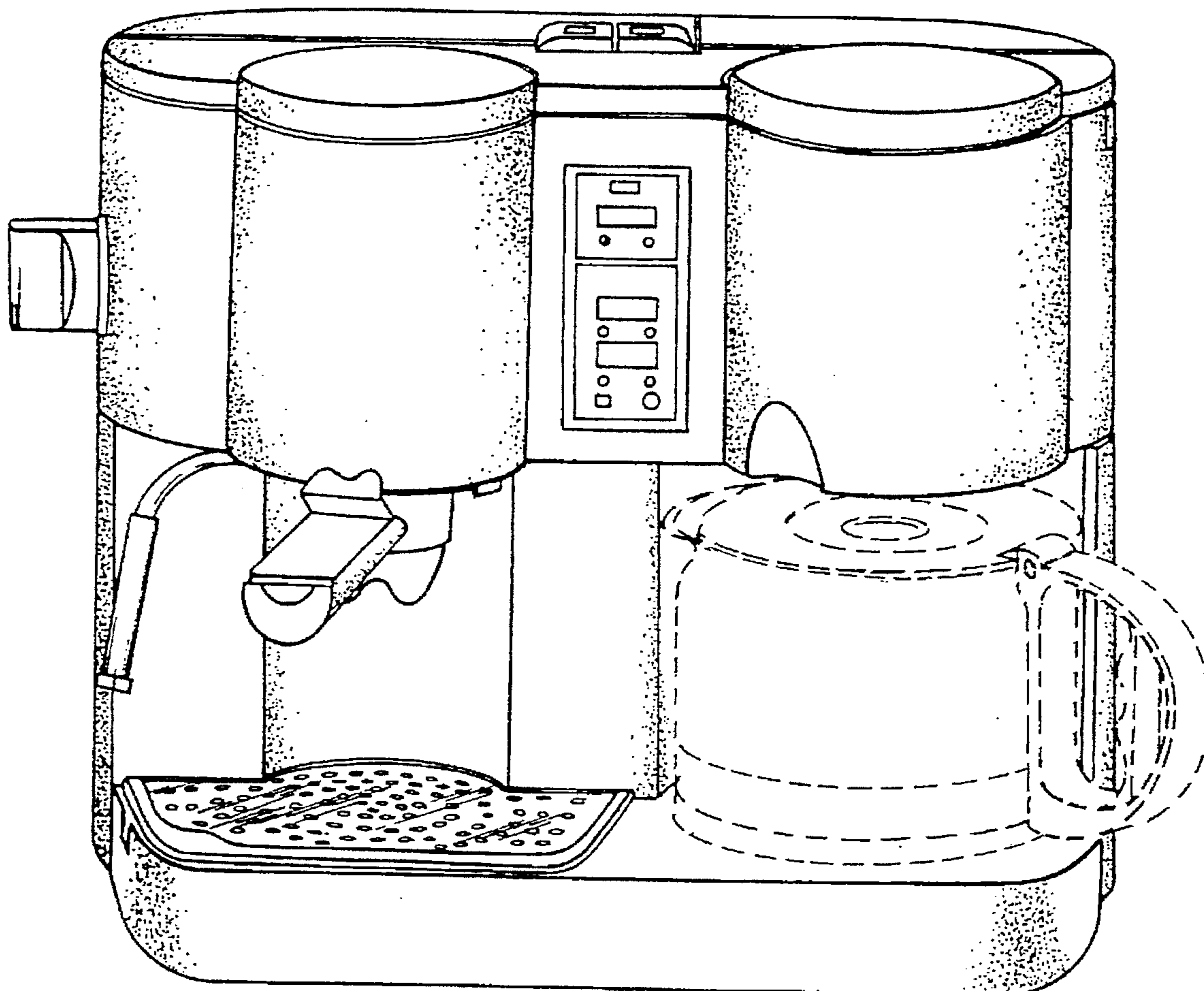

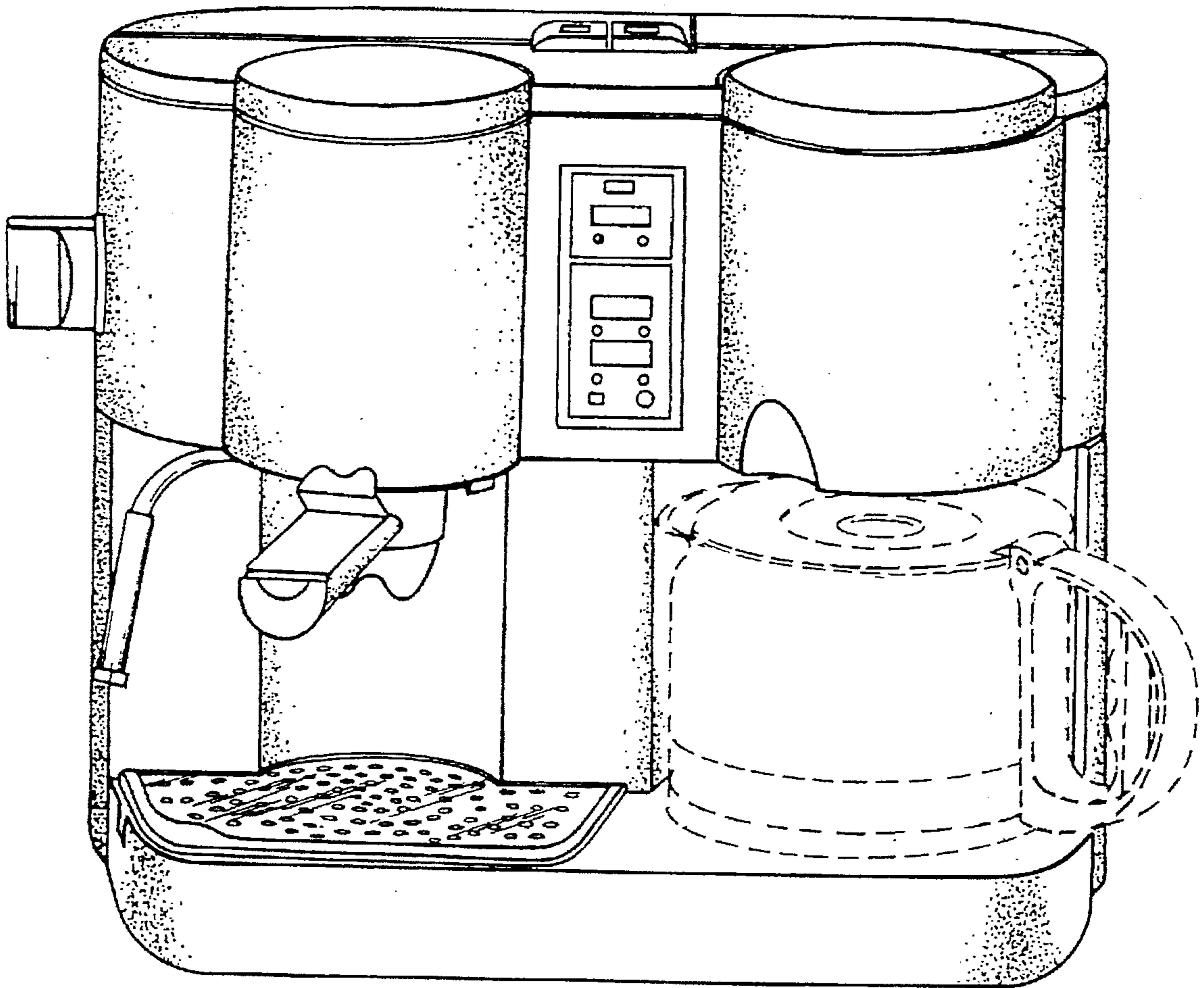

FIG. 1

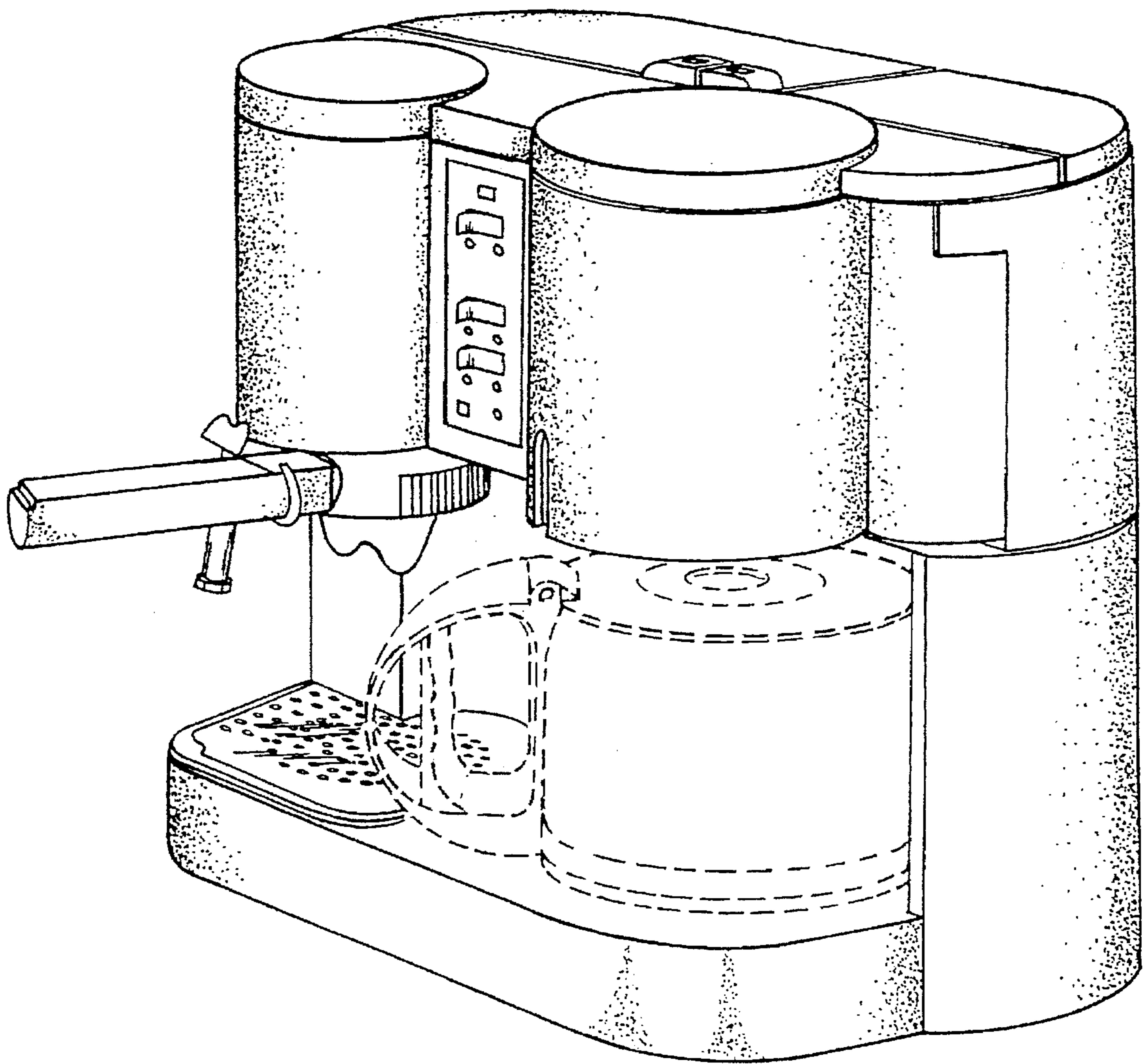

FIG. 2

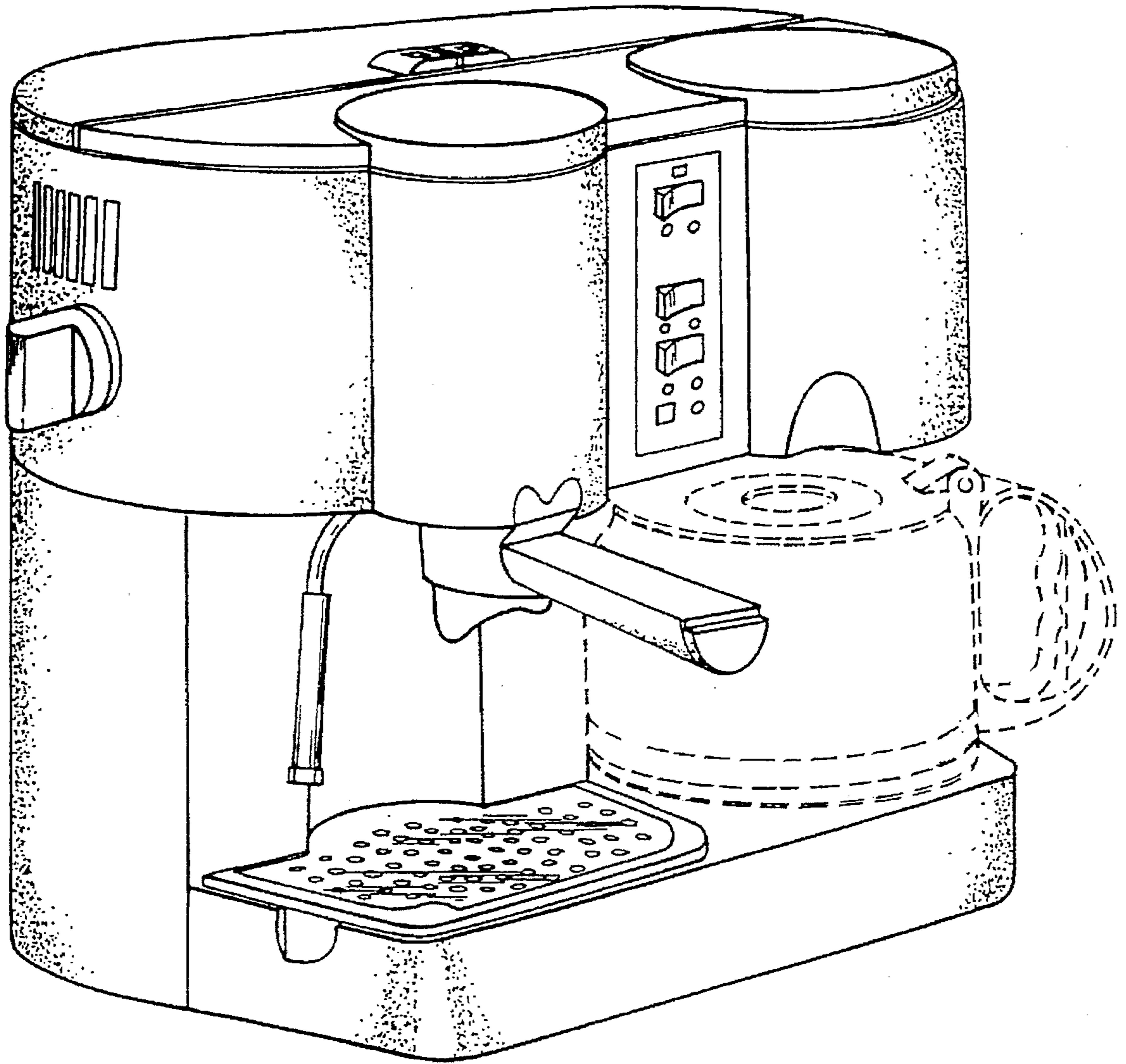

FIG. 3

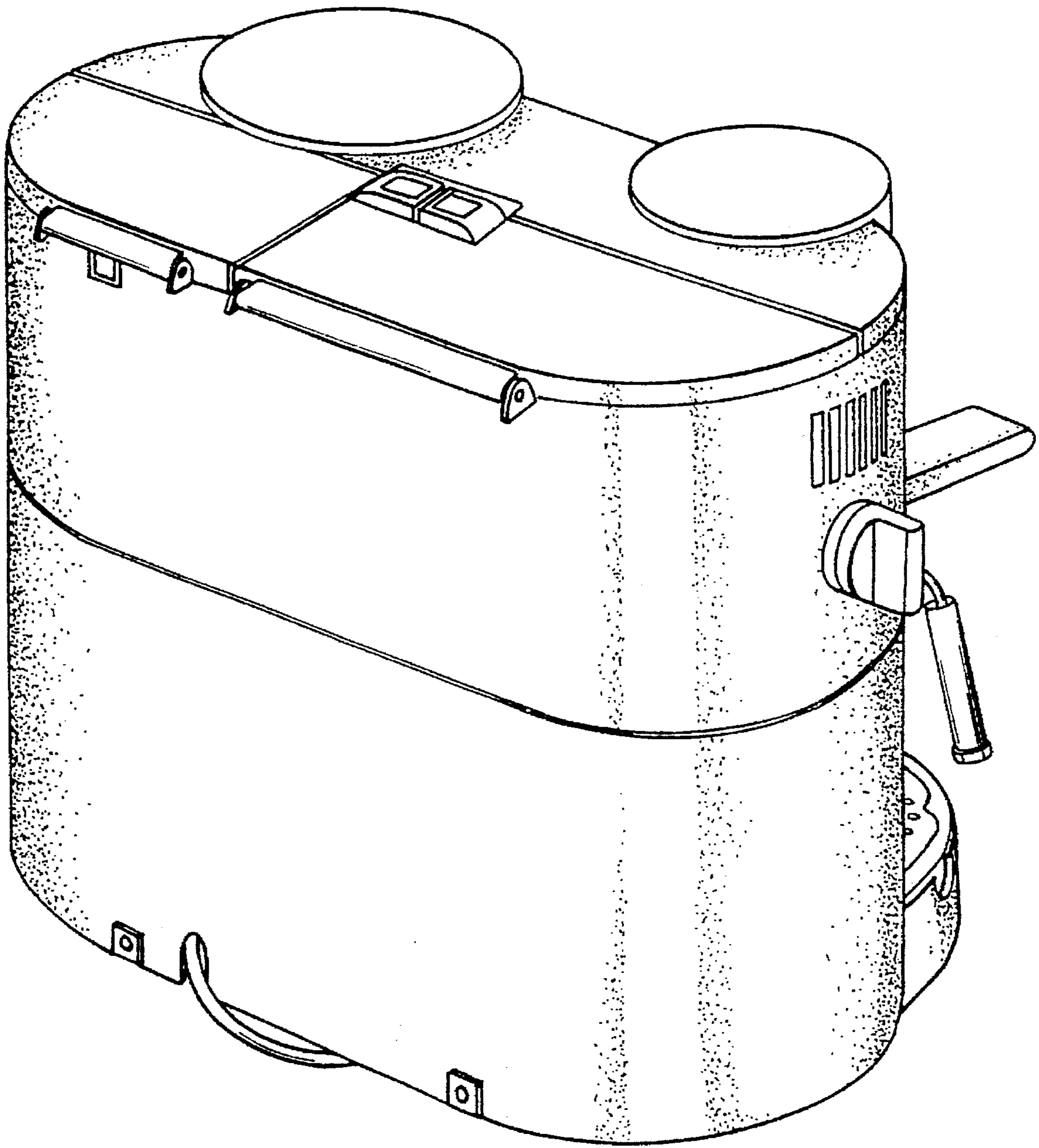

FIG. 4

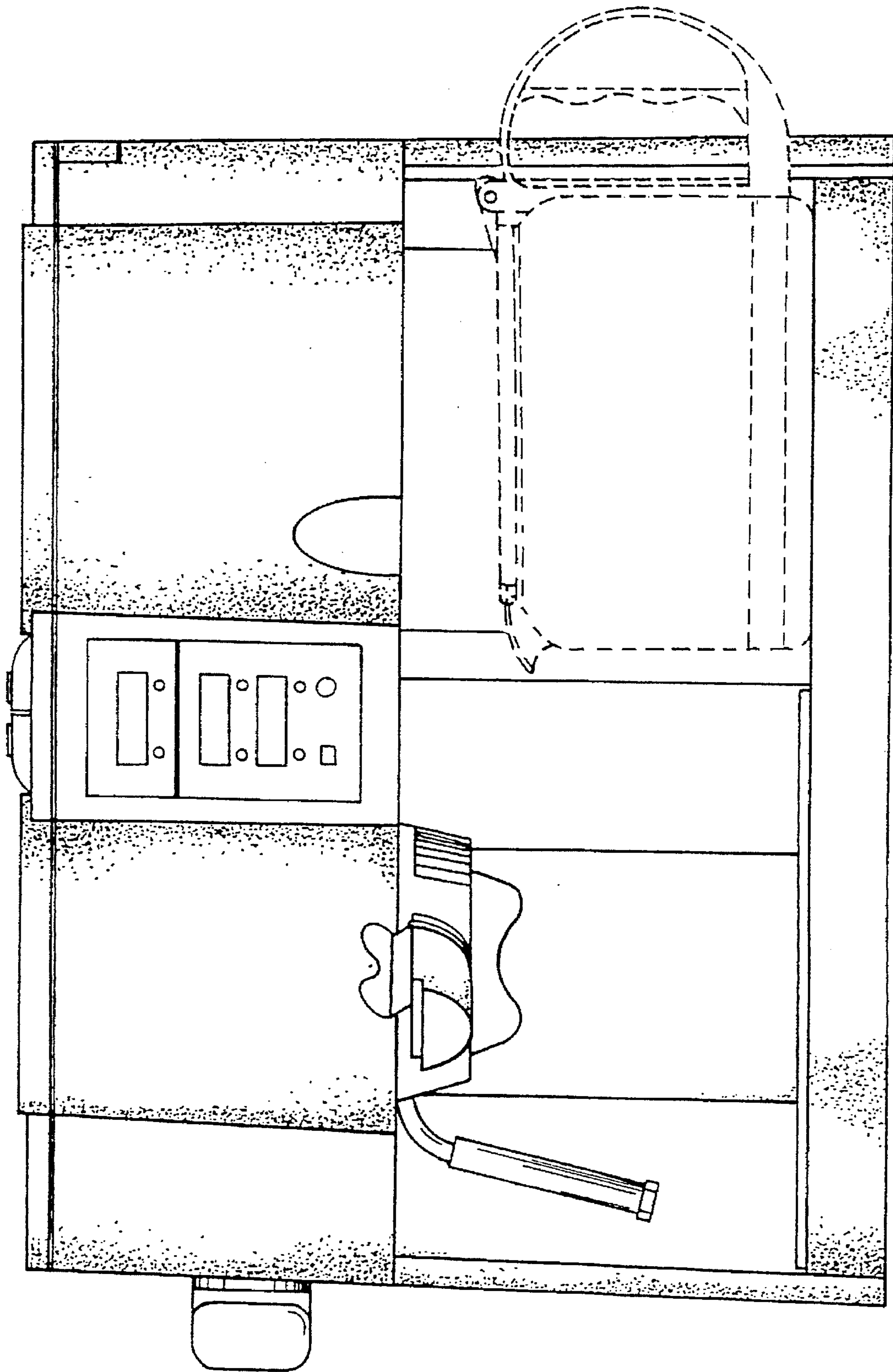

FIG. 5

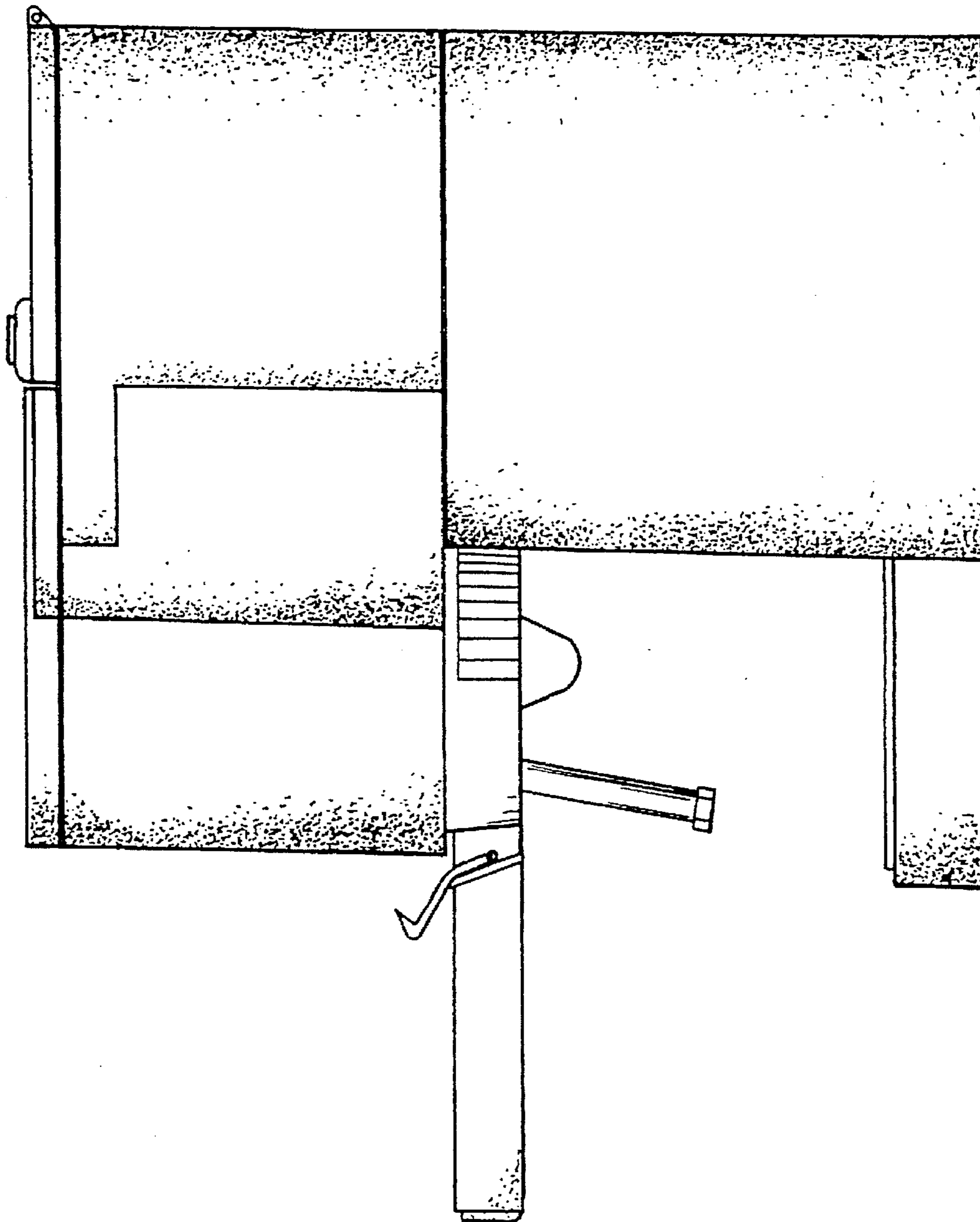

FIG. 6

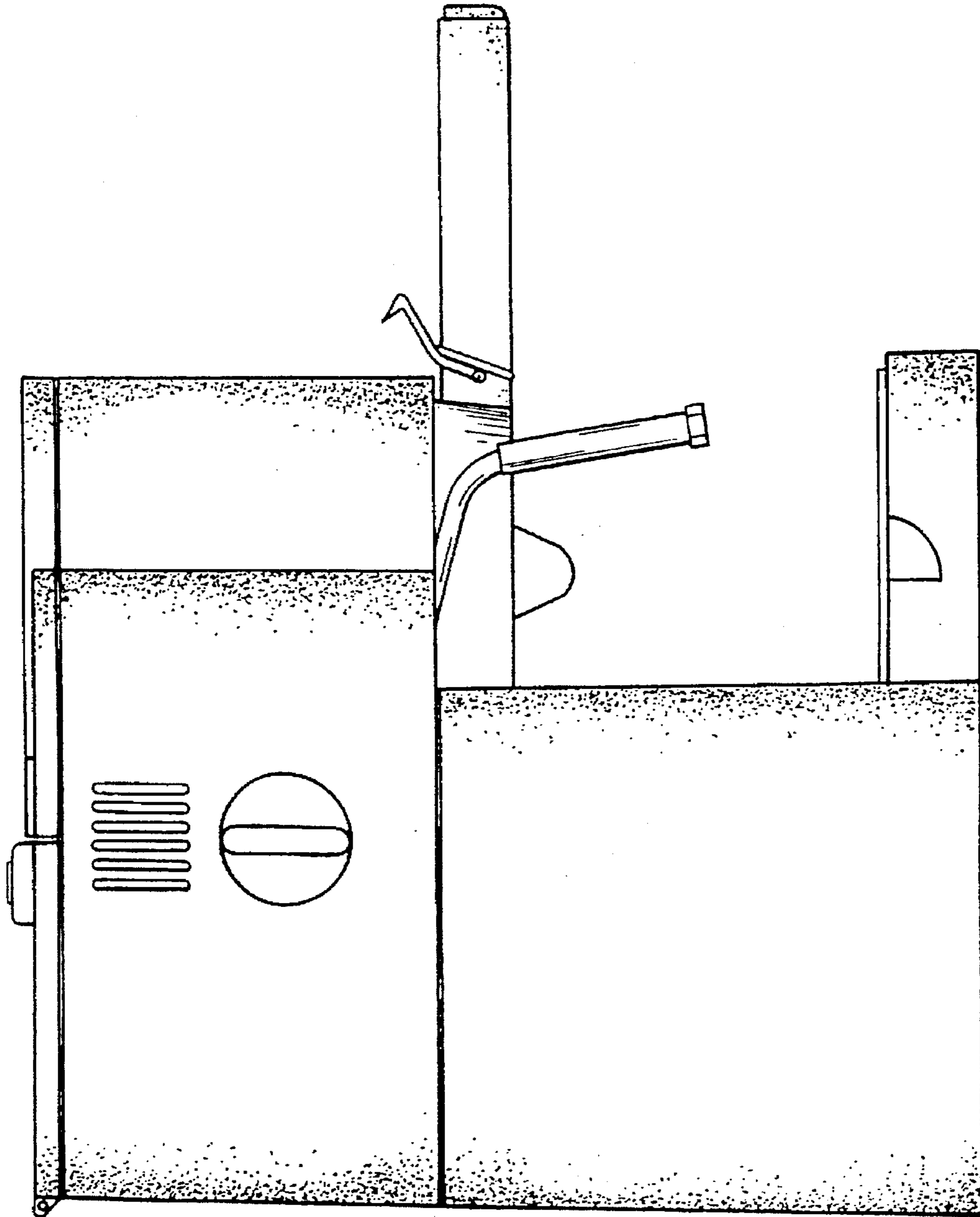

FIG. 7



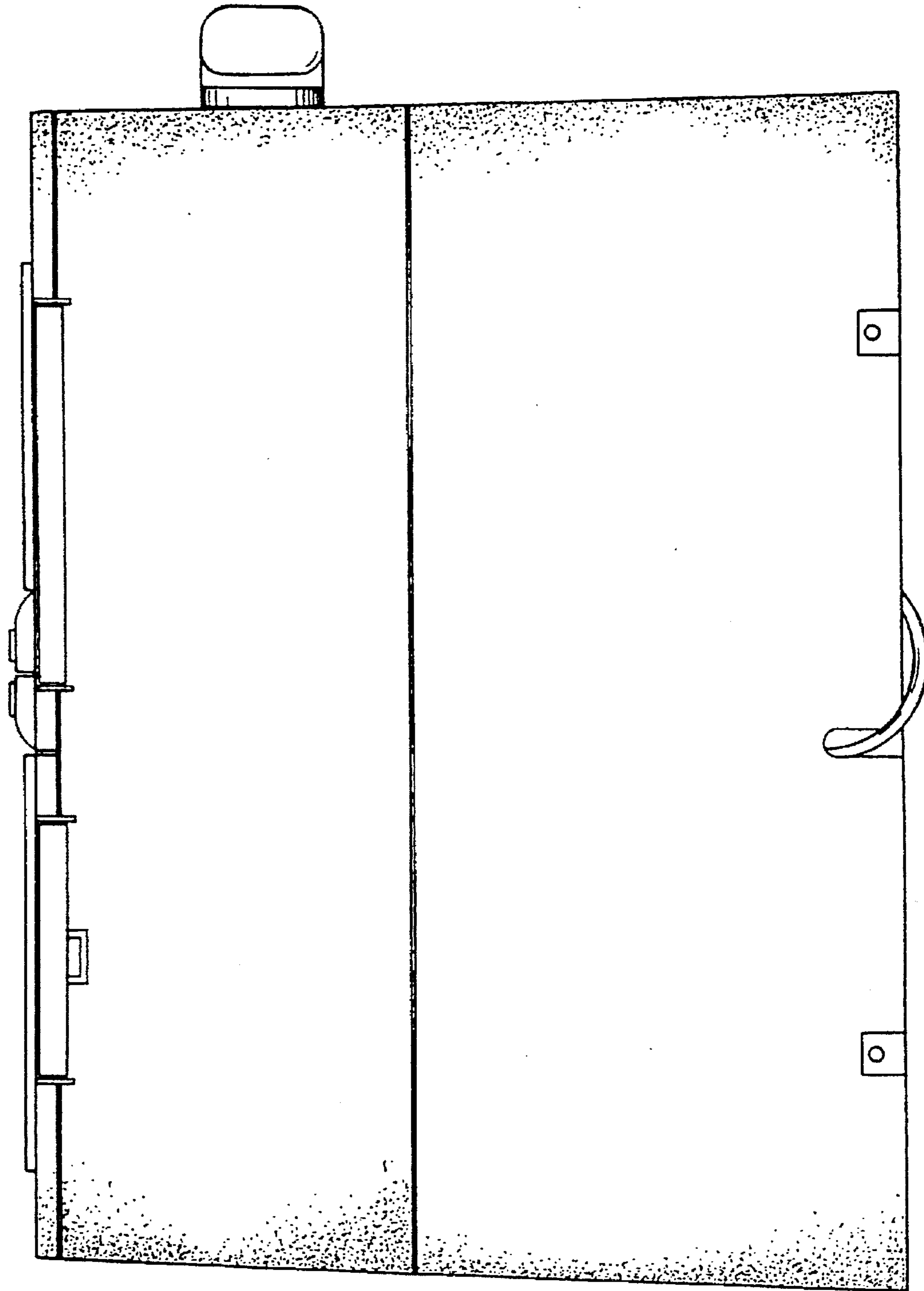

FIG. 8