



US00D382346S

United States Patent [19]

[11] Patent Number: Des. 382,346

Bühler et al.

[45] Date of Patent: **Aug. 12, 1997

[54] VESSEL HOLDER

[75] Inventors: Jürg Bühler, Rothenburg; Siegfried Müller, Meierskappel, both of Switzerland

[73] Assignee: Roche Diagnostic Systems, Inc., Branchburg, N.J.

[**] Term: 14 Years

[21] Appl. No.: 46,605

[22] Filed: Oct. 13, 1995

[30] Foreign Application Priority Data

Apr. 19, 1995 [CH] Switzerland 122241

[51] LOC (6) Cl. 06-04

[52] U.S. Cl. D24/227; D24/230

[58] Field of Search D24/224, 226, D24/229, 230; 211/74, 70.1; 422/102, 104, 65, 63

[56] References Cited

U.S. PATENT DOCUMENTS

D. 333,522	2/1993	Gianino	D24/229
4,022,579	5/1977	Revillet et al.	211/74 X
4,534,465	8/1985	Rothermel et al.	211/74 X
5,186,339	2/1993	Heissler	211/74
5,378,433	1/1995	Duckett et al.	422/104 X
5,427,743	6/1995	Markin	211/74 X
5,525,304	6/1996	Matsson et al.	211/74 X

Primary Examiner—Louis S. Zarfes

Assistant Examiner—I. Simmons

Attorney, Agent, or Firm—George W. Johnston; Ellen Ciambone Coletti; Robert A. Silverman

[57] CLAIM

The ornamental design for a vessel holder, as shown and described.

DESCRIPTION

FIG. 1 is a rear, right side and top perspective view of a vessel holder showing our new design;

FIG. 2 is a front, left side and top perspective view thereof;

FIG. 3 is a right side elevational view thereof;

FIG. 4 is a left side elevational view thereof;

FIG. 5 is a front elevational view thereof;

FIG. 6 is a rear elevational view thereof;

FIG. 7 is a top plan view thereof;

FIG. 8 is a bottom plan view thereof;

FIG. 9 is an exploded front, left side and top perspective view thereof;

FIG. 10 is a rear, right side and top perspective view of a second embodiment of a vessel holder showing our new design;

FIG. 11 is a front, left side and top perspective view thereof;

FIG. 12 is a right side elevational view thereof;

FIG. 13 is a left side elevational view thereof;

FIG. 14 is a front elevational view thereof;

FIG. 15 is a rear elevational view thereof;

FIG. 16 is a top plan view thereof;

FIG. 17 is a bottom plan view thereof;

FIG. 18 is an exploded front, left side and top perspective view thereof;

FIG. 19 is a rear, right side and top perspective view of a vessel holder showing our new design;

FIG. 20 is a front, left side and top perspective view thereof;

FIG. 21 is a right side elevational view thereof;

FIG. 22 is a left side elevational view thereof;

FIG. 23 is a front elevational view thereof;

FIG. 24 is a rear elevational view thereof;

FIG. 25 is a top plan view thereof;

FIG. 26 is a bottom plan view thereof; and,

FIG. 27 is an exploded front, left side and top perspective view thereof.

The broken line showing of the cuvette in the FIGS. 9, 18, 19 through 26 and 27 are for illustrative purposes only and forms no part of the claimed design.

1 Claim, 21 Drawing Sheets

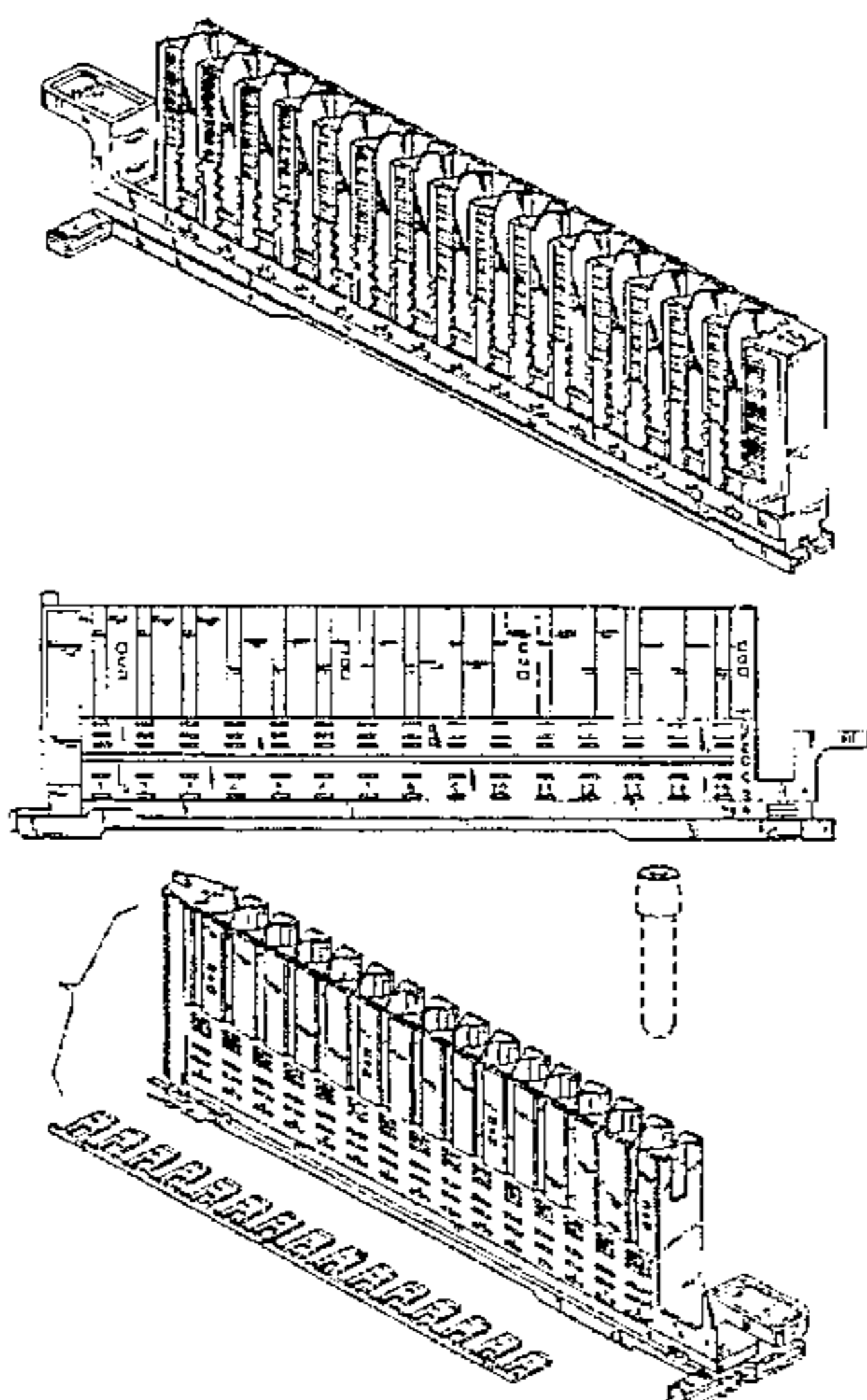

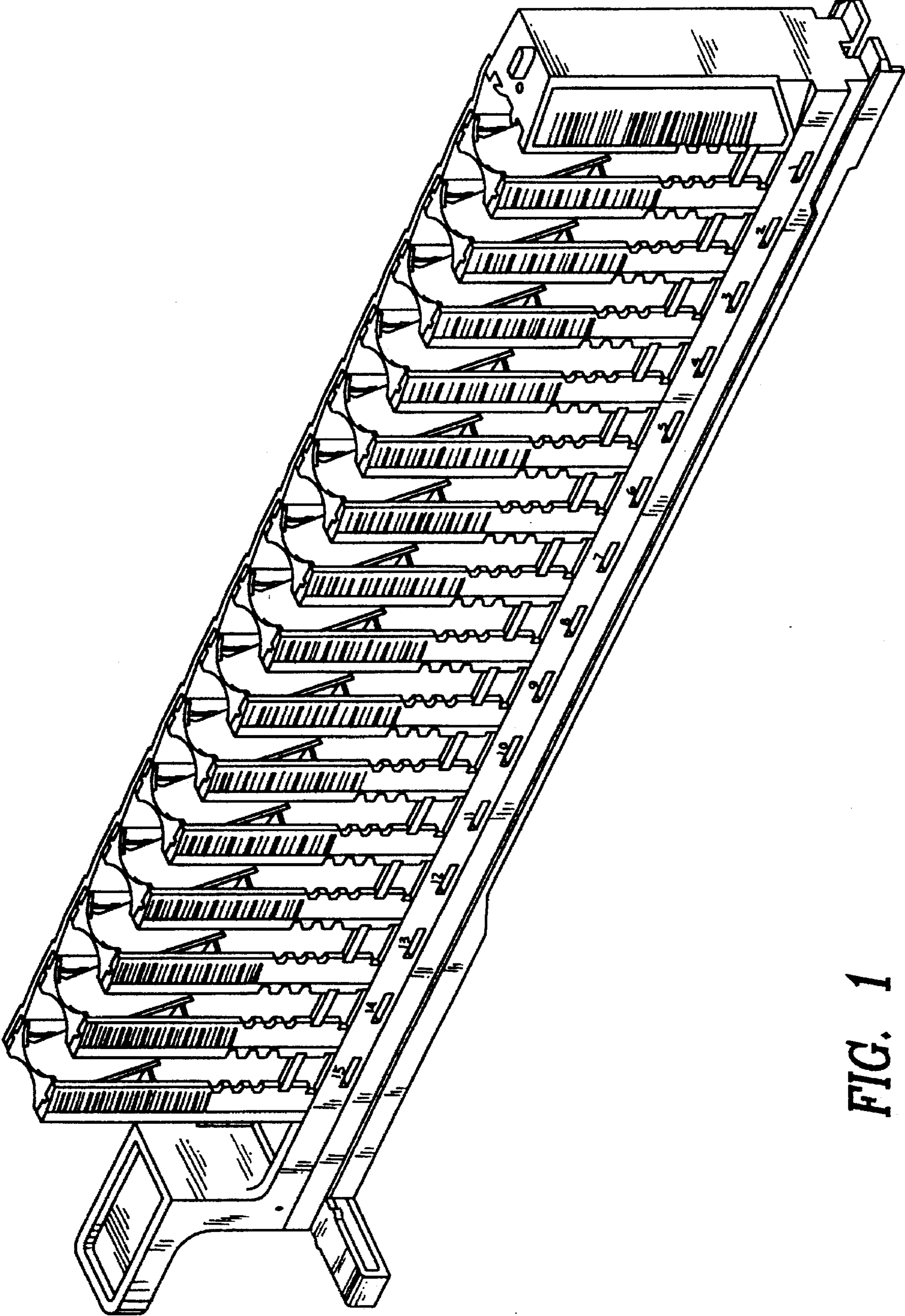

FIG. 1

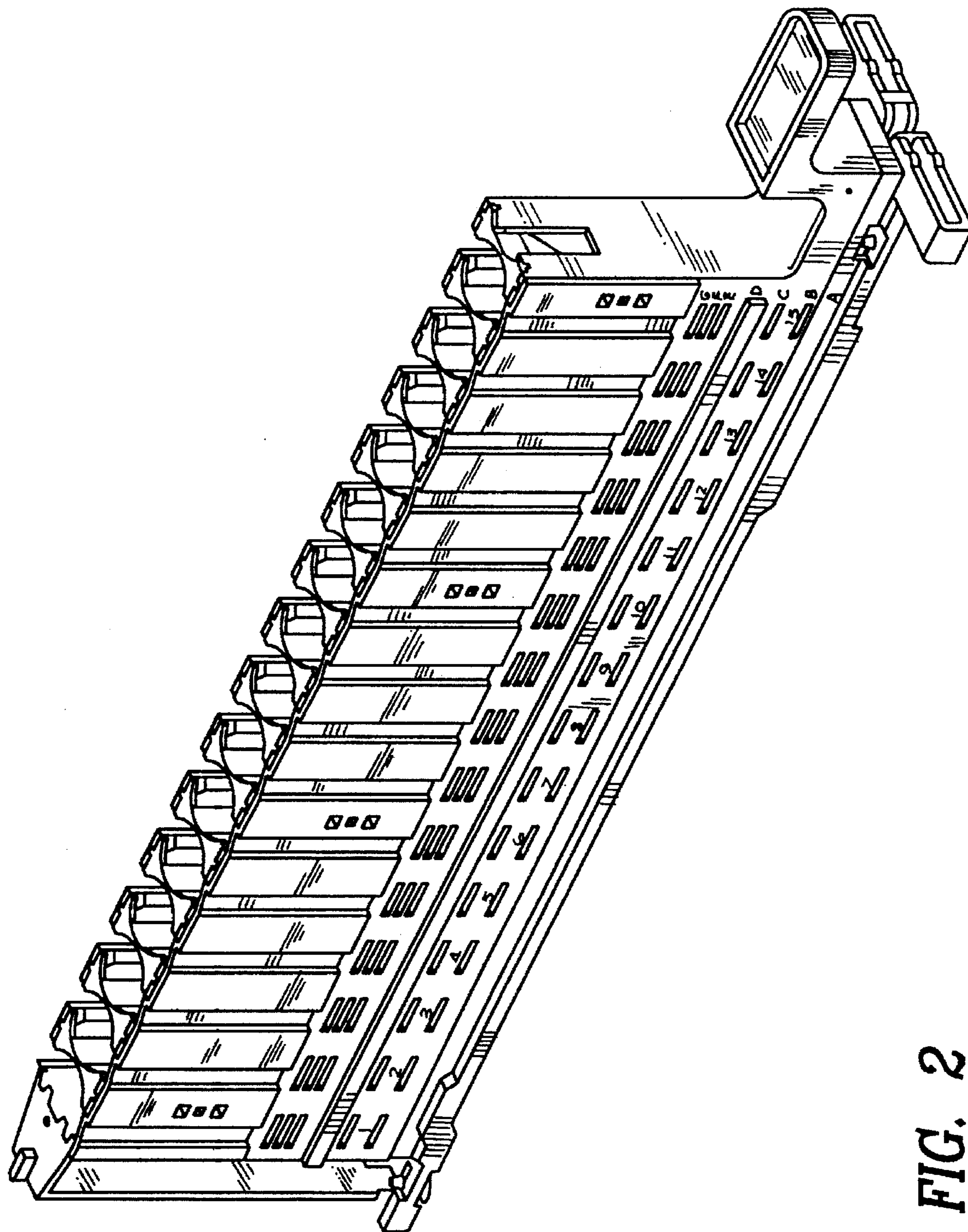

FIG. 2

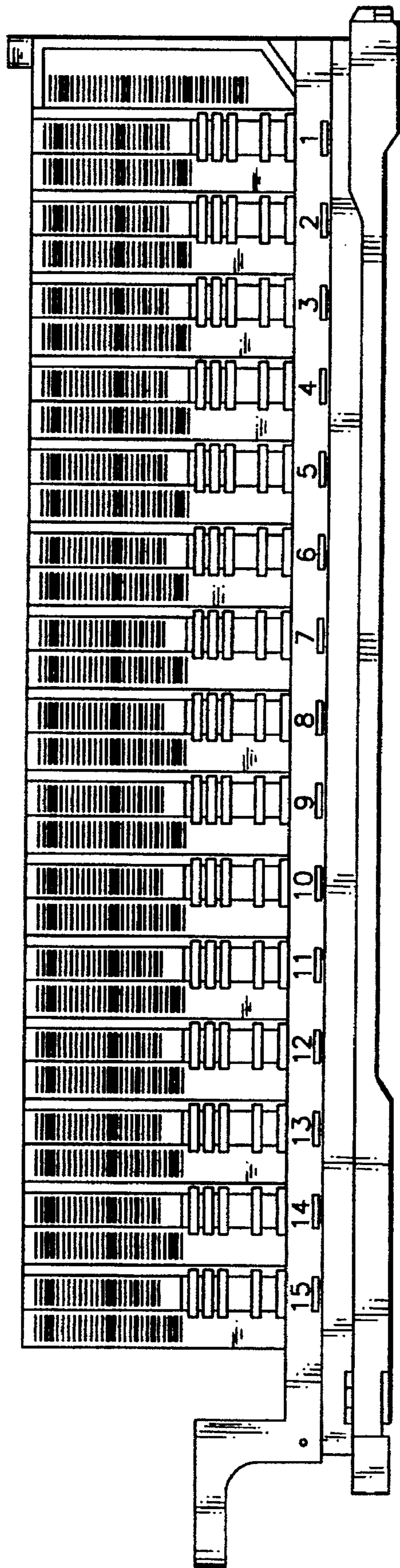

FIG. 3

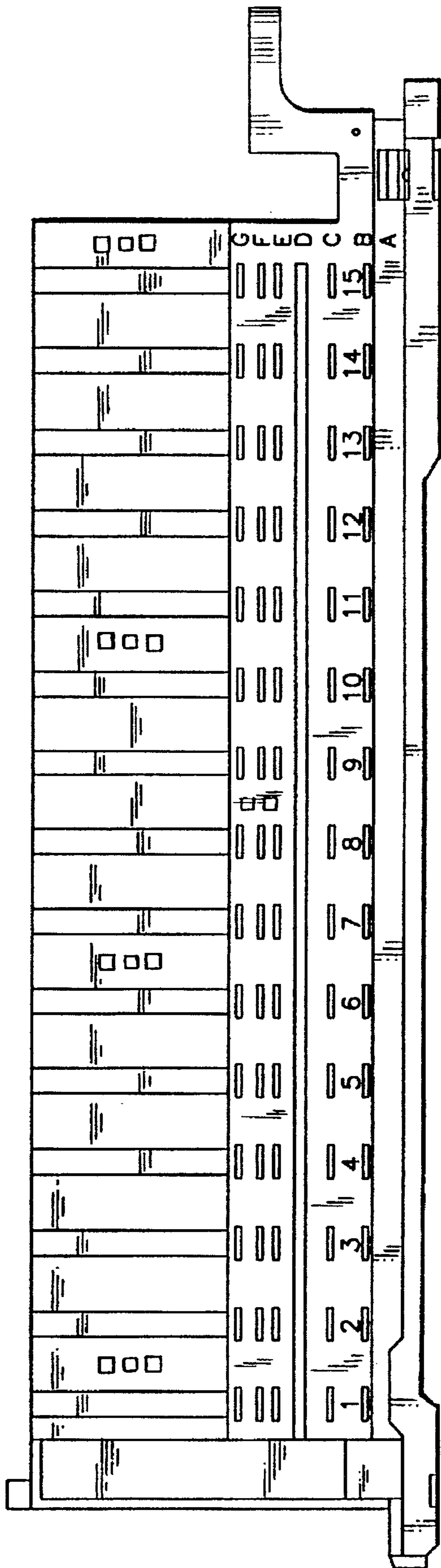

FIG. 4

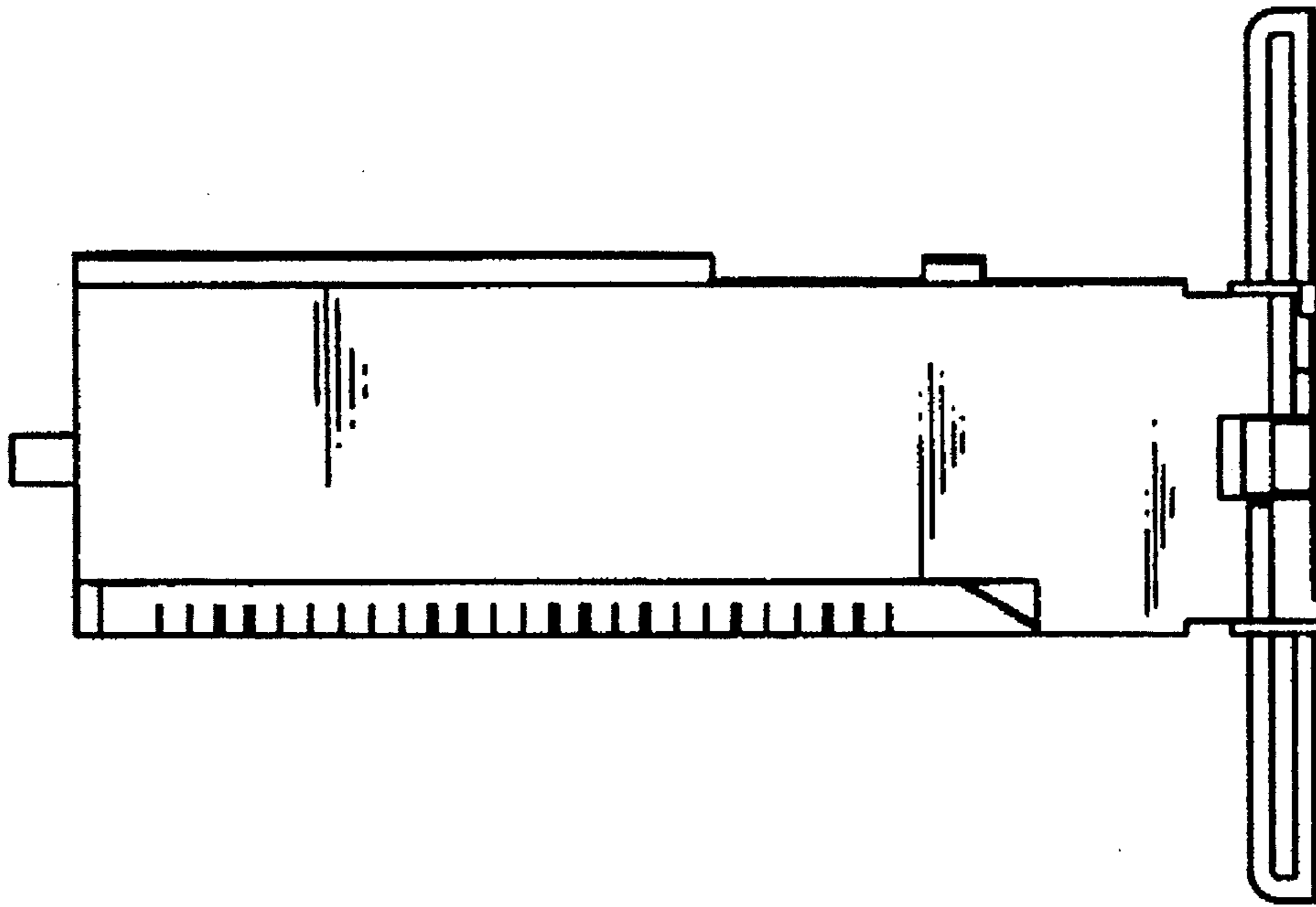

FIG. 6

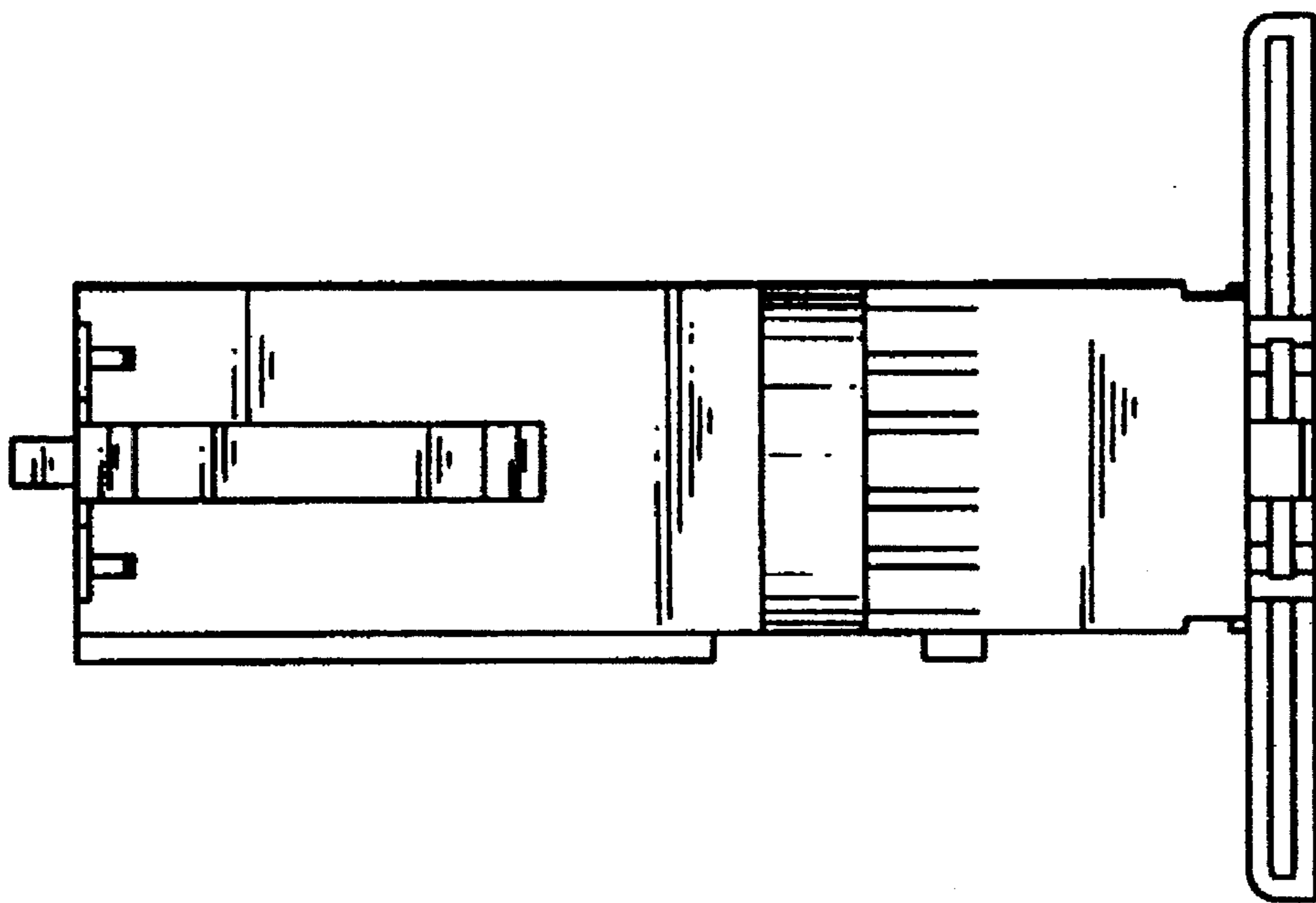

FIG. 5

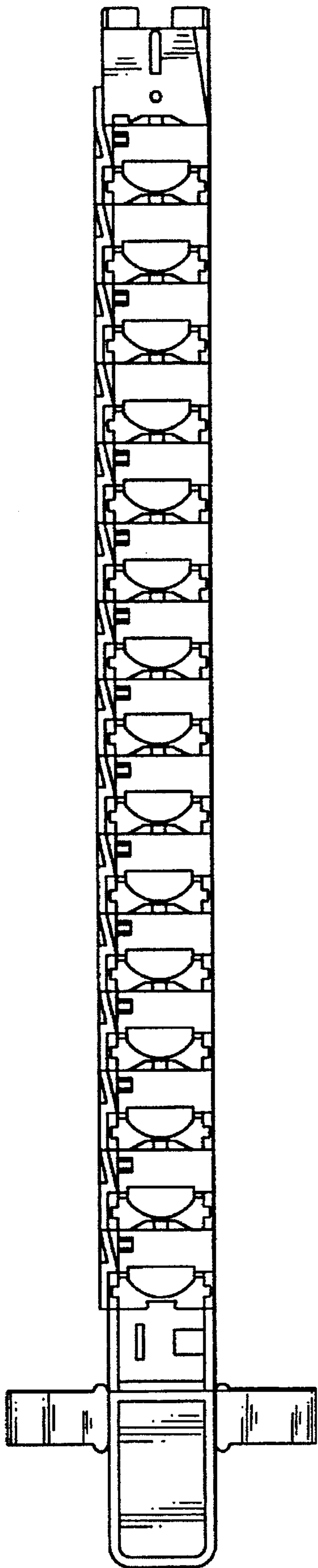

FIG. 7

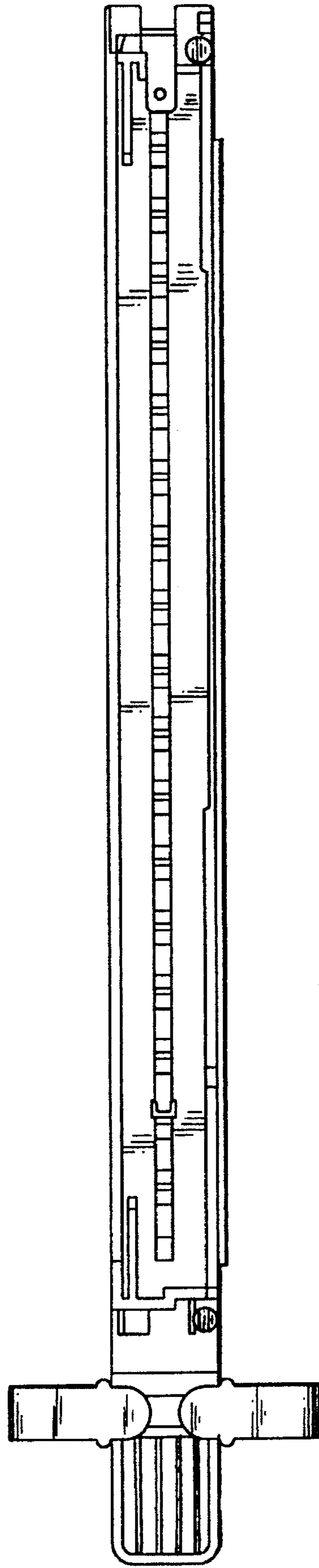

FIG. 8

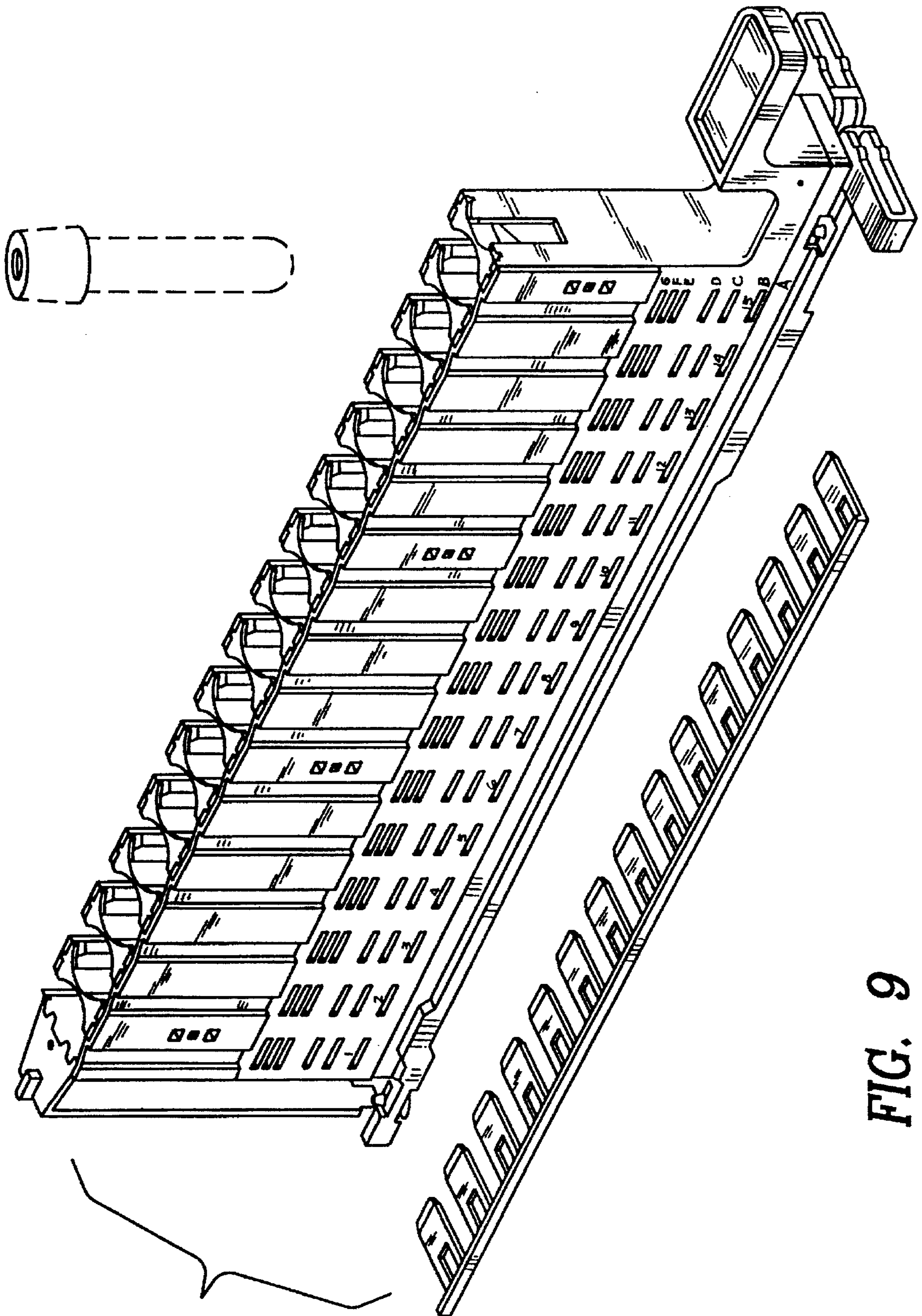

FIG. 9

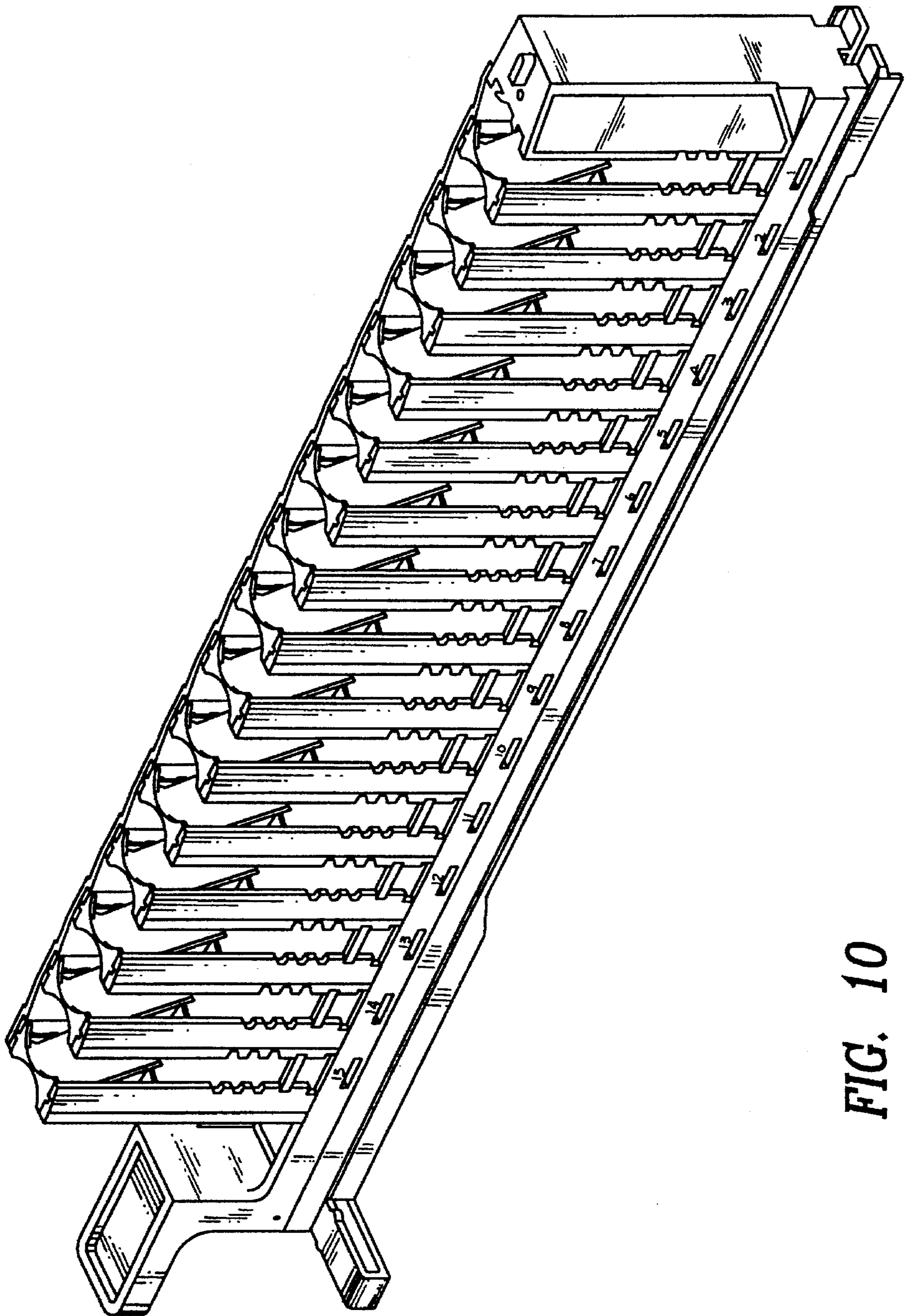

FIG. 10

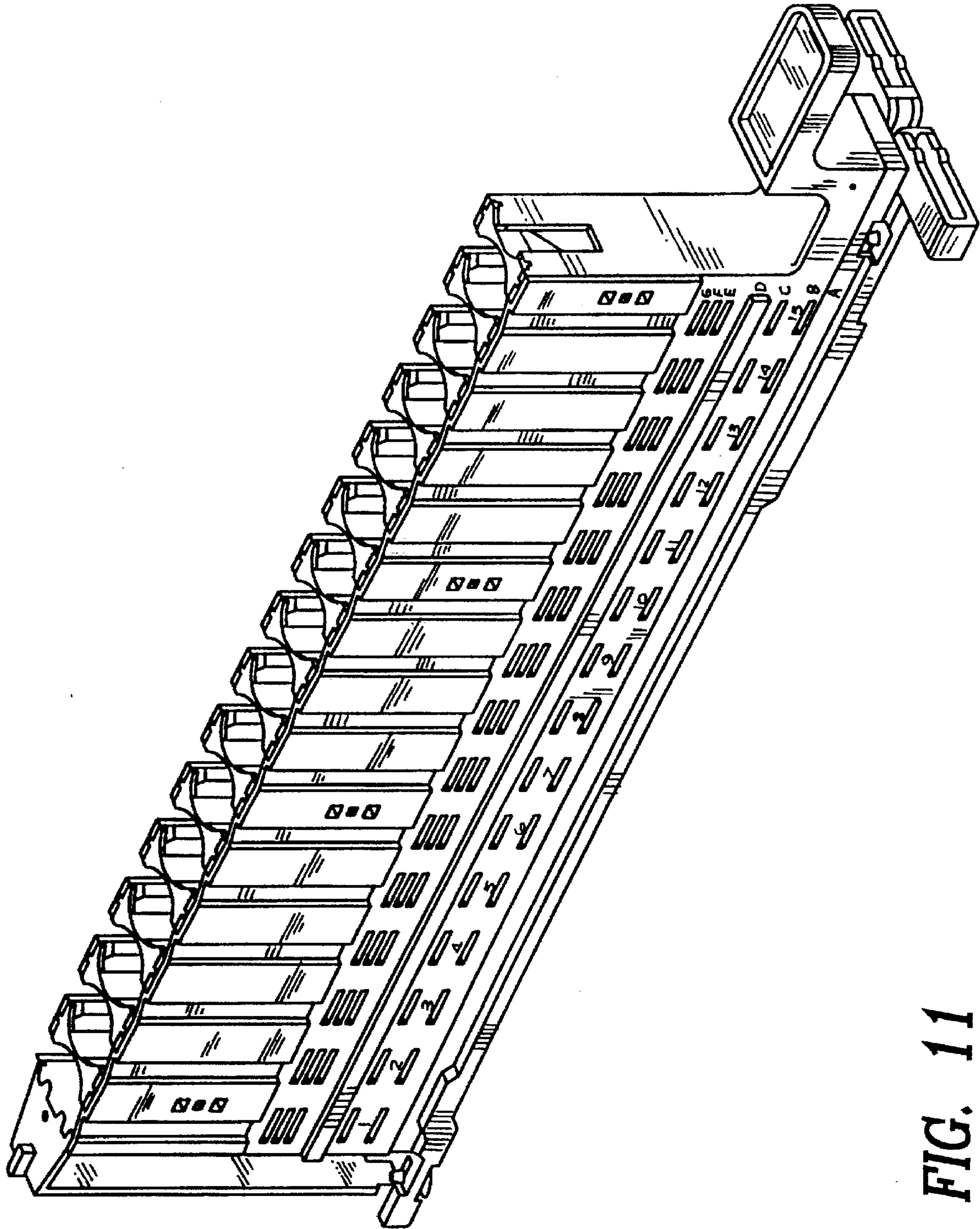

FIG. 11

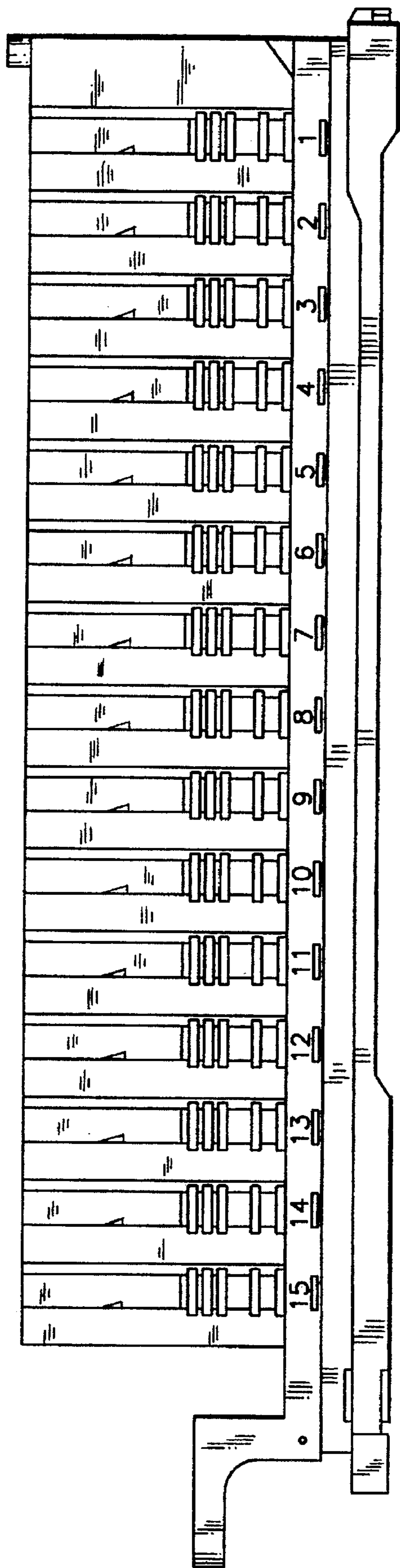

FIG. 12

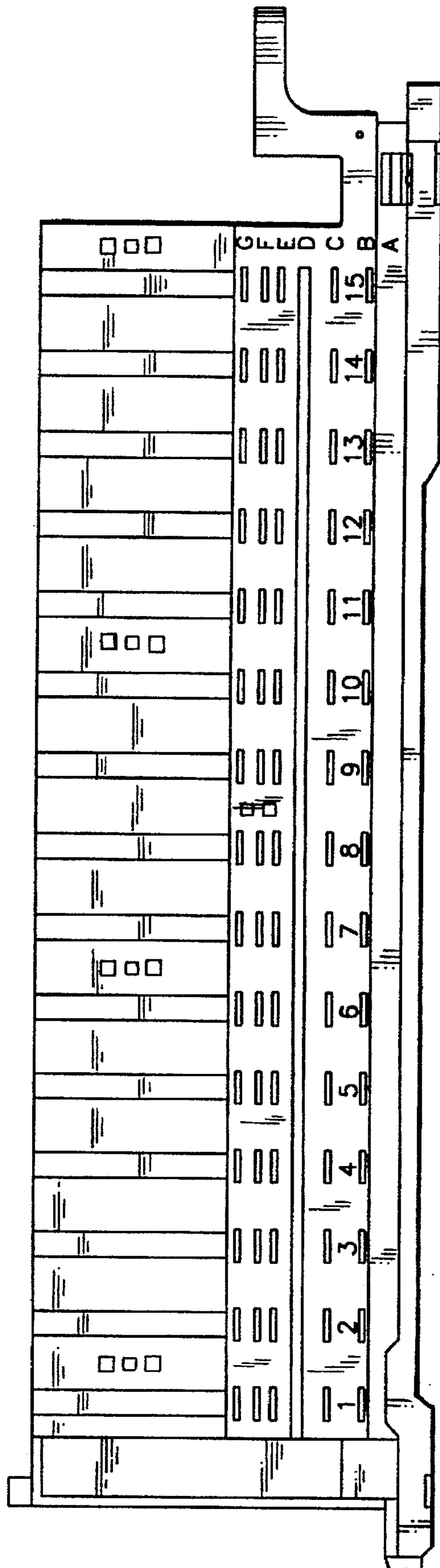

FIG. 13

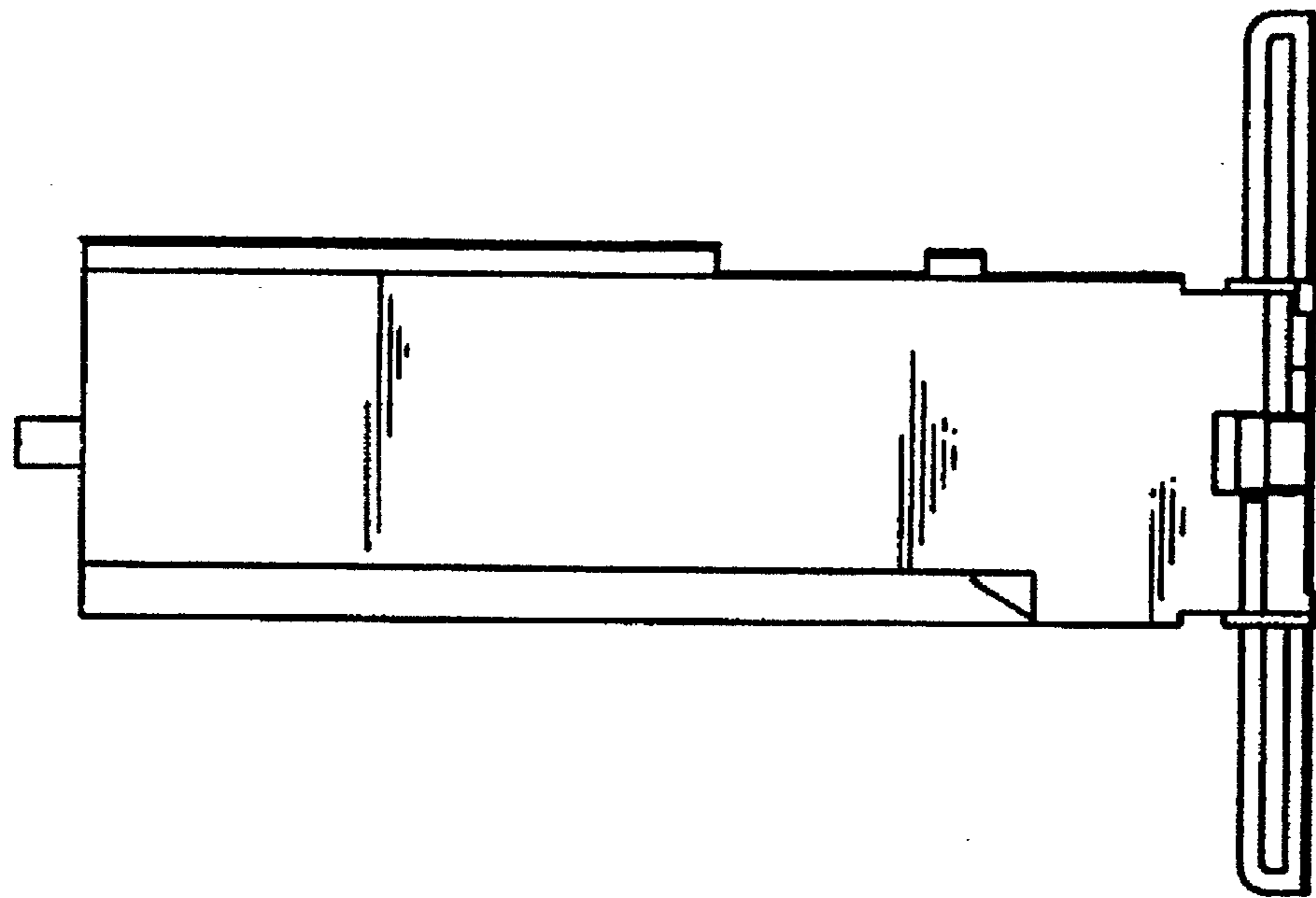

FIG. 15

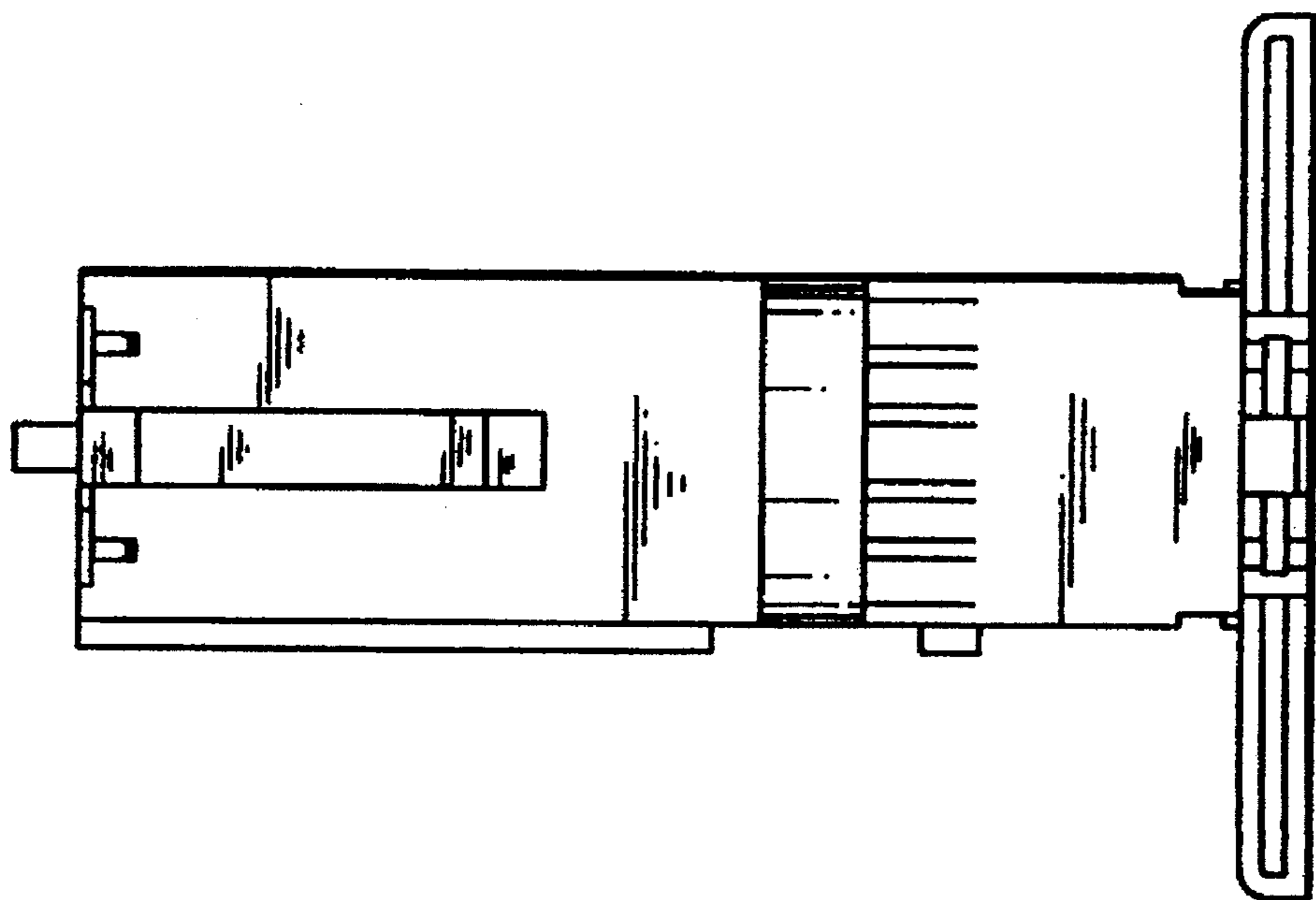

FIG. 14

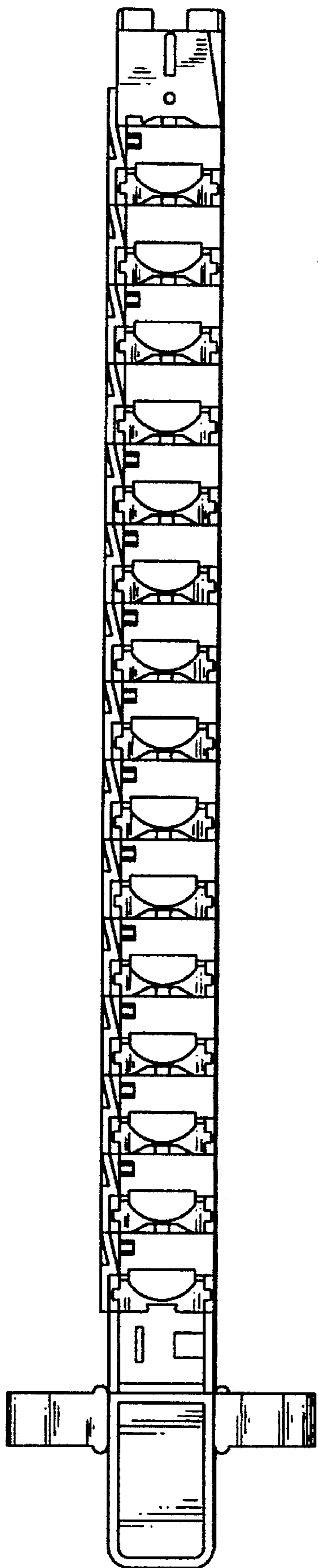

FIG. 16

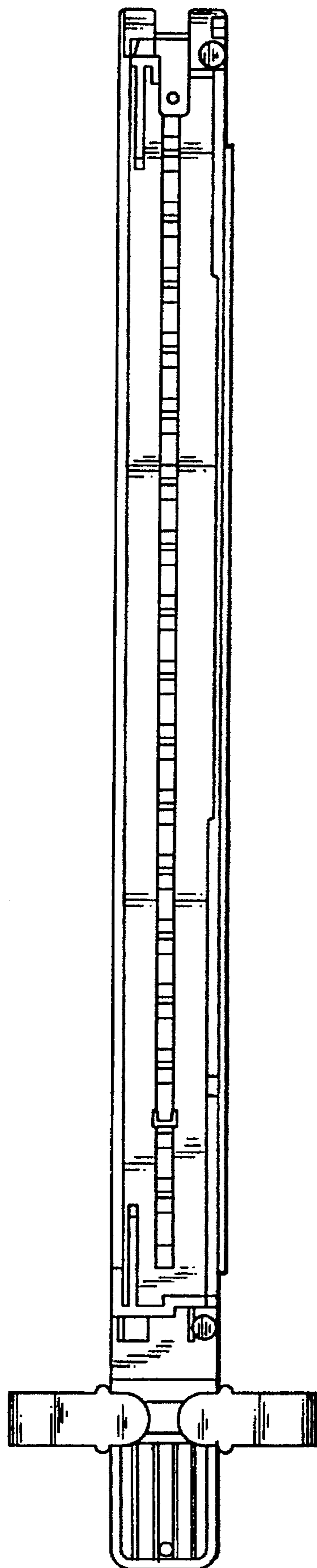

FIG. 17

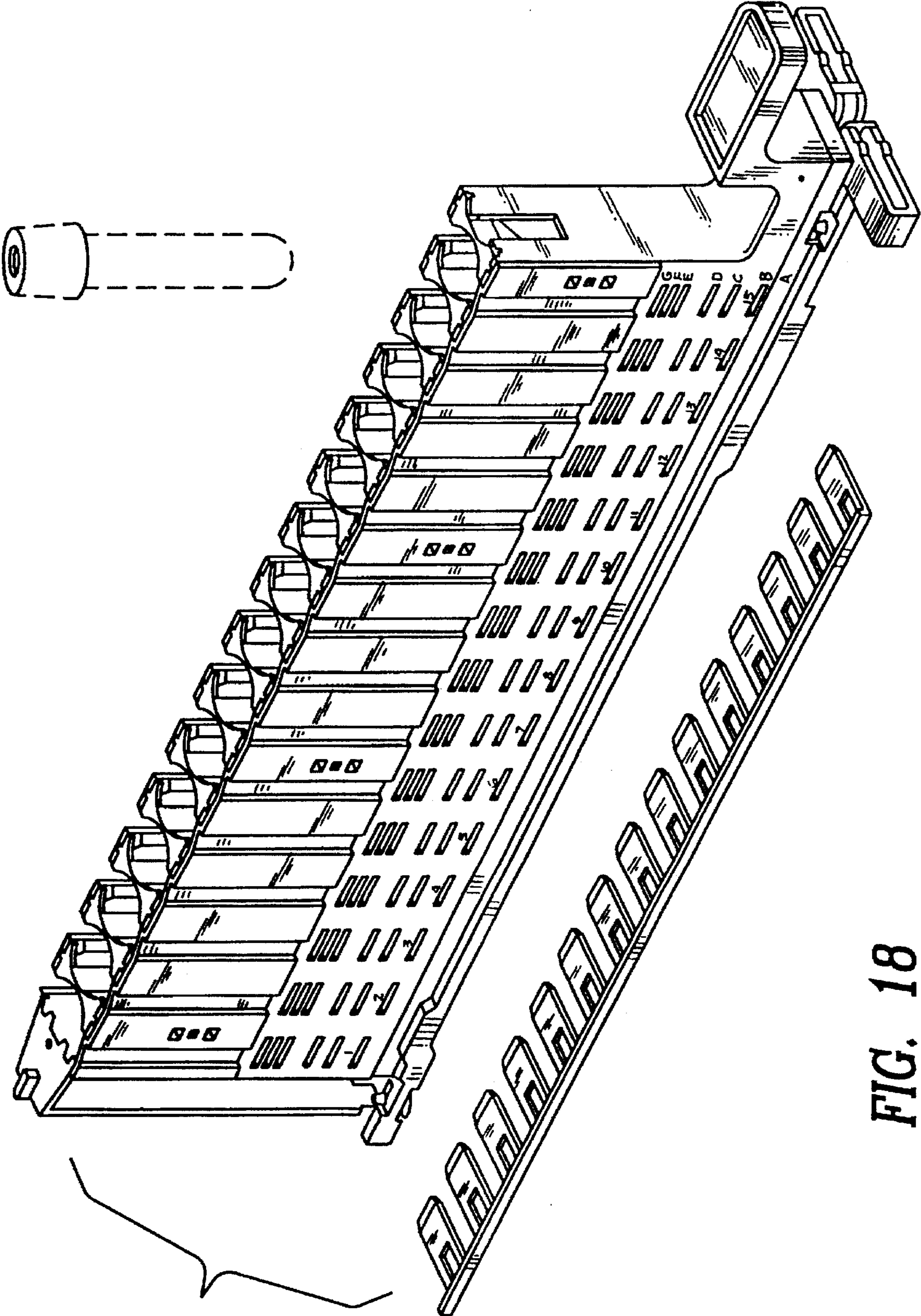

FIG. 18

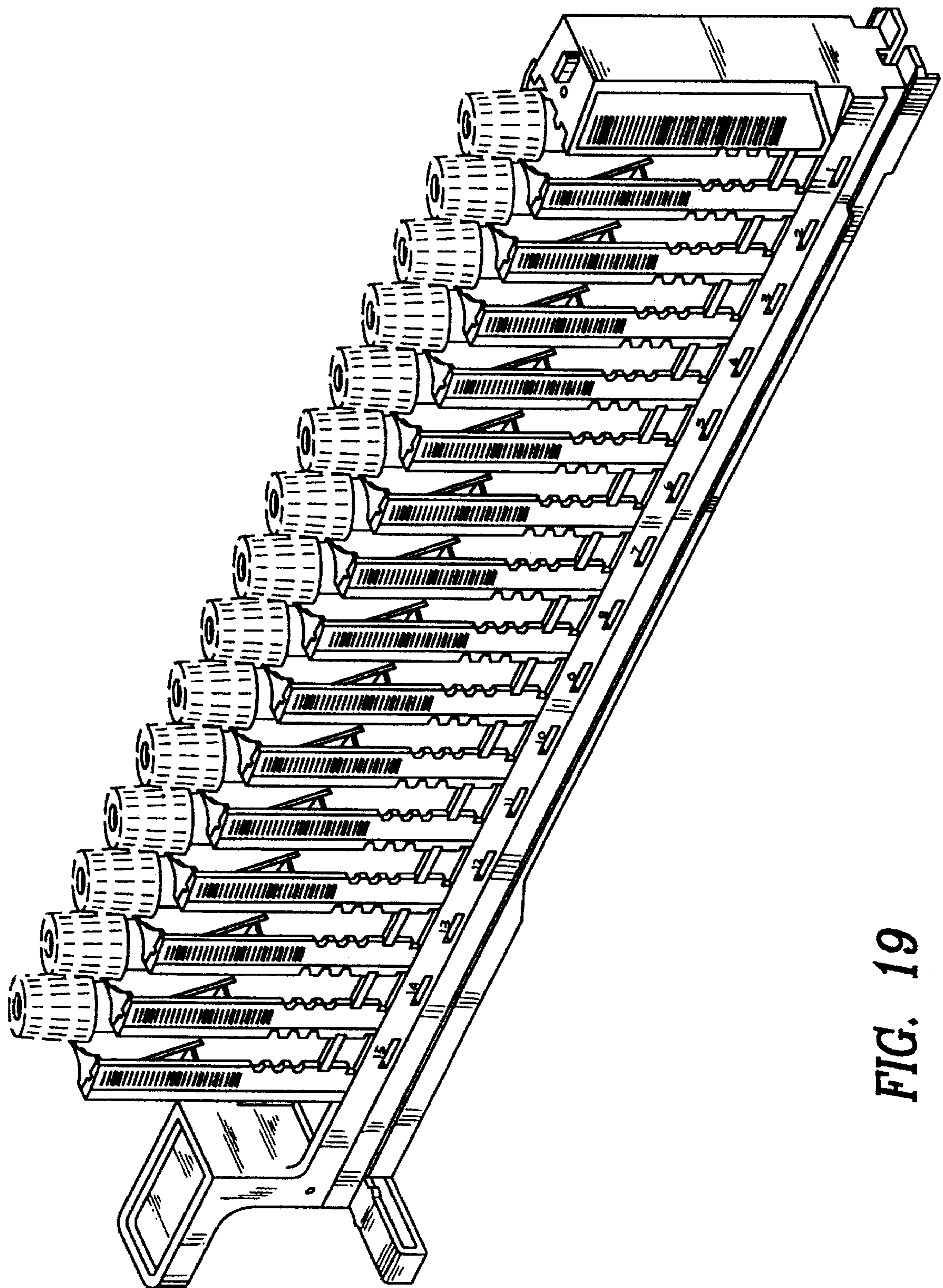

FIG. 19

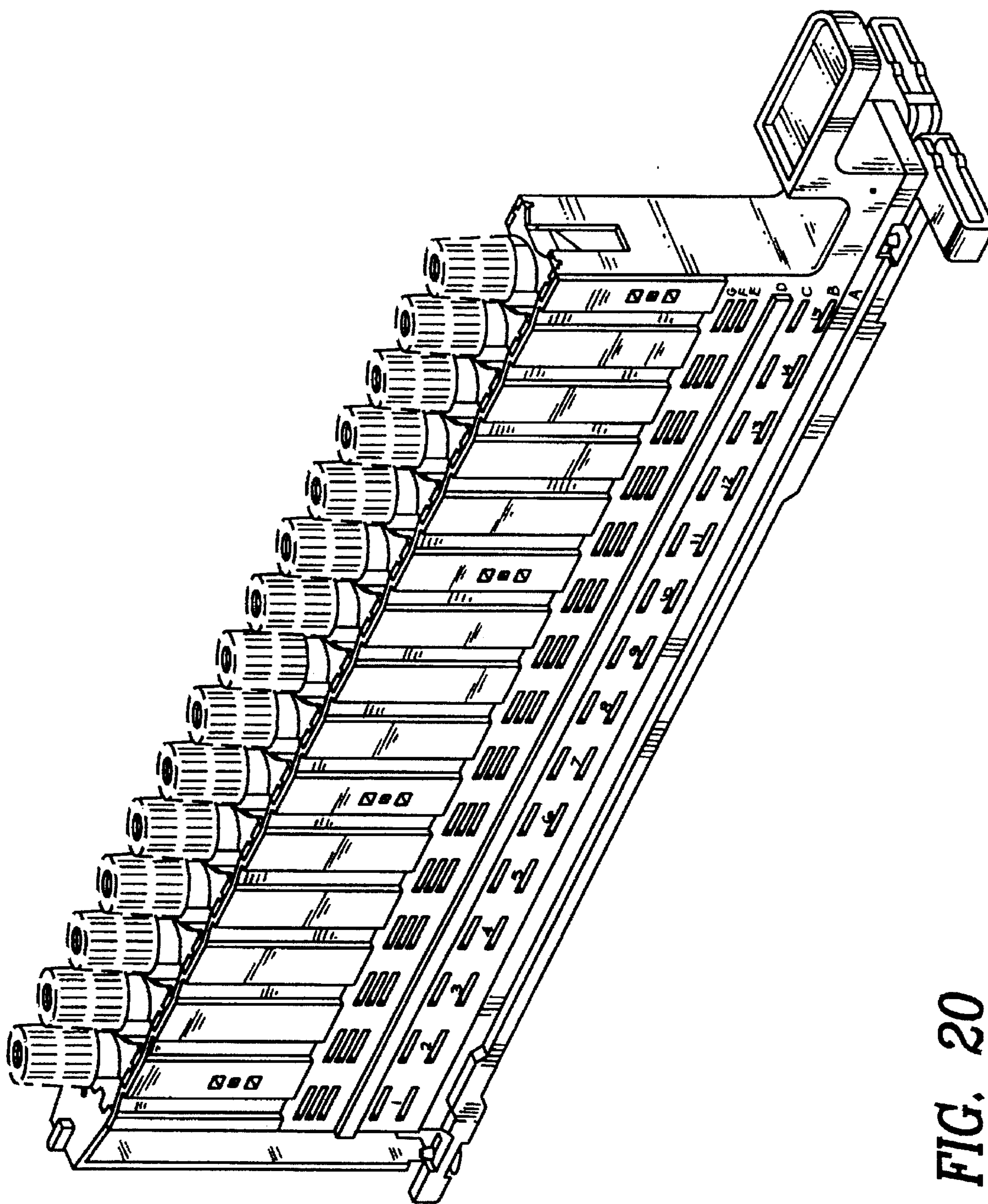

FIG. 20

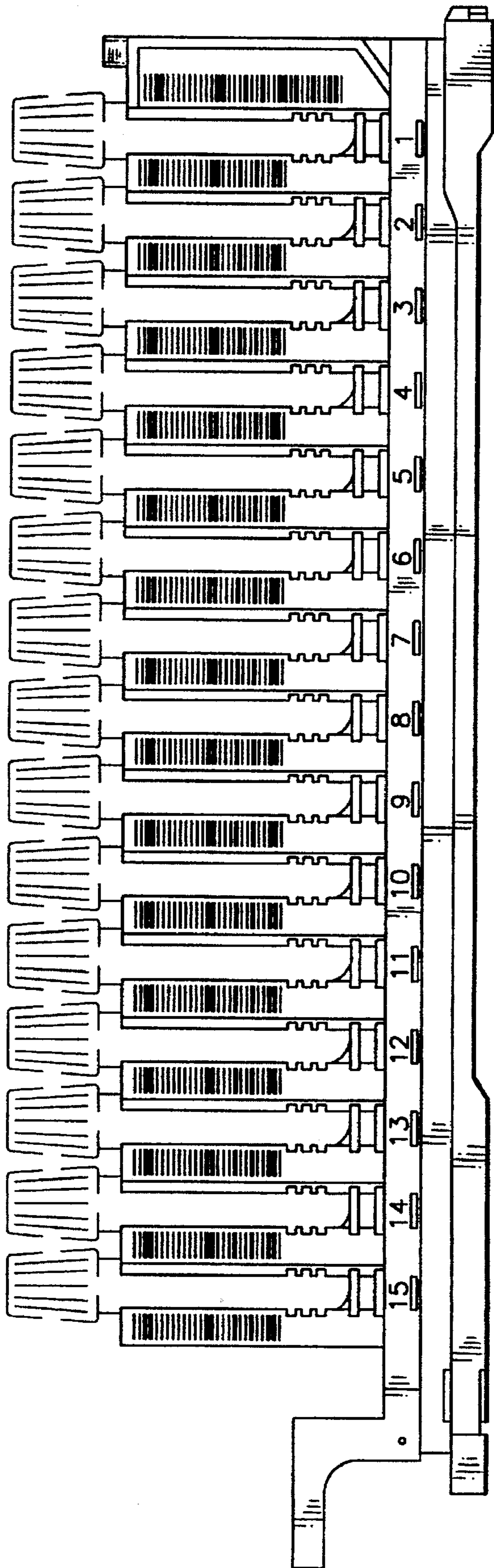

FIG. 21

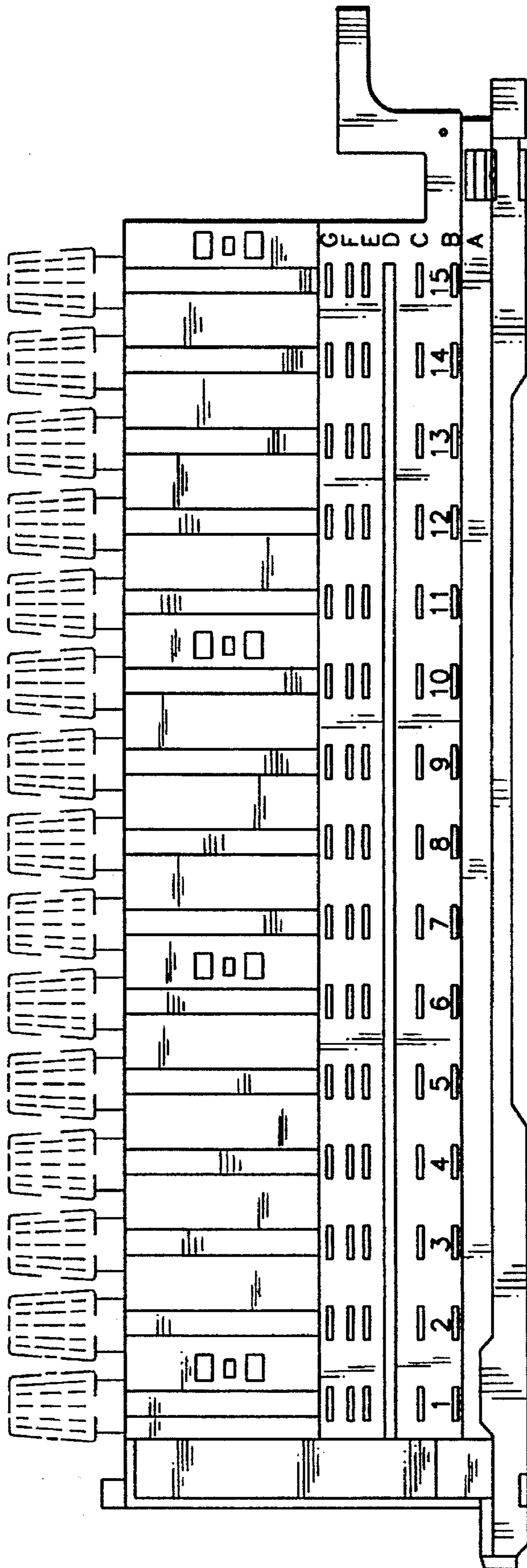

FIG. 22

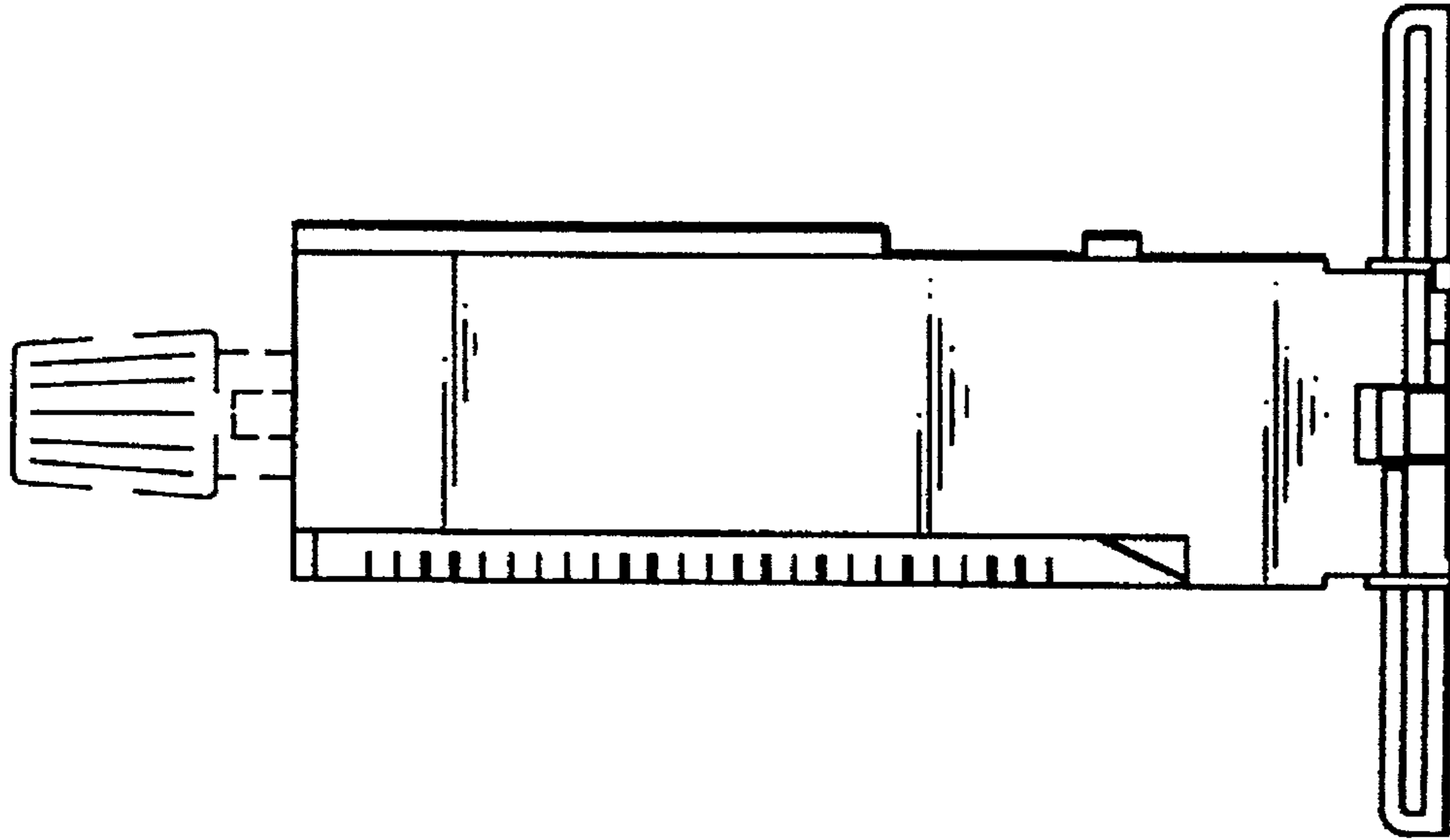

FIG. 24

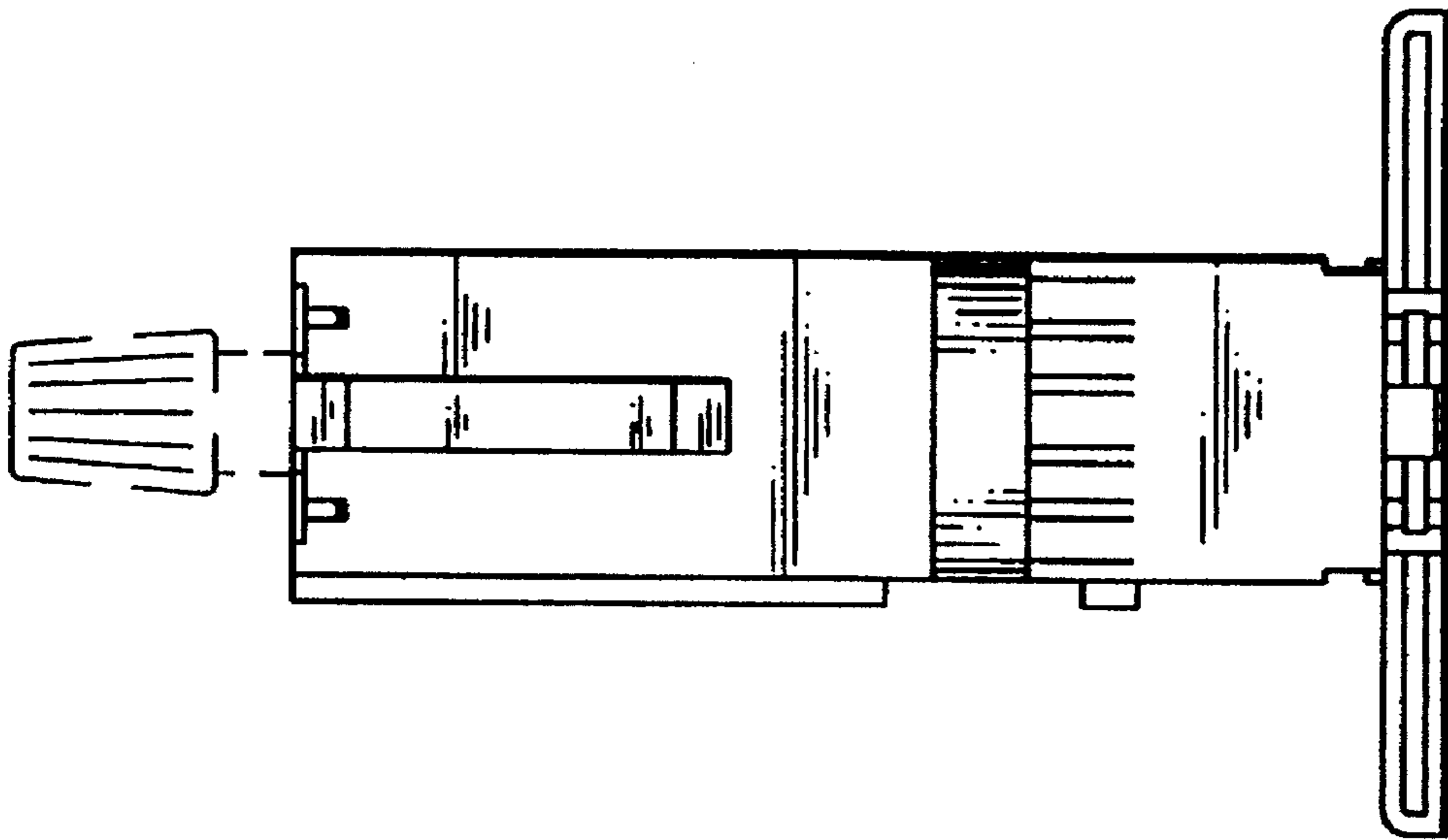

FIG. 23

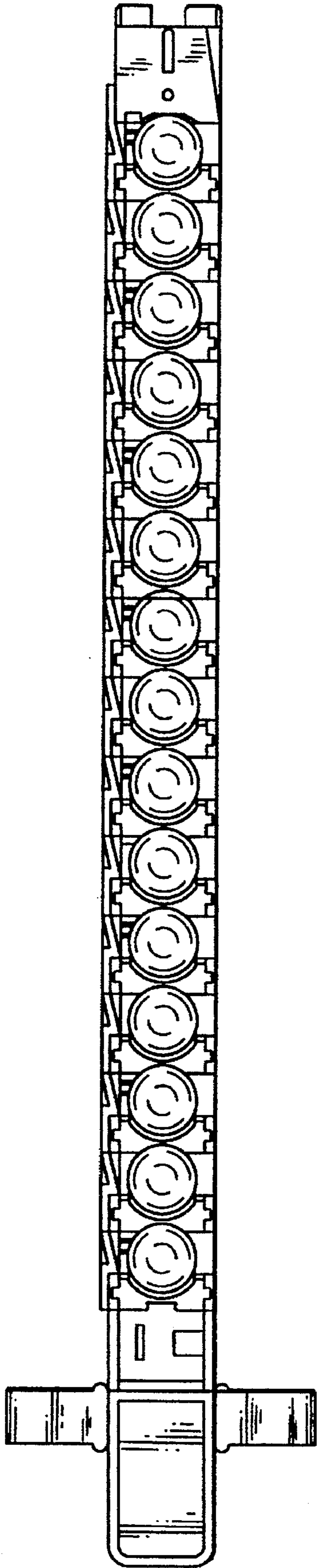

FIG. 25

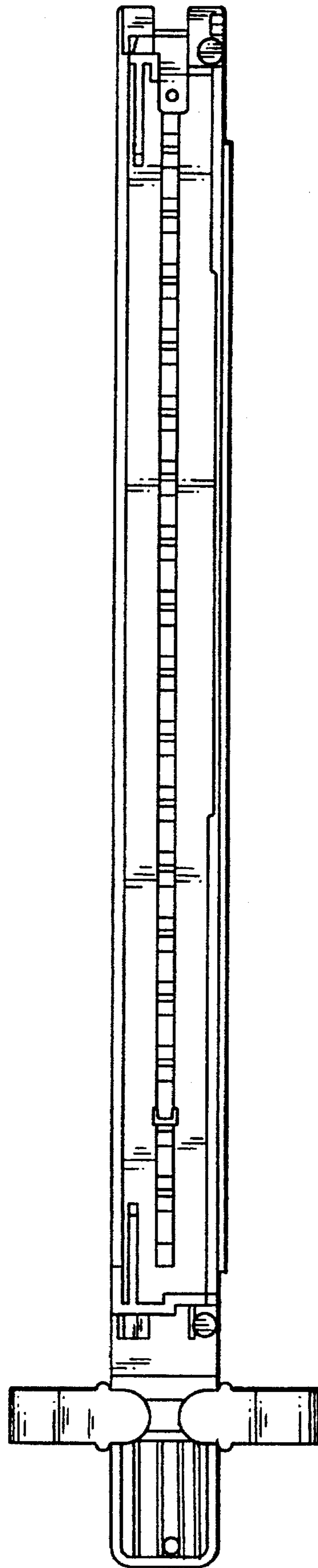

FIG. 26

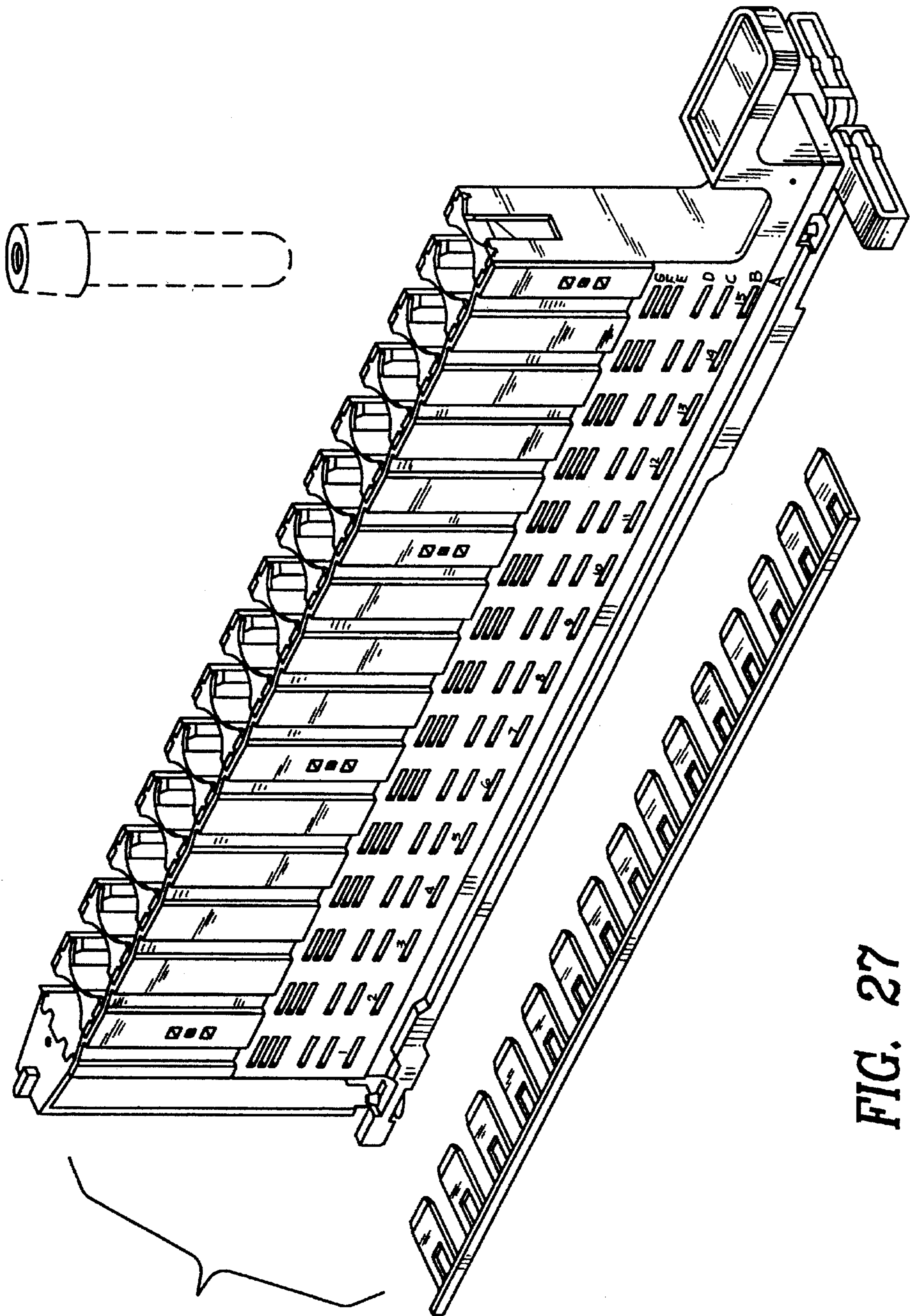

FIG. 27