



US00D382333S

United States Patent [19]

[11] Patent Number: **Des. 382,333**

Kawamura et al.

[45] Date of Patent: ****Aug. 12, 1997**

[54] **COMBINED TOILET BASIN, TOILET SEAT AND SEAT COVER**

[75] Inventors: **Seijiro Kawamura; Noriko Yoshii Hashida**, both of Kitakyushu, Japan

[73] Assignee: **Toto Ltd.**, Japan

[**] Term: **14 Years**

[21] Appl. No.: **48,054**

[22] Filed: **Dec. 19, 1995**

Related U.S. Application Data

[62] Division of Ser. No. 25,077, Jun. 27, 1994, Pat. No. Des. 369,401.

[51] LOC (6) Cl. **23-02**

[52] U.S. Cl. **D23/295**

[58] Field of Search D23/295, 298, D23/299, 300, 301; 4/353, 421, 424, 428, 430

[56] References Cited

U.S. PATENT DOCUMENTS

- D. 92,215 5/1934 Teahen D23/201
- D. 195,327 6/1963 Lee D23/299
- D. 233,150 10/1974 Workman D23/299

- D. 250,202 11/1978 Doman et al. D23/301
- D. 268,779 4/1983 Doman .
- D. 275,515 9/1984 Kaiser .
- D. 275,599 9/1984 Enthoven .
- D. 288,588 3/1987 Stairs, Jr. .
- D. 288,589 3/1987 Stairs, Jr. .
- D. 288,590 3/1987 Stairs, Jr. .
- D. 311,242 10/1990 Reid D23/201

Primary Examiner—Stella Reid
Assistant Examiner—Eric Watterson
Attorney, Agent, or Firm—Finnegan, Henderson, Farabow, Garrett & Dunner, L.L.P.

[57] CLAIM

The ornamental design for a combined toilet basin, toilet seat and seat cover, as shown and described.

DESCRIPTION

FIG. 1 is a right side elevational view of a combined toilet basin, toilet seat, and seat cover showing my new design, the opposite side being a mirror image;
 FIG. 2 is a rear elevational view;
 FIG. 3 is a front elevational view;
 FIG. 4 is a top plan view;
 FIG. 5 is a bottom plan view; and,
 FIG. 6 is a perspective view of the front and right side thereof.

1 Claim, 3 Drawing Sheets

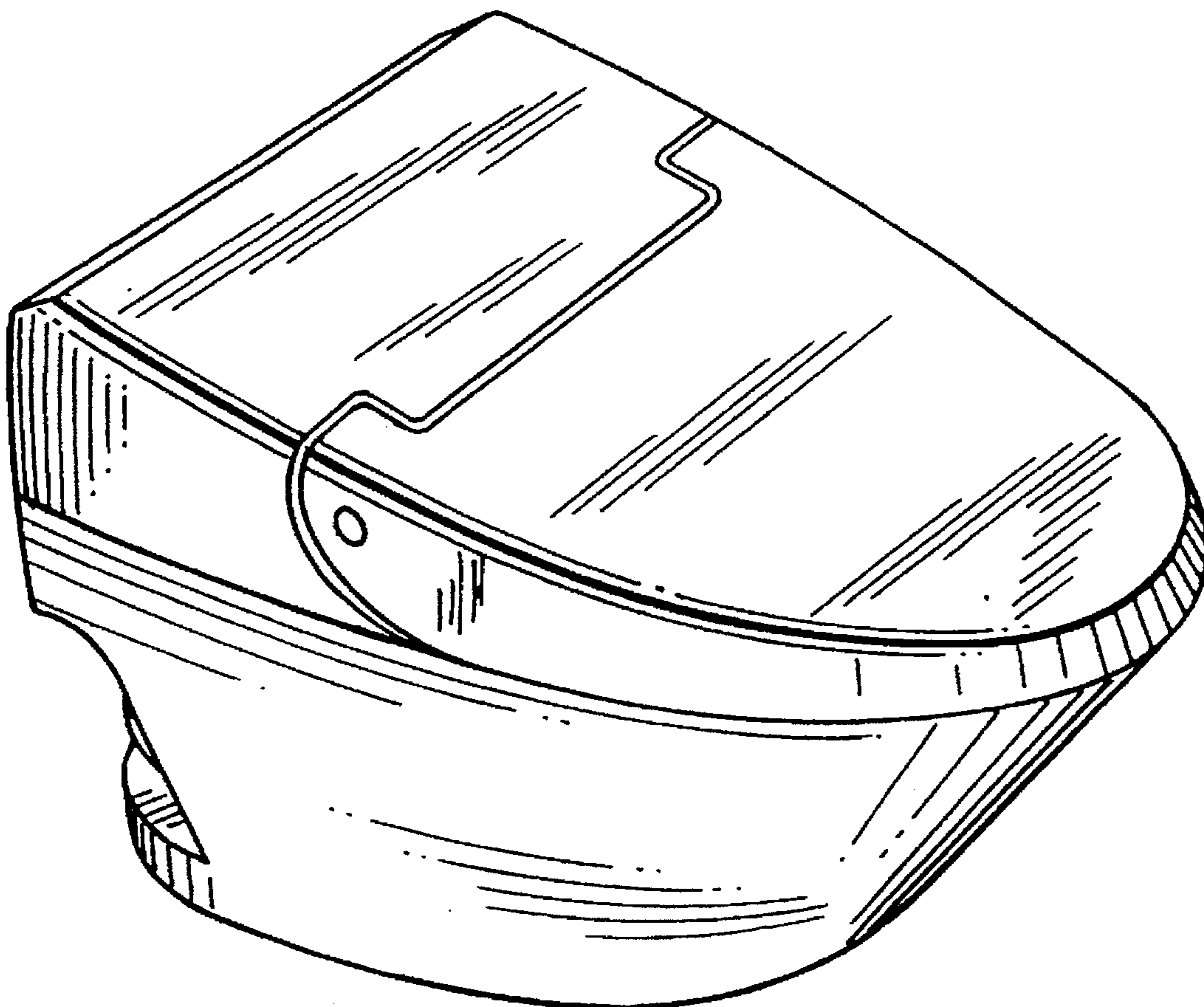

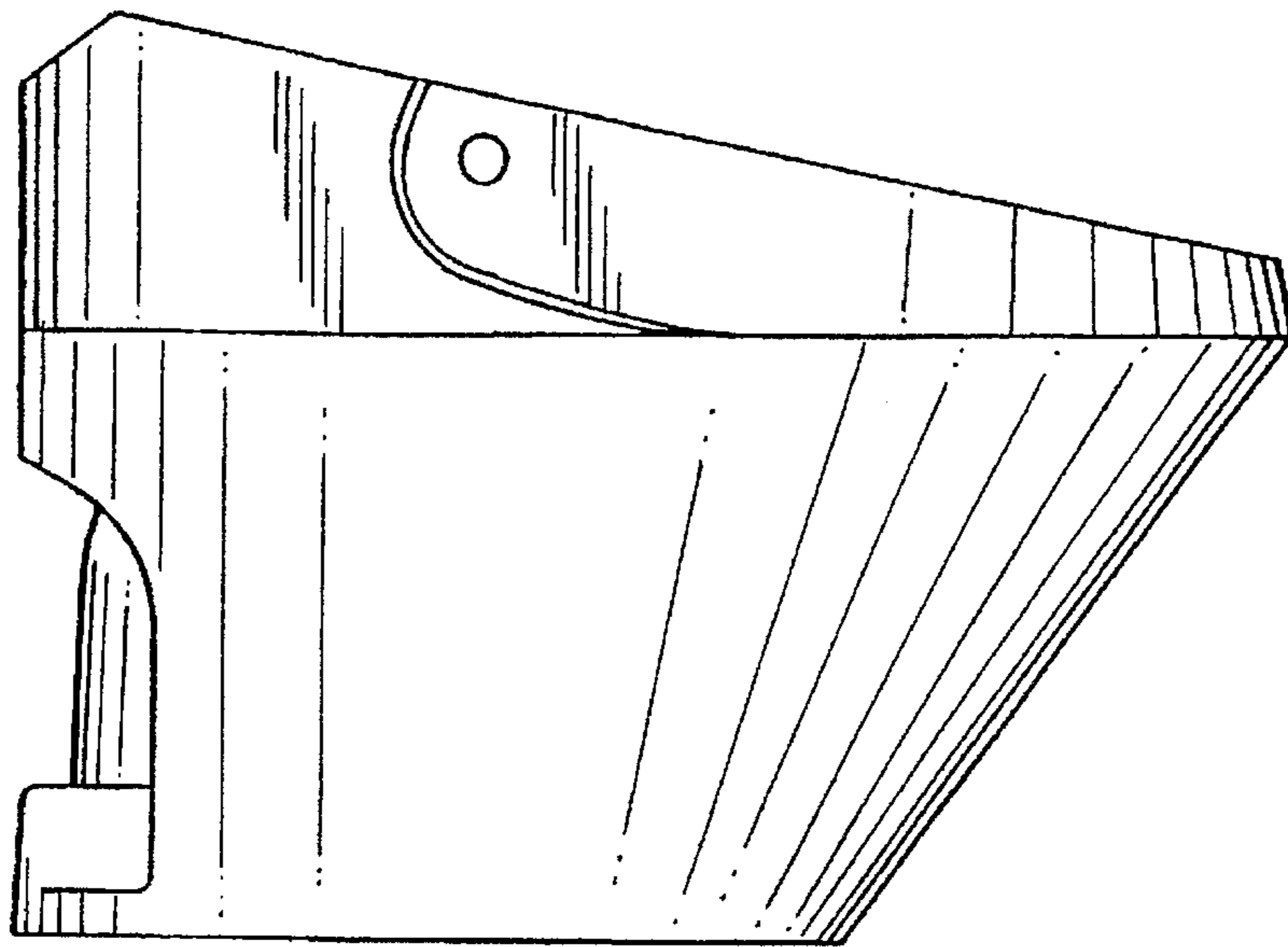

FIG. 1

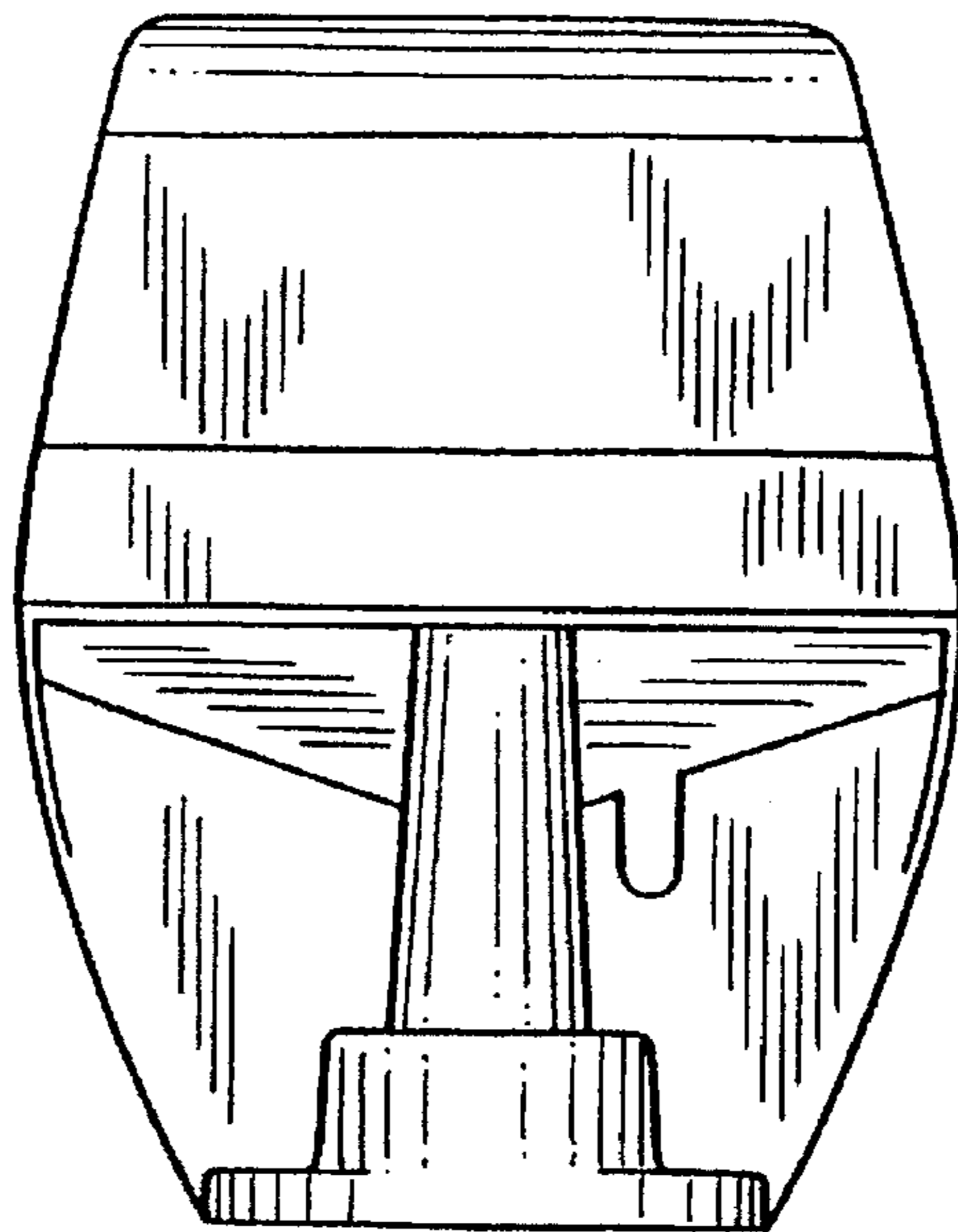

FIG. 2

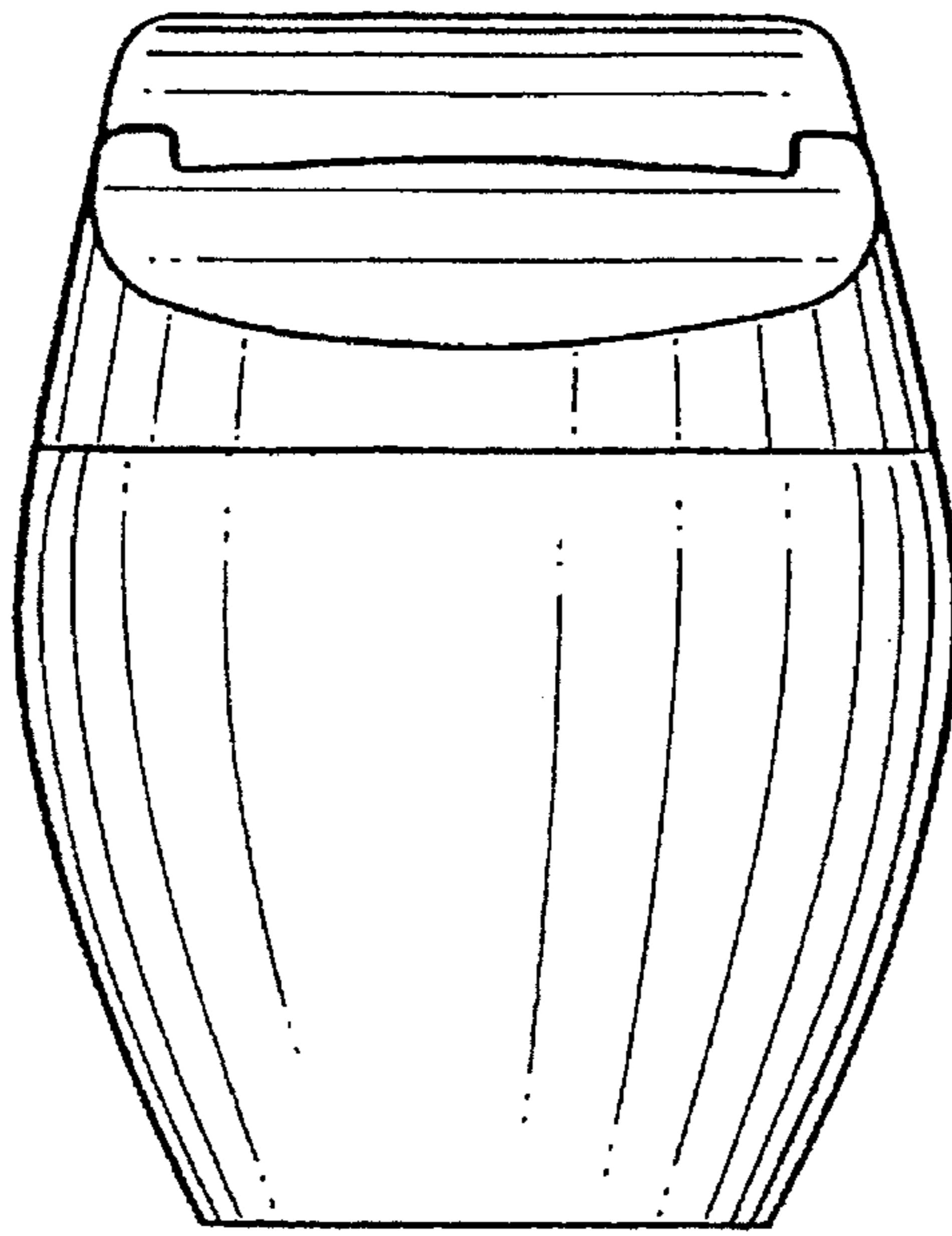

FIG. 3

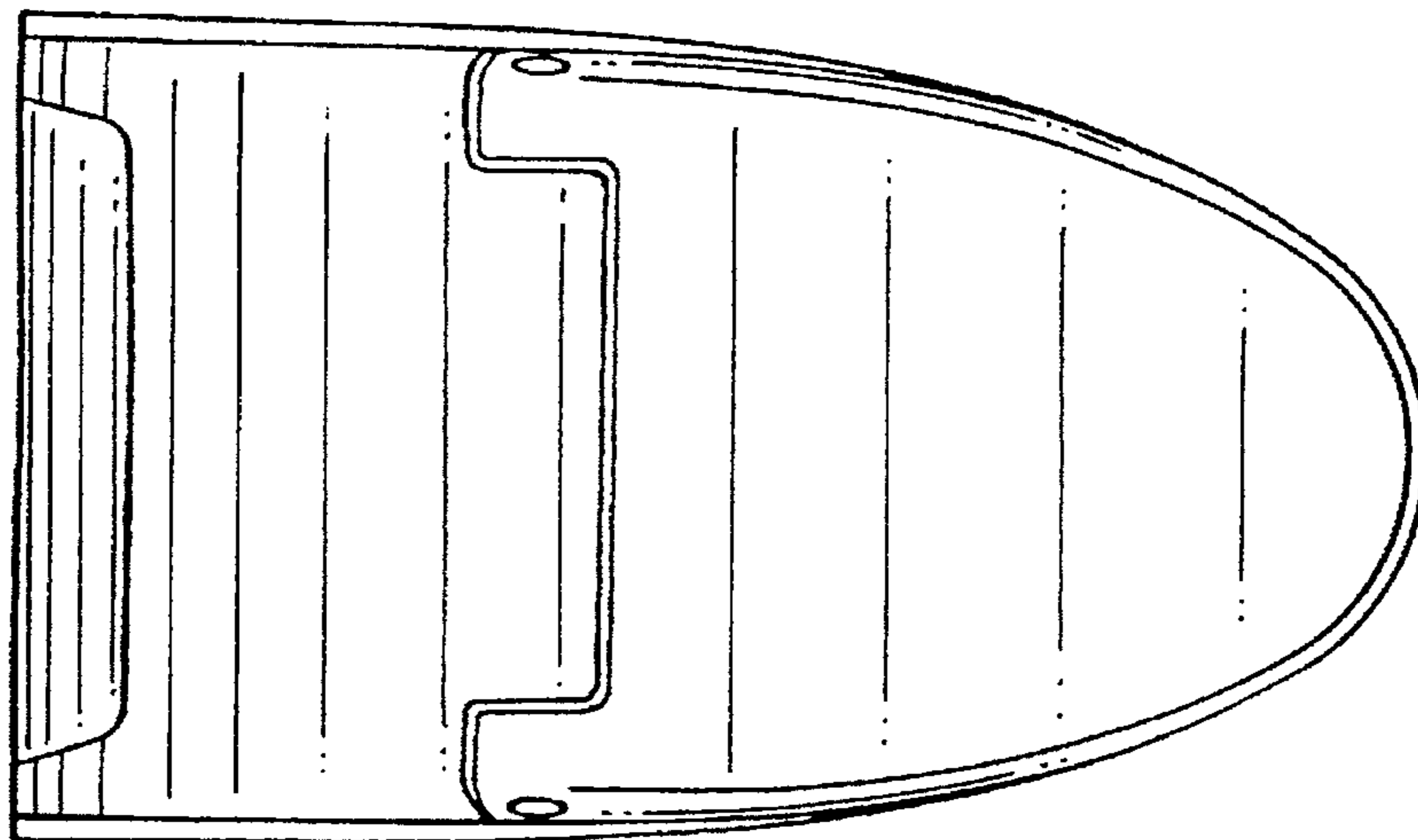

FIG. 4

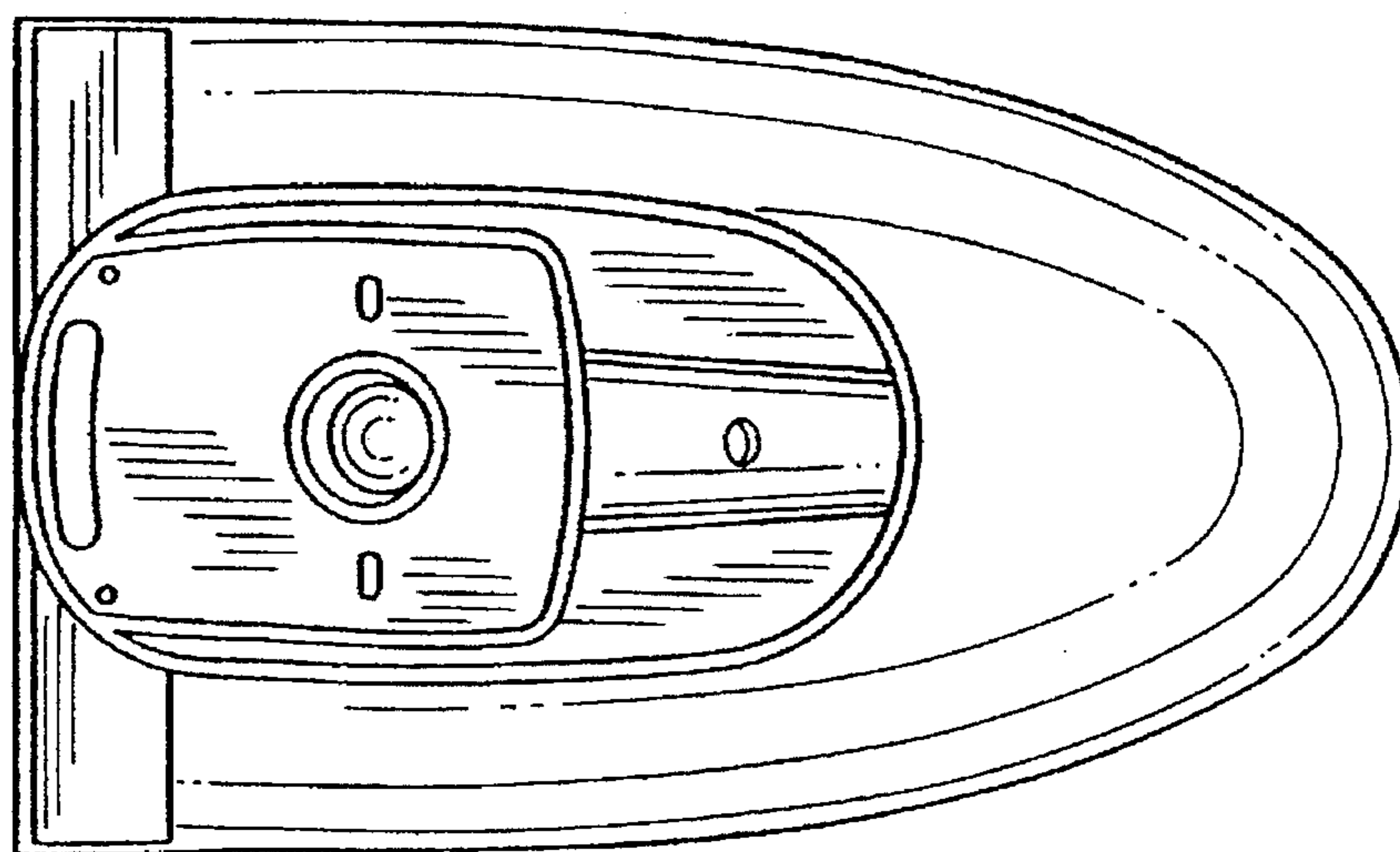

FIG. 5

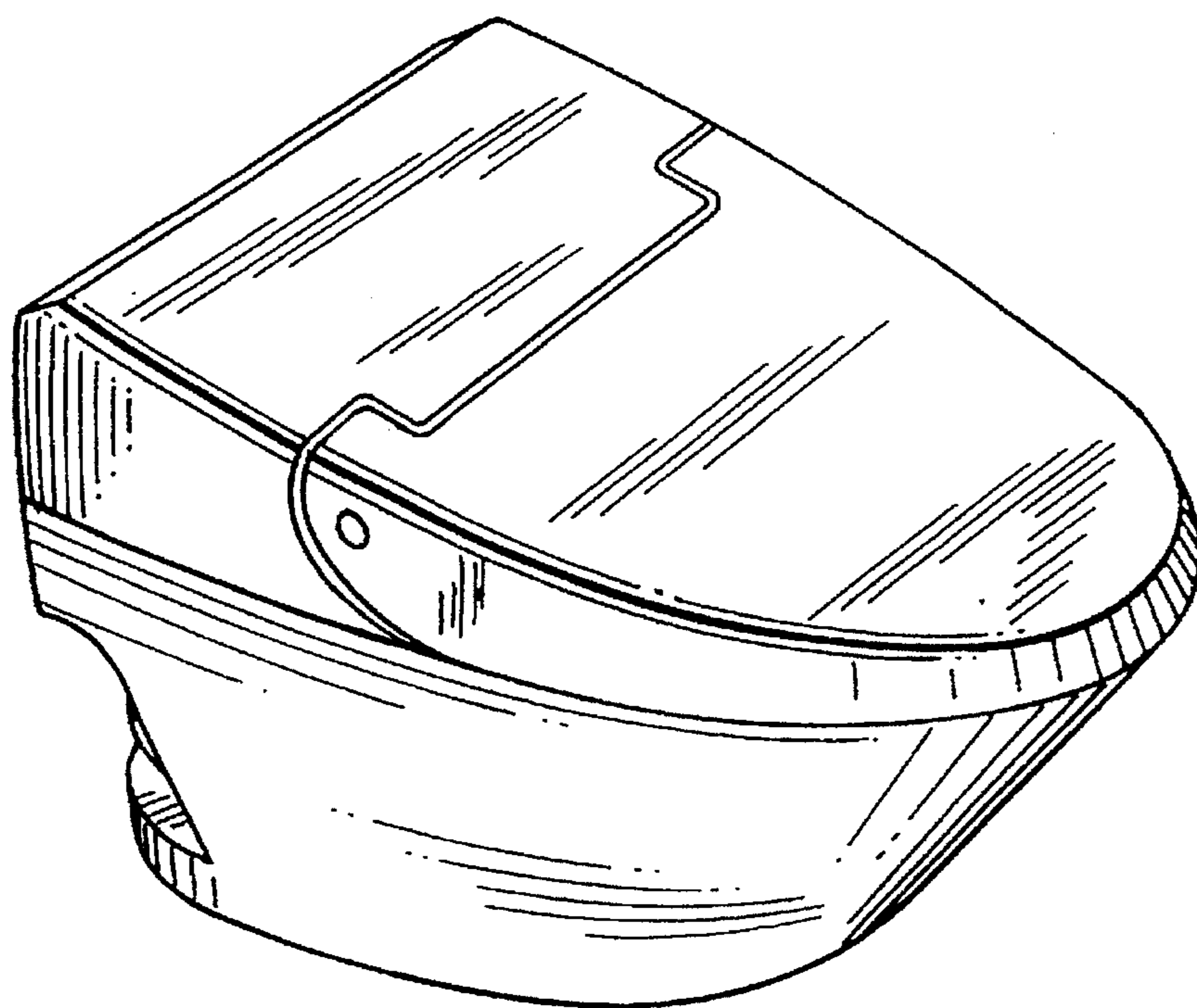

FIG. 6

UNITED STATES PATENT AND TRADEMARK OFFICE
CERTIFICATE OF CORRECTION

PATENT NO. : Des. 382,333
DATED : August 12, 1997
INVENTOR(S) : Seijiro KAWAMURA and Noriko Yoshi HASHIDA

It is certified that error appears in the above-identified patent and that said Letters Patent is hereby corrected as shown below:

Title page, please add after item [62] -- Item [30]

Foreign Application Priority Data:

Japanese Patent 5-39889 - filed 12/28/93; and
Japanese Patent 5-39890 - filed 12/28/93. --.

Signed and Sealed this
Twenty-fourth Day of February, 1998

Attest:



BRUCE LEHMAN

Attesting Officer

Commissioner of Patents and Trademarks