



US00D382311S

# United States Patent [19]

Turnidge

[11] Patent Number: Des. 382,311

[45] Date of Patent: \*\*Aug. 12, 1997

[54] GOLF BALL DISPENSER

[76] Inventor: Howard M. Turnidge, 2724 Elvyra Way #24, Sacramento, Calif. 95821

[\*\*] Term: 14 Years

[21] Appl. No.: 45,561

[22] Filed: Oct. 24, 1995

### Related U.S. Application Data

[63] Continuation-in-part of Ser. No. 23,256, May 20, 1994, abandoned.

[51] LOC (6) Cl. .... 21-02

[52] U.S. Cl. .... D21/234; D3/255

[58] Field of Search ..... D21/234, 208; D3/221, 224, 228, 254, 255; 473/132, 283; 206/315.1, 315.9; 224/918, 919, 163

### [56] References Cited

#### U.S. PATENT DOCUMENTS

- D. 251,338 3/1979 Evans et al. .... D3/221
- D. 282,303 1/1986 Jessen ..... D3/255 X
- D. 291,342 8/1987 Turnidge et al. .... D21/208
- D. 319,346 8/1991 Jessen ..... D3/255
- D. 321,032 10/1991 Marthaler et al. .... D21/234
- D. 339,227 9/1993 Fritze et al. .... D3/255

- 3,960,271 6/1976 Nelson ..... 206/315.1
- 4,784,305 11/1988 Schoenberg ..... 206/315.1 X
- 4,798,319 1/1989 James, Jr. .... 224/919 X
- 4,957,296 9/1990 Turnidge .
- 5,071,131 12/1991 Turnidge .

### OTHER PUBLICATIONS

"Golf Day", Summer 1991, p. 18, Deluxe Ball Shagger.

Primary Examiner—Sandra L. Morris

Attorney, Agent, or Firm—David Pressman

### [57] CLAIM

The ornamental design for a golf ball dispenser, as shown and described.

### DESCRIPTION

FIG. 1 is a perspective view of a golf ball dispenser showing my design;  
 FIG. 2 is a front elevation view thereof;  
 FIG. 3 is a left side elevation view thereof, the opposite side being a mirror image thereof;  
 FIG. 4 is a top plan view thereof;  
 FIG. 5 is a rear elevation view thereof; and  
 FIG. 6 is a bottom plan view thereof.  
 The broken lines in FIGS. 1, 3, and 5 indicate stitching.  
 The mesh in FIG. 4 is shown broken away for ease of illustration.

1 Claim, 6 Drawing Sheets

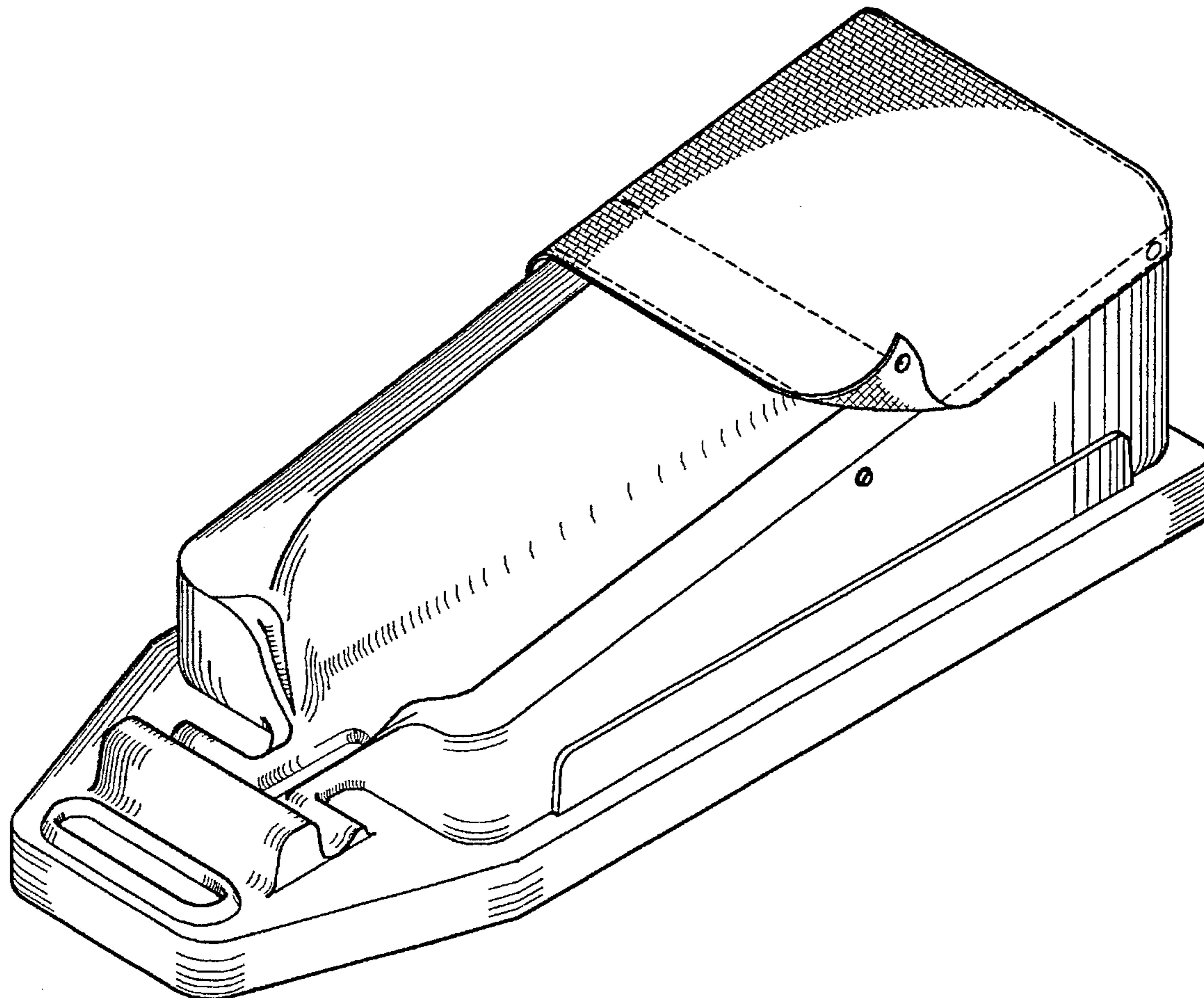

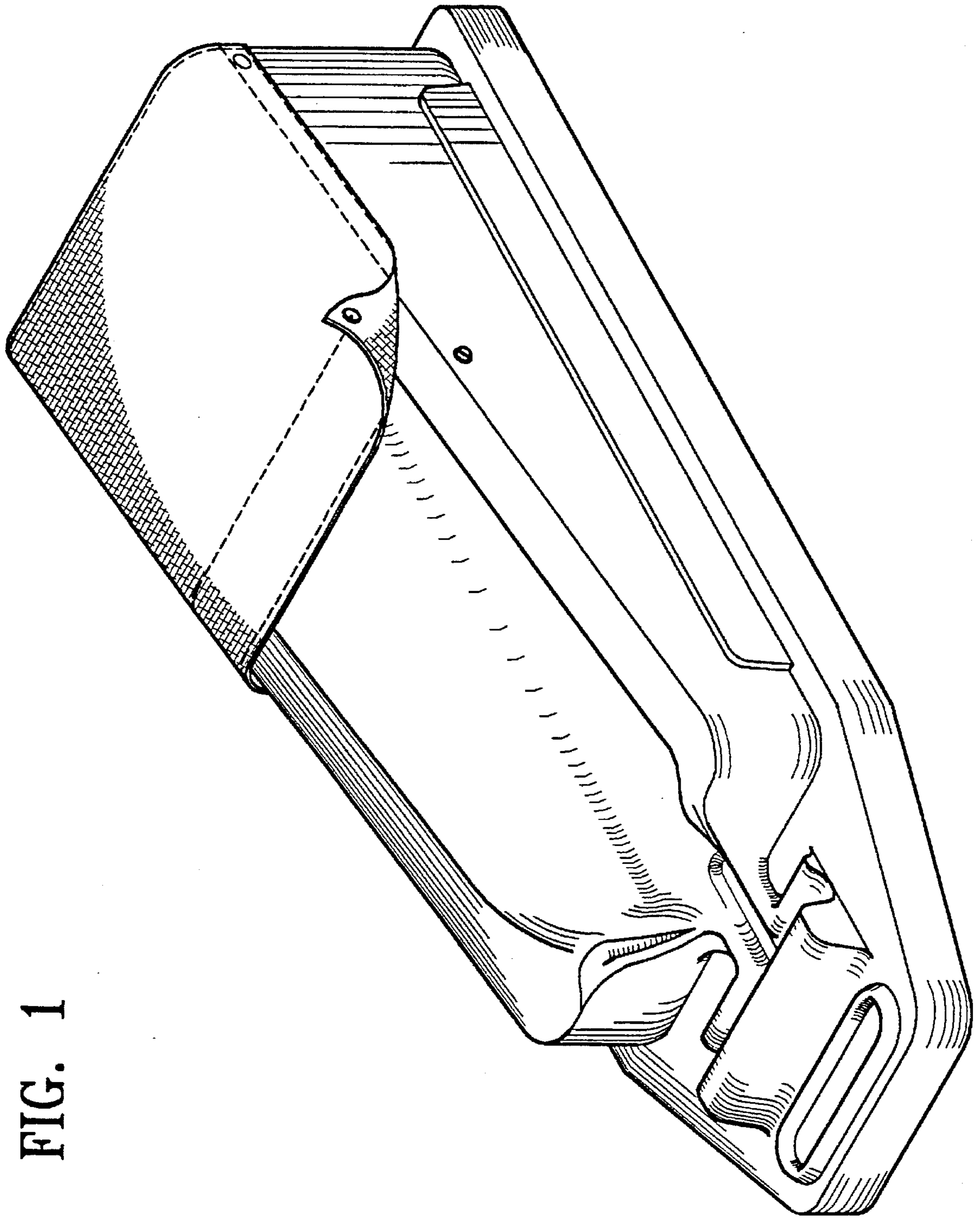
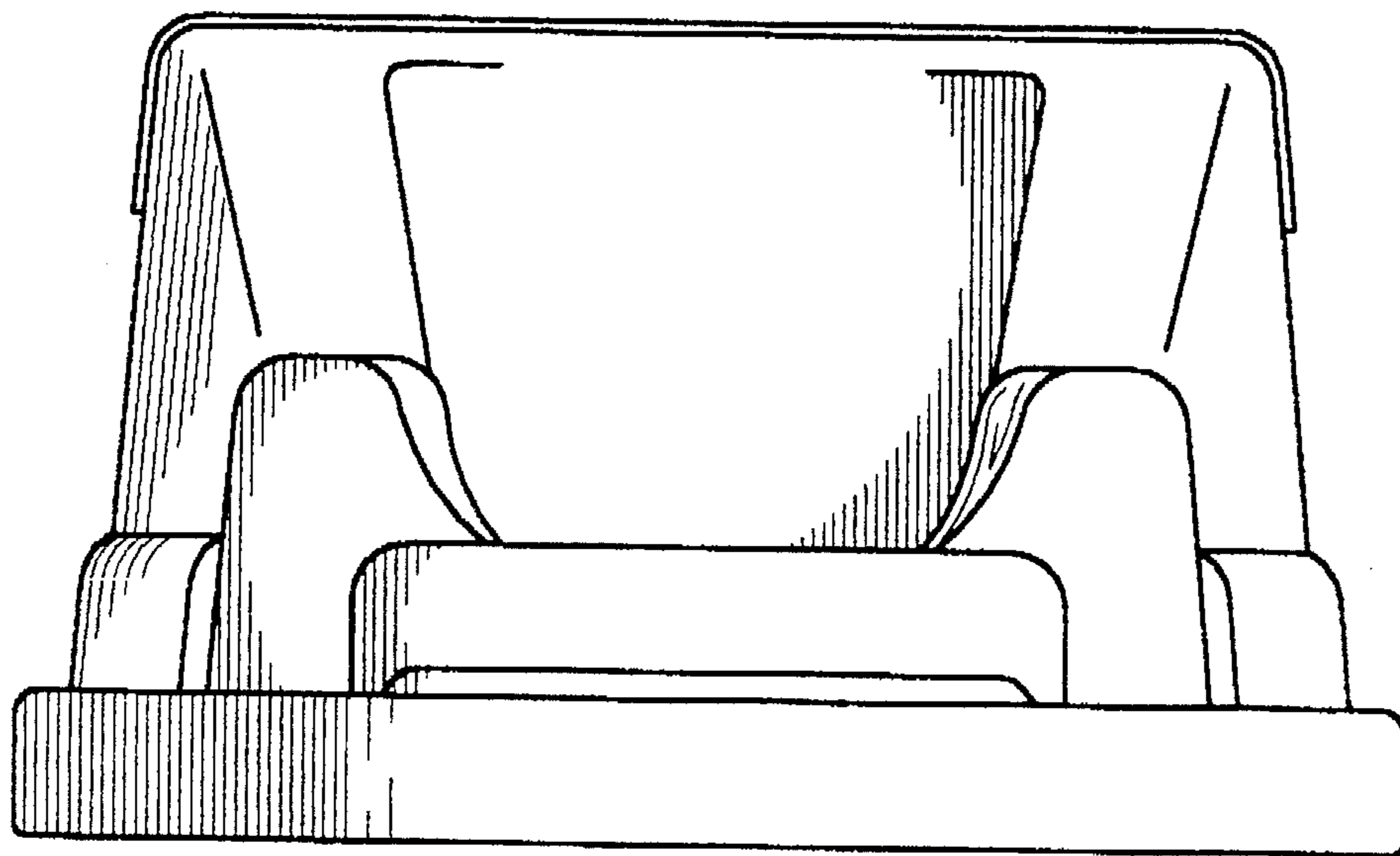
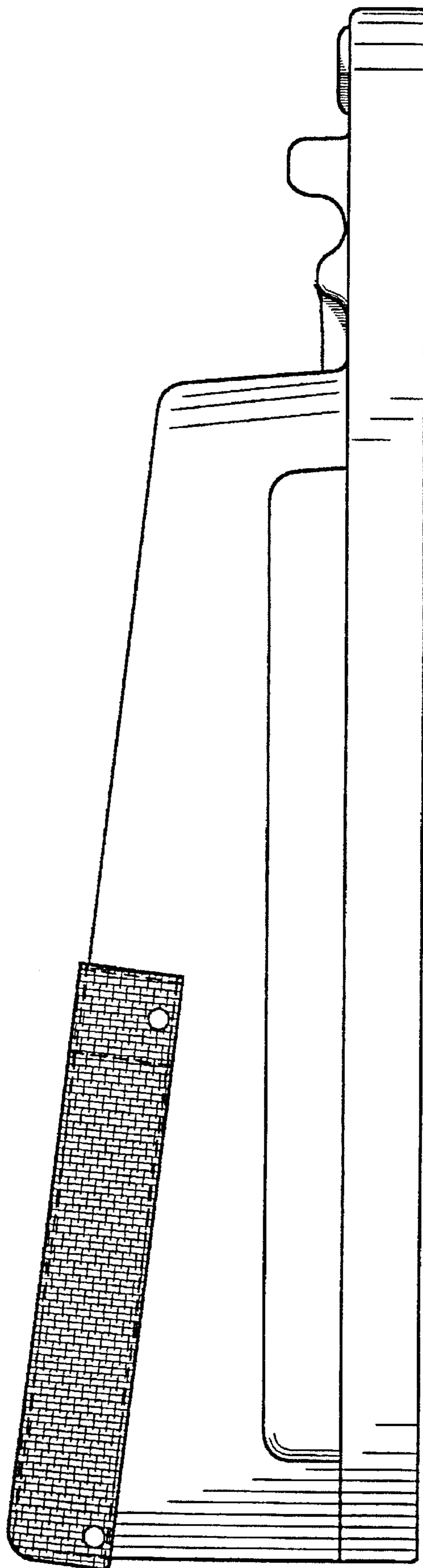

FIG. 1



*Figure 2*

FIG. 3



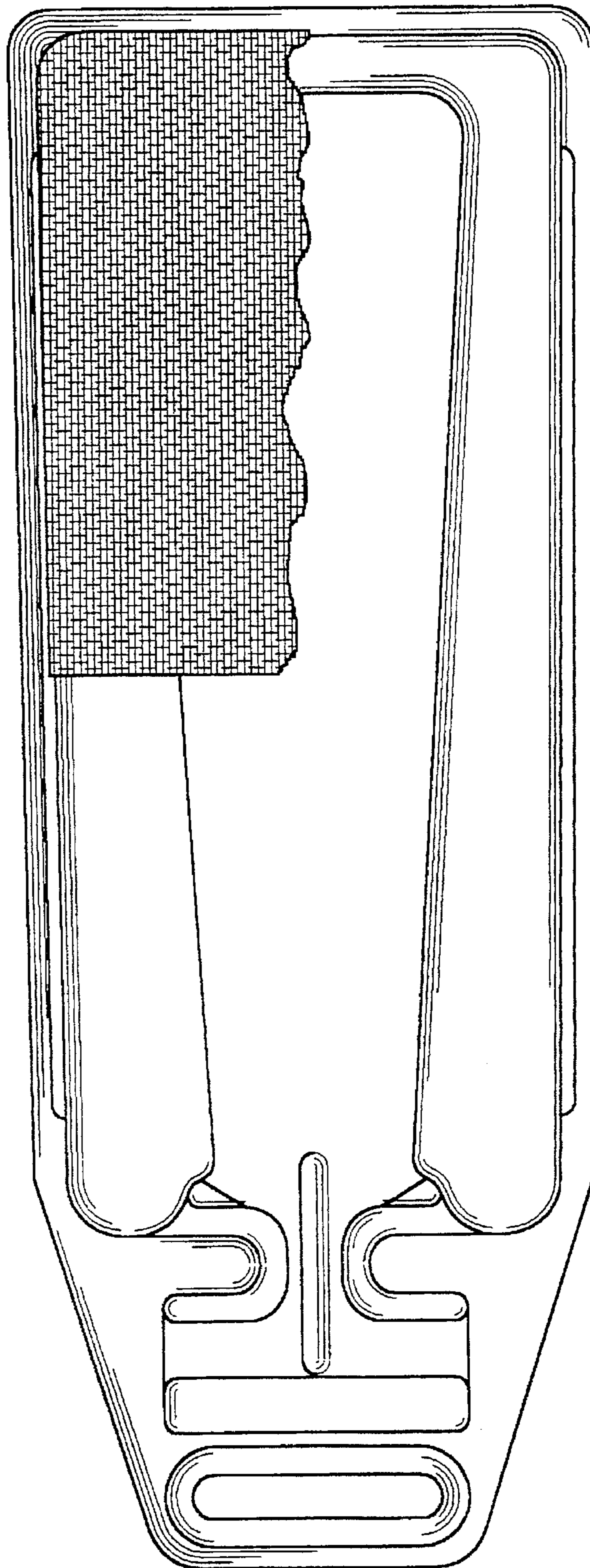
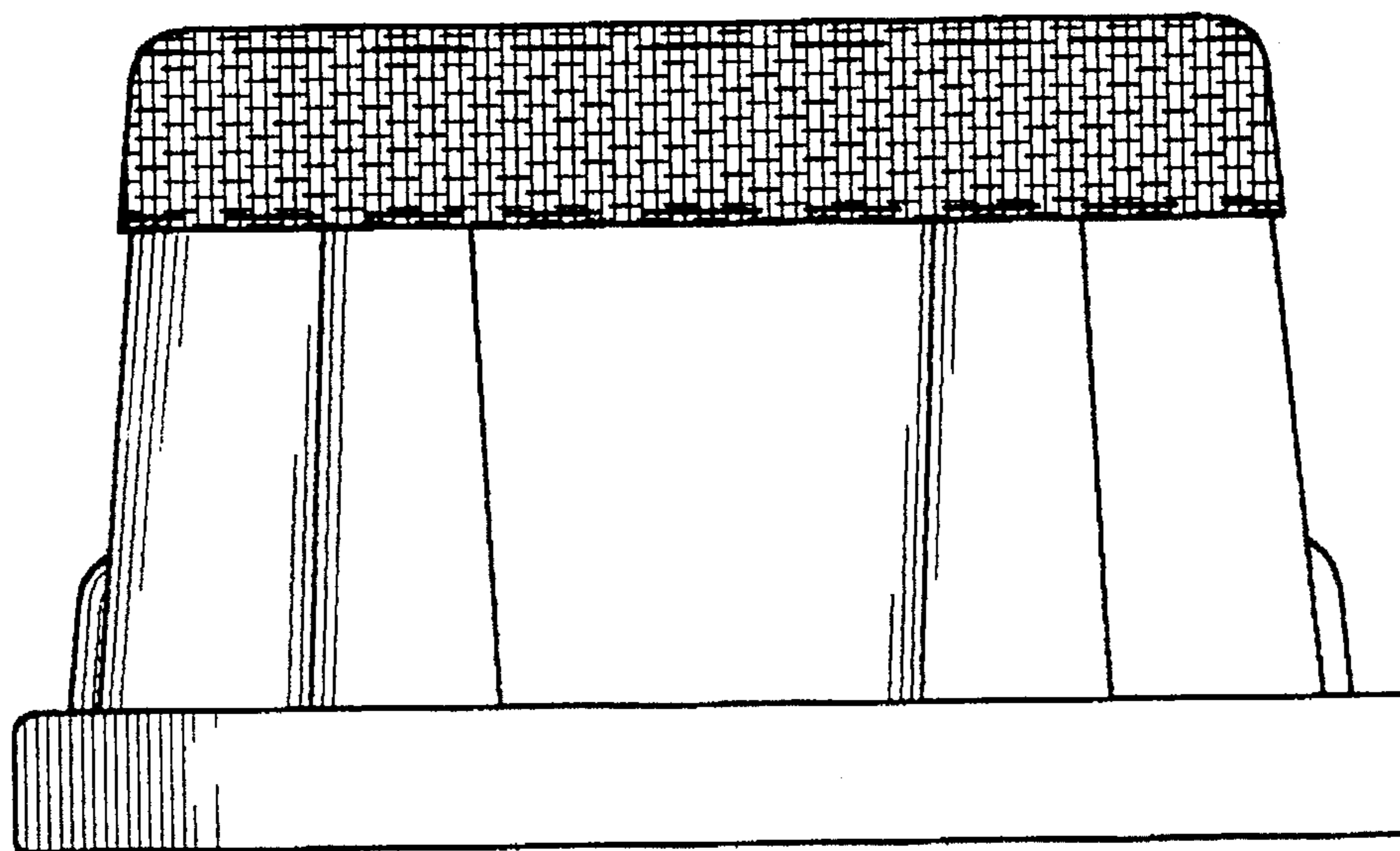

Figure 4



*Figure 5*

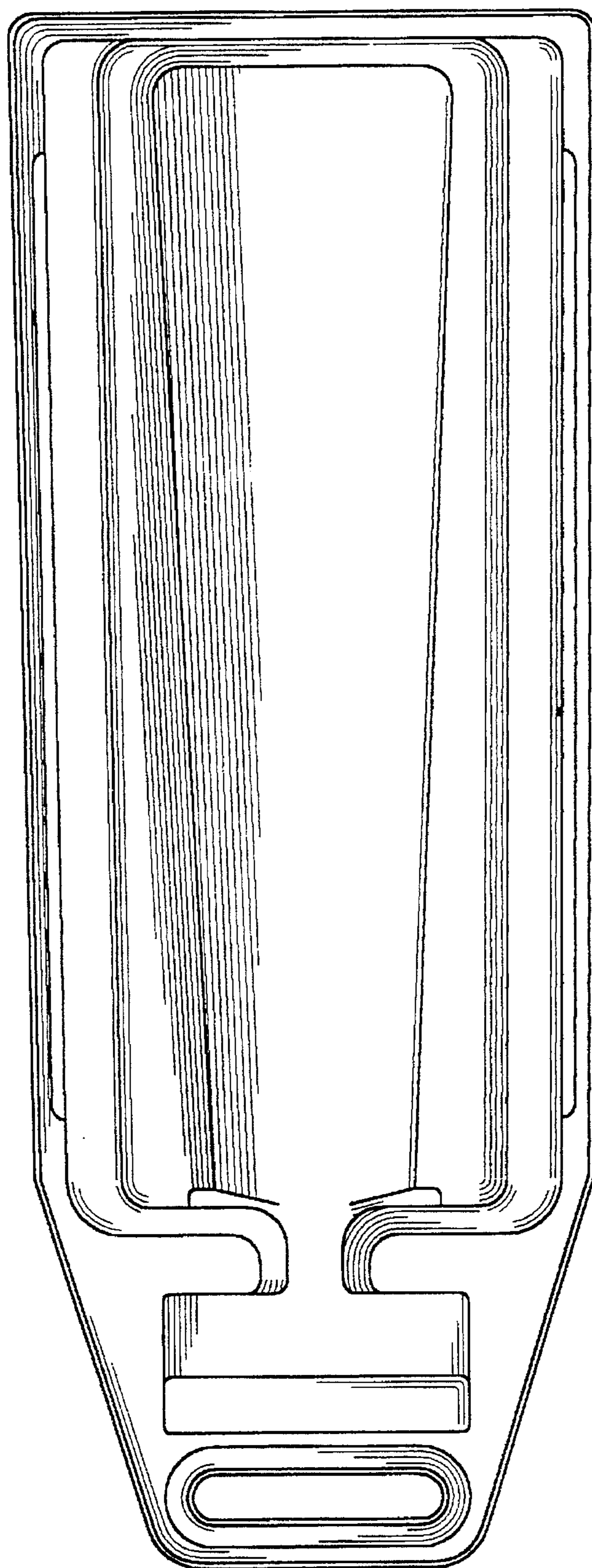

Figure 6