



US00D381936S

United States Patent [19]
Anscher

[11] **Patent Number:** **Des. 381,936**
[45] **Date of Patent:** ****Aug. 5, 1997**

[54] **SIDE-RELEASE BUCKLE**

[75] **Inventor:** **Joseph Anscher**, Muttontown, N.Y.

[73] **Assignee:** **National Molding Corp.**, Farmingdale, N.Y.

[**] **Term:** **14 Years**

[21] **Appl. No.:** **44,794**

[22] **Filed:** **Sep. 19, 1995**

[51] **LOC (6) Cl.** **02-07**

[52] **U.S. Cl.** **D11/216**

[58] **Field of Search** D8/383; 52/710,
52/699, 704-707; 24/200, 230 R, 196,
197, 193, 625, 575; D29/16; D11/200-218

[56] **References Cited**

U.S. PATENT DOCUMENTS

- D. 303,233 9/1989 Jang D11/216
- D. 310,448 9/1990 Scognamillo et al. D11/216
- D. 340,886 11/1993 Anscher D11/218

- D. 341,105 11/1993 Lovato D11/218
- D. 364,125 11/1995 Anscher D11/216
- 4,831,694 5/1989 Kong 24/625

Primary Examiner—Ralf Seifert
Attorney, Agent, or Firm—Kenyon & Kenyon

[57] **CLAIM**

The ornamental design for a side-release buckle, as shown and described.

DESCRIPTION

FIG. 1 is a top perspective view of a buckle showing my new design;
FIG. 2 is a front-side view thereof;
FIG. 3 is a rear-side view thereof;
FIG. 4 is a lateral-side view thereof;
FIG. 5 is a top plan view thereof;
FIG. 6 is a bottom plan view thereof;
FIG. 7 is a top exploded view thereof;
FIG. 8 is a bottom exploded view thereof; and,
FIG. 9 is a bottom perspective view thereof.

1 Claim, 5 Drawing Sheets

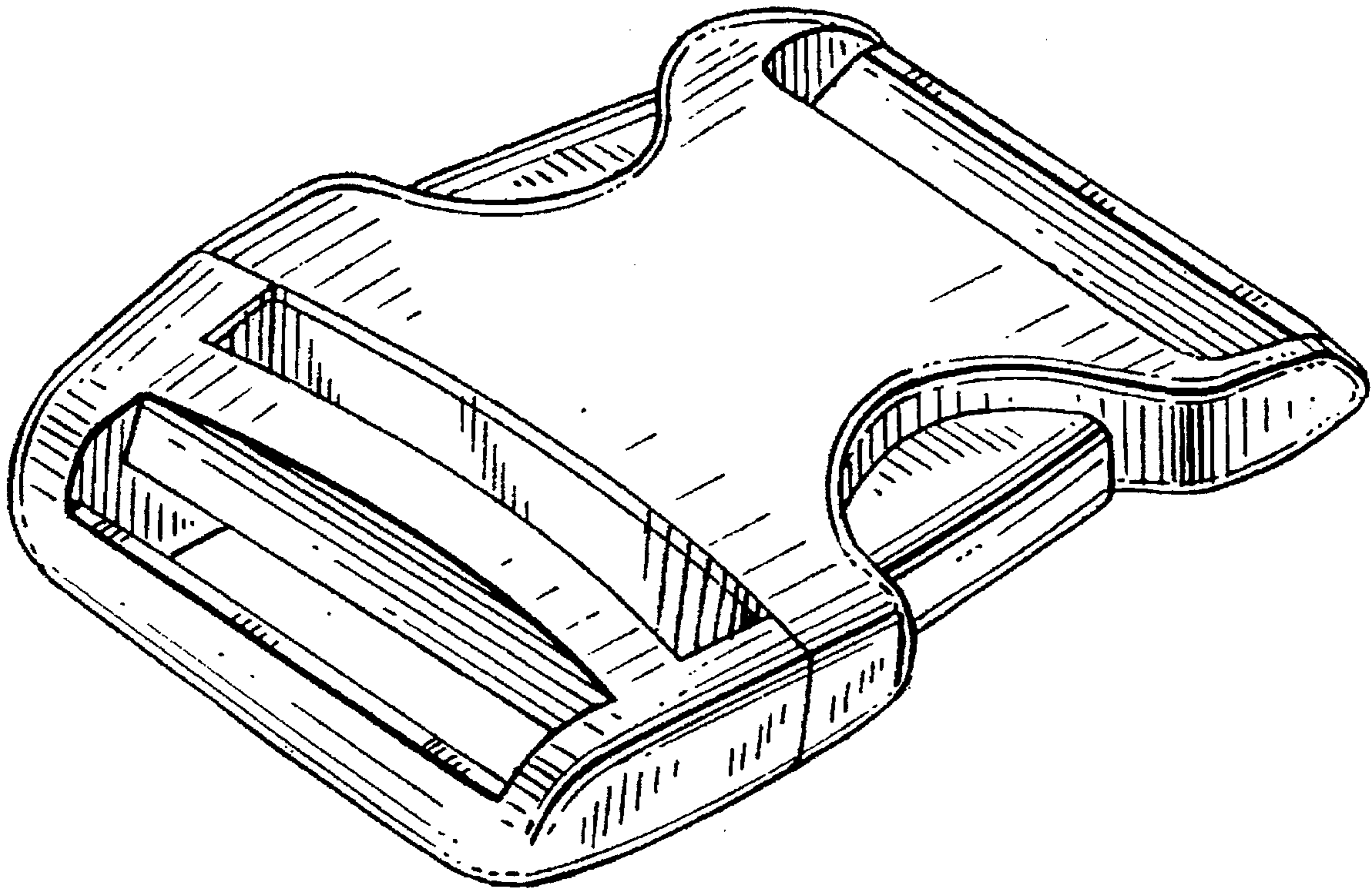

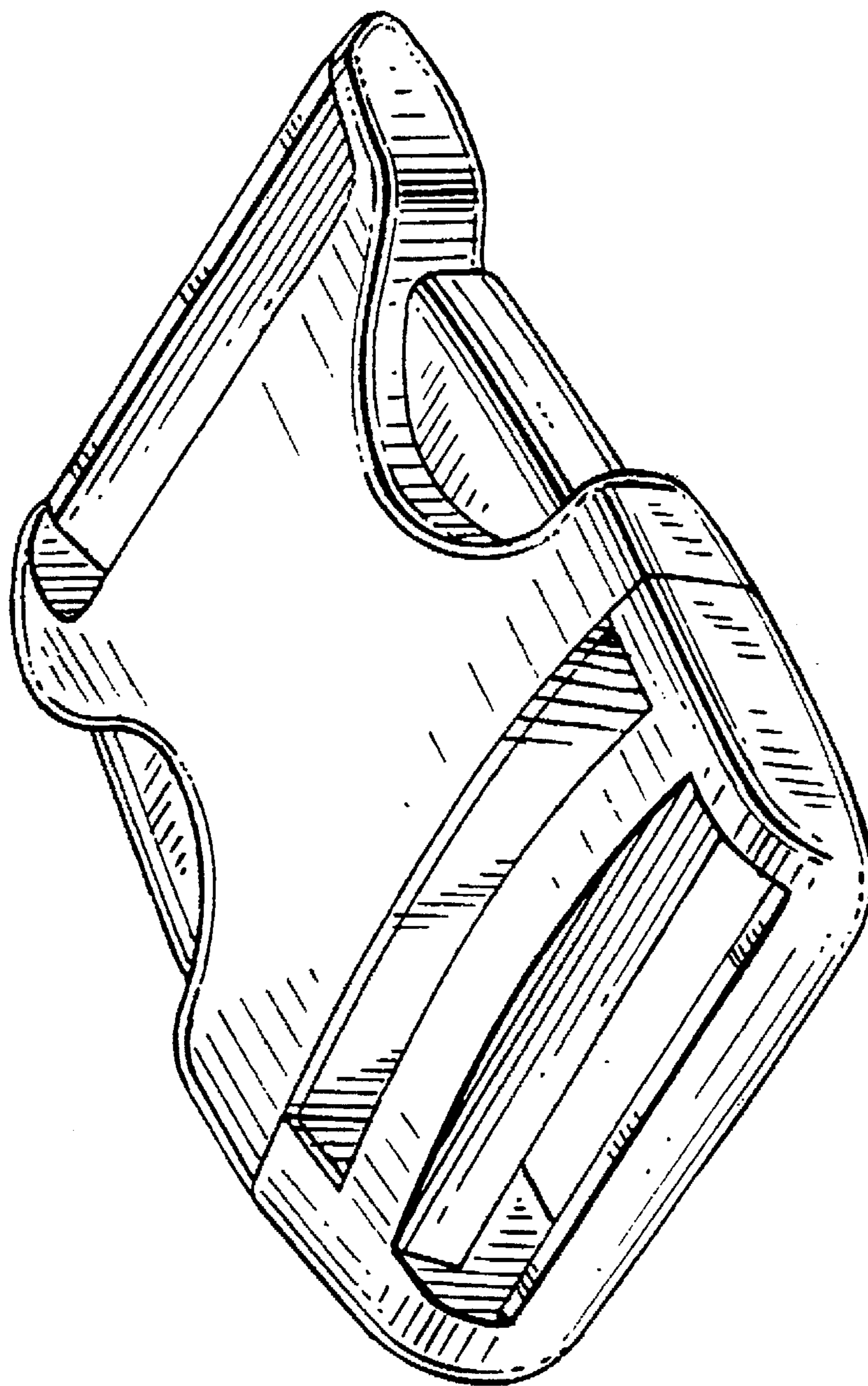

FIG. 1

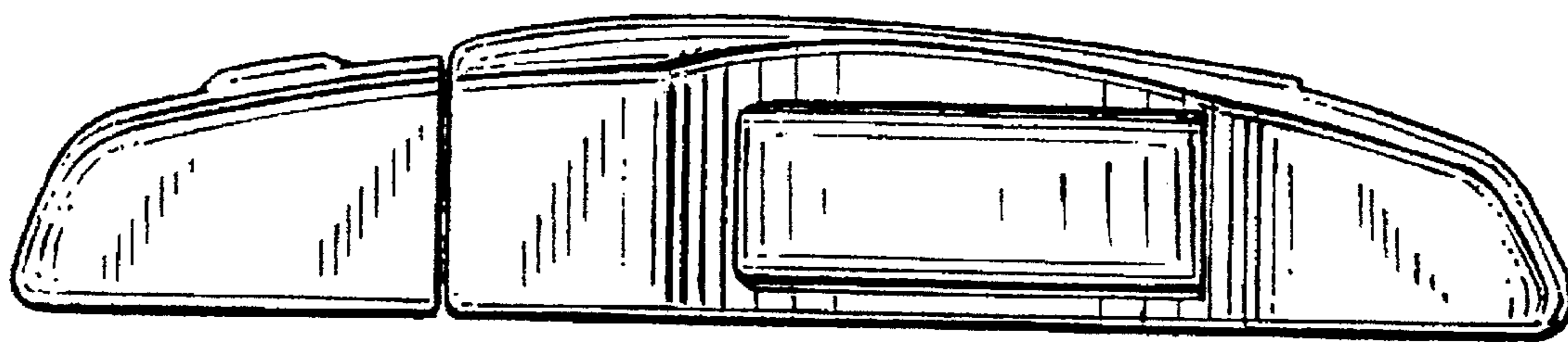

FIG. 4

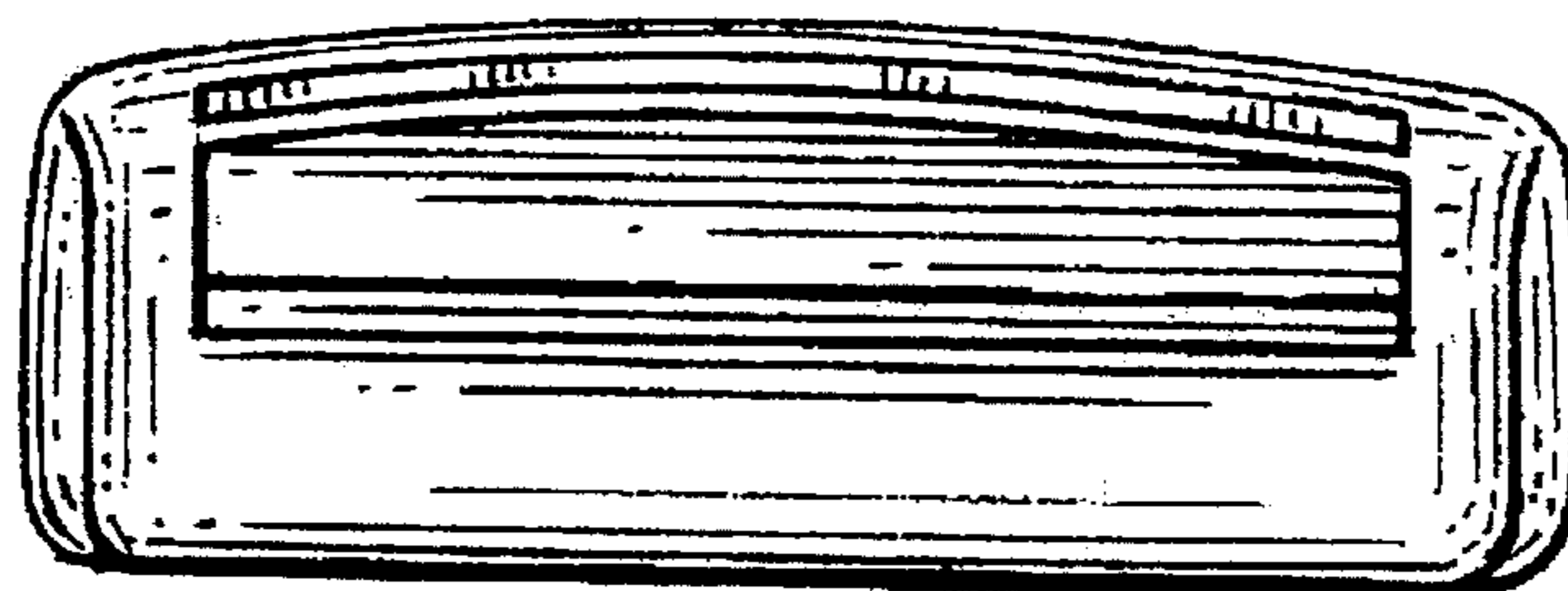

FIG. 2

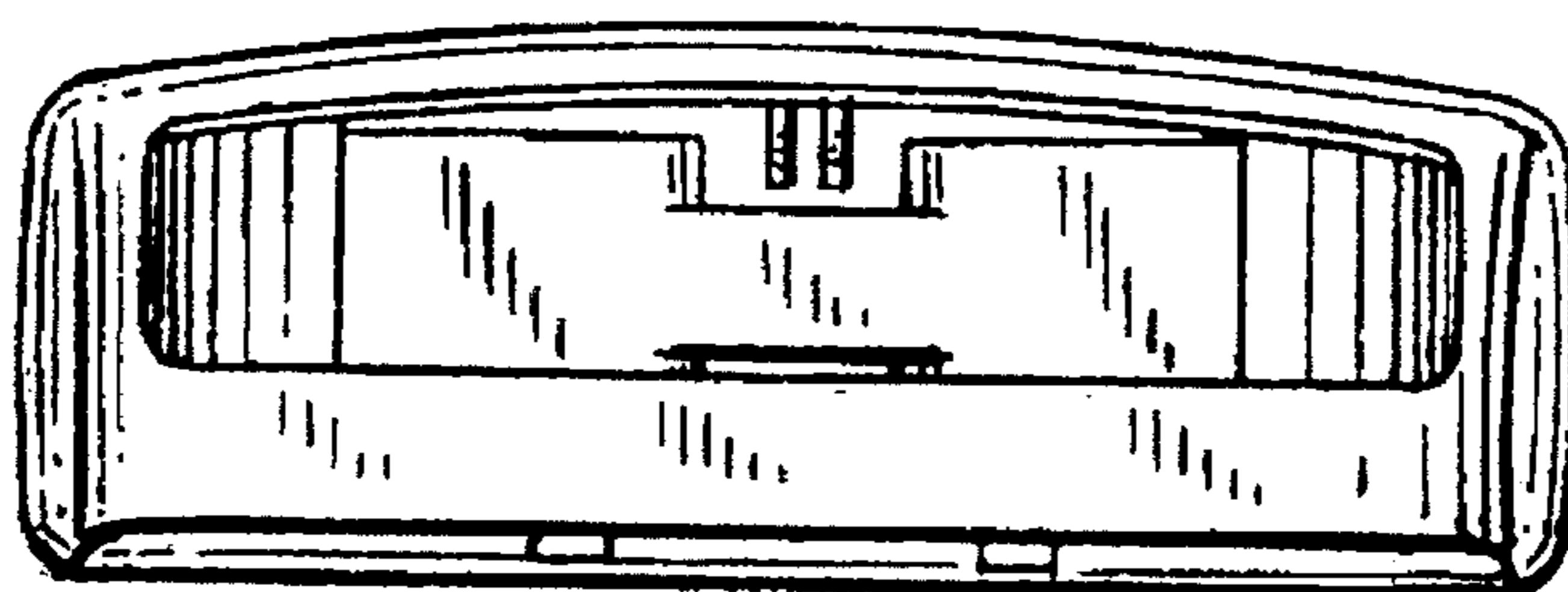

FIG. 3

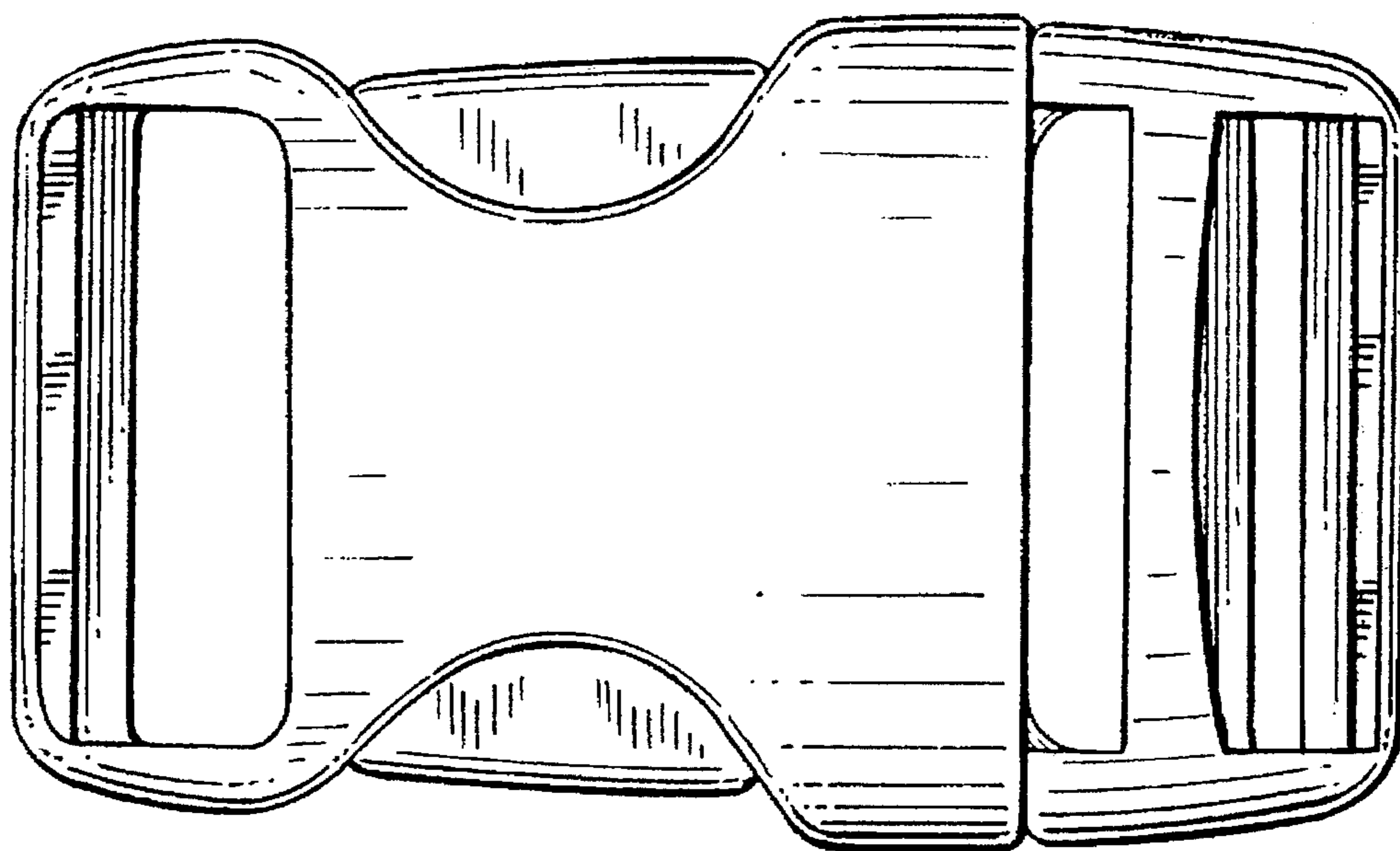

FIG. 5

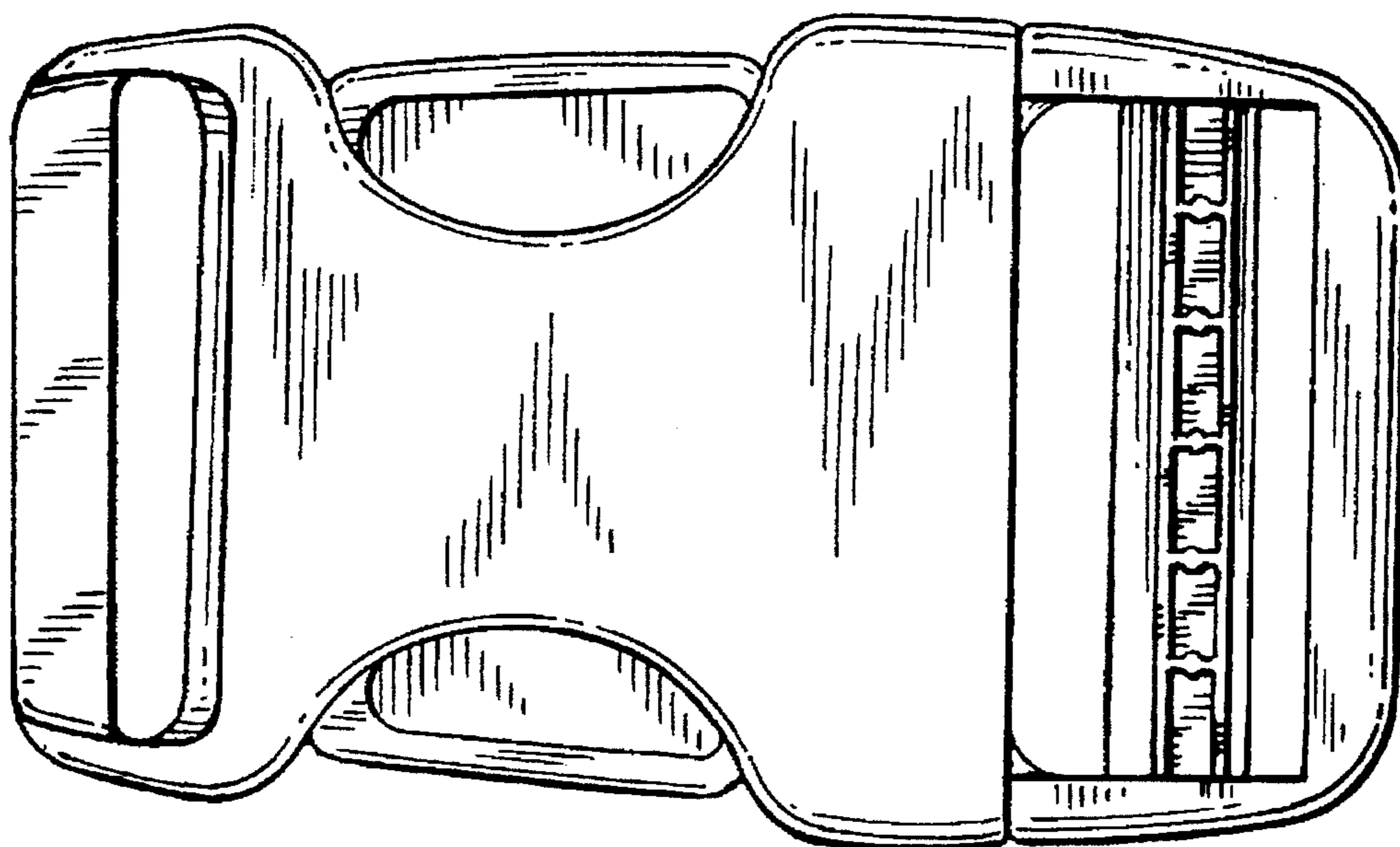

FIG. 6

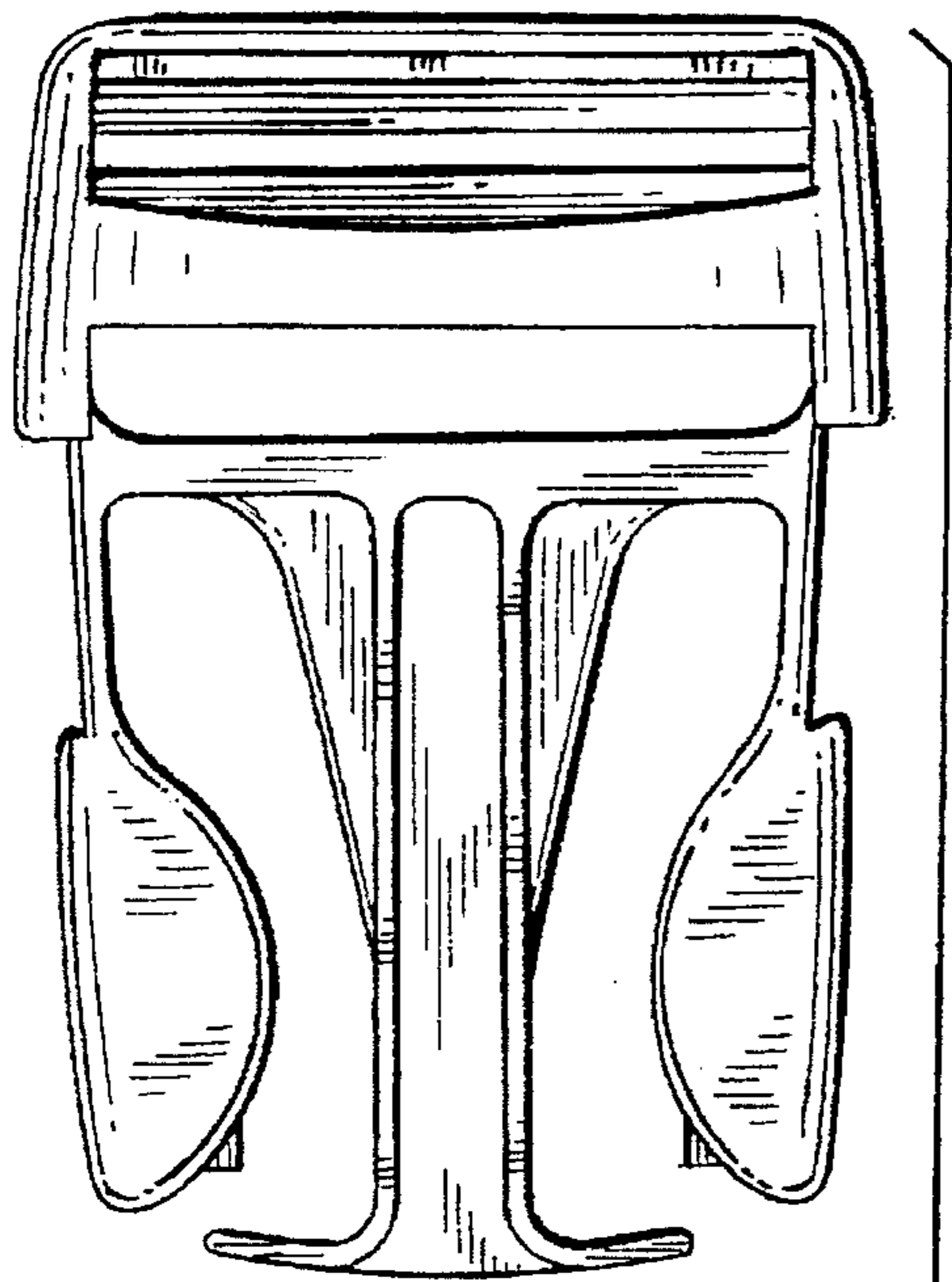

FIG. 7

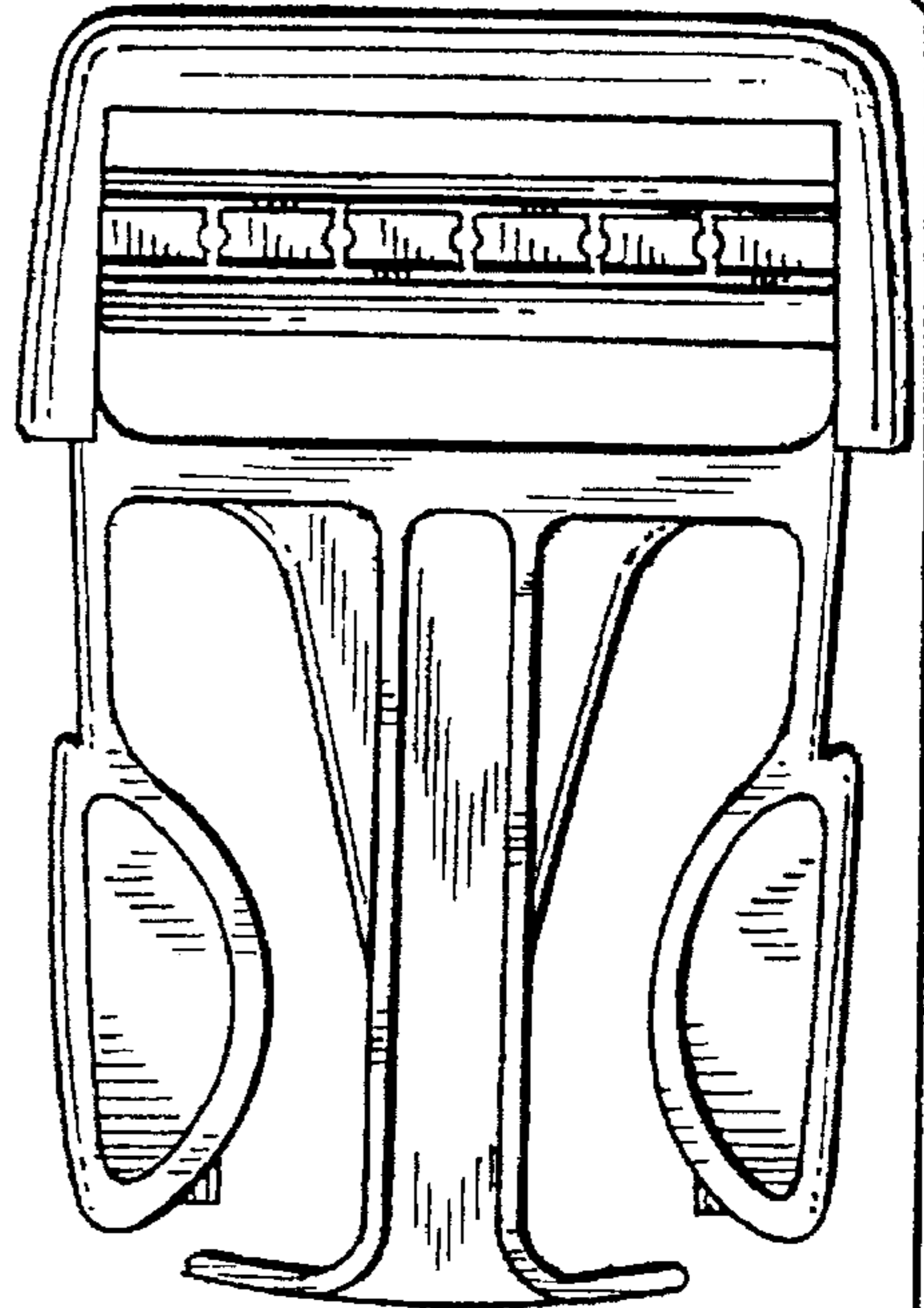

FIG. 8

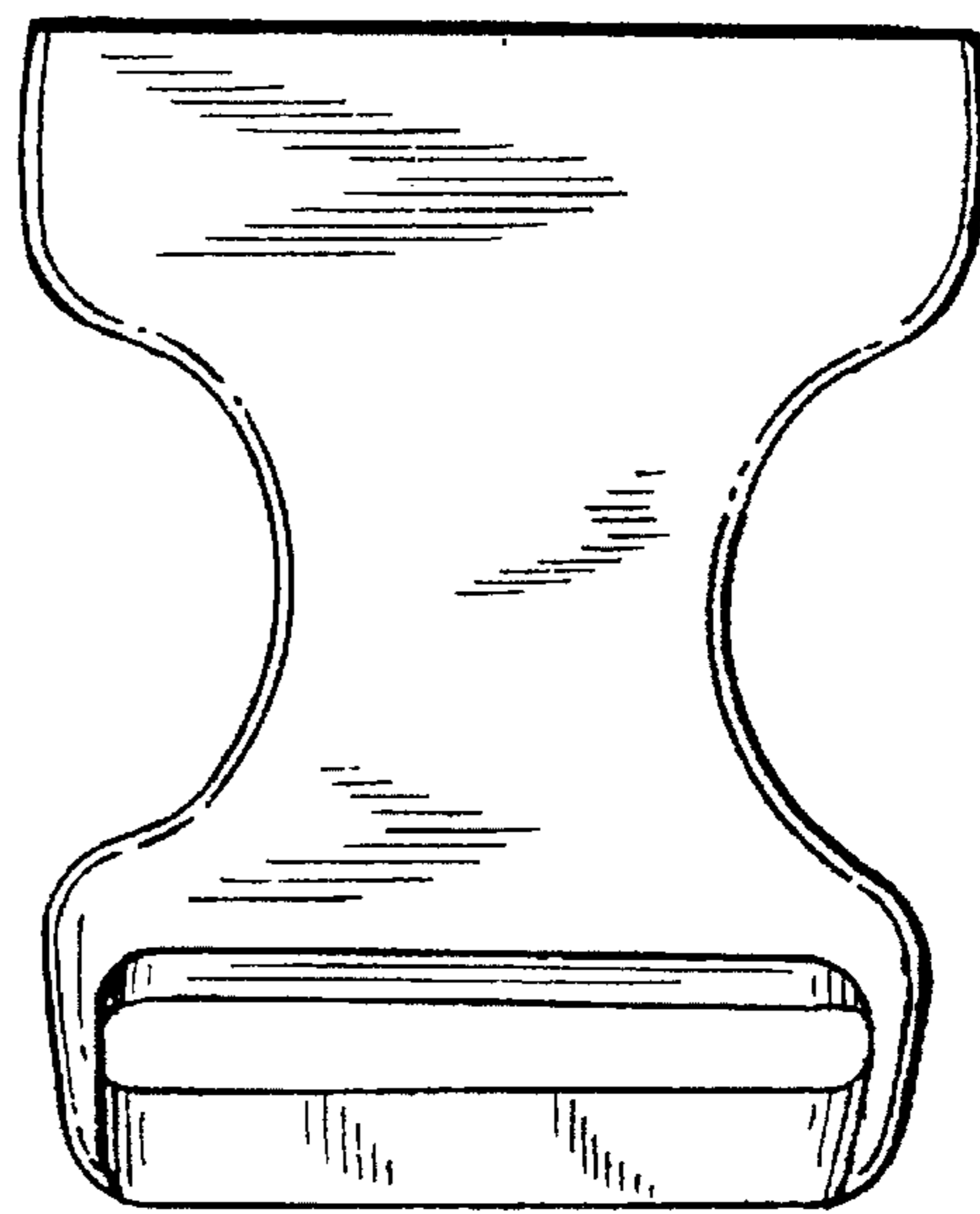
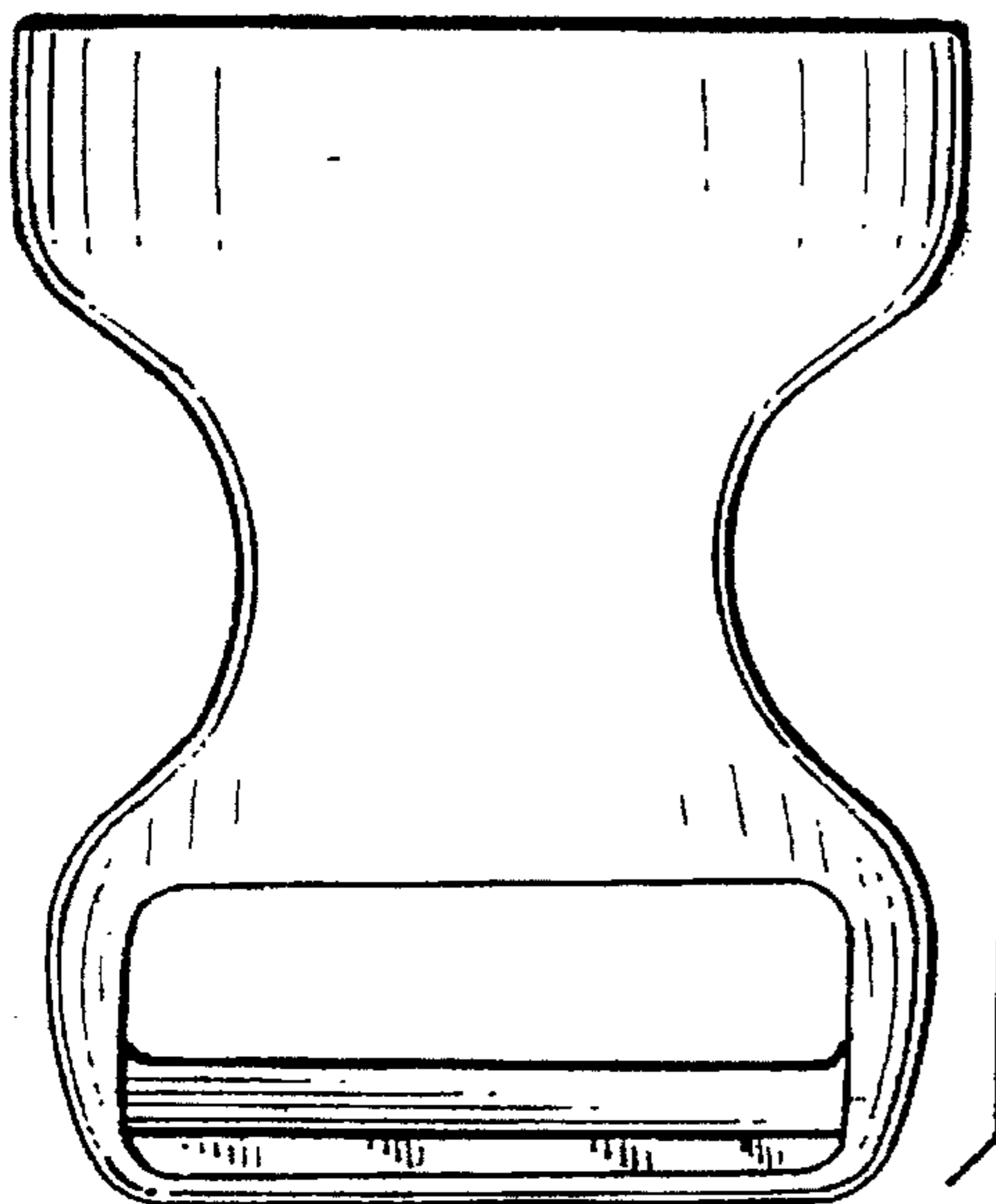

FIG. 9

