



US00D381867S

# United States Patent [19]

Jeppesen et al.

[11] Patent Number: **Des. 381,867**

[45] Date of Patent: **\*\*Aug. 5, 1997**

[54] **SEAL FOR CONDIMENT SHAKER**

4,747,518 5/1988 Laauwe .

[75] Inventors: **Hanne Dalsgaard Jeppesen**, Holte;  
**Jakob Heiberg**, Charlottenlund; **Stig Lillelund**, Gentofte, all of Denmark

*Primary Examiner*—Terry A. Wallace  
*Attorney, Agent, or Firm*—John A. Doninger

[73] Assignee: **Dart Industries Inc.**, Orlando, Fla.

[\*\*] Term: **14 Years**

[57] **CLAIM**

The ornamental design for a seal for condiment shaker, as shown and described.

[21] Appl. No.: **49,657**

**DESCRIPTION**

[22] Filed: **Feb. 15, 1996**

FIG. 1 is a top, front and side perspective view of a seal for condiment shaker showing our new design;

[51] **LOC (6) Cl.** ..... **07-06**

FIG. 2 is a top, front and side perspective view thereof with the seal open;

[52] **U.S. Cl.** ..... **D7/401.1; D7/591**

FIG. 3 is a top plan view thereof;

[58] **Field of Search** ..... **D7/590-597, 401.1; D9/509-514, 434, 435, 447; 222/142.1-142.9**

FIG. 4 is a bottom plan view thereof;

FIG. 5 is a front elevation view thereof;

FIG. 6 is a rear elevation view thereof;

FIG. 7 is a left side elevation view thereof;

FIG. 8 is a right side elevation view thereof;

FIG. 9 is a cross-section thereof taken on line 9—9 in FIG.3; and,

FIG. 10 is a cross-section thereof taken on line 10—10 in FIG. 3.

[56] **References Cited**

**U.S. PATENT DOCUMENTS**

- D. 318,778 8/1991 Fiore et al. .
- 2,937,793 5/1960 Cornelius ..... D7/597 X
- 3,782,575 1/1974 Braun .
- 3,934,745 1/1976 Lovell .
- 4,180,178 12/1979 Turner .

**1 Claim, 3 Drawing Sheets**

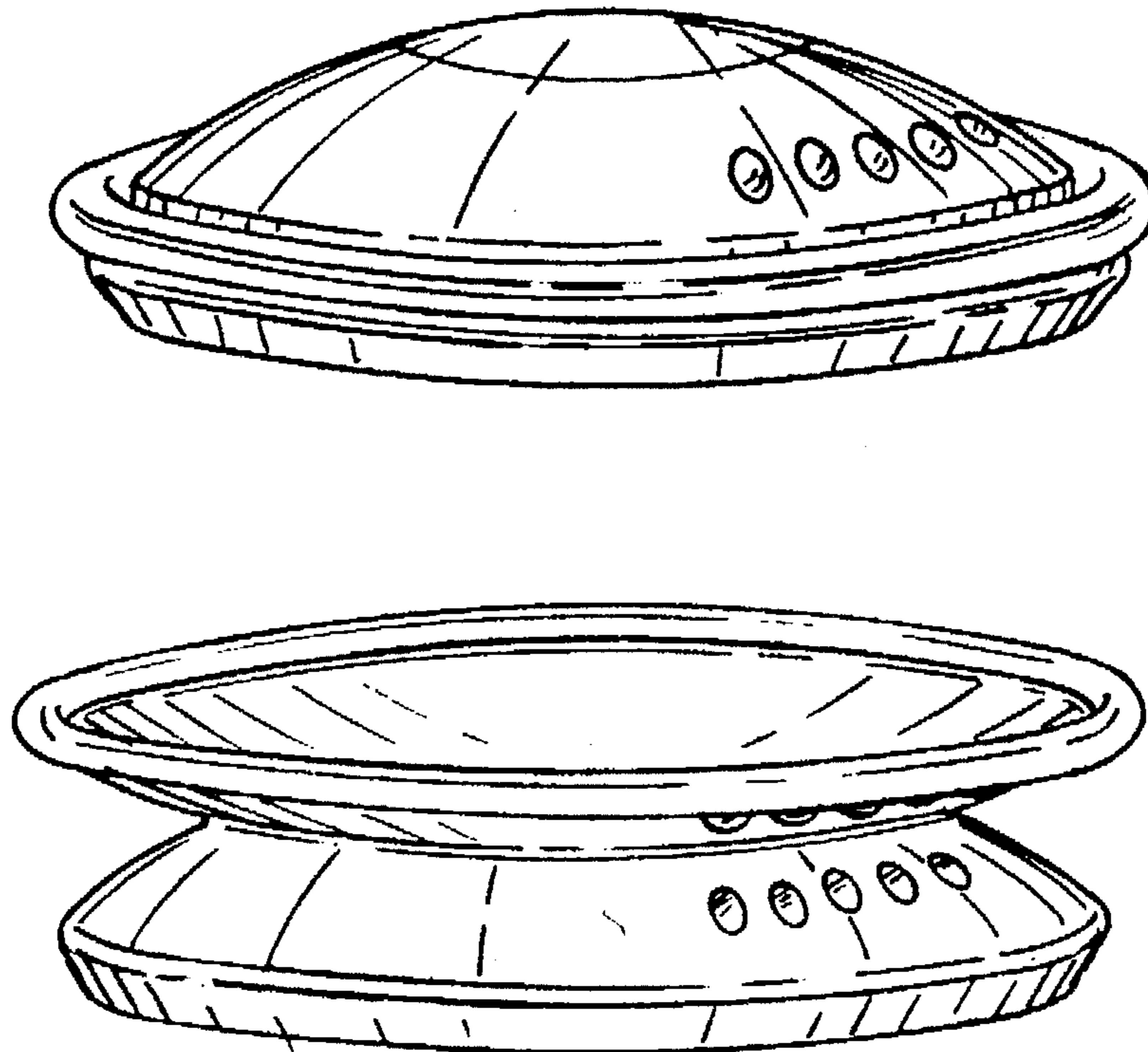

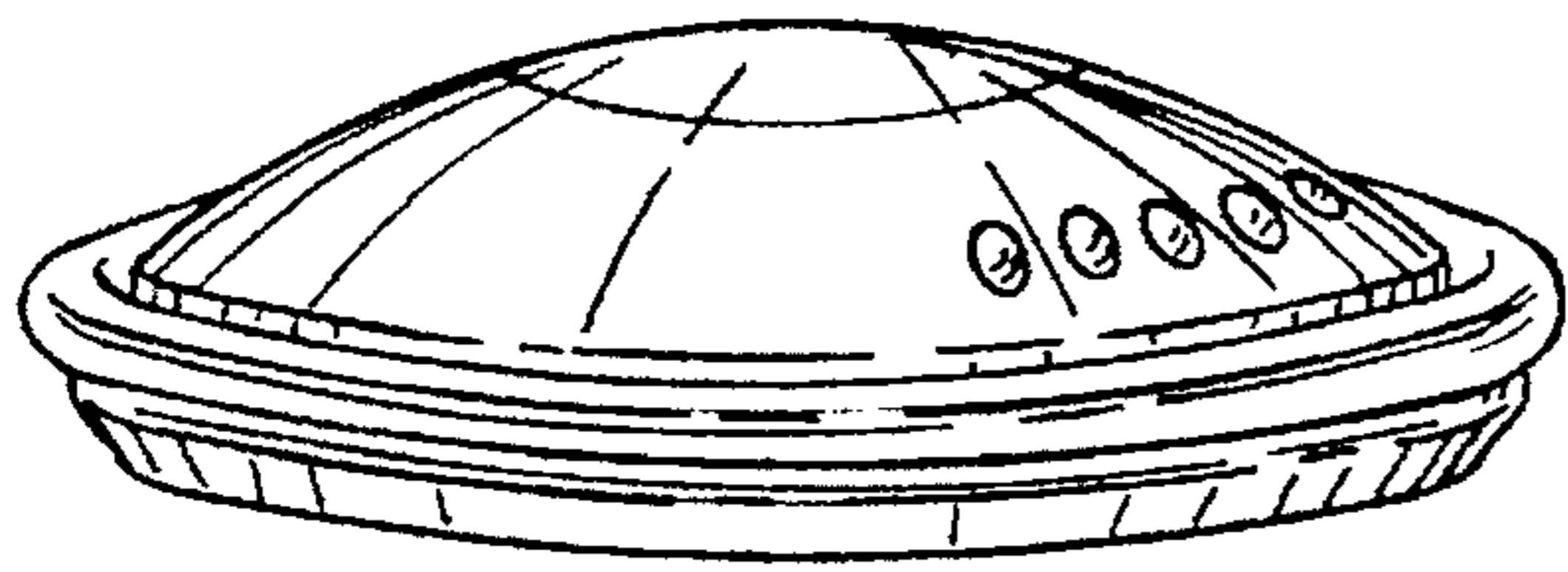

FIG. 1

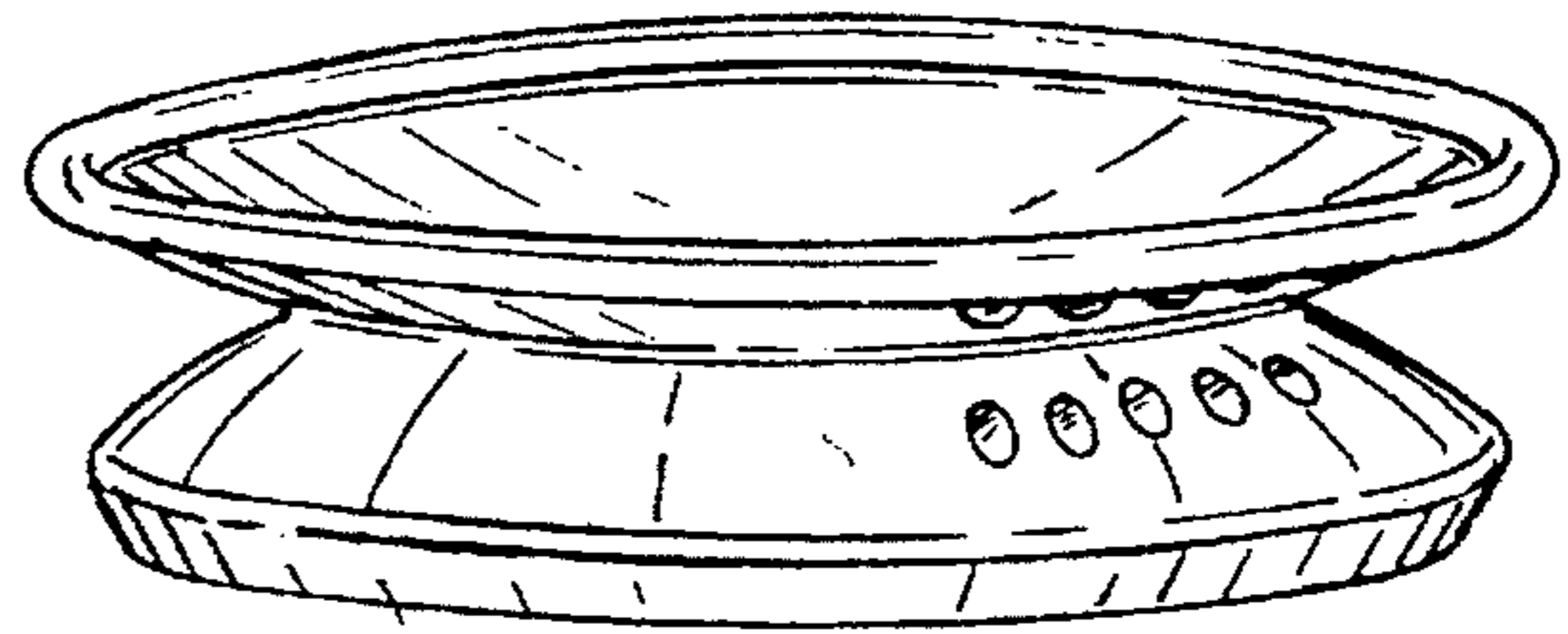

FIG. 2

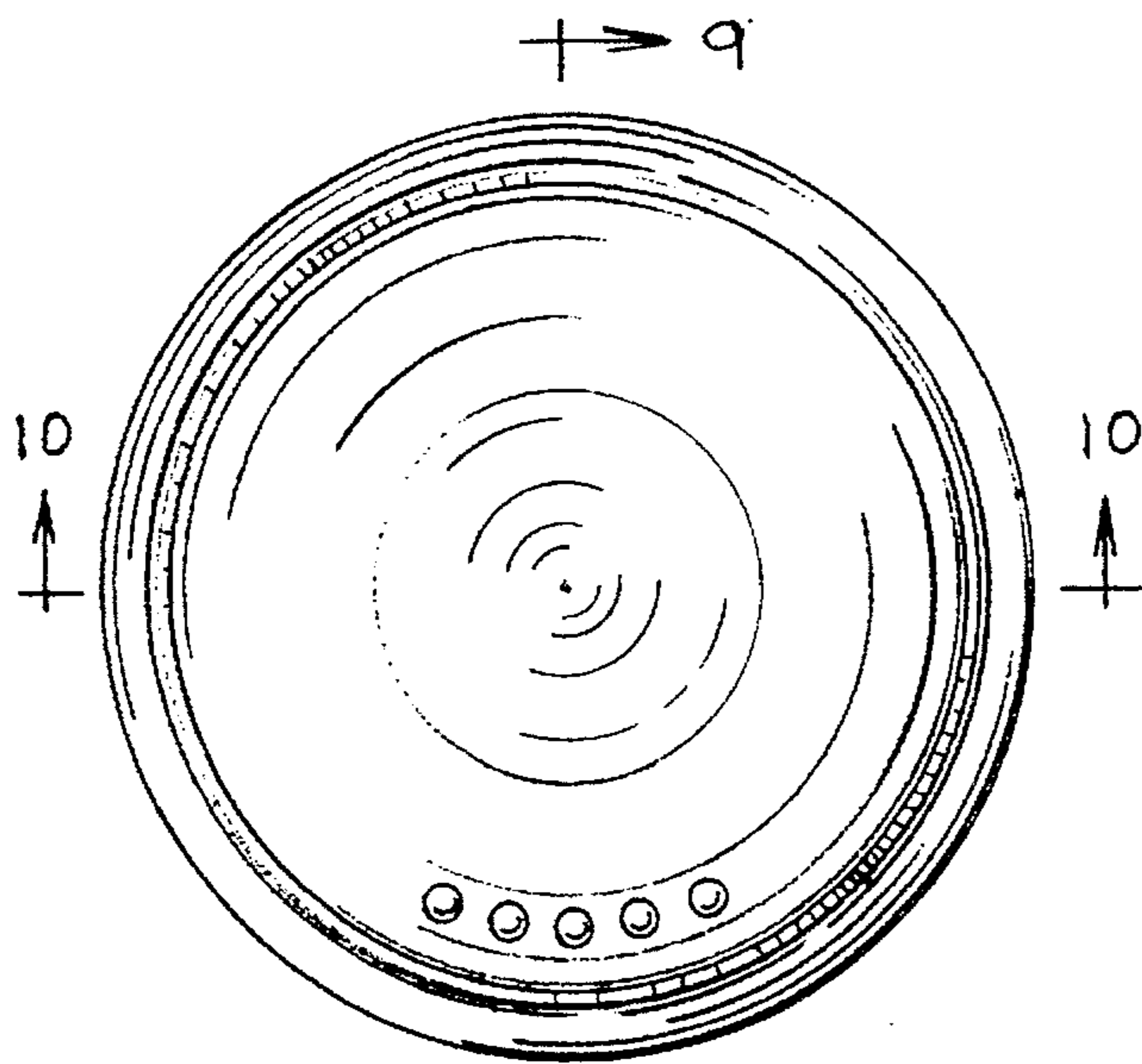

FIG. 3

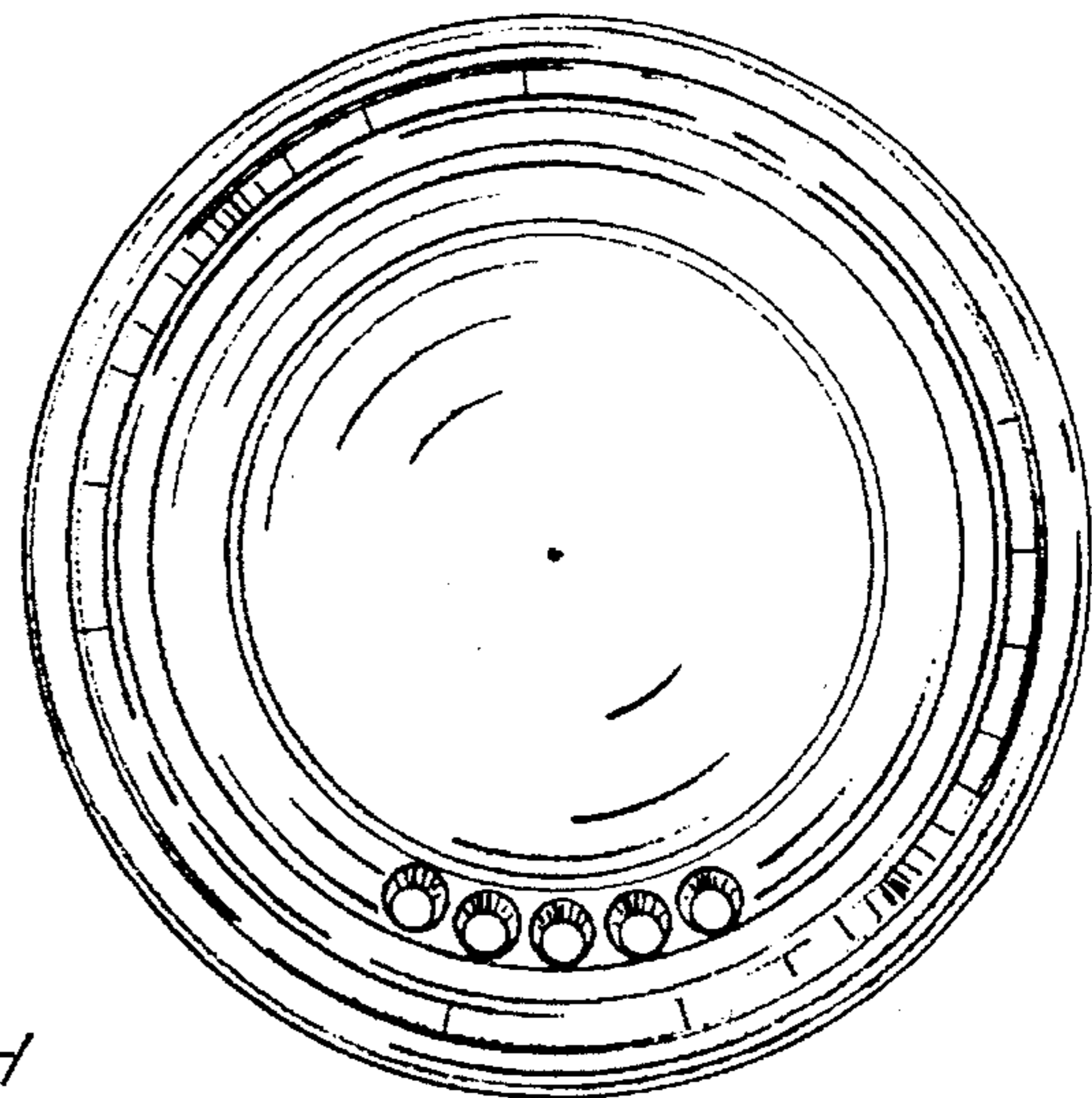

FIG. 4

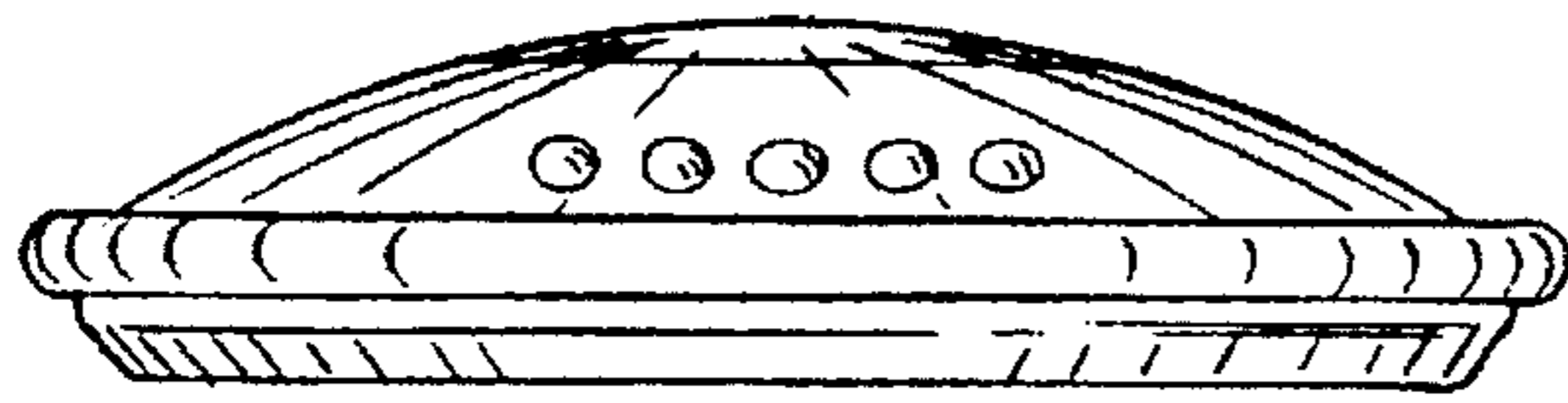

FIG. 5



FIG. 6

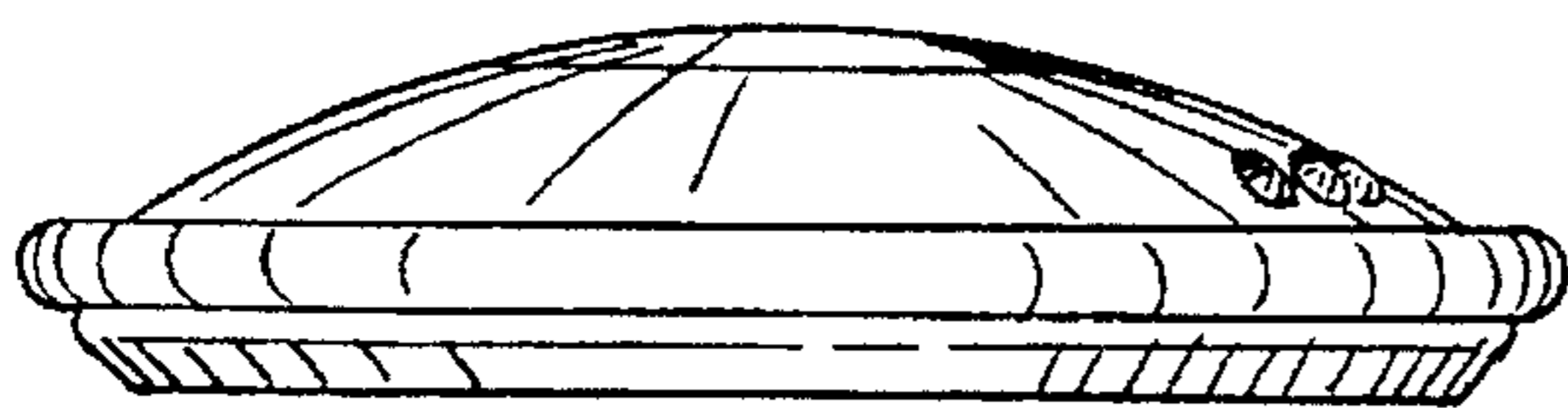

FIG. 7

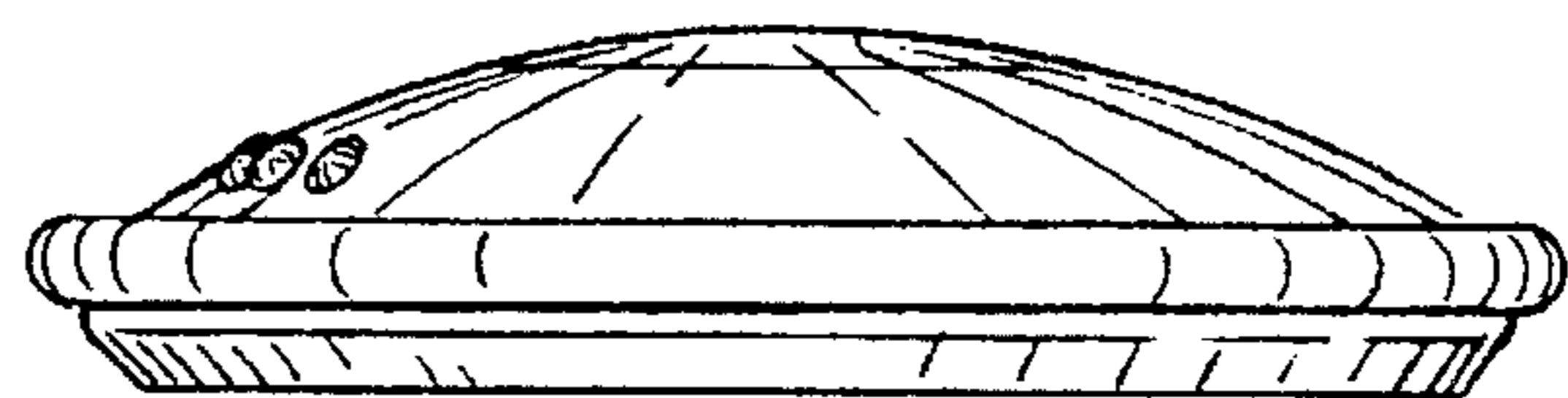

FIG. 8

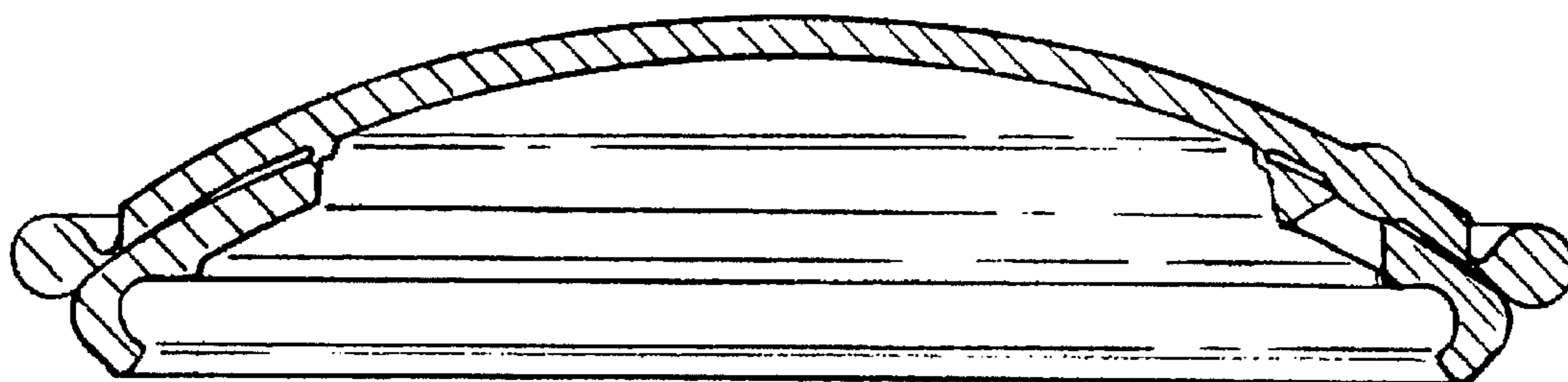

FIG. 9

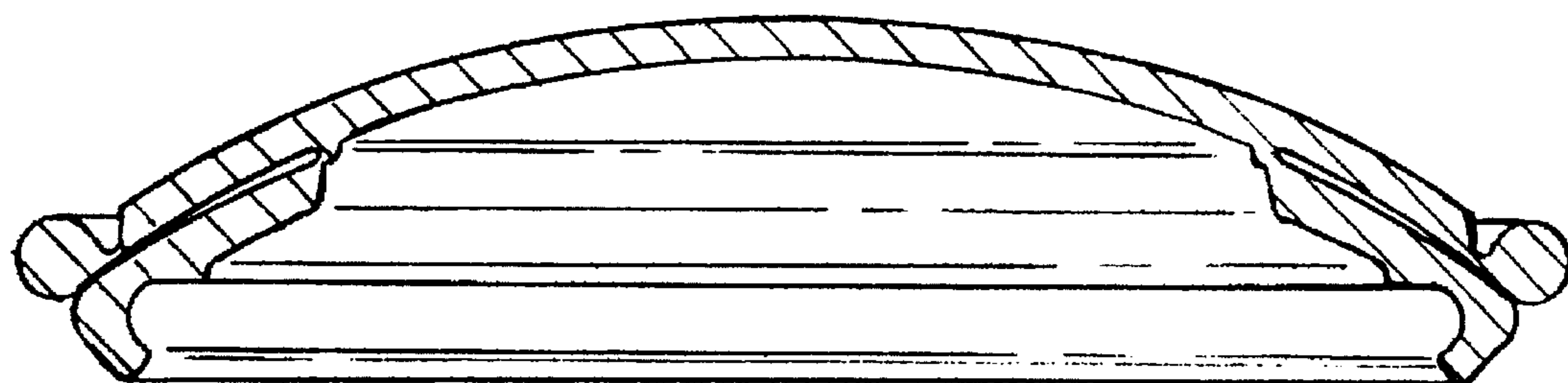

FIG. 10