



US00D381836S

United States Patent [19]

Martin

[11] Patent Number: Des. 381,836

[45] Date of Patent: **Aug. 5, 1997

[54] COMPUTER DESK

[75] Inventor: Jeffery G. Martin, Hudson, Ohio

[73] Assignee: The Little Tikes Company, Hudson, Ohio

[**] Term: 14 Years

[21] Appl. No.: 41,127

[22] Filed: Jul. 7, 1995

[51] LOC (6) Cl. 06-03

[52] U.S. Cl. D6/428

[58] Field of Search D6/419-428; 312/194-196, 312/204; 108/145-147; D21/121

[56] References Cited

U.S. PATENT DOCUMENTS

D. 269,196	5/1983	Appel et al.	D21/121
D. 282,218	1/1986	Catelli	D6/420 X
D. 289,114	4/1987	Dickson	D6/421
D. 311,753	10/1990	Westland et al.	D18/23
D. 318,768	8/1991	Westland et al.	D6/422
D. 322,729	12/1991	Diffrient	D6/487
D. 330,573	10/1992	Monneret	D21/121
D. 354,182	1/1995	Abraham et al.	D6/426
D. 355,312	2/1995	Wolff	D6/422
D. 358,434	5/1995	Brown et al.	D21/121
3,991,687	11/1976	Burr	108/132
4,345,803	8/1982	Heck	312/194
4,458,961	7/1984	Browning	312/196
5,322,025	6/1994	Sherman et al.	108/147
5,398,622	3/1995	Lubinskas et al.	108/145

OTHER PUBLICATIONS

Pp. 84 and 88, Computer desks; Dealers Office Equipment, Inc., 19300 Janacek Court, Waukesha, Wisconsin 53186. Publication date Apr. 1992.

Catalog page, Computer desks; Dealers Office Equipment, Inc., 19300 Janacek Court, Waukesha, Wisconsin 53186. Publication date Apr. 1992.

P. 70, Computer desks; Global Computer Supplies, 9139 Hemlock Drive, Hempstead, New York 11550. Publication date Jul. 1984.

Pp. 142, 158, 159, 162 and 163; Computer desks; Global Computer Supplies, 2318 East Del Amo Blvd., Dept. 31, Compton, California 90220. Publication date Jan., 1992.

Pp. 110, 111, 116, 117 and 119; Computer desks; Visible, A Subsidiary of Wallace Computer Services, Inc., 1750 Wallace Avenue, St. Charles, Illinois 60174. Publication date Fall/Winter 1992.

P. 211, Computer desk; Inmac, 2465 Augustine Drive, P. O. Box 58031, Santa Clara, California 95052-8031. Publication date Nov., 1987.

P. 85, Computer desks; Misco, One Misco Plaza, Holmdel, New Jersey 07733. Publication date Apr. 1992.

Pp. 60, 61 and 78; Computer desks; United Stationers Supply Company, 2200 East Golf Road, Des Plaines, Illinois 60016. Publication date 1988.

Pp. 81, Computer desks; United Stationers Supply Company, 2200 East Golf Road, Des Plaines, Illinois 60016. Published at least as early as Feb. 1994.

Pp. 75, 81 and 83, Computer Desk; Uarco Business Products, UARCO Incorporated, 121 North 9th Street, DeKalb, Illinois 60115. Publication date Spring 1992.

Primary Examiner—Carmen H. Vales-Lado
Attorney, Agent, or Firm—Richard B. O’Planick; Lisa B. Riedesel

[57] CLAIM

The ornamental design for a computer desk, as shown and described.

DESCRIPTION

FIG. 1 is a top front perspective view of a computer desk showing my new design;

FIG. 2 is a front elevational view thereof;

FIG. 3 is a rear elevational view thereof;

FIG. 4 is a top plan view thereof;

FIG. 5 is a bottom plan view thereof; and,

FIG. 6 is a left side elevational view thereof, the right side elevational view being a mirror image.

1 Claim, 6 Drawing Sheets

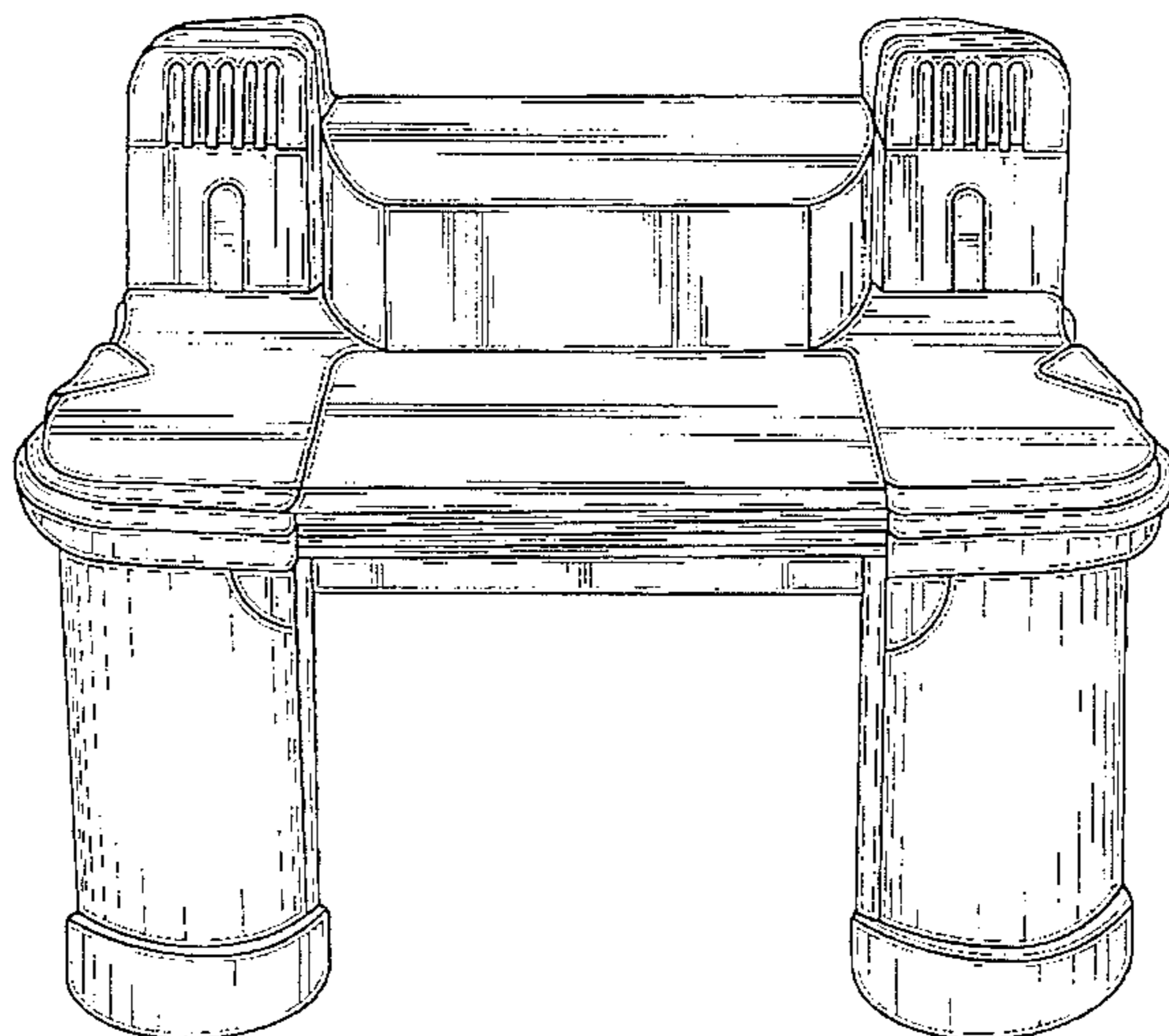

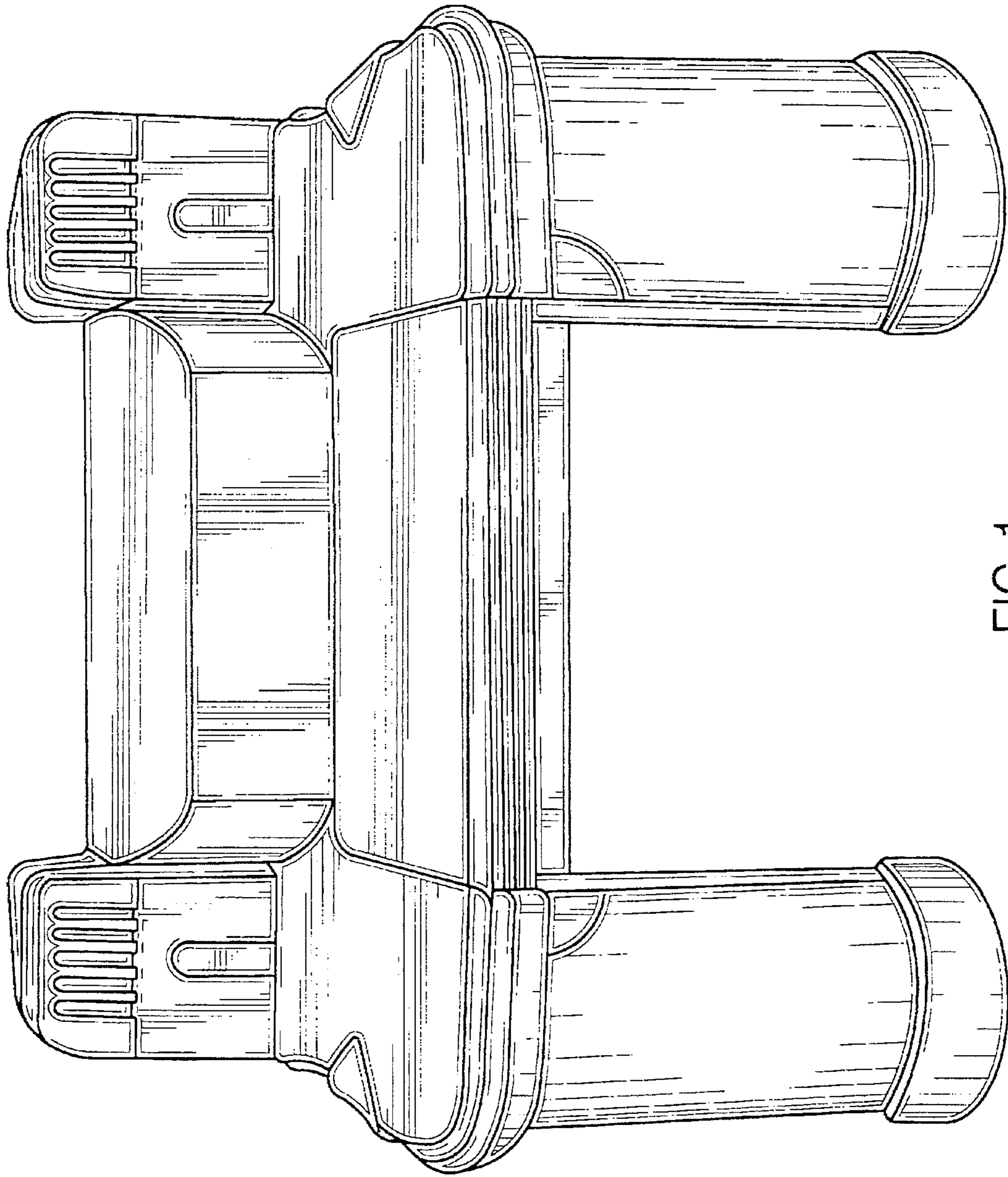

FIG. 1

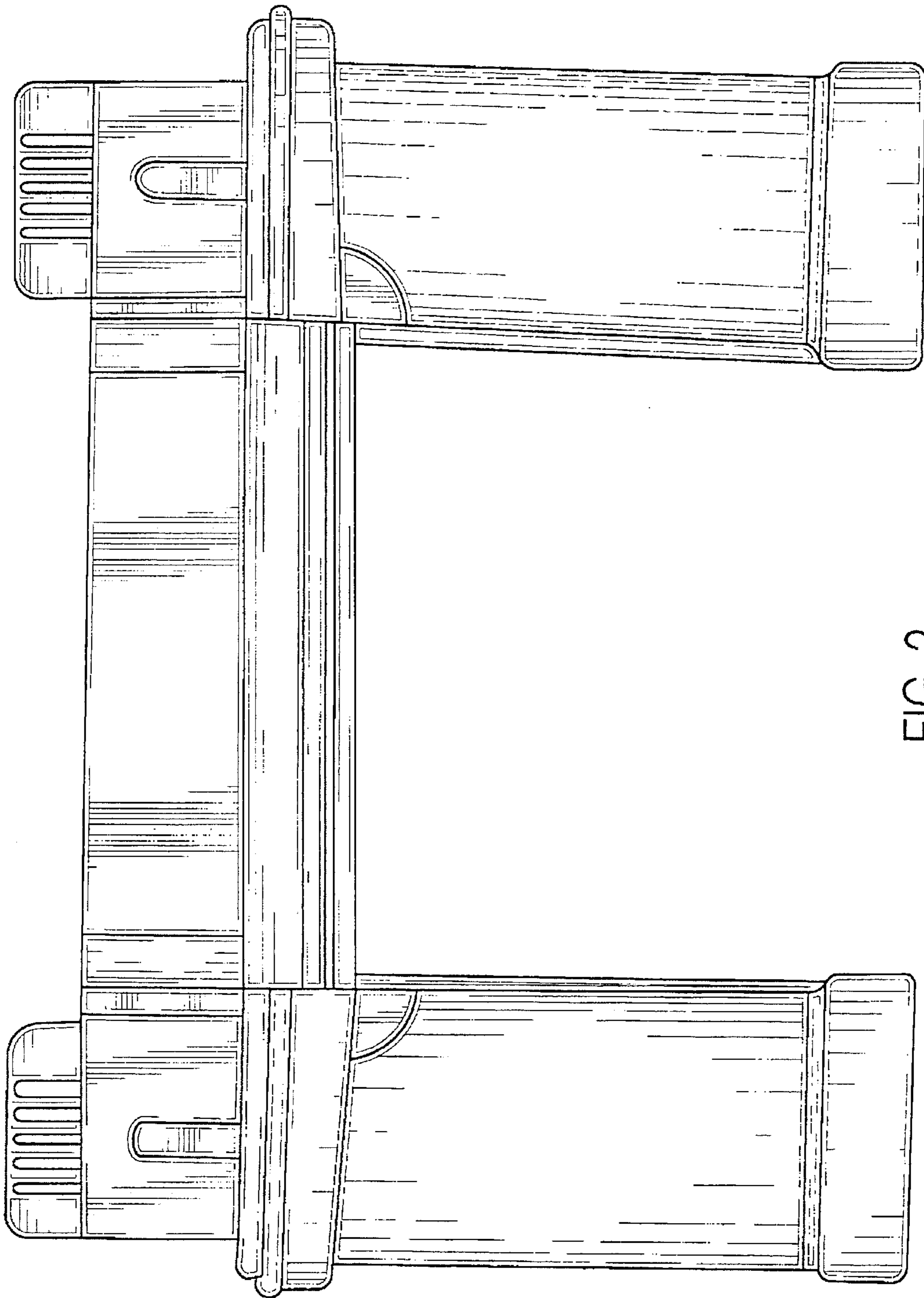

FIG. 2

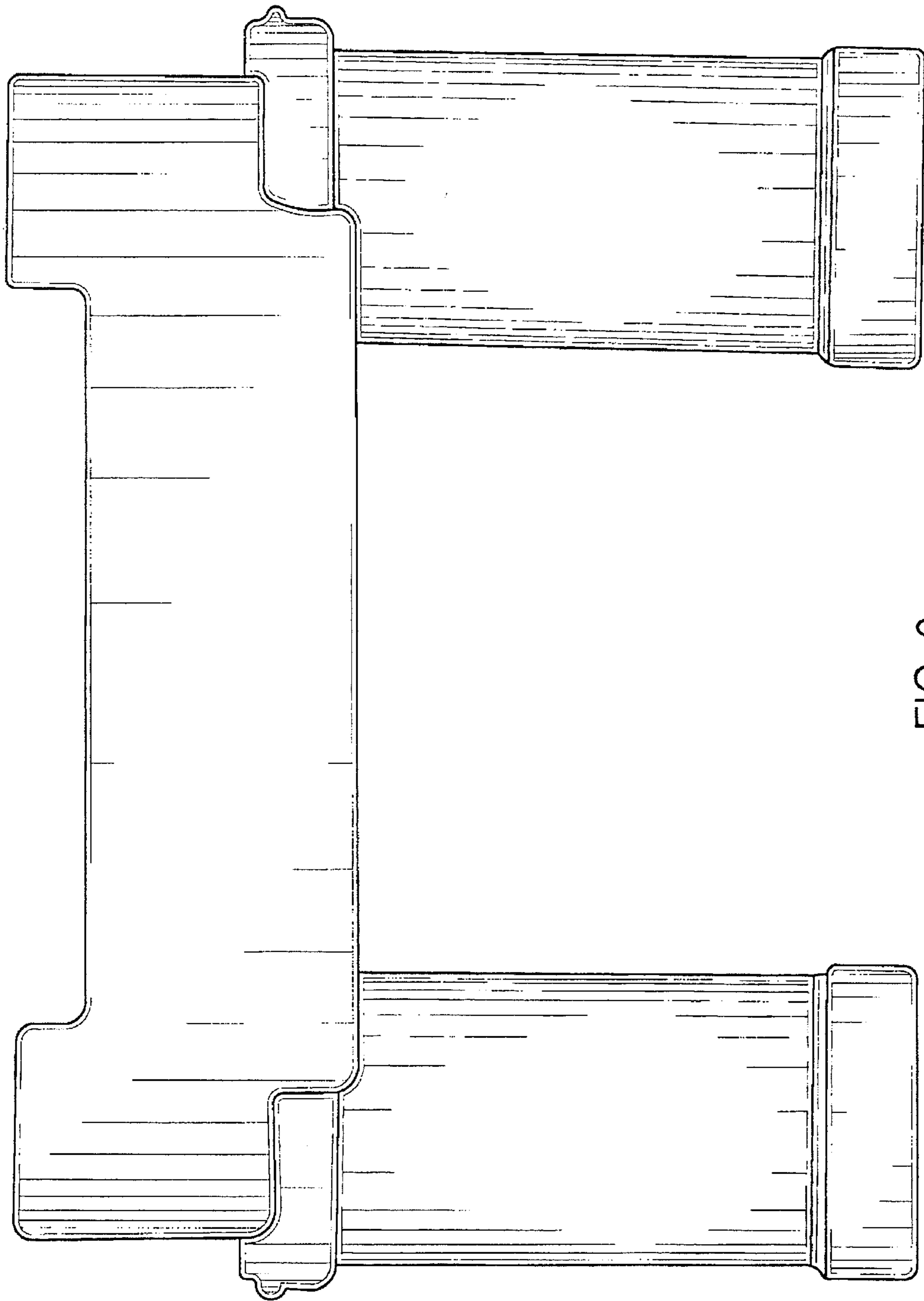

FIG. 3

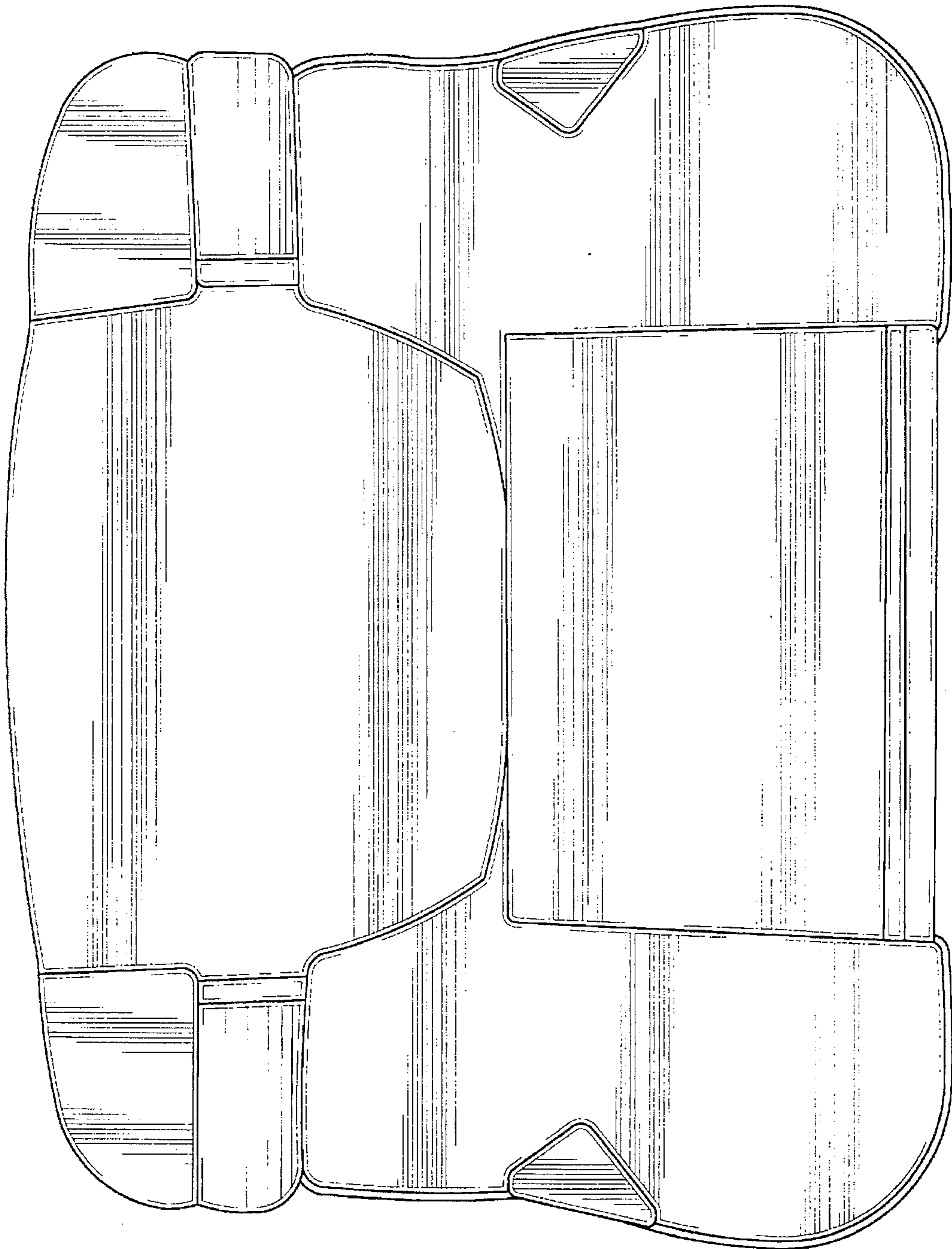

FIG. 4

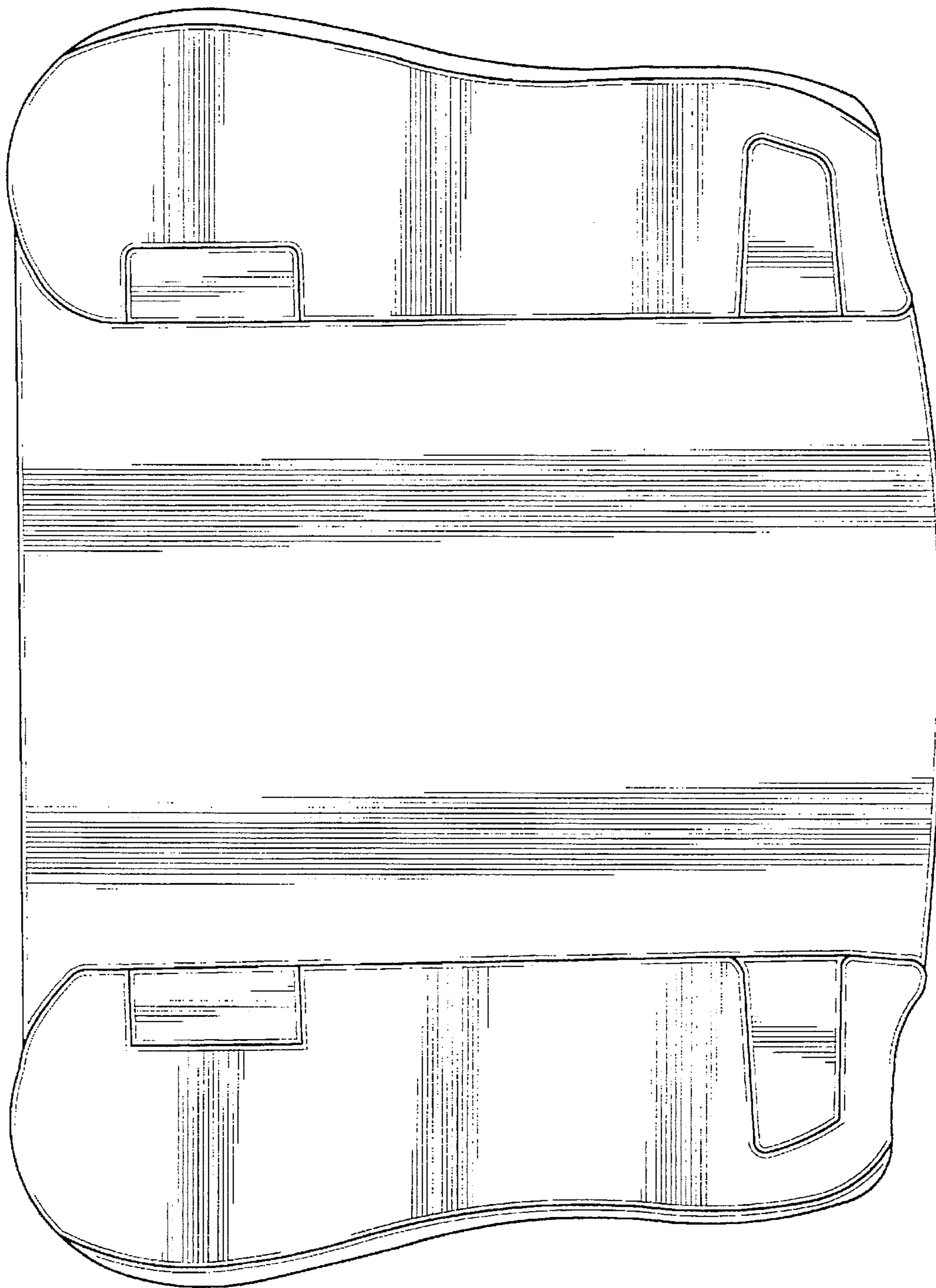

FIG. 5

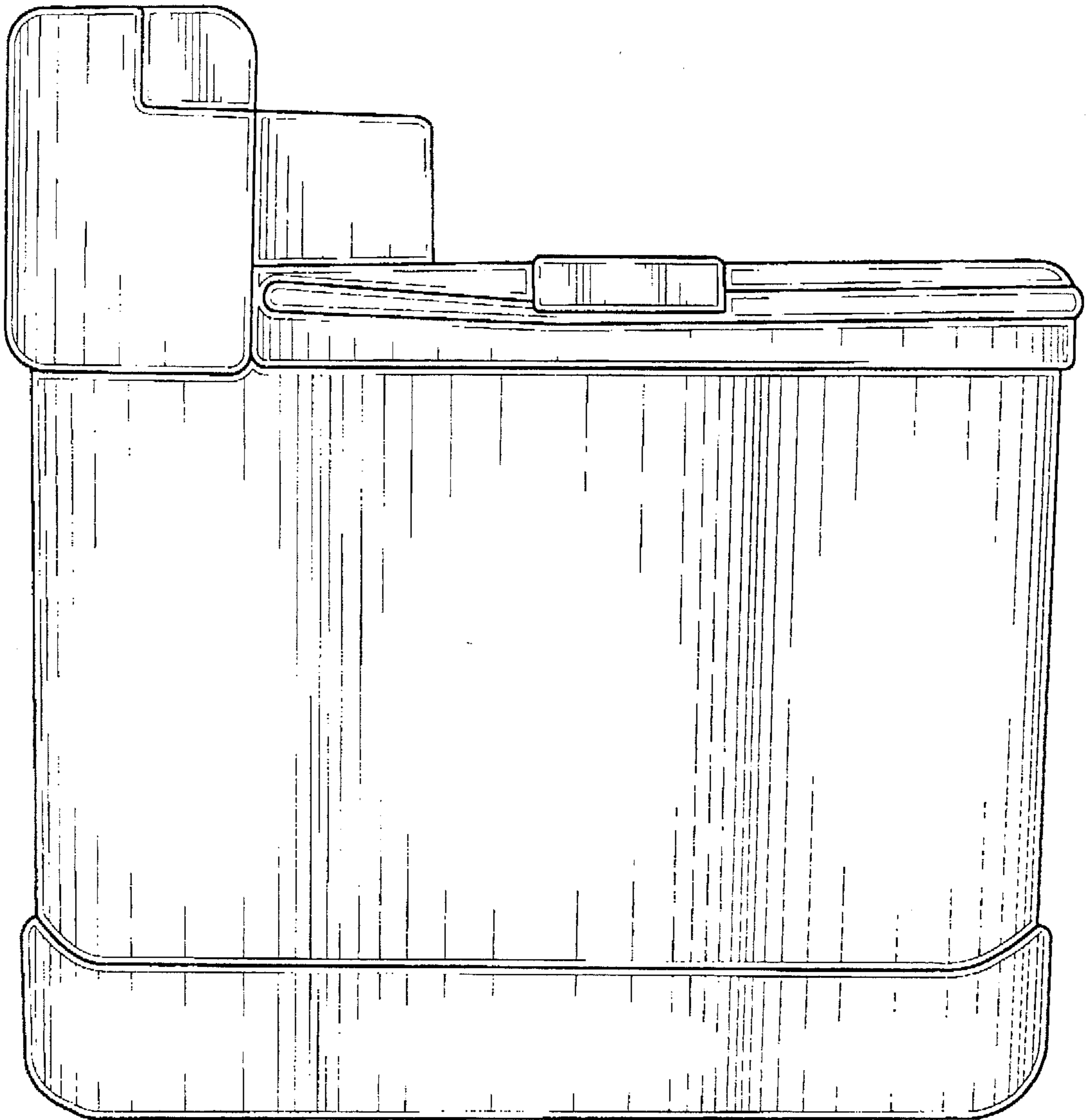

FIG. 6