



US00D381829S

United States Patent [19]

[11] Patent Number: **Des. 381,829**

Natuzzi et al.

[45] Date of Patent: ****Aug. 5, 1997**

[54] SEAT

[75] Inventors: **Pasquale Natuzzi**, Santeramo In Colle;
Arcangelo Scarati, Talsano, both of
Italy

[73] Assignee: **Industrie Natuzzi Spa**, Bari, Italy

[**] Term: **14 Years**

[21] Appl. No.: **55,453**

[22] Filed: **Jun. 5, 1996**

[51] LOC (6) Cl. **06-01**

[52] U.S. Cl. **D6/381; D6/334**

[58] Field of Search D6/334, 335, 336,
D6/364, 371, 373, 381, 500, 501, 502;
297/232

[56] References Cited

U.S. PATENT DOCUMENTS

D. 353,062	12/1994	Natuzzi et al.	D6/381
D. 358,505	5/1995	Natuzzi et al.	D6/381
D. 360,541	7/1995	Natuzzi et al.	D6/381
D. 362,560	9/1995	Natuzzi et al.	D6/381
D. 364,975	12/1995	Natuzzi et al.	D6/381
D. 368,600	4/1996	Riboldi	D6/381

OTHER PUBLICATIONS

Natuzzi Model 485, Apr. 1989, at International Home Furnishings Market in High Point, North Carolina.
 Natuzzi Model 882, Oct. 1991, at International Home Furnishings Market in High Point, North Carolina.
 Natuzzi Model 897, Apr. 1992, at International Home Furnishings Market in High Point, North Carolina.
 Natuzzi Model 1010, Apr. 1993, at International Home Furnishings Market in High Point, North Carolina.
 Natuzzi Model 1059, Apr. 1993, at International Home Furnishings Market in High Point, North Carolina.
 Natuzzi Model 1074, Oct. 1993, at International Home Furnishings Market in High Point, North Carolina.
 Natuzzi Model 1082, Oct. 1993, at International Home Furnishings Market in High Point, North Carolina.
 Natuzzi Model 1110, Oct. 1993, at International Home Furnishings Market in High Point, North Carolina.

Natuzzi Model 1130, Jan. 1994, at International Home Furnishings Market in High Point, North Carolina.
 Natuzzi Model 1177, Apr. 1994, at International Home Furnishings Market in High Point, North Carolina.
 Natuzzi Model 1202, Oct. 1994, at International Home Furnishings Market in High Point, North Carolina.
 Natuzzi Model 1210, Oct. 1994, at International Home Furnishings Market in High Point, North Carolina.
 Natuzzi Model 1237, Oct. 1994, at International Home Furnishings Market in High Point, North Carolina.
 Natuzzi Model 1264, Mar. 1995, at International Home Furnishings Market in High Point, North Carolina.
 Natuzzi Model 1290, Mar. 1995, at International Home Furnishings Market in High Point, North Carolina.

(List continued on next page.)

Primary Examiner—Gary D. Watson
Attorney, Agent, or Firm—Bell, Seltzer, Park & Gibson, P.A.

[57] CLAIM

The ornamental design for a seat, as shown and described.

DESCRIPTION

FIG. 1 is a front perspective view of a seat showing our new design in the form of a sofa;
 FIG. 2 is a front elevational view thereof;
 FIG. 3 is a top plan view thereof;
 FIG. 4 is a right side elevational view, the left side being a mirror image thereof;
 FIG. 5 is a rear perspective view thereof;
 FIG. 6 is a front elevational view of a seat showing our new design in the form of a loveseat; and,
 FIG. 7 is a front elevational view of a seat showing our new design in the form of a chair.
 The broken lines shown herein are for illustrative purposes only and form no part of the claimed design.
 The rear views of FIGS. 6 and 7 are like FIG. 5, the difference being a matter of length.
 The end views of FIGS. 6 and 7 are like that shown in FIG. 4.
 FIGS. 1 and 5 have been shown on an enlarged scale.

1 Claim, 3 Drawing Sheets

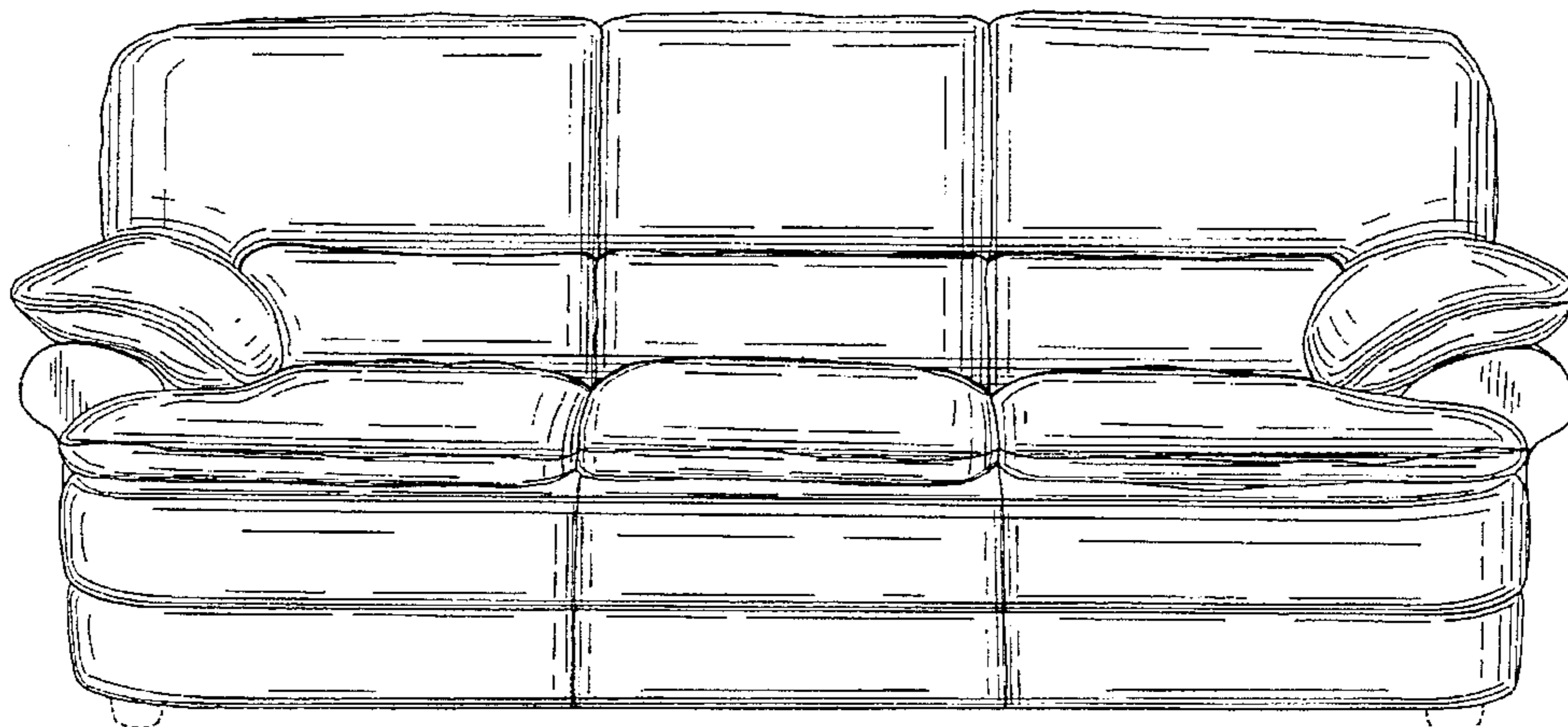

OTHER PUBLICATIONS

Natuzzi Model 1291, Mar., 1995, at International Home Furnishings Market in High Point, North Carolina.

Natuzzi Model 1296, Mar., 1995 at International Home Furnishings Market in High Point, North Carolina.

Natuzzi Model 1339, Sep. 1995, at International Home Furnishings Market in High Point, North Carolina.

Natuzzi Model 1345, Sep. 1995, at International Home Furnishings Market in High Point, North Carolina.

Natuzzi Model 1370, Oct. 1995, at International Home Furnishing Market in High Point, North Carolina.

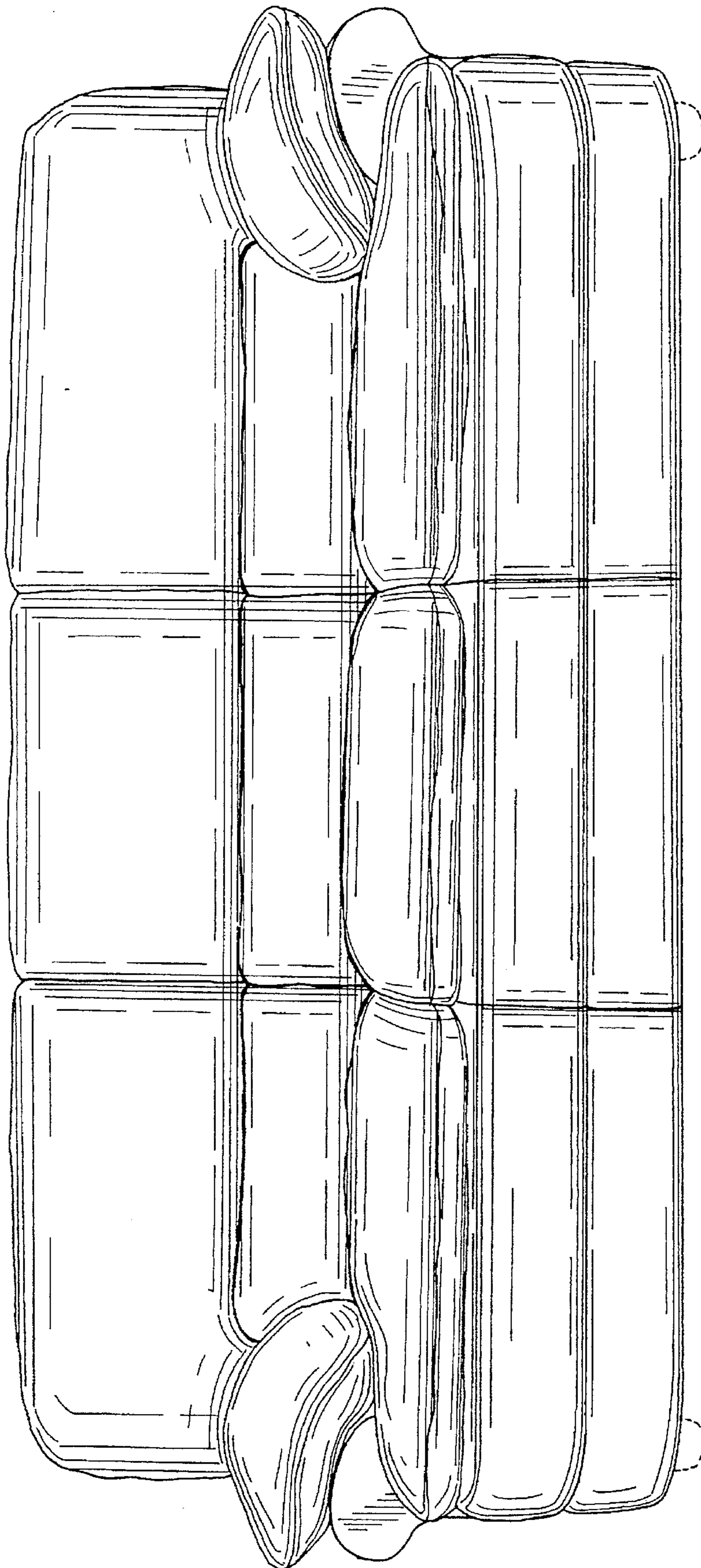

FIG. 1.

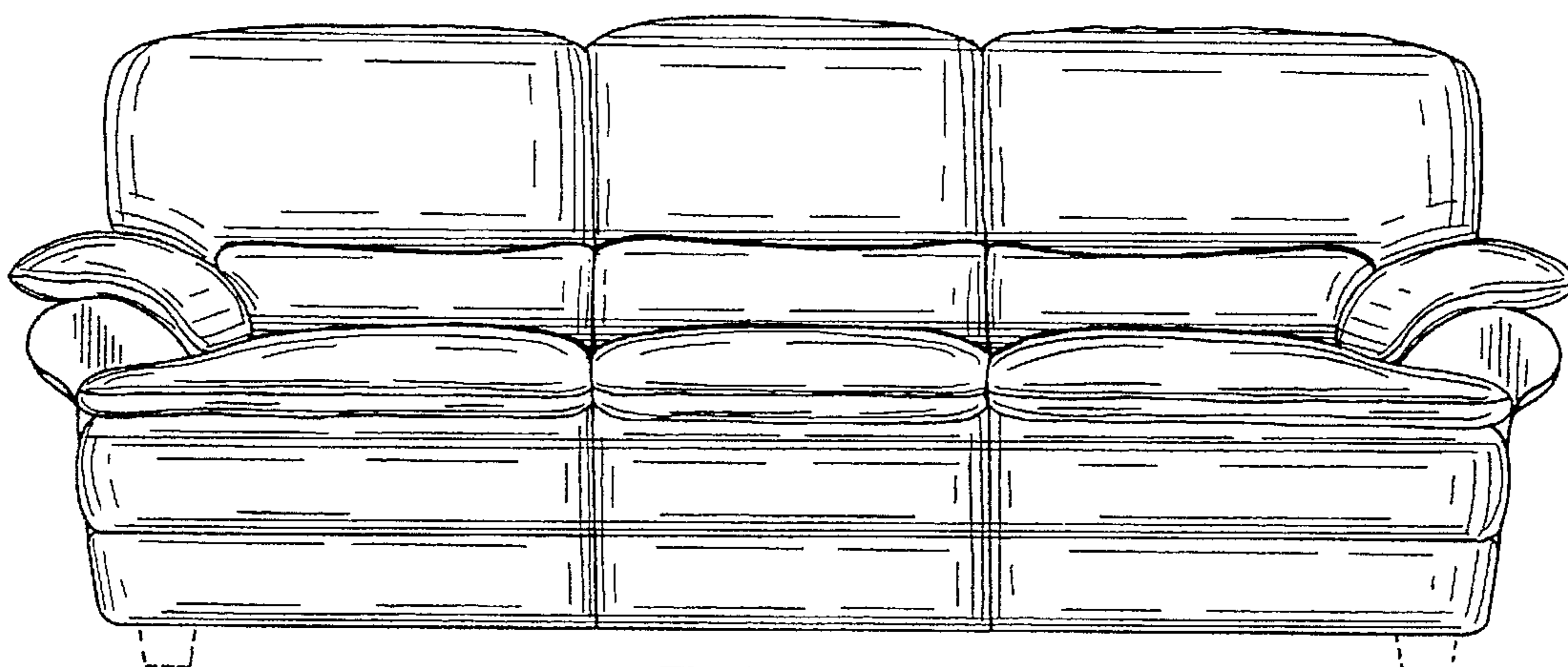

FIG. 2.

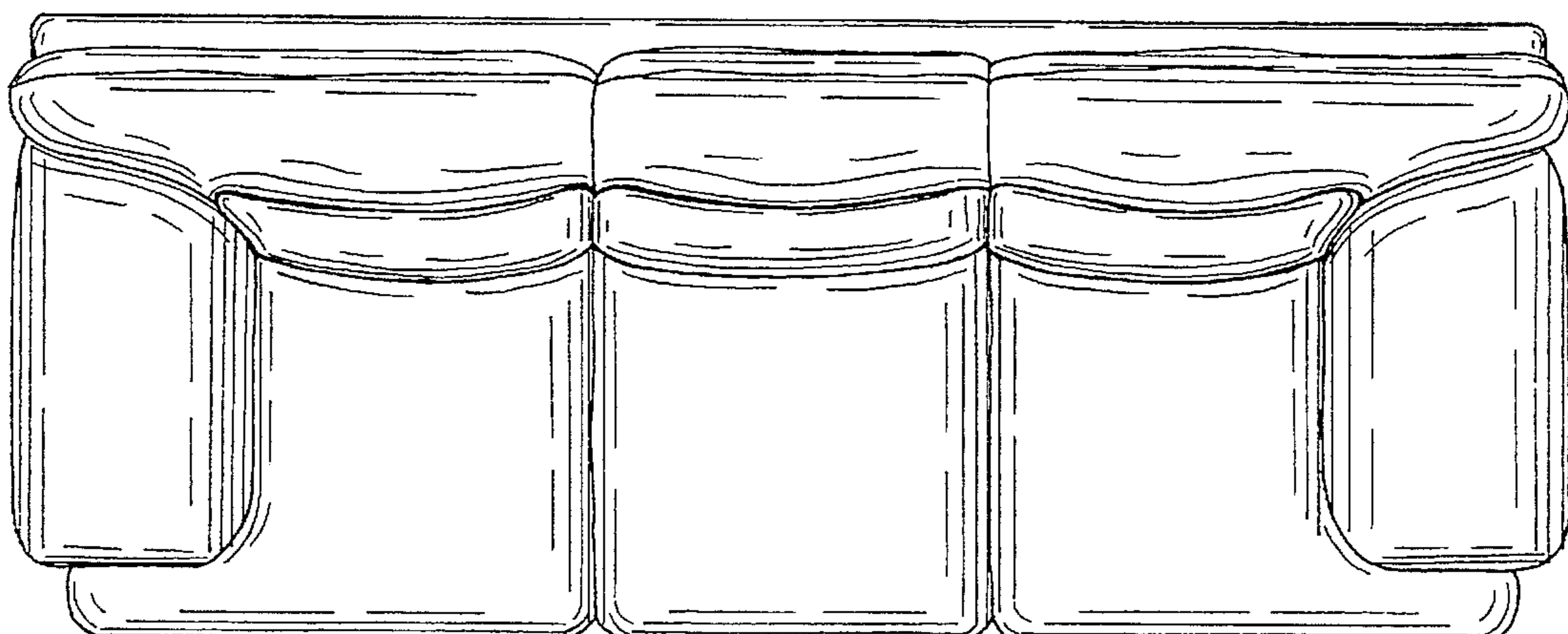

FIG. 3.

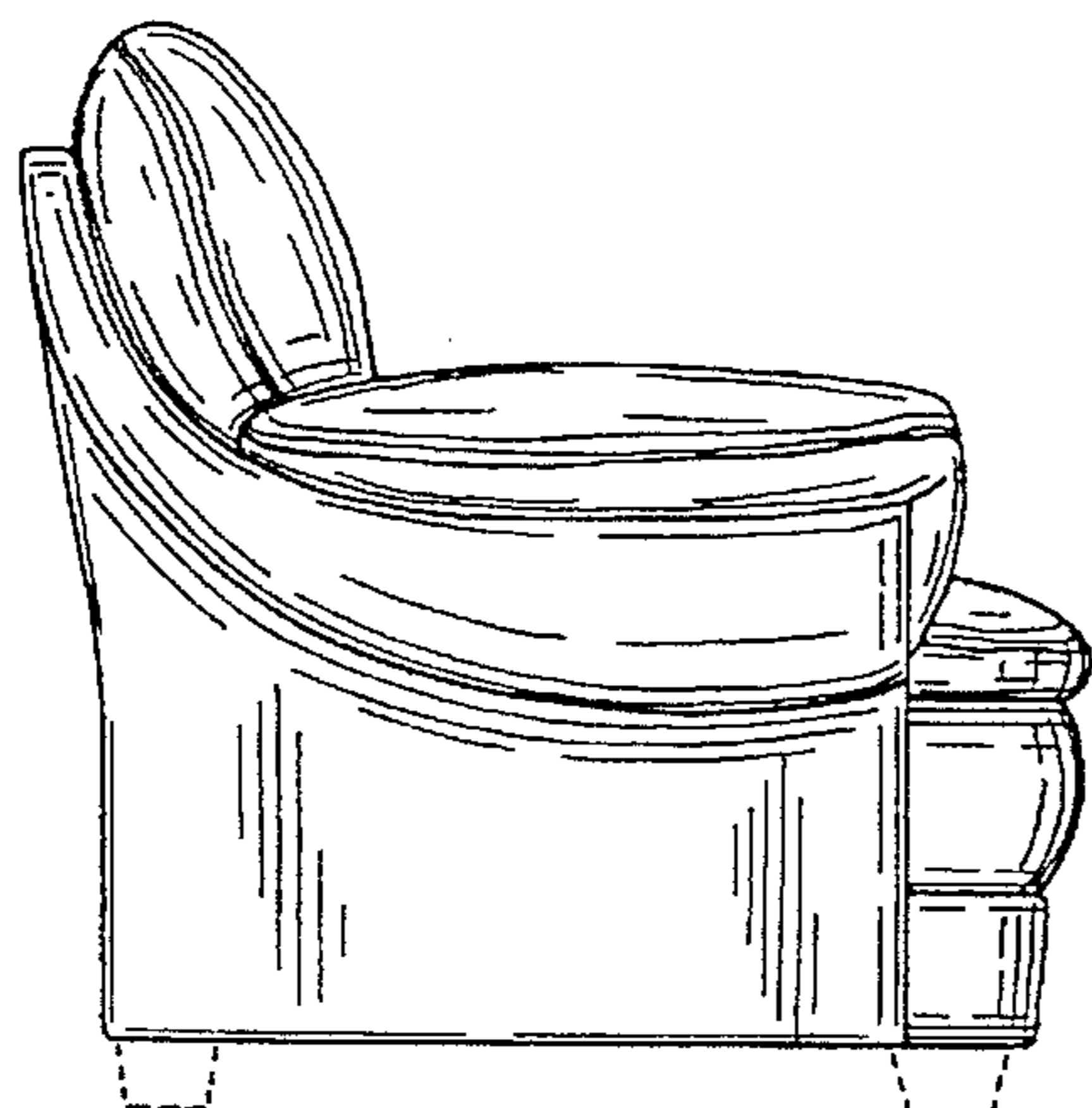

FIG. 4.

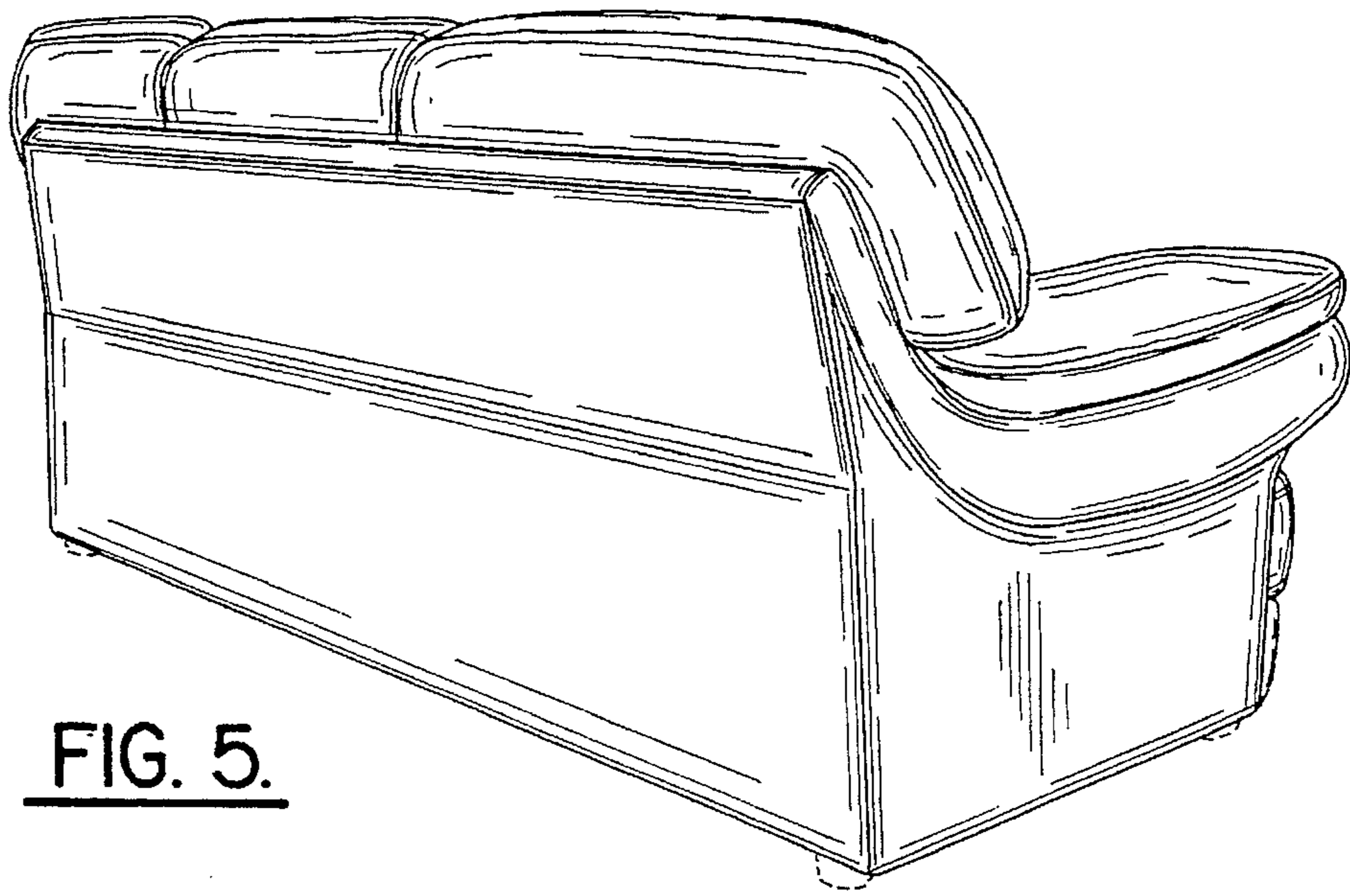

FIG. 5.

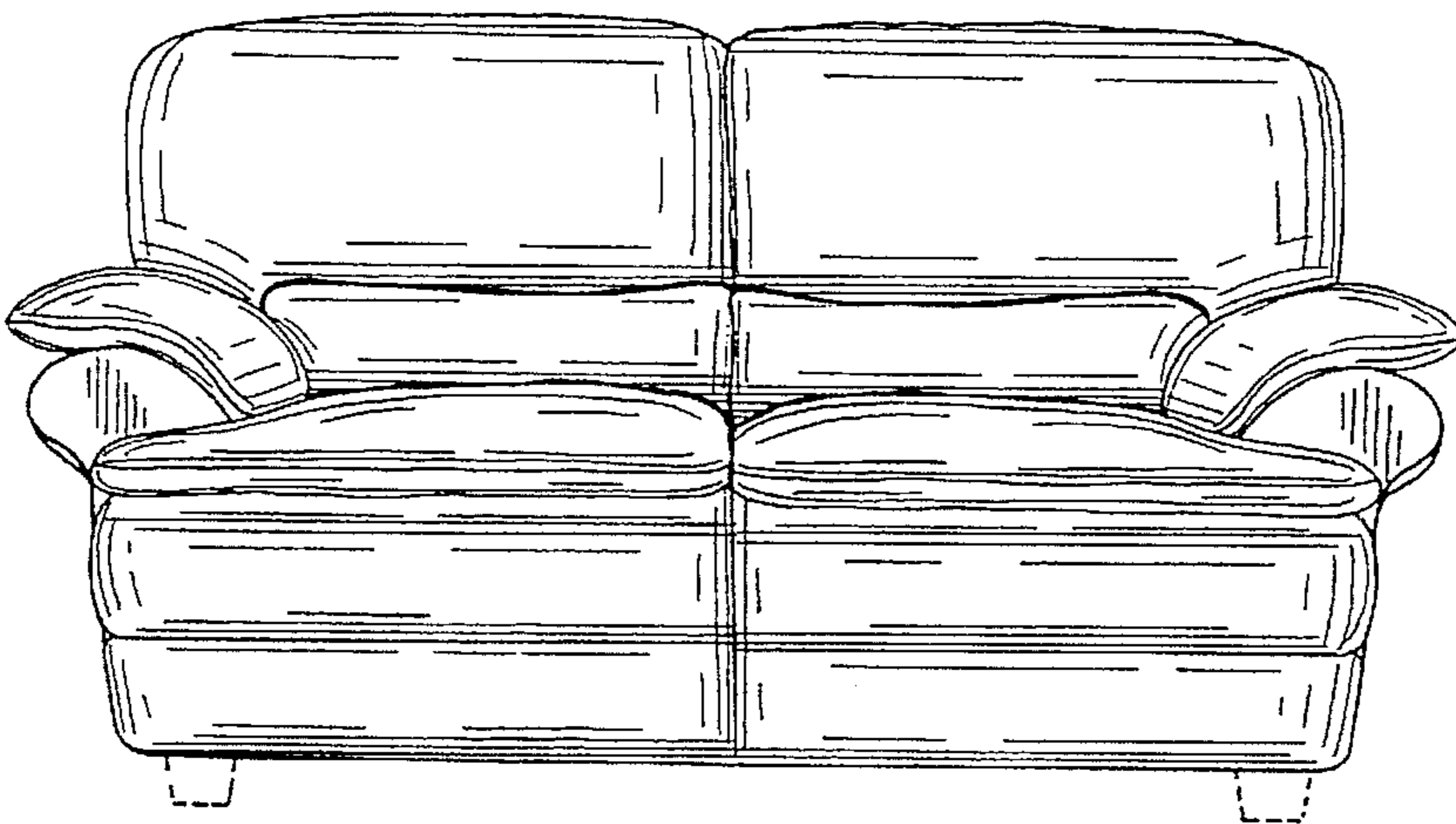

FIG. 6.

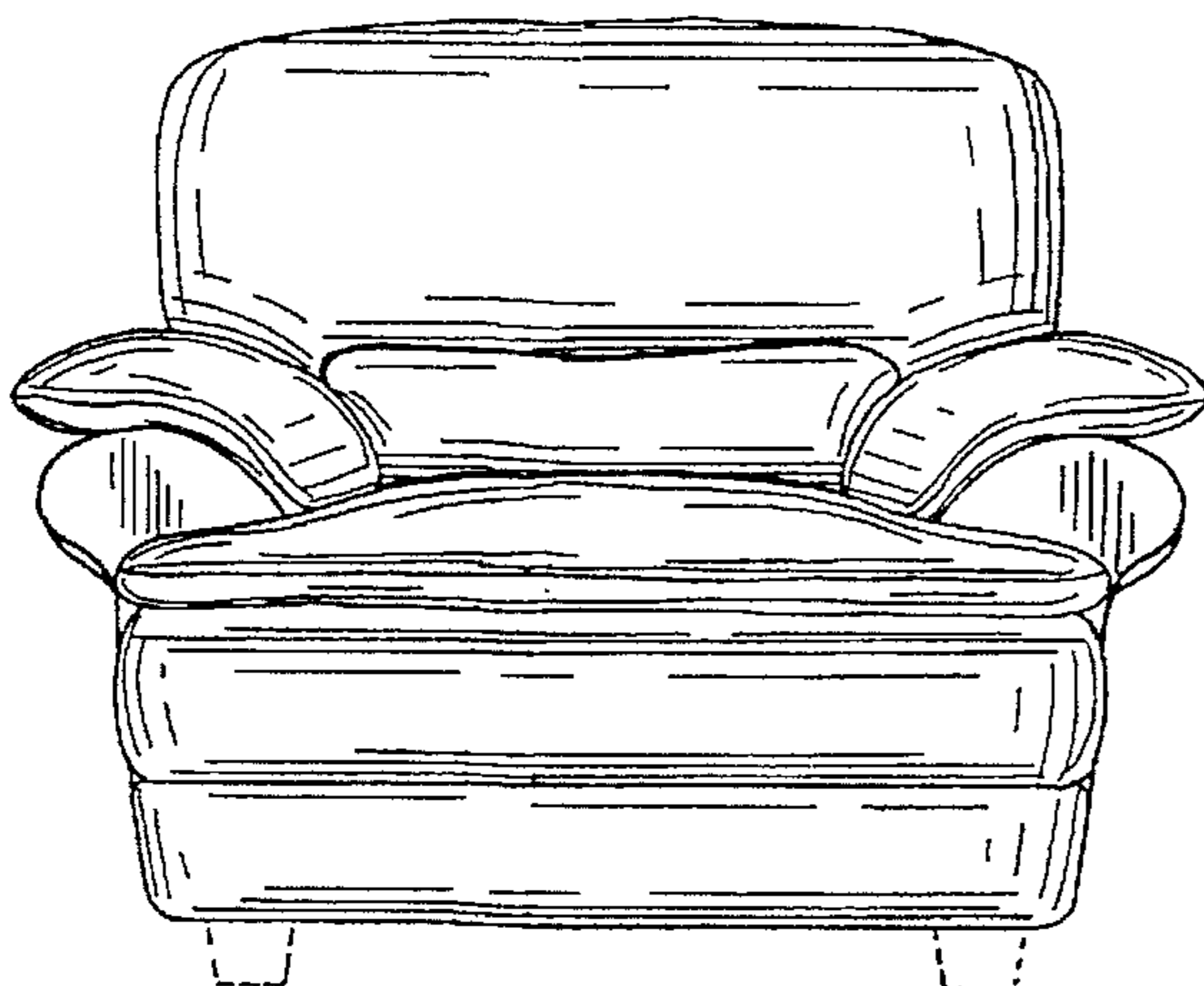

FIG. 7.