



US00D381659S

United States Patent [19]

[11] Patent Number: Des. 381,659

Tokiyama et al.

[45] Date of Patent: **Jul. 29, 1997

[54] MOBILE RADIO

[75] Inventors: **Masaru Tokiyama**, Coral Springs; **William H. Robertson**, Plantation, both of Fla.; **Richard E. Murray**, Arlington, Tex.

[73] Assignee: **Motorola, Inc.**, Schaumburg, Ill.

[**] Term: **14 Years**

[21] Appl. No.: **34,376**

[22] Filed: **Feb. 3, 1995**

[51] LOC (6) Cl. **14-03**

[52] U.S. Cl. **D14/194; D14/198**

[58] Field of Search D14/124, 137, D14/138, 168, 188-189, 191-198, 257, 265, 299; 455/344, 347, 350, 351

[56] References Cited

U.S. PATENT DOCUMENTS

D. 314,768	2/1991	Taniguchi	D14/194
D. 329,849	9/1992	Tokiyama et al.	D14/137
D. 334,744	4/1993	Tokiyama et al.	D14/137
D. 350,756	9/1994	Zelios	D14/192 X
D. 352,714	11/1994	Ichikawa et al.	D14/188
D. 369,808	5/1996	Hon et al.	D14/191

Primary Examiner—Sandra L. Morris
Assistant Examiner—Nanda Bondade
Attorney, Agent, or Firm—Andrew S. Fuller

[57] CLAIM

The ornamental design for a mobile radio, as shown and described.

DESCRIPTION

FIG. 1 is a front elevational view of a mobile radio showing our new design;

FIG. 2 is a right elevational view thereof;

FIG. 3 is a rear elevational view thereof;

FIG. 4 is a left elevational view thereof;

FIG. 5 is a top plan view thereof;

FIG. 6 is a bottom plan view thereof;

FIG. 7 is an isomeric view showing the front, right side, and top thereof; and

FIG. 8 is a front elevational view of an alternate embodiment of FIG. 1;

FIG. 9 is a right side elevational view of FIG. 8;

FIG. 10 is a rear elevational view of FIG. 8;

FIG. 11 is a left side elevational view of FIG. 8;

FIG. 12 is a top plan view of FIG. 8;

FIG. 13 is a bottom plan view of FIG. 8; and,

FIG. 14 is an isometric view showing the front, right side and top of FIG. 8.

The broken lines shown in FIG. 14, are included for the purpose of illustrating environmental elements only and form no part of the claimed design.

1 Claim, 8 Drawing Sheets

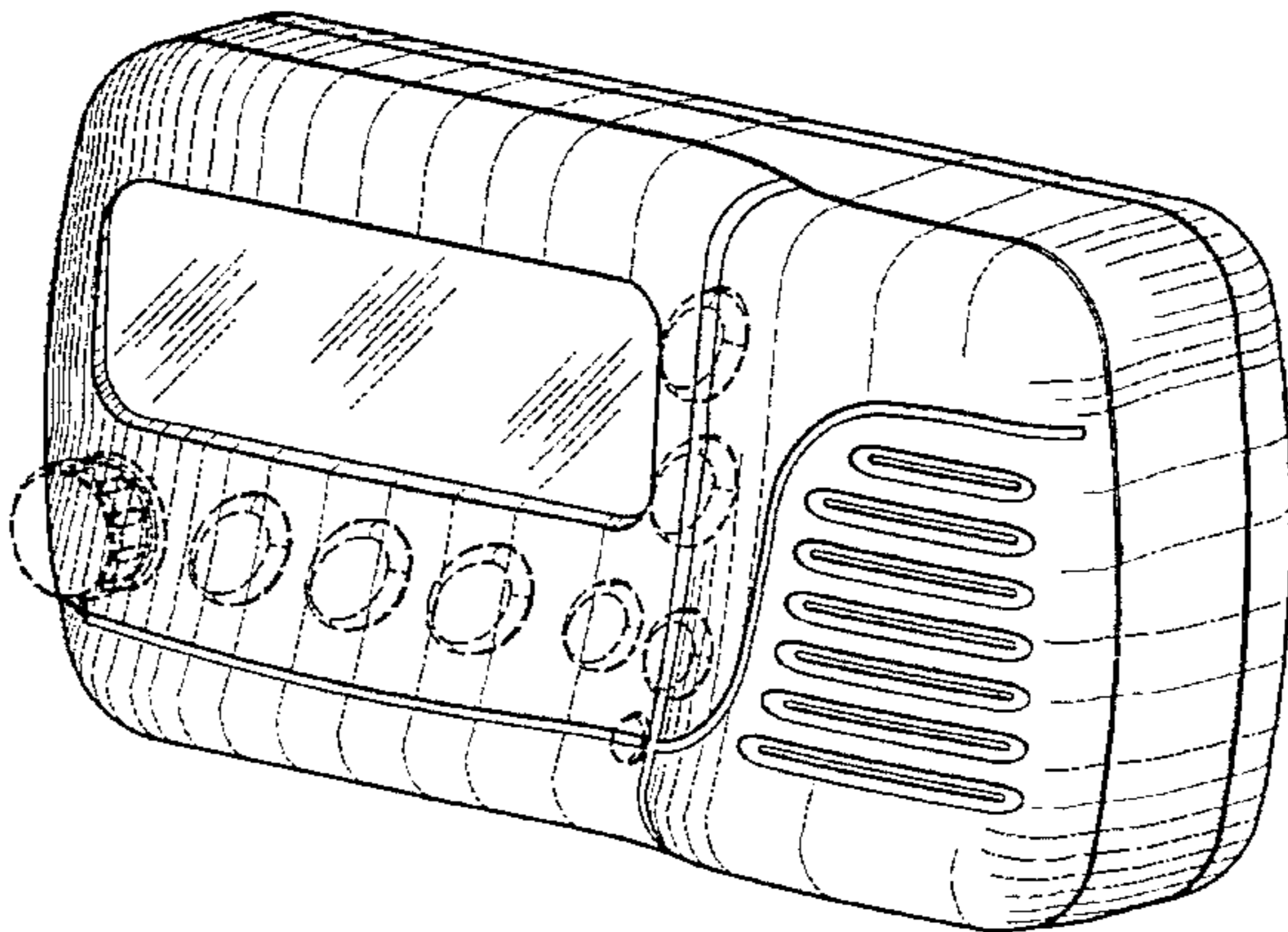
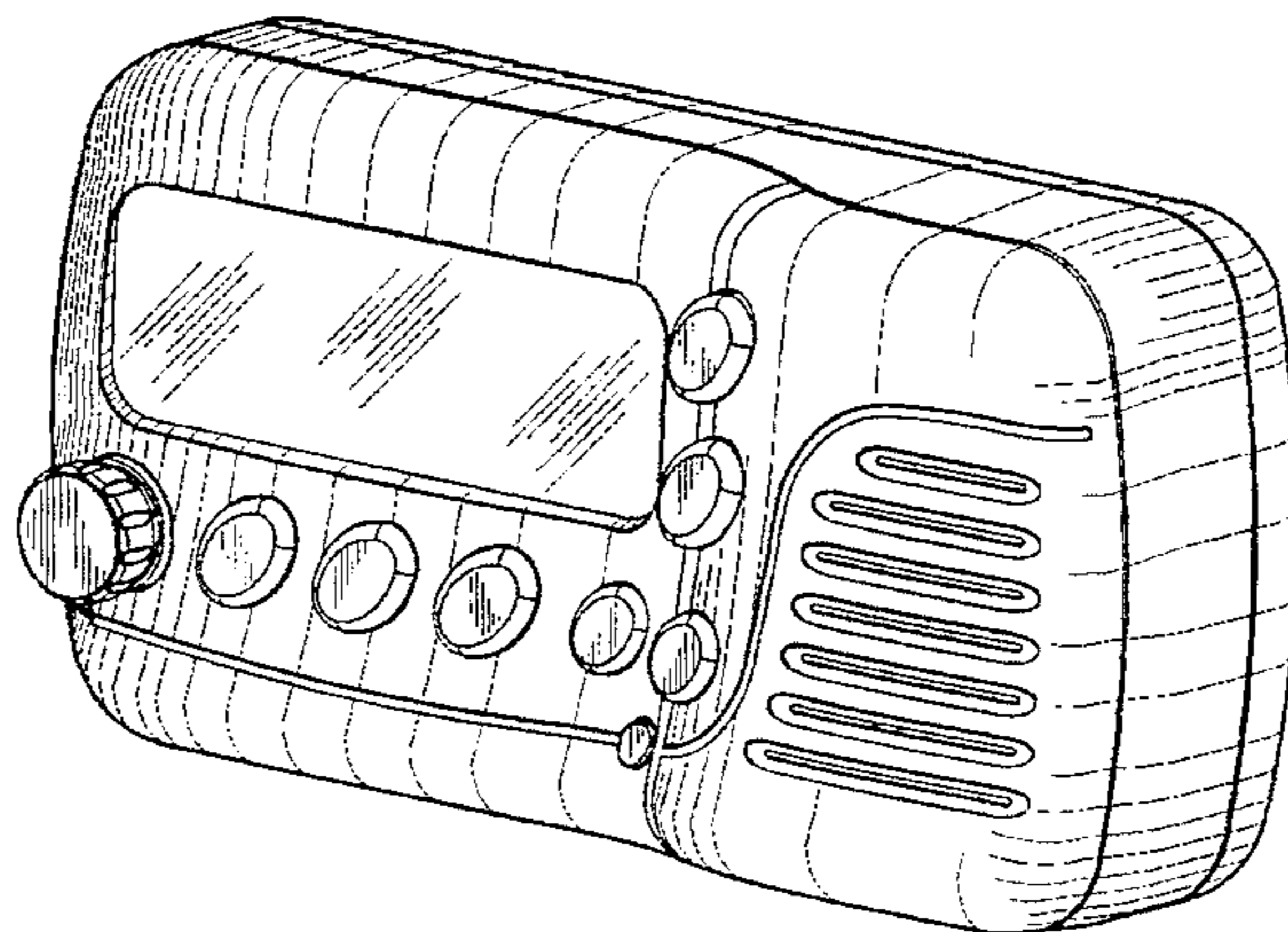

FIG. 2

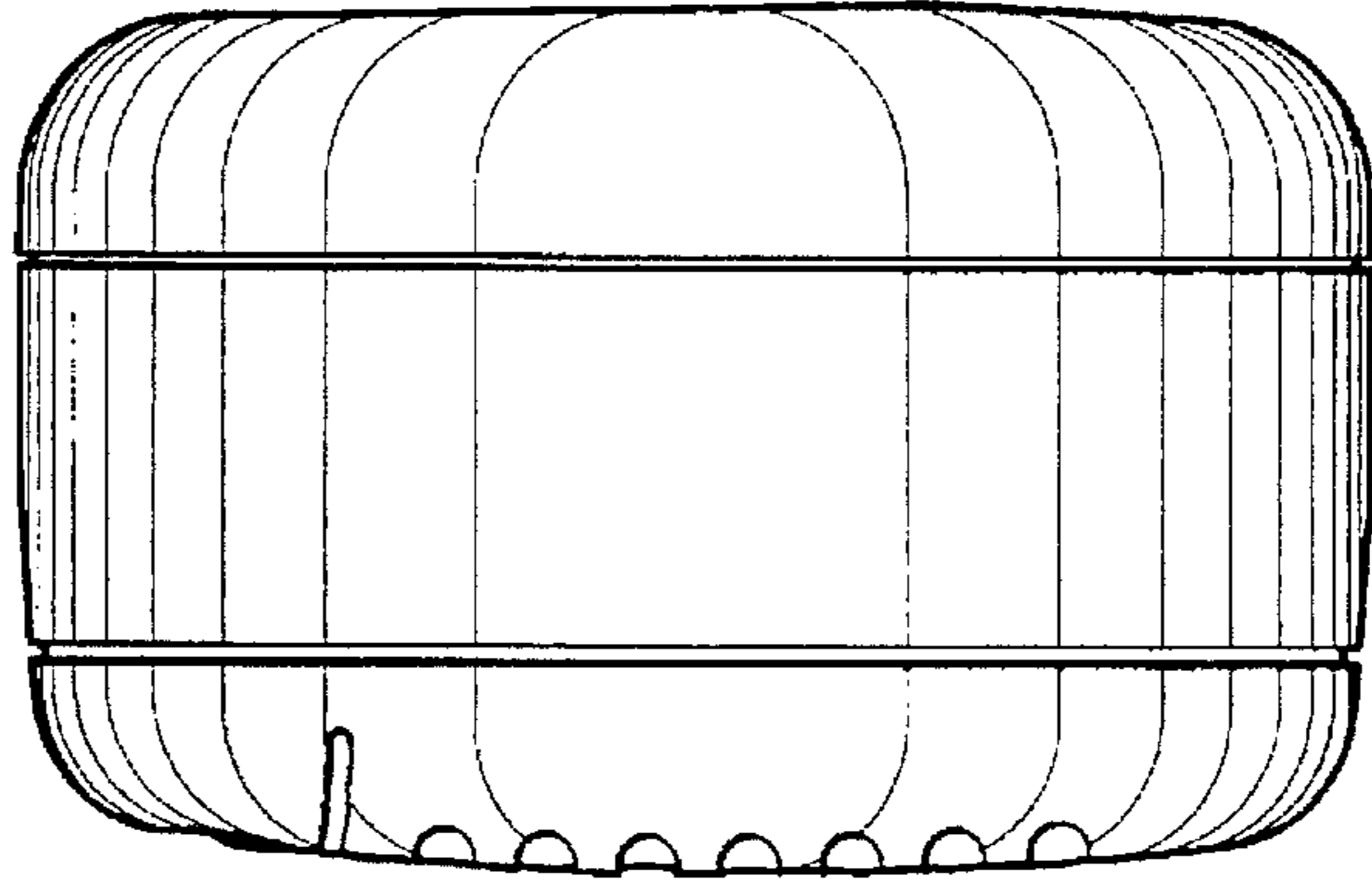

FIG. 1

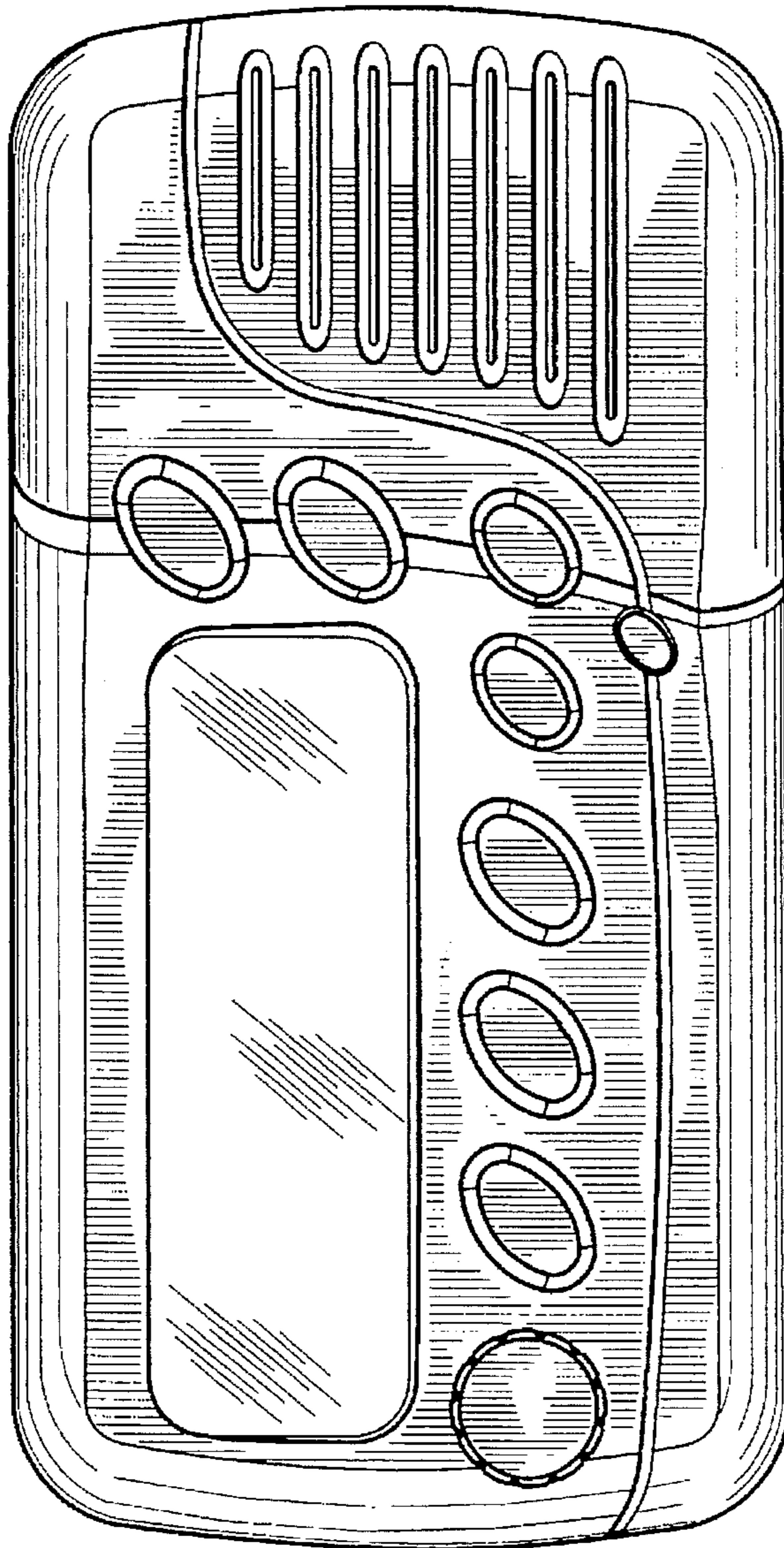

FIG. 4

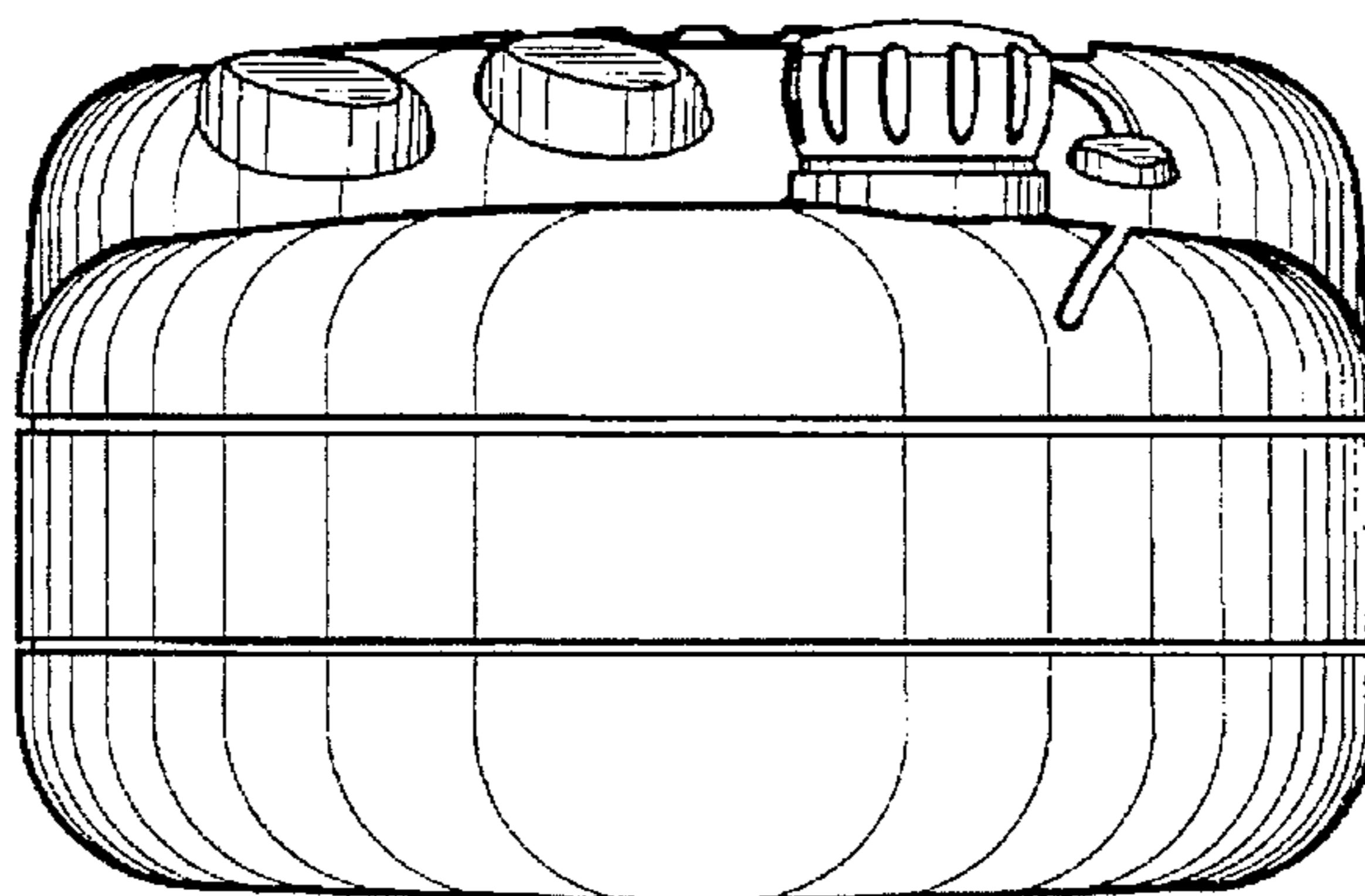

FIG. 3

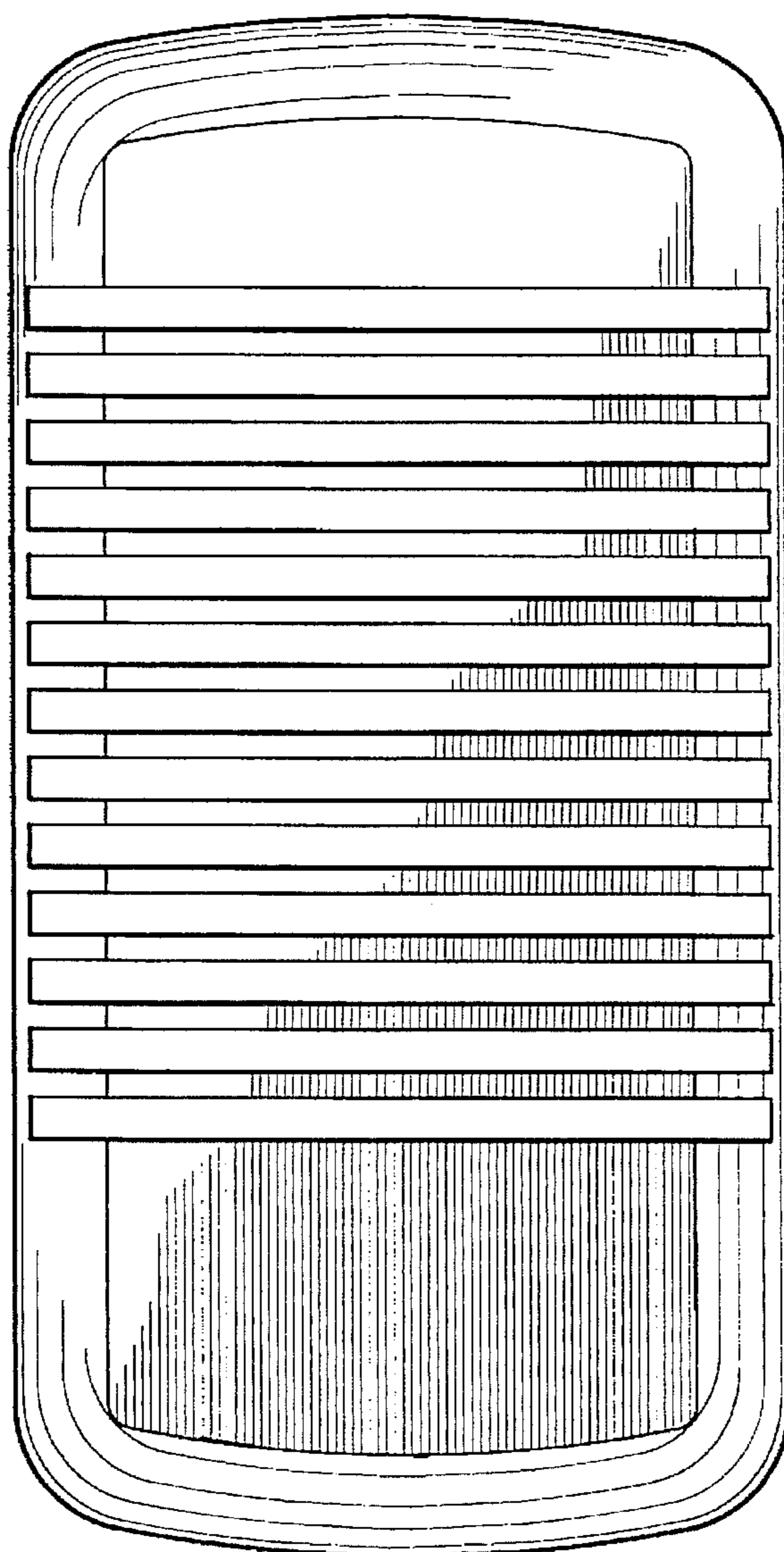

FIG. 5

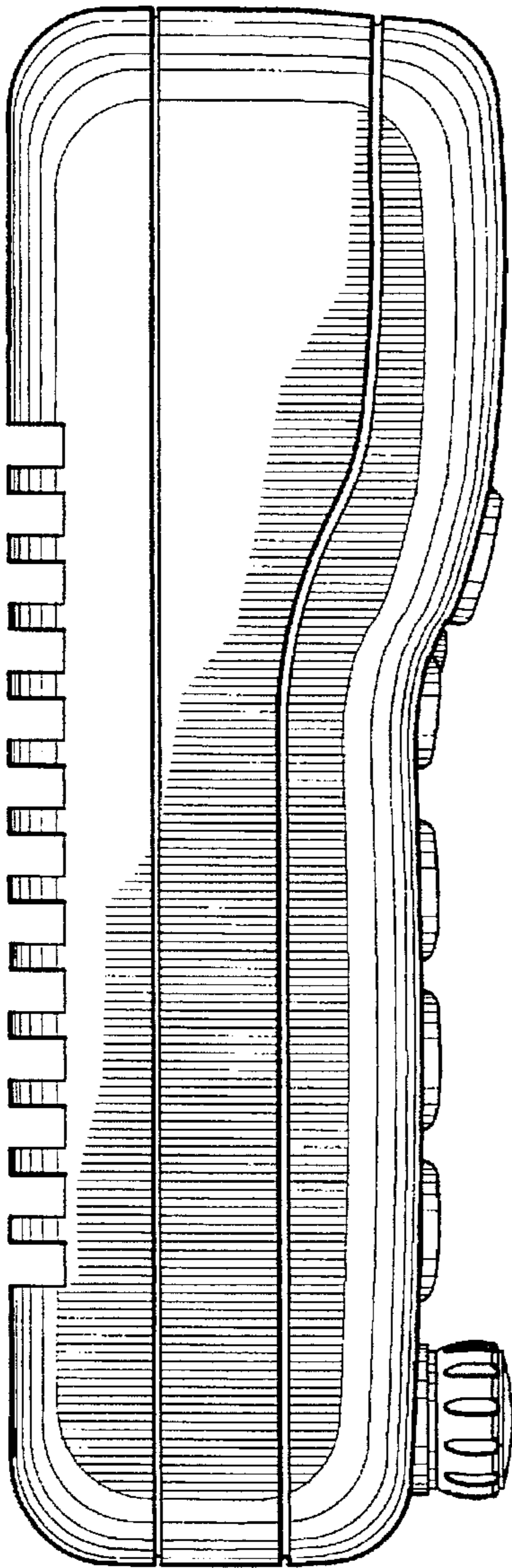

FIG. 6

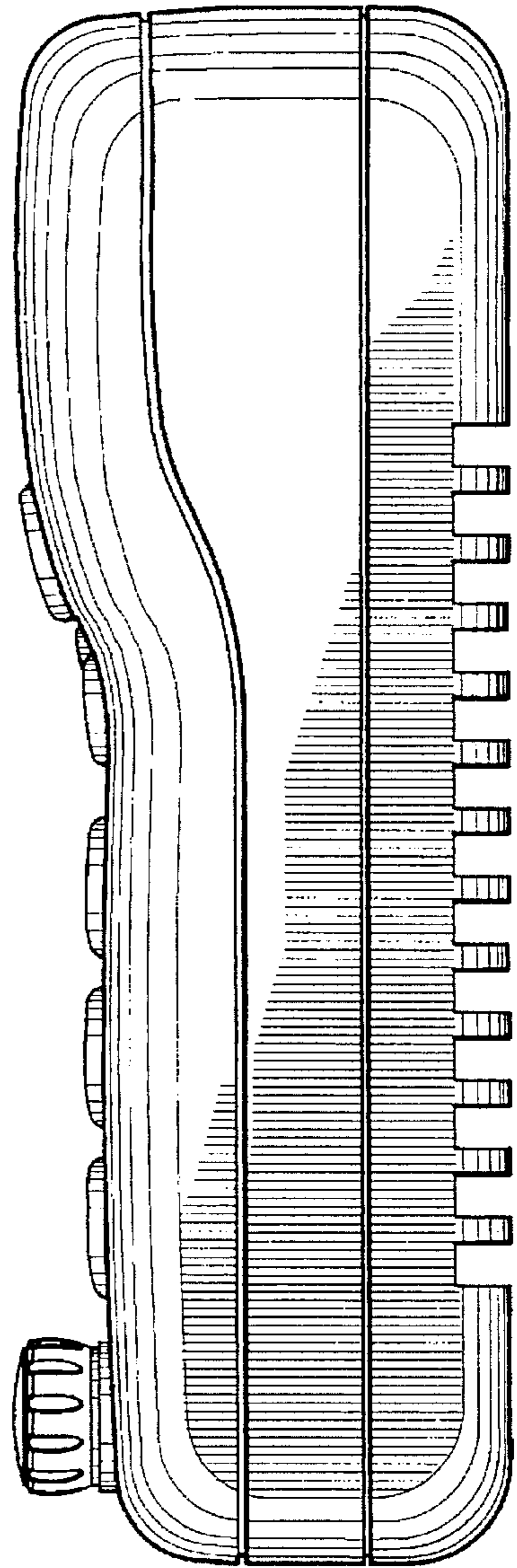

FIG. 7

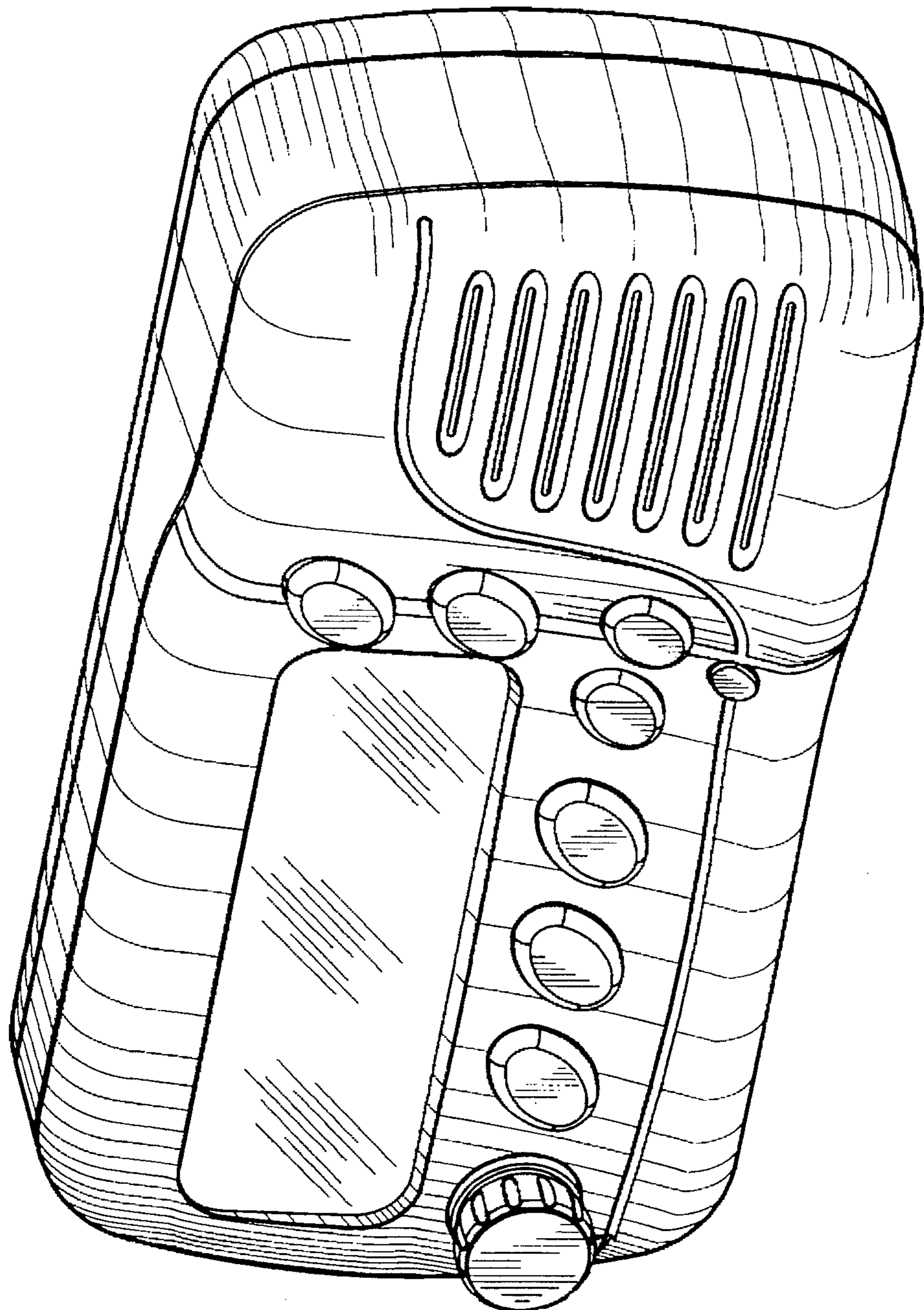

FIG. 9

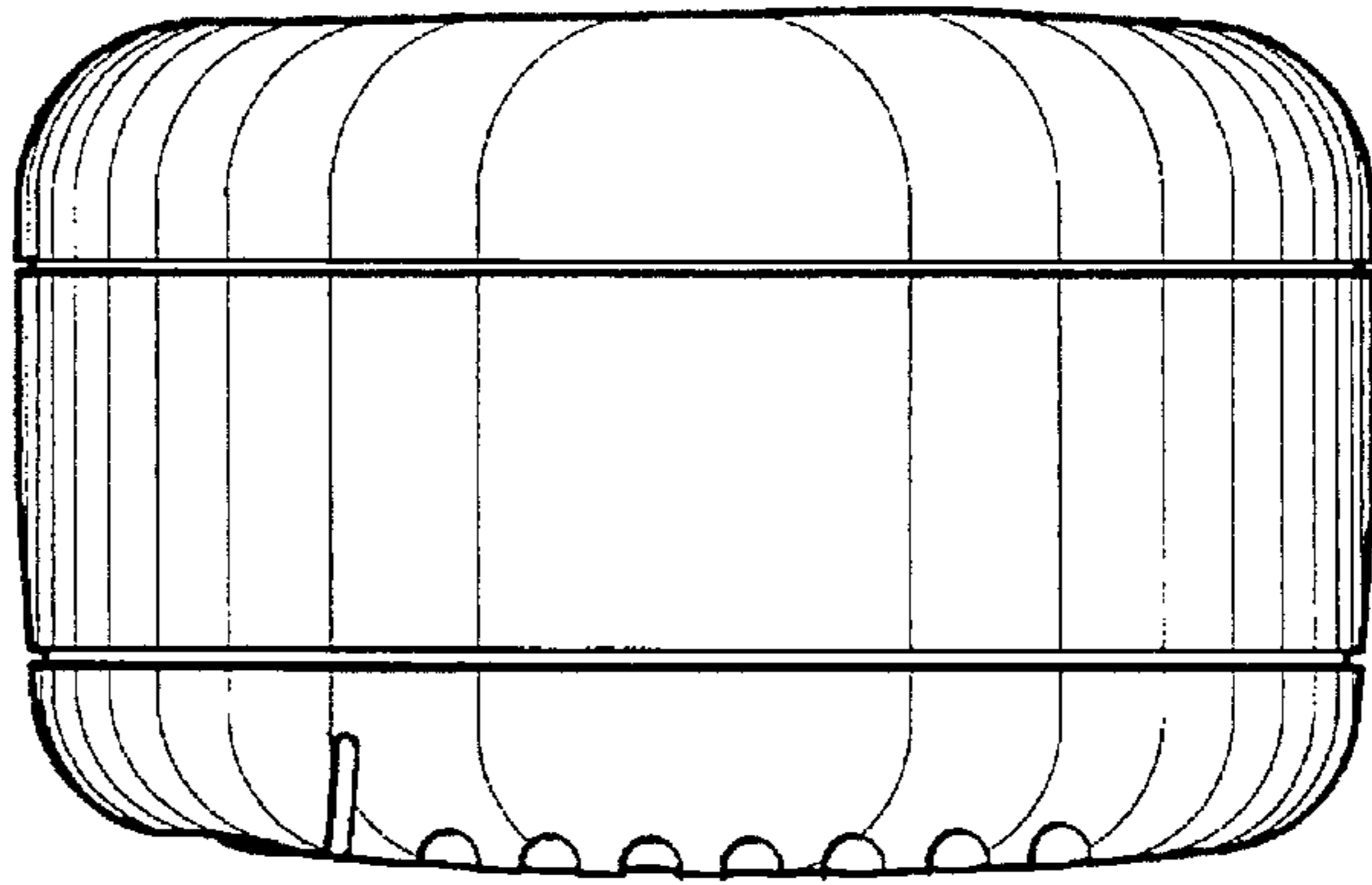

FIG. 8

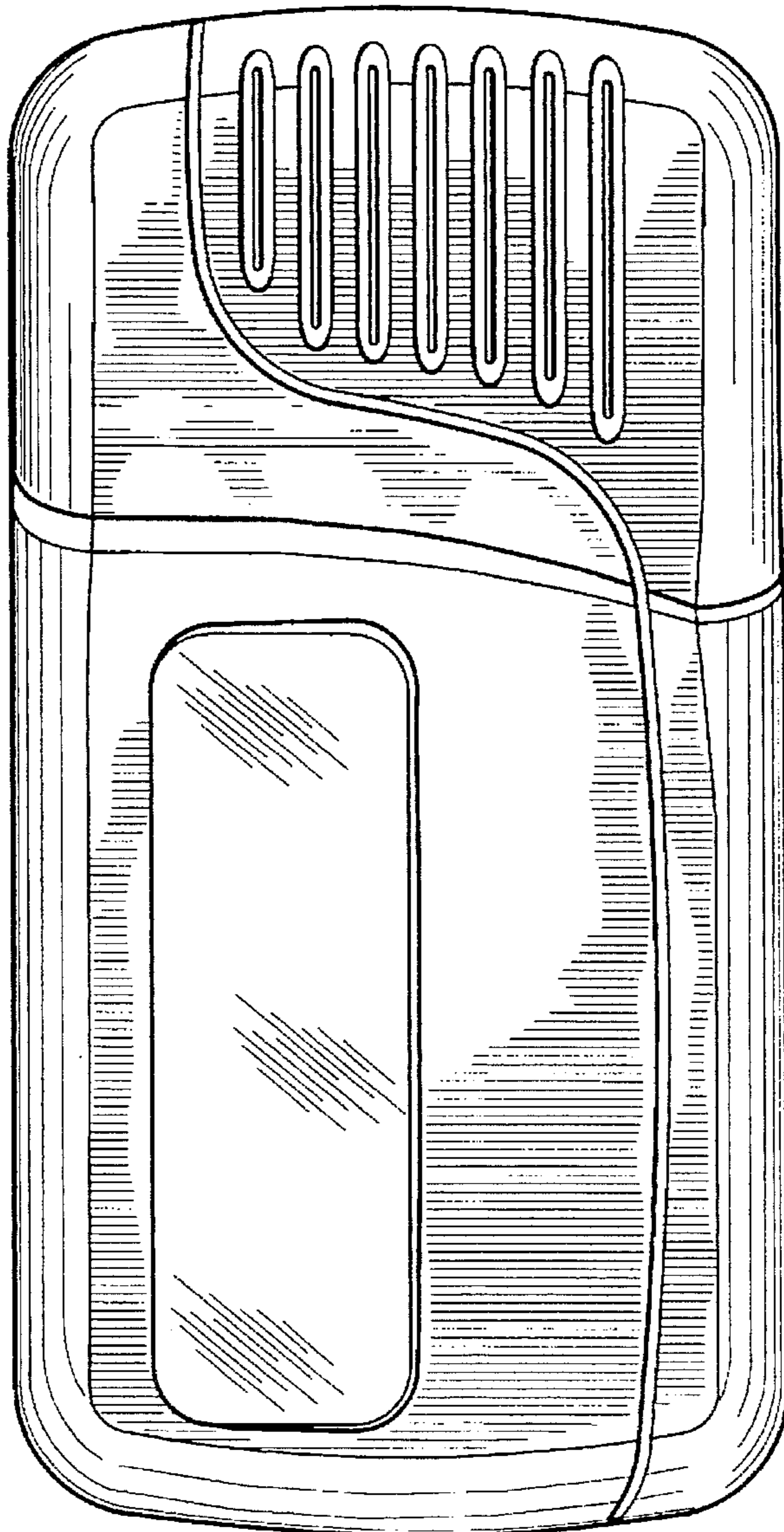

FIG. 11

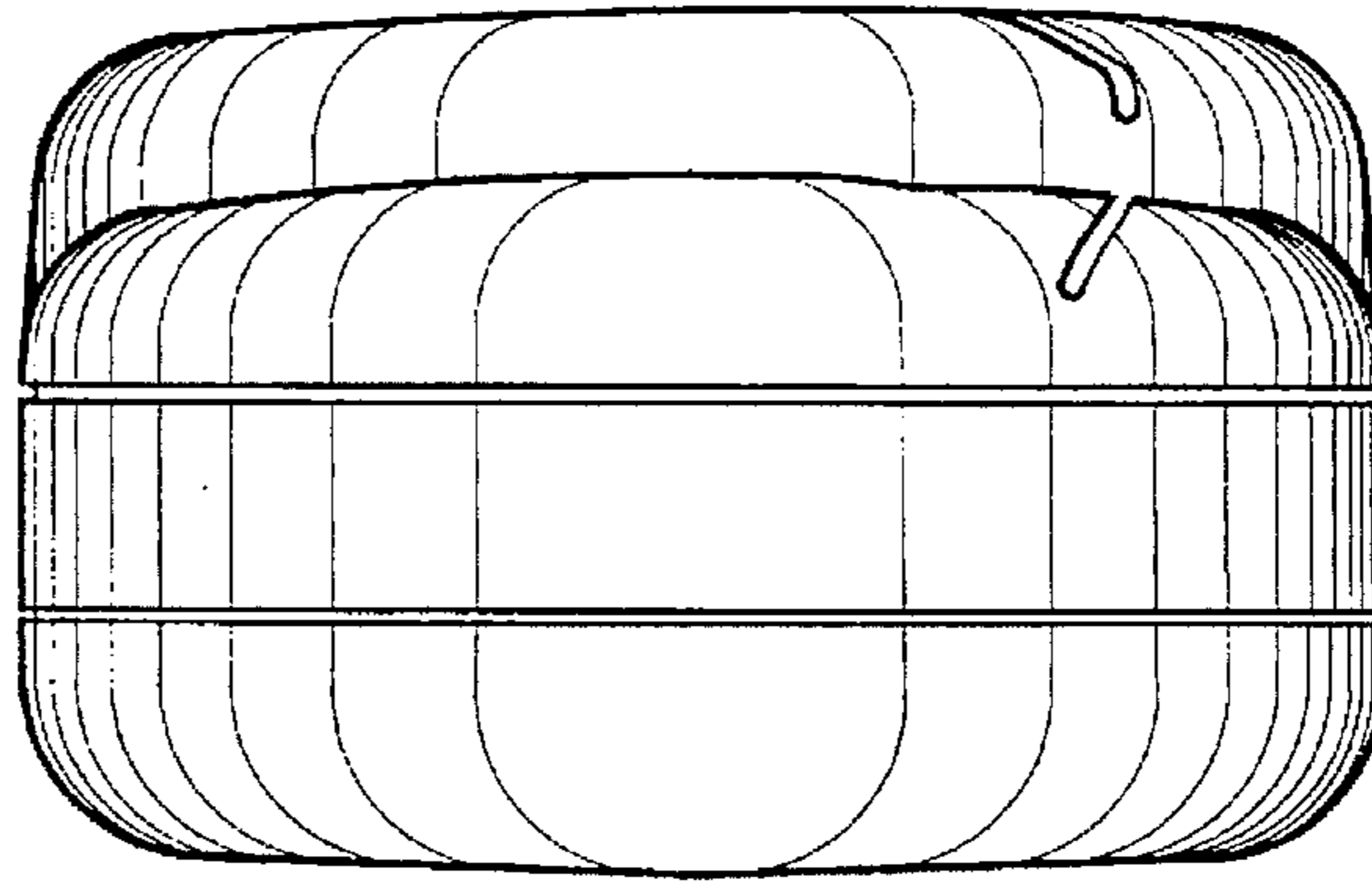

FIG. 10

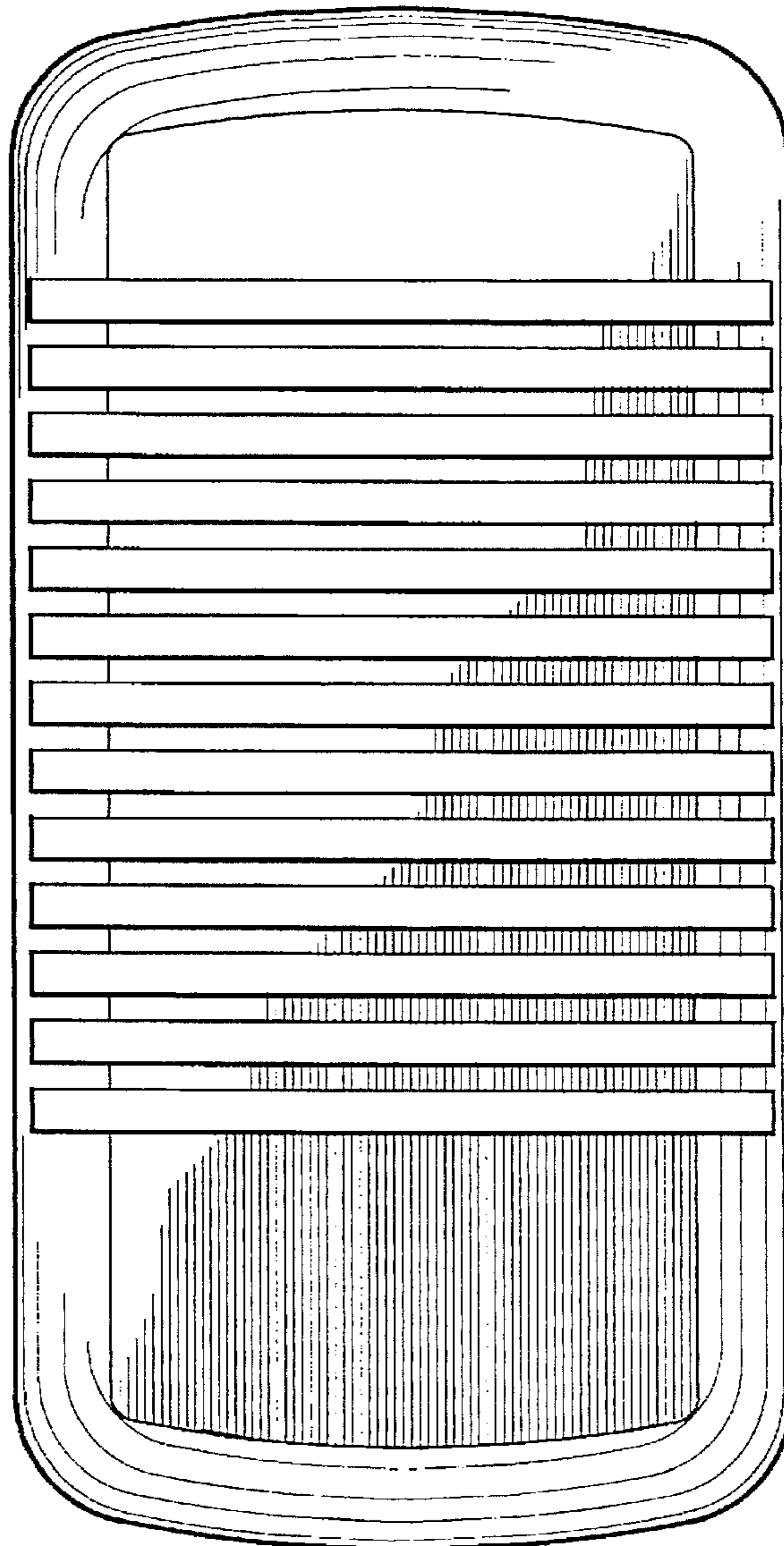

FIG. 12

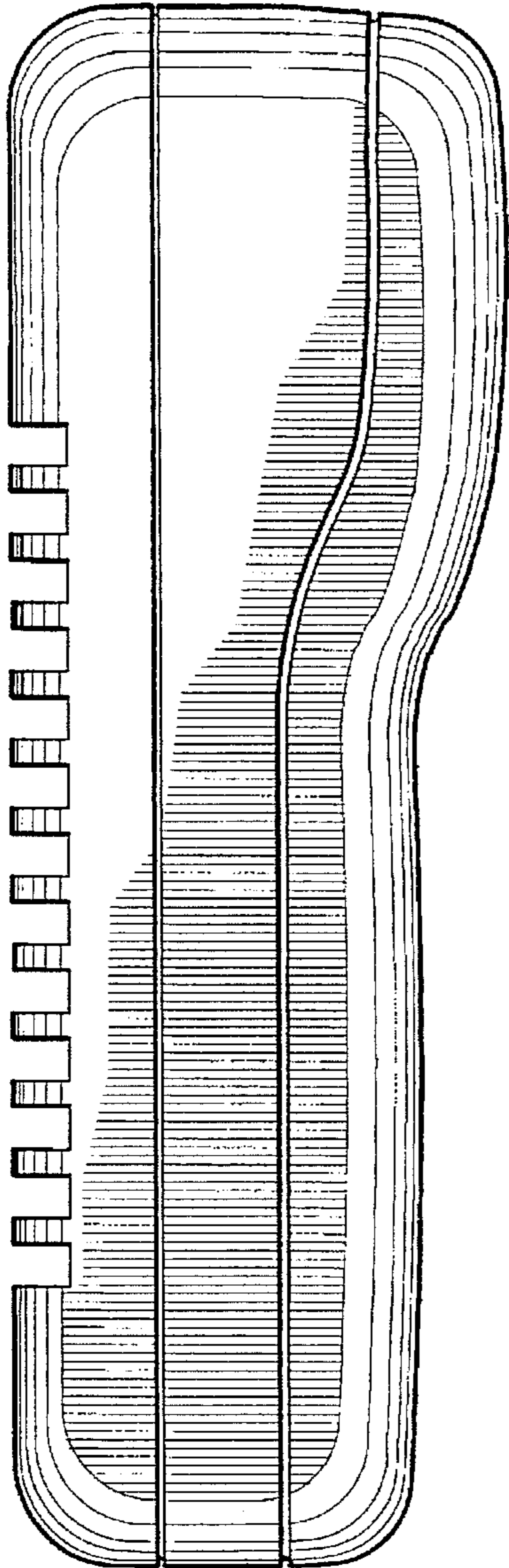

FIG. 13

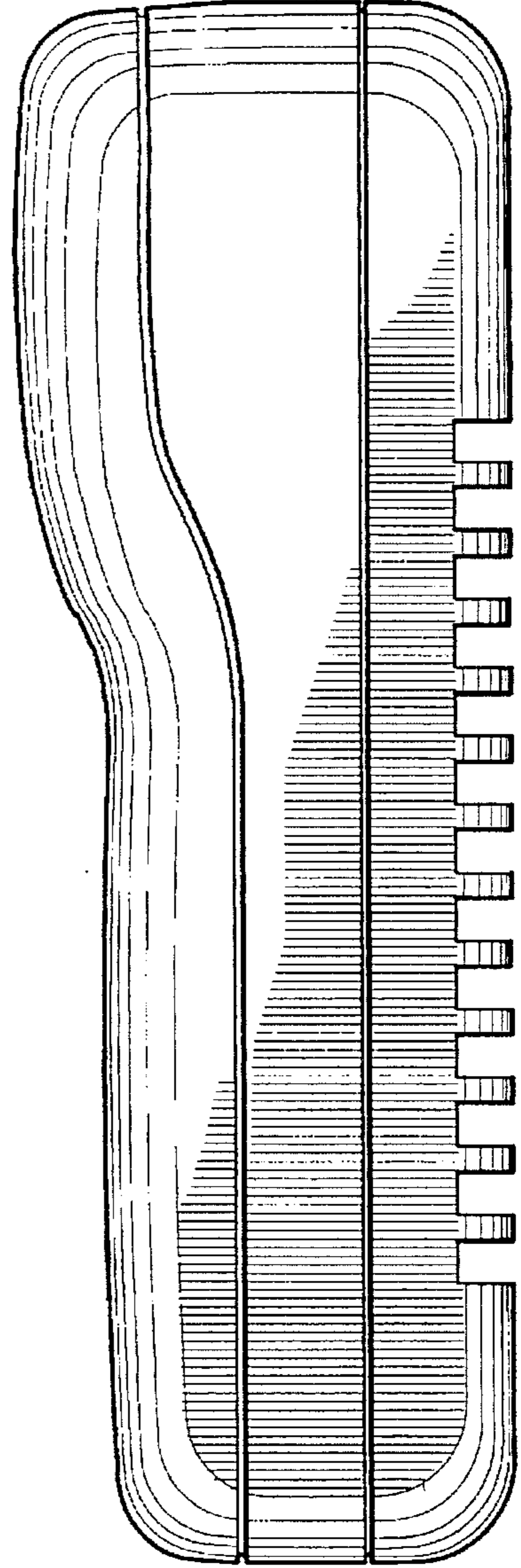

FIG. 14

