



US00D381658S

United States Patent [19]

Ito et al.

[11] Patent Number: **Des. 381,658**

[45] Date of Patent: ****Jul. 29, 1997**

[54] **COMBINED DIGITAL AUDIO DISC PLAYER, RADIO TUNER, AMPLIFIER AND TAPE RECORDER**

D. 349,288 8/1994 Ito et al. D14/168
D. 364,623 11/1995 Khadivar D14/162
D. 365,822 1/1996 Ito et al. D14/168

[75] Inventors: **Masafumi Ito; Minoru Sube; Hiroyuki Watanabe; Yukio Ikura**, all of Musashino, Japan

Primary Examiner—Ted Shooman
Assistant Examiner—Nanda Bondade
Attorney, Agent, or Firm—Michael N. Meller

[73] Assignee: **Teac Corporation**, Tokyo, Japan

[57] **CLAIM**

[**] Term: **14 Years**

The ornamental design for a combined digital audio disc player, radio tuner, amplifier and tape recorder, as shown and described.

[21] Appl. No.: **56,322**

DESCRIPTION

[22] Filed: **Jun. 26, 1996**

[30] **Foreign Application Priority Data**

Dec. 28, 1995 [JP] Japan 7-40045

[51] **LOC (6) Cl.** **14-01**

[52] **U.S. Cl.** **D14/168**

[58] **Field of Search** D14/124, 156, D14/160, 164-165, 168-171, 188, 193-195, 197-198; 455/344, 350, 351

FIG. 1 is a front view of a combined digital audio disc player, radio tuner, amplifier and tape recorder showing our new design;
FIG. 2 is a rear view thereof;
FIG. 3 is a top view thereof;
FIG. 4 is a bottom view thereof;
FIG. 5 is a right side view thereof;
FIG. 6 is a left side view thereof; and,
FIG. 7 is a perspective view of the combined digital audio disc player, radio tuner, amplifier and tape recorder of the present invention.

[56] **References Cited**

U.S. PATENT DOCUMENTS

D. 343,393 1/1994 Ito et al. D14/163 X

1 Claim, 4 Drawing Sheets

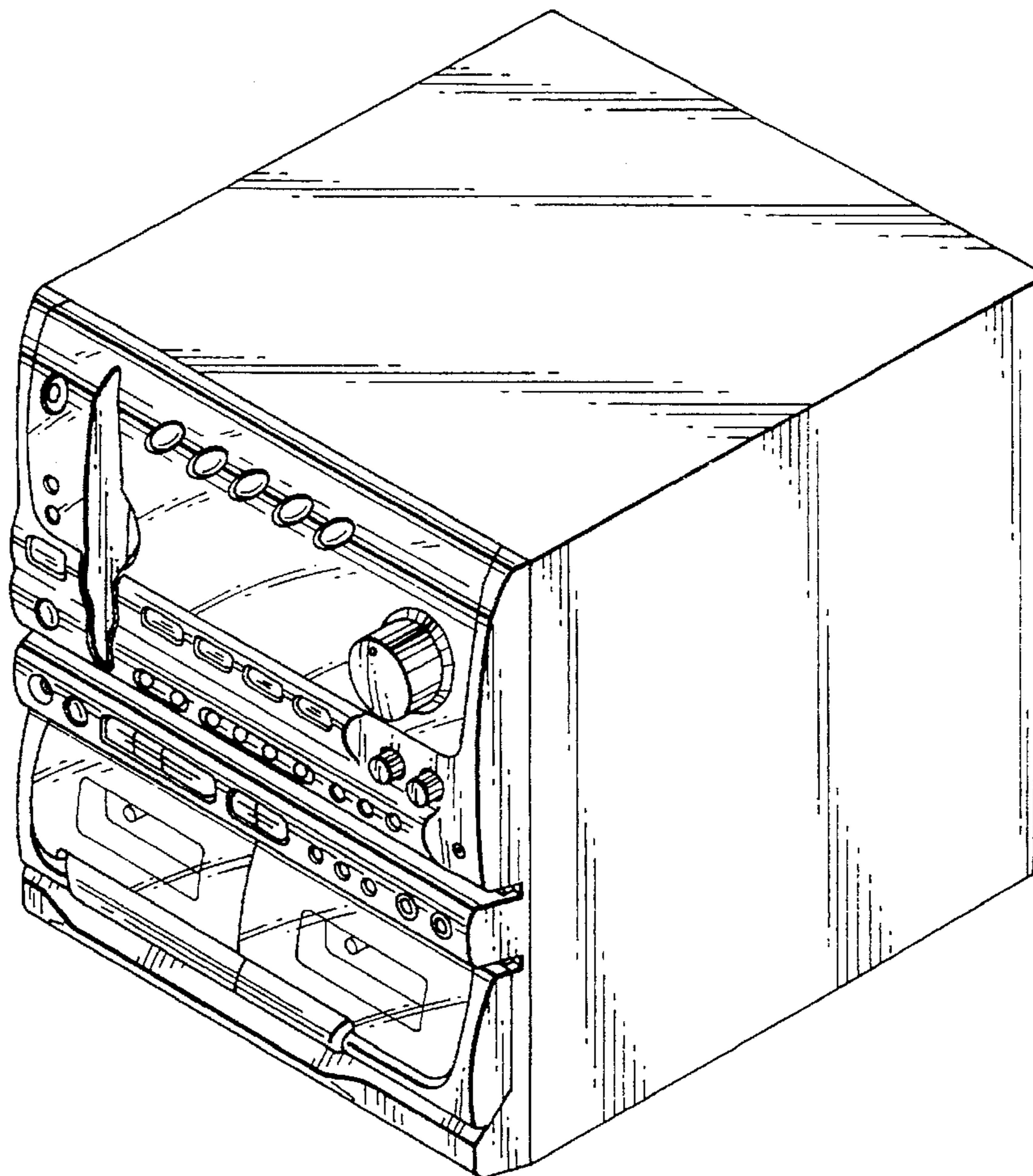

FIG. 1

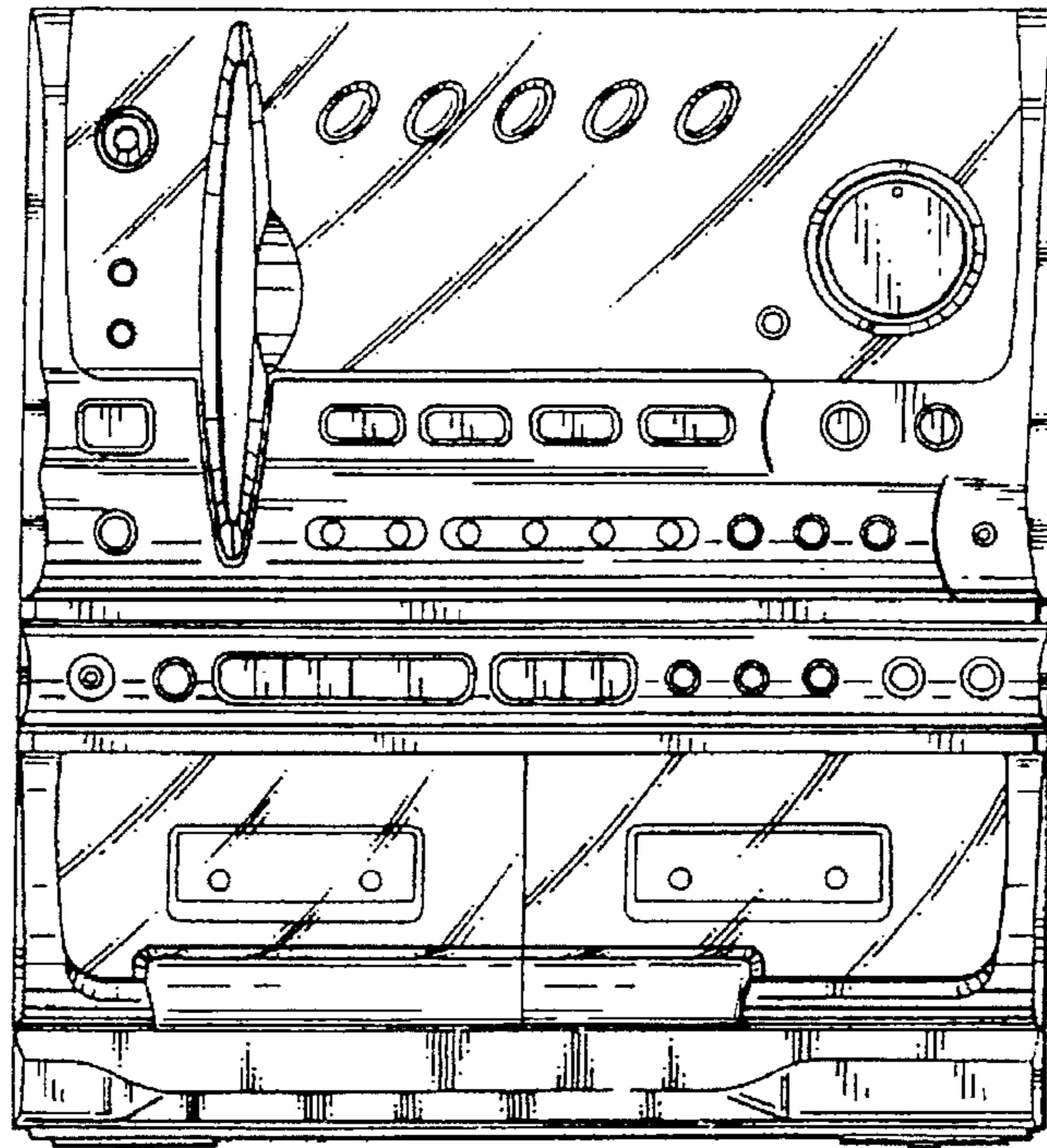

FIG. 2

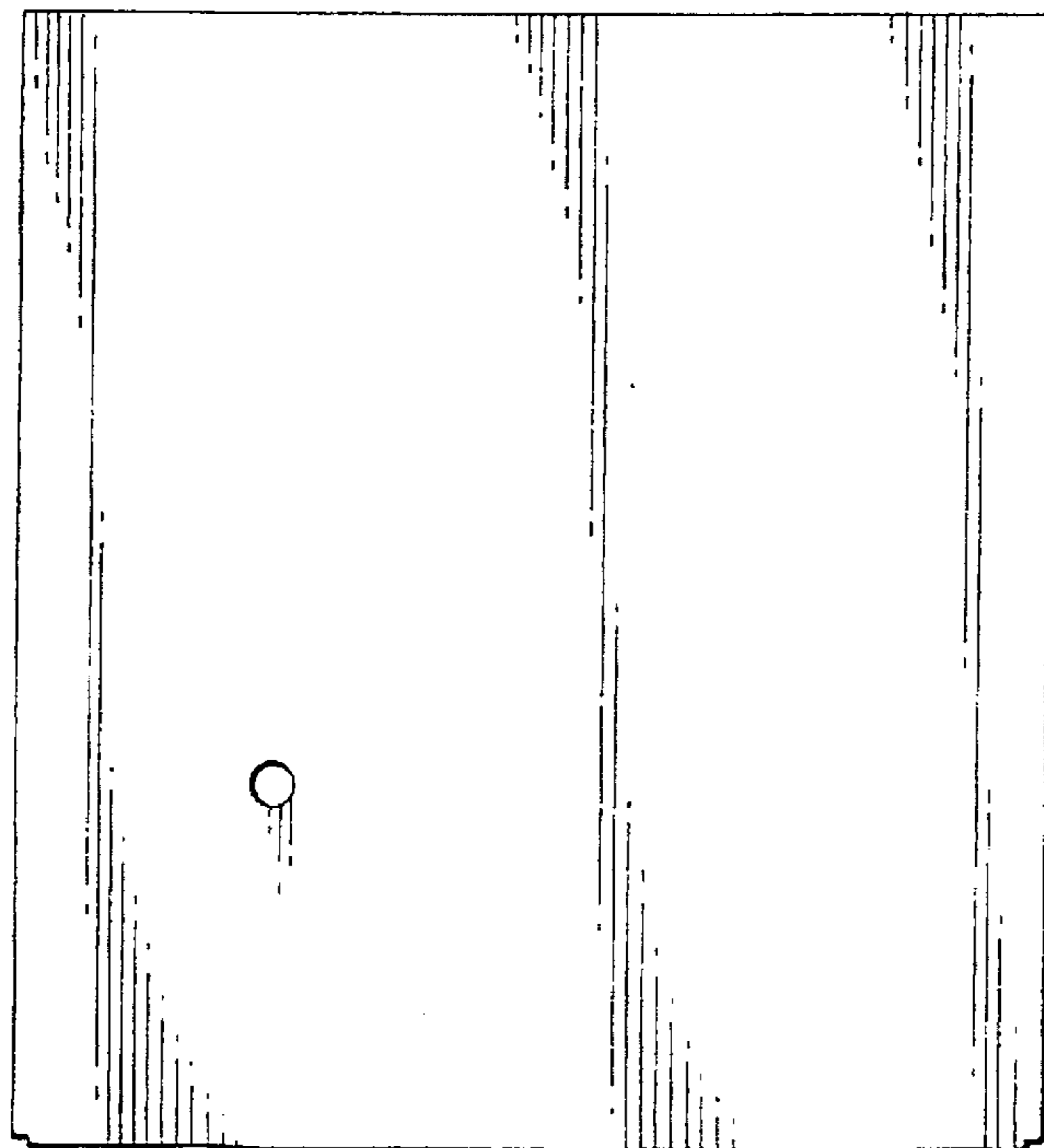

FIG. 3

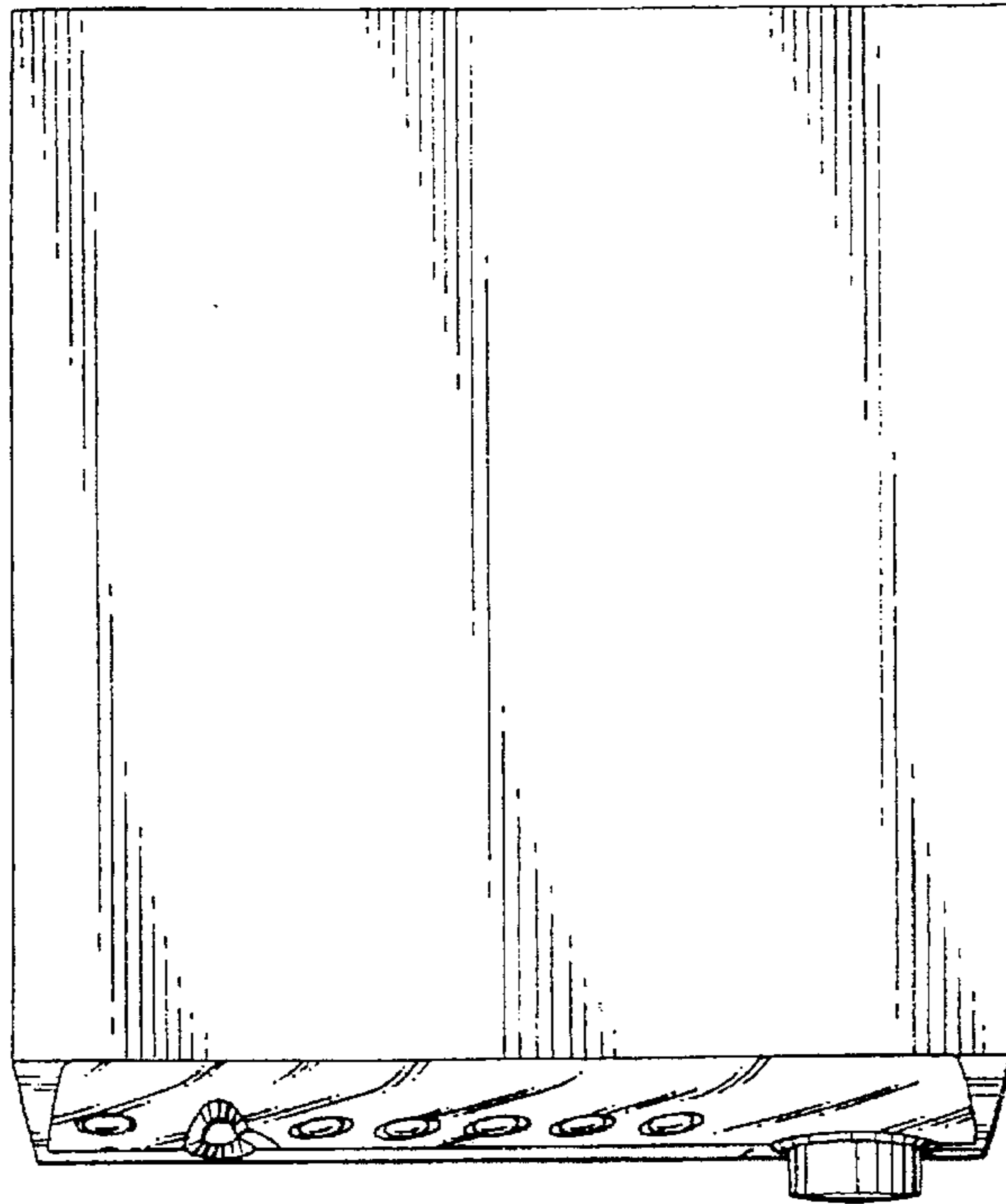

FIG. 4

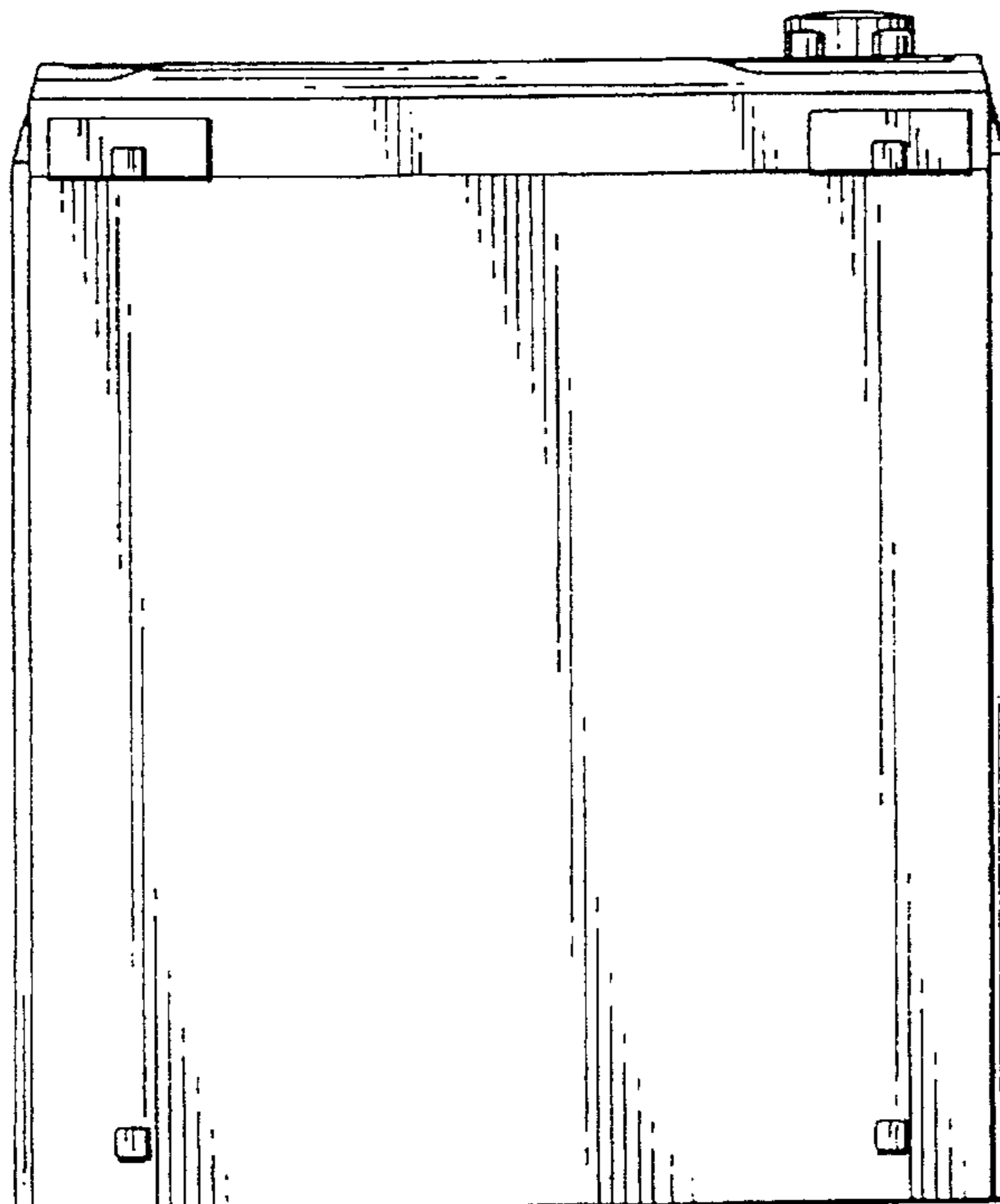

FIG. 5

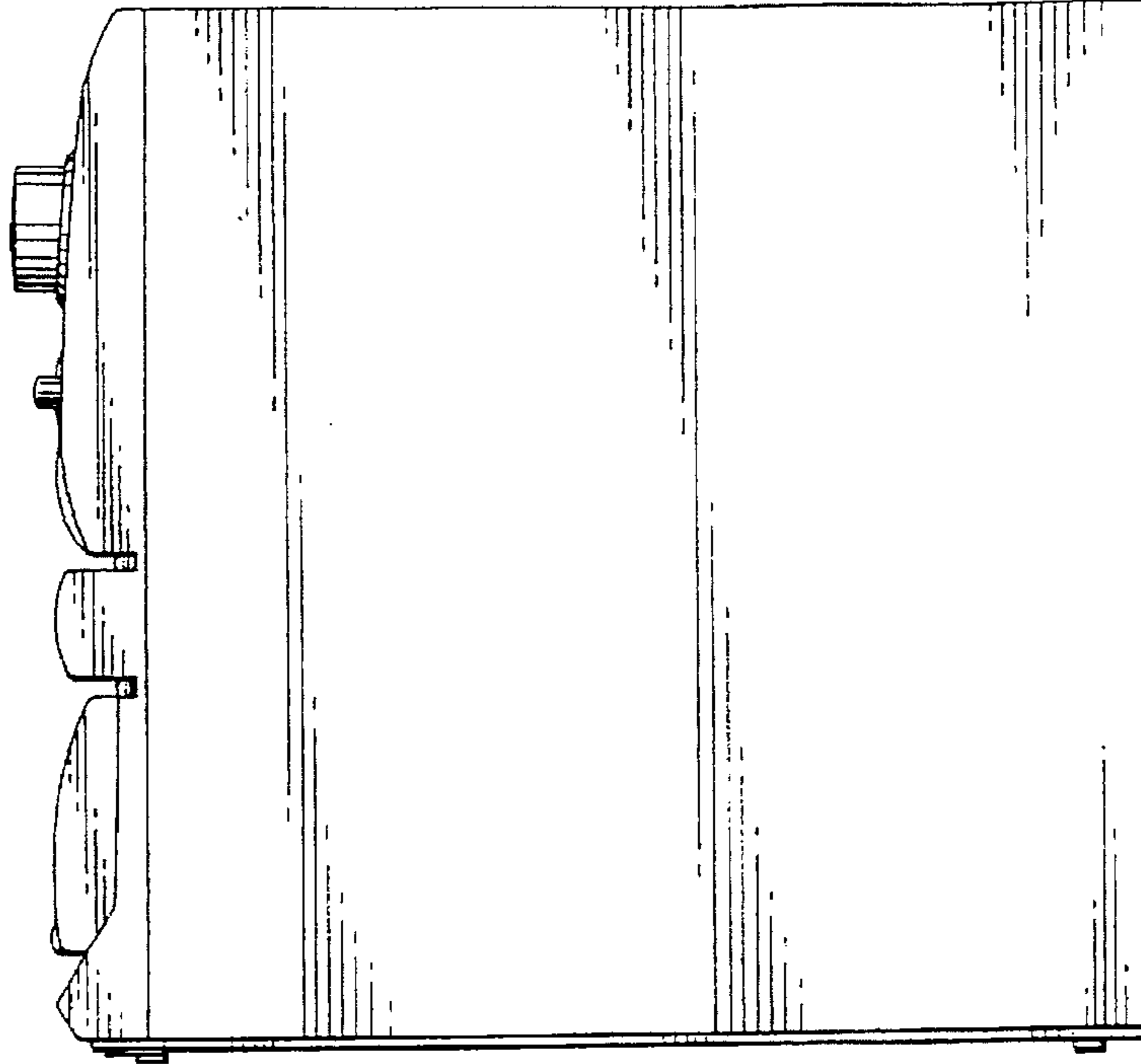

FIG. 6

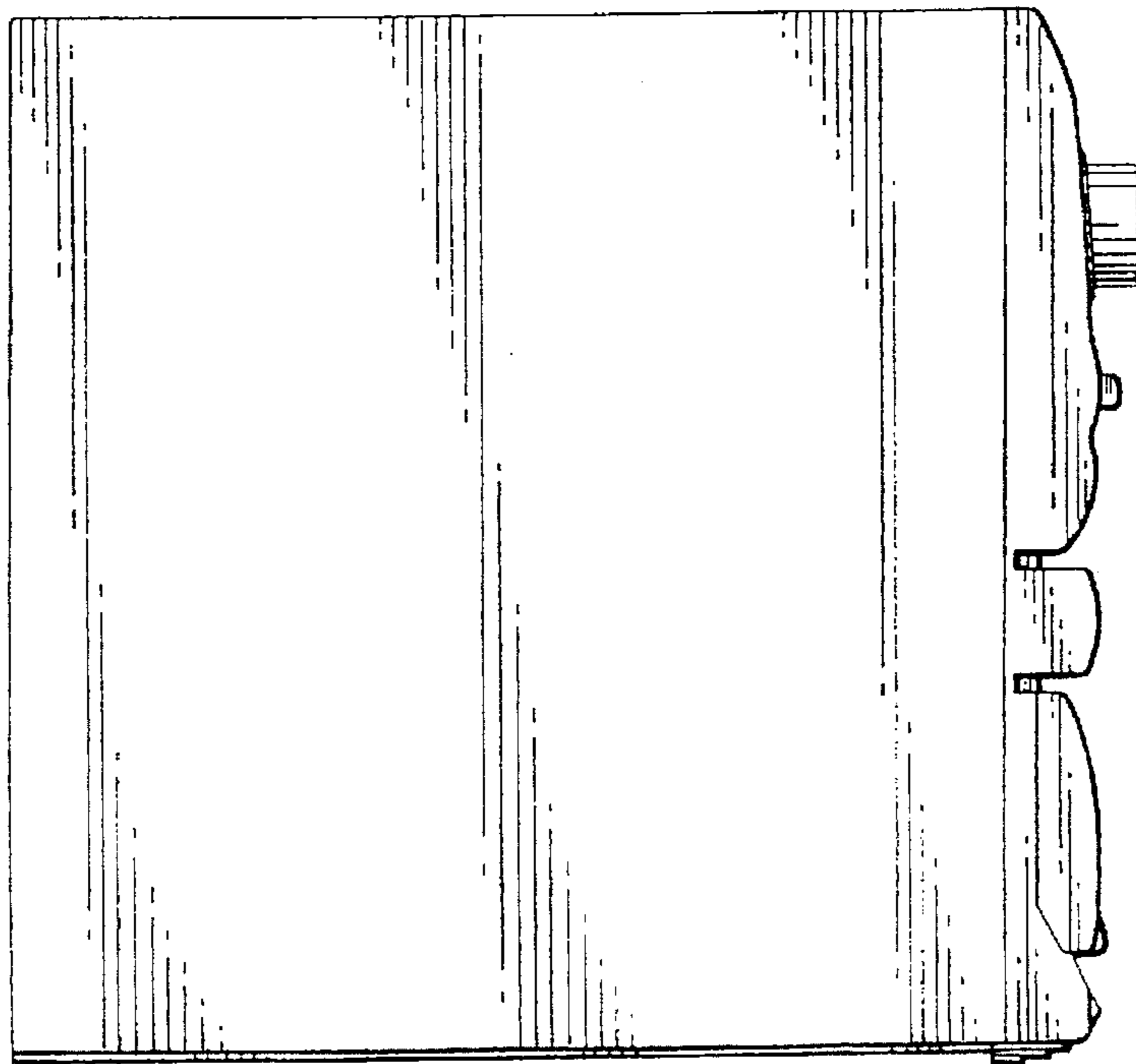

FIG. 7

