



US00D381586S

United States Patent [19] Scholpp

[11] Patent Number: **Des. 381,586**

[45] Date of Patent: ****Jul. 29, 1997**

[54] WATCH

D. 237,815 11/1975 Bulgari D10/32 X
D. 269,546 6/1983 Rogers et al. D10/30 X

[75] Inventor: **Werner Scholpp**, Oberriexingen,
Germany

FOREIGN PATENT DOCUMENTS

[73] Assignee: **Rado Uhren AG (Rado Watch Co. Ltd.) (Montres Rado SA)**, Lengnau,
Switzerland

0648177 3/1985 Switzerland 368/282

[**] Term: **14 Years**

Primary Examiner—Janice E. Seeger
Attorney, Agent, or Firm—McGlew and Tuttle

[21] Appl. No.: **45,290**

[57] CLAIM

The ornamental design for a watch, as shown and described.

[22] Filed: **Oct. 16, 1995**

DESCRIPTION

[30] Foreign Application Priority Data

May 24, 1995 [CH] Switzerland DM/033 079

FIG. 1 is a top view of my new watch design, showing the wristwatch disposed in a position it would be when worn;
FIG. 2 is a bottom view thereof;
FIG. 3 is a right side view thereof;
FIG. 4 is a right side view thereof;
FIG. 5 is a right top perspective view thereof;
FIG. 6 is a top view of my new watch design disposed in a flattened state;
FIG. 7 is a bottom view thereof;
FIG. 8 is a right side view thereof;
FIG. 9 is a left side view thereof; and,
FIG. 10 is a perspective view thereof.

[51] LOC (6) Cl. **10-02**

[52] U.S. Cl. **D10/32; D10/39**

[58] Field of Search D10/30, 32, 38,
D10/39, 128; 368/280-282, 285, 276, 277,
294; D11/3-4, 12, 14, 19-24; 63/1.1, 3,
5.1, 11

[56] References Cited

U.S. PATENT DOCUMENTS

D. 186,818 12/1959 Gale D10/38 X

1 Claim, 5 Drawing Sheets

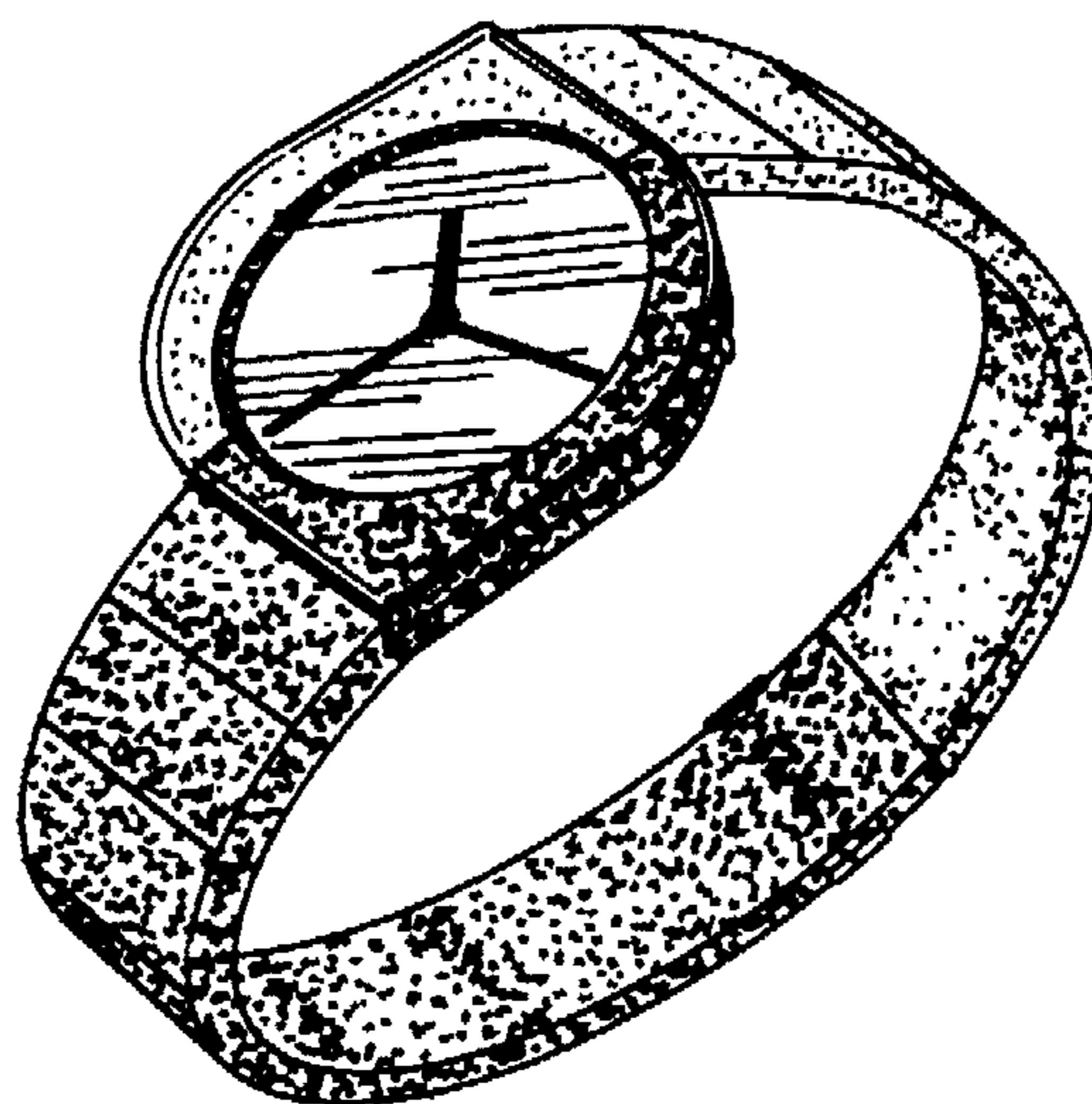

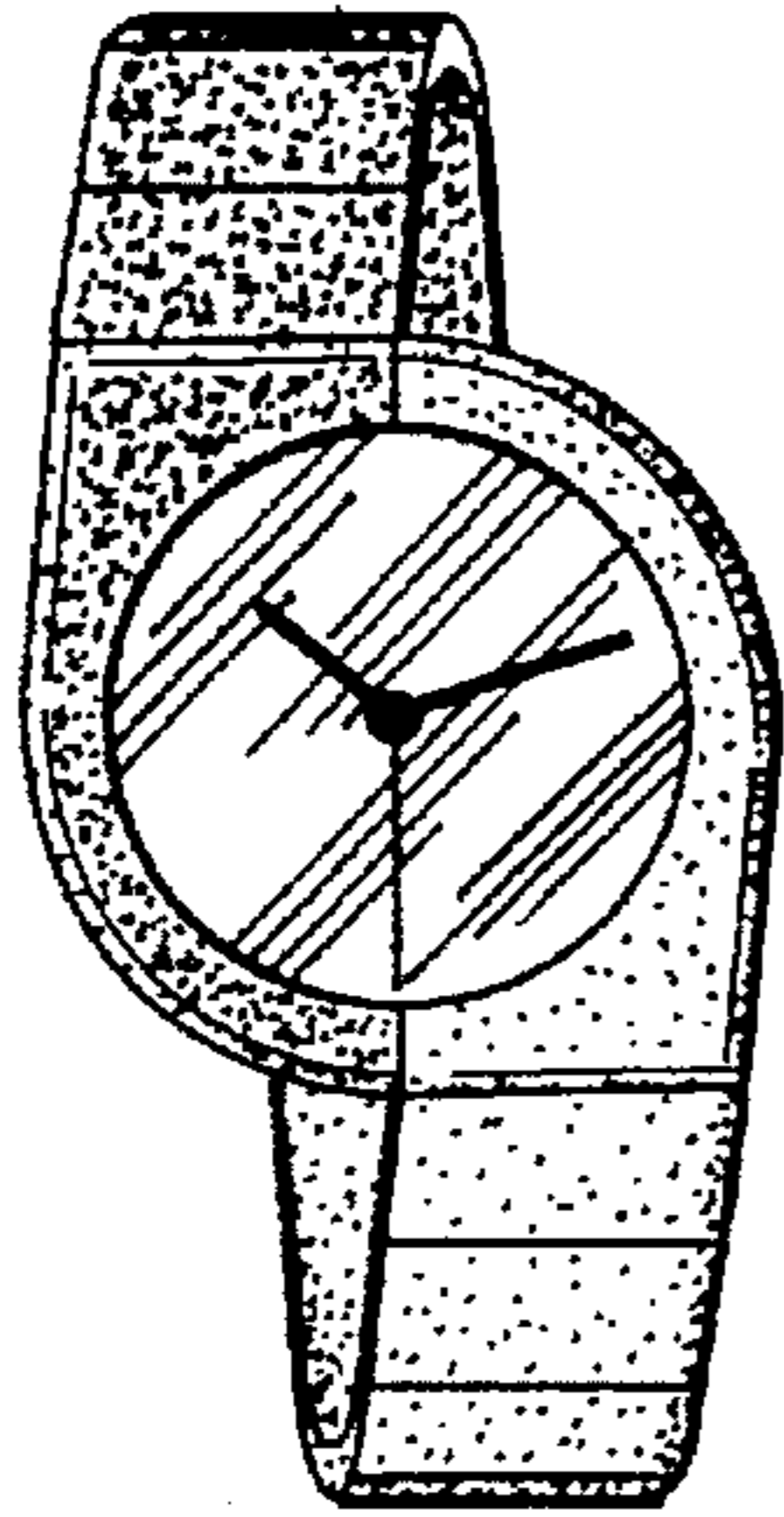

Fig. 1

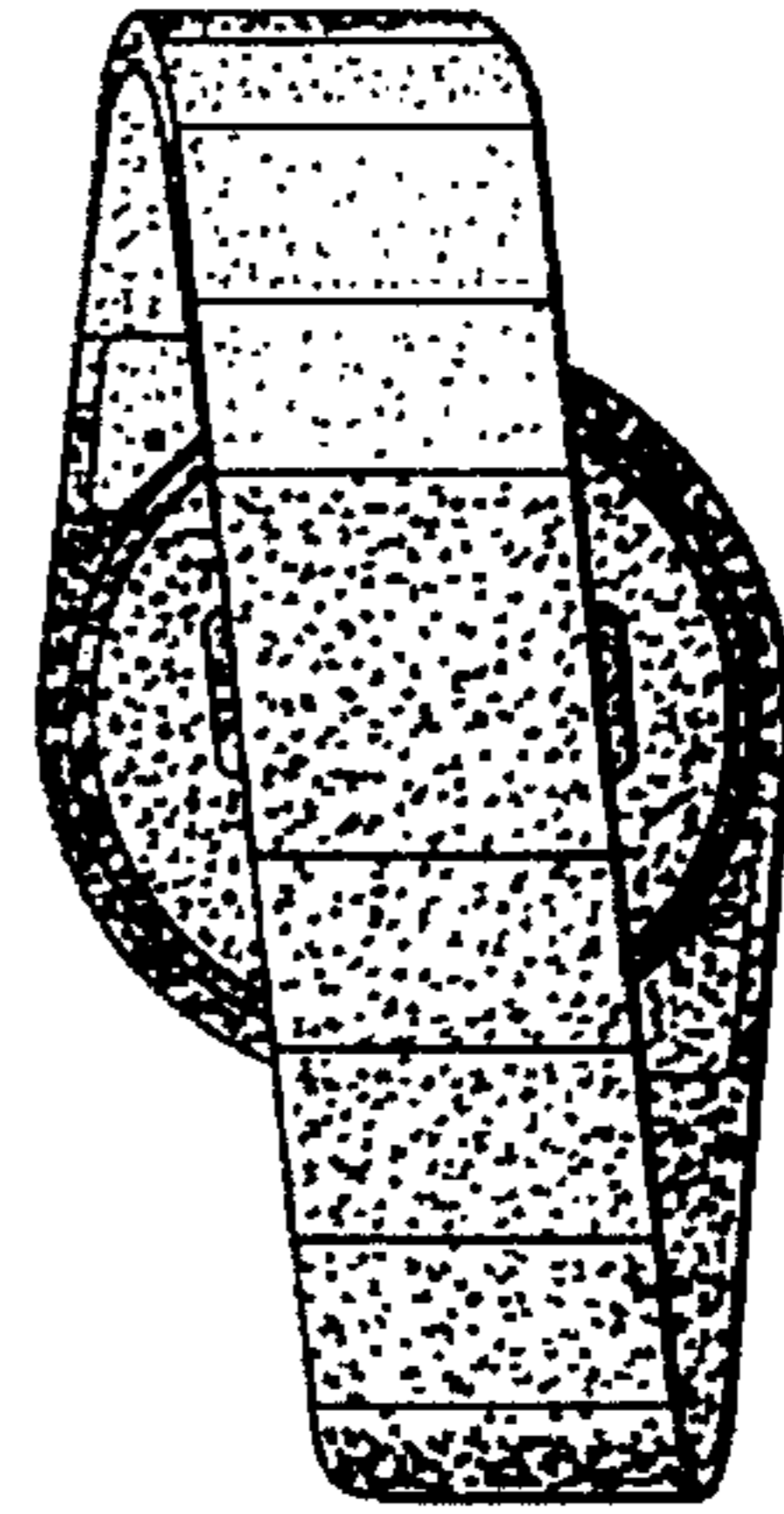

Fig. 2

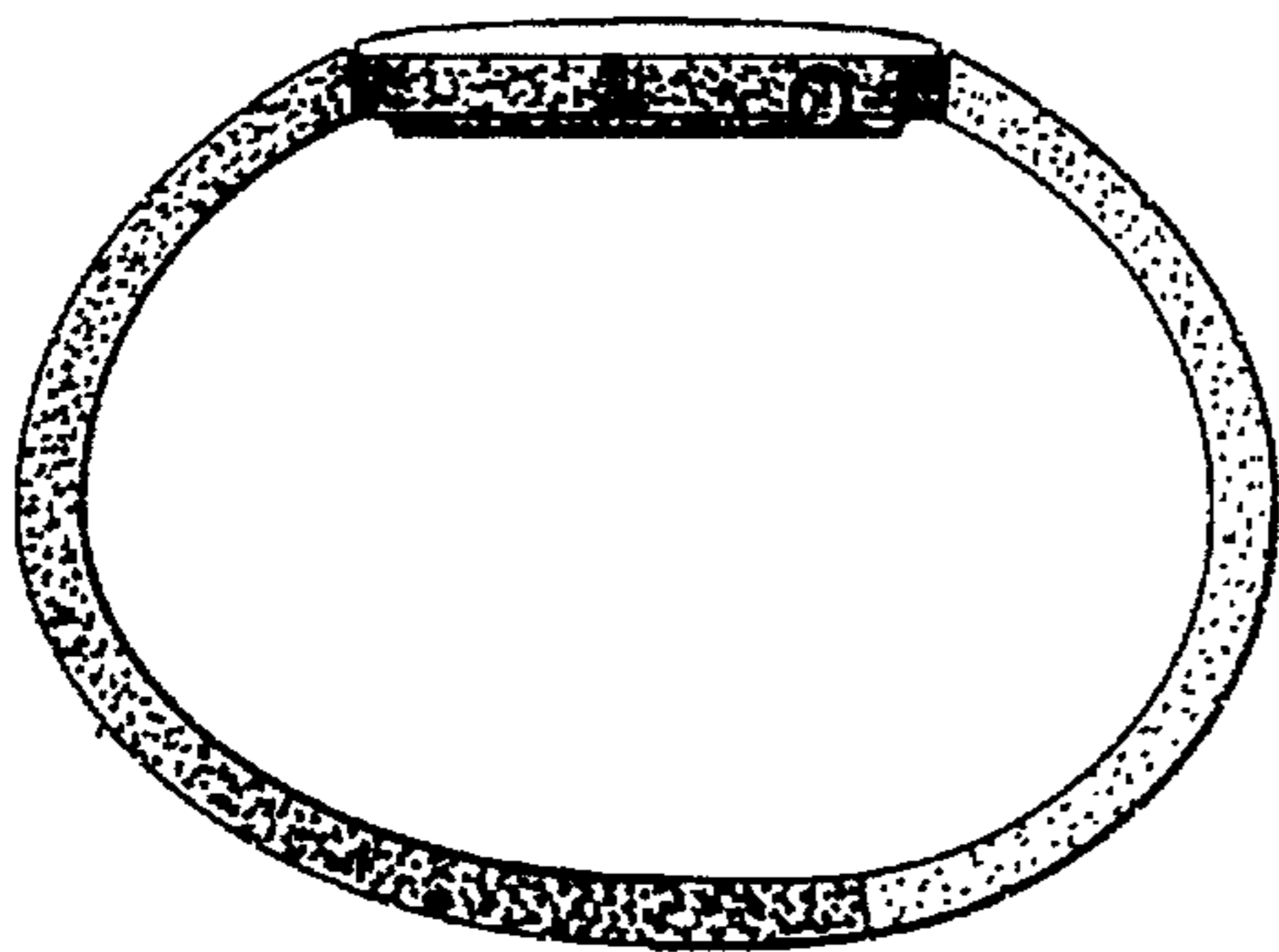

Fig. 3

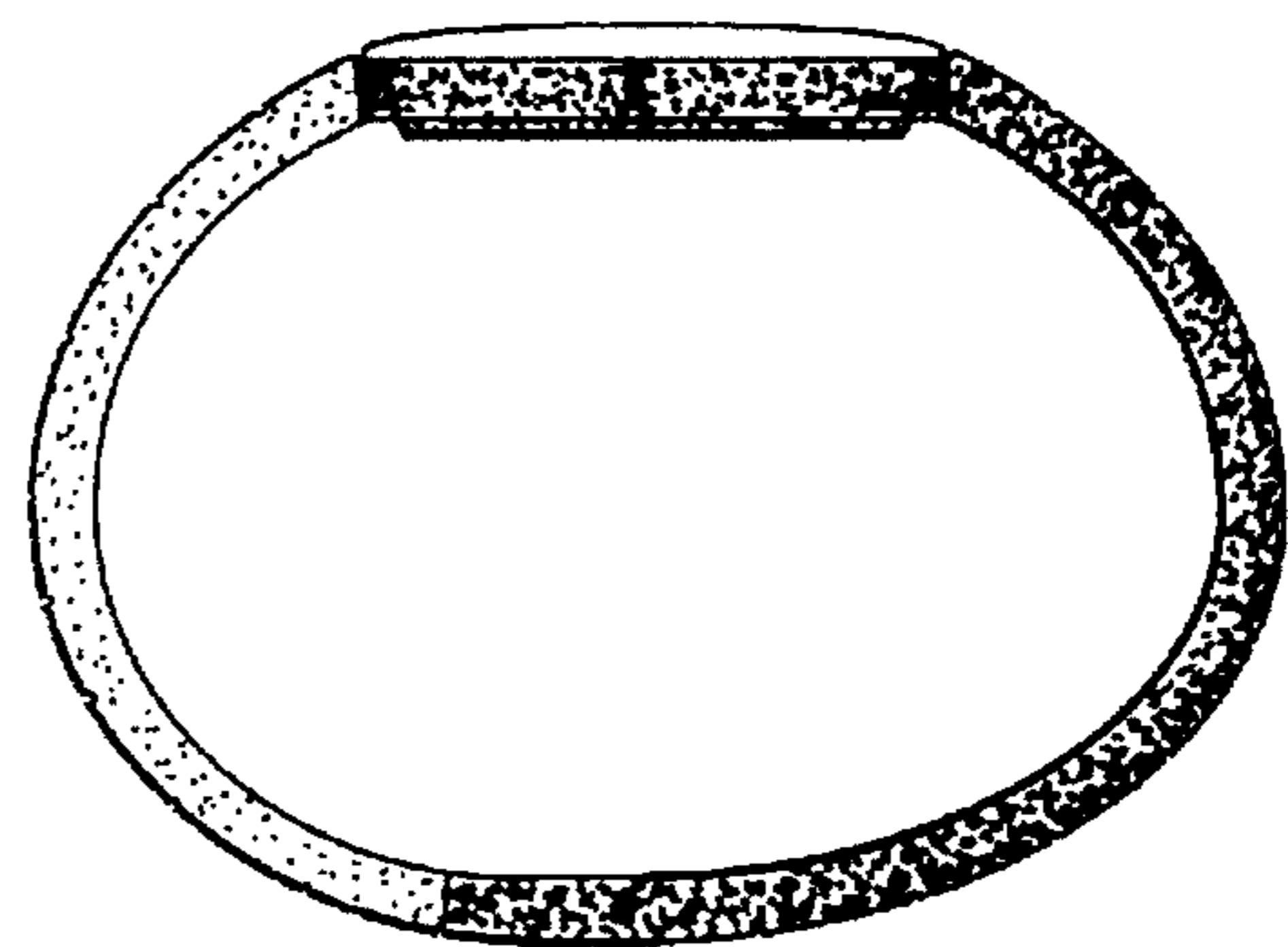

Fig. 4

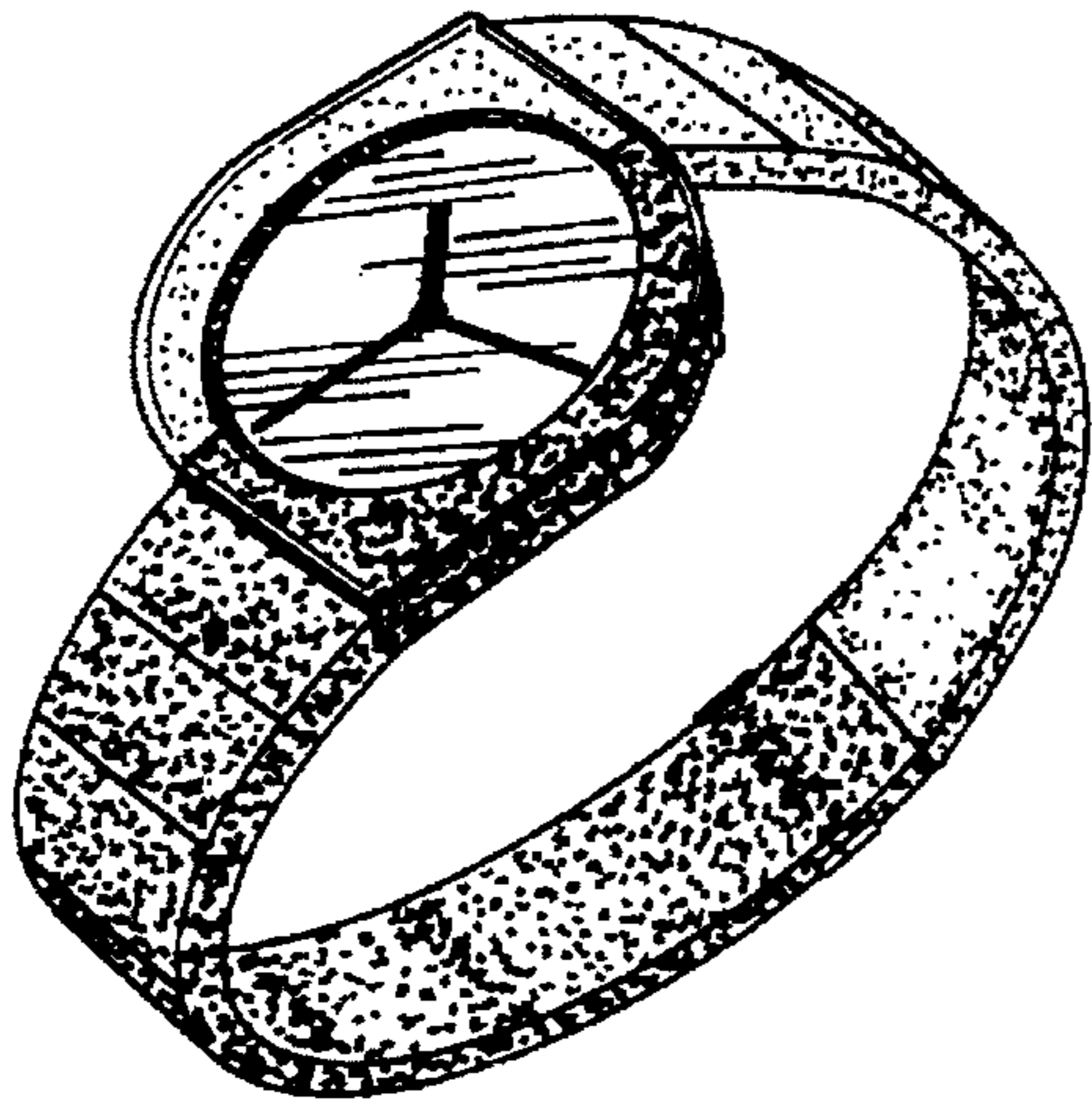

Fig. 5

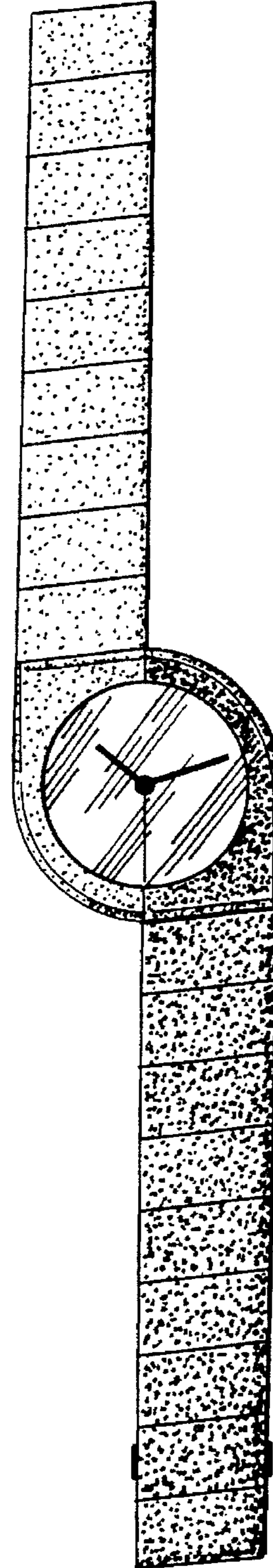

Fig. 6

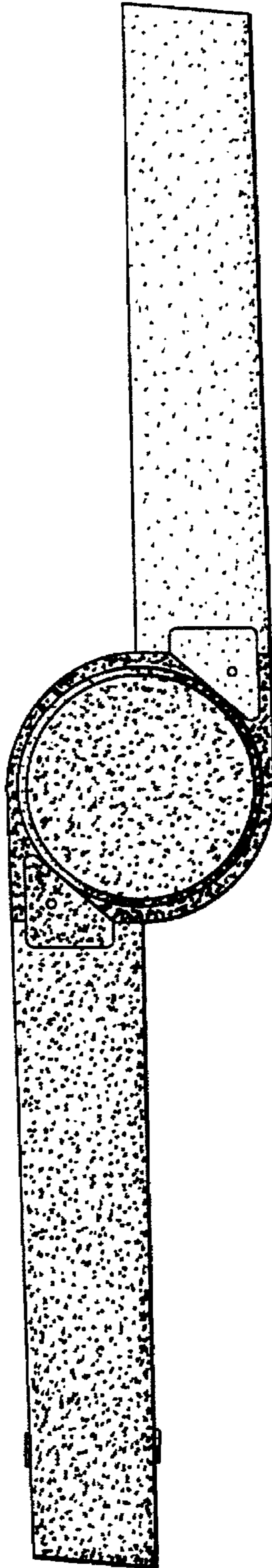

Fig. 7

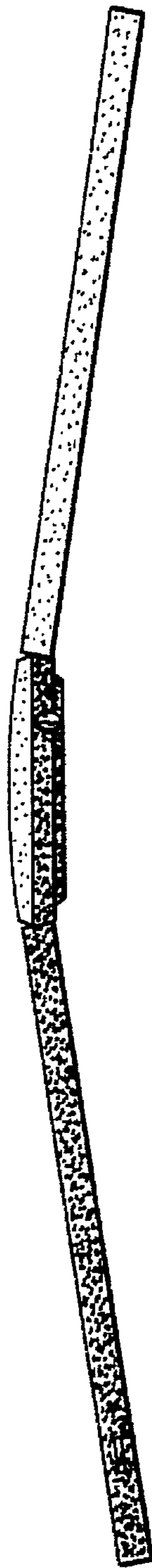

Fig. 8

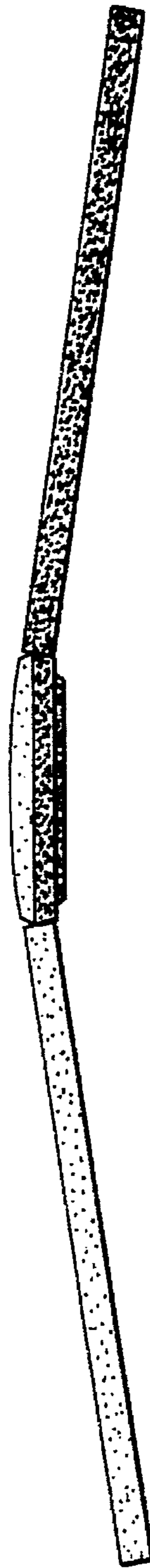

Fig. 9

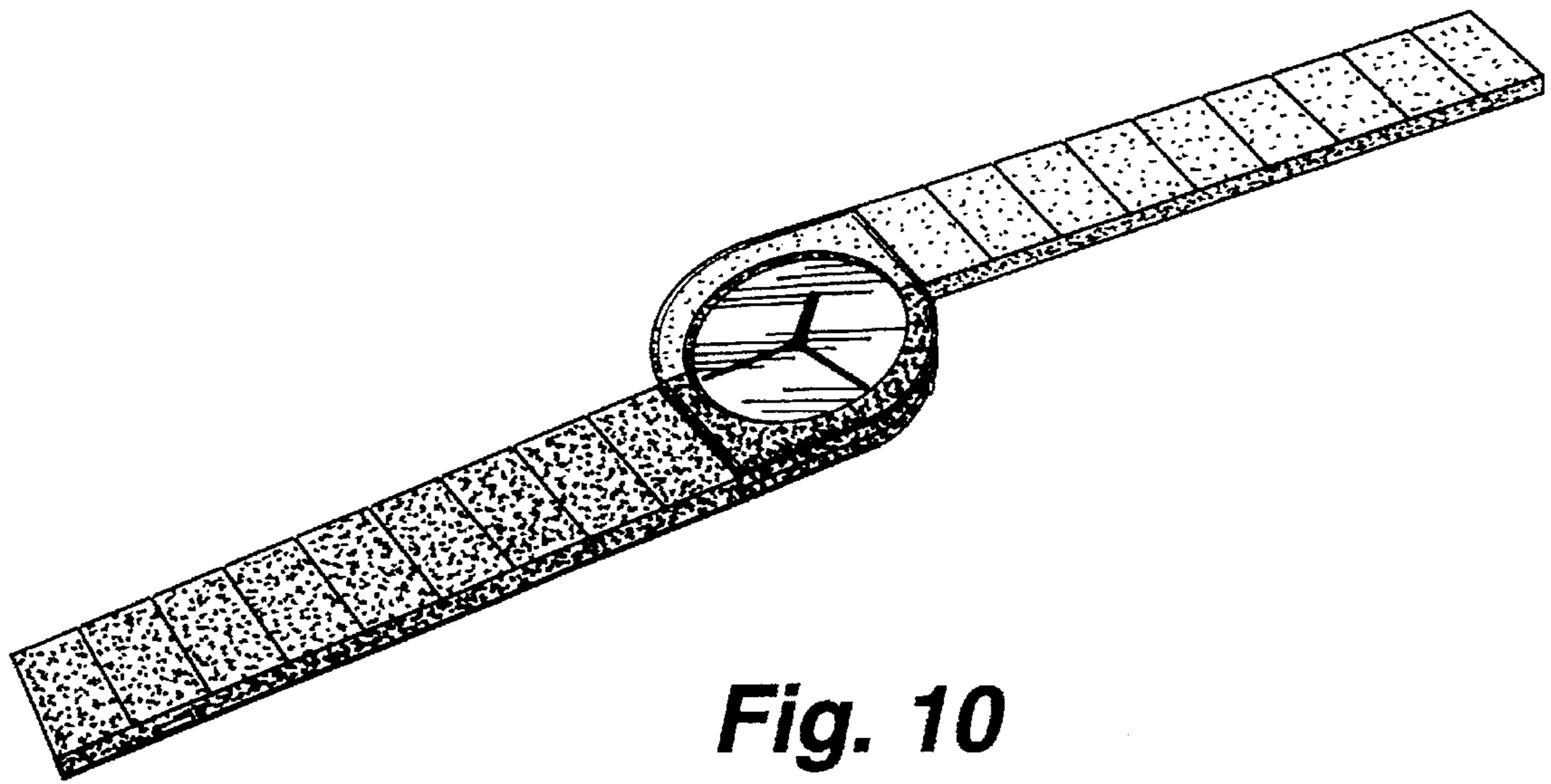

Fig. 10