

US00D381565S

United States Patent [19]
Hibberd

[11] **Patent Number: Des. 381,565**
[45] **Date of Patent: **Jul. 29, 1997**

[54] **GARDEN SHEARS**

FOREIGN PATENT DOCUMENTS

[75] Inventor: **George Henry Hibberd**, Sheffield, England

983482 2/1978 United Kingdom .

[73] Assignee: **James Nell Holdings Limited**, Sheffield, England

Primary Examiner—Holly Baynham
Attorney, Agent, or Firm—Trexler, Bushnell, Giangiorgi & Blackstone, Ltd.

[**] Term: **14 Years**

[57] **CLAIM**

[21] Appl. No.: **41,488**

The ornamental design for a garden shears, as shown and described.

[22] Filed: **Jul. 17, 1995**

DESCRIPTION

[30] **Foreign Application Priority Data**

Jan. 19, 1995 [GB] United Kingdom GB 2044582

[51] LOC (6) Cl. **08-01**

[52] U.S. Cl. **D8/5**

[58] Field of Search D8/4, 5; 30/257, 30/251-253, 254

FIG. 1 is a front elevational view of garden shears showing my new design;

FIG. 2 is an enlarged cross-sectional view thereof along a plane indicated by line 2—2 in FIG. 1;

FIG. 3 is an enlarged cross-sectional view thereof along a plane indicated by line 3—3 in FIG. 1;

FIG. 4 is a front elevational view showing an opened position thereof relative to FIG. 1;

FIG. 5 is an enlarged cross-sectional view thereof along a plane indicated by line 5—5 in FIG. 4;

FIG. 6 is a rear elevational view thereof; and,

FIG. 7 is a side elevational view thereof, to which the opposite side corresponds.

[56] **References Cited**

U.S. PATENT DOCUMENTS

D. 231,311	4/1974	Rogers	D8/5
D. 269,401	6/1983	Pittaway	D8/5
D. 344,220	2/1994	Wensley et al.	D8/5
D. 354,205	1/1995	Wensley et al.	D8/5

1 Claim, 3 Drawing Sheets

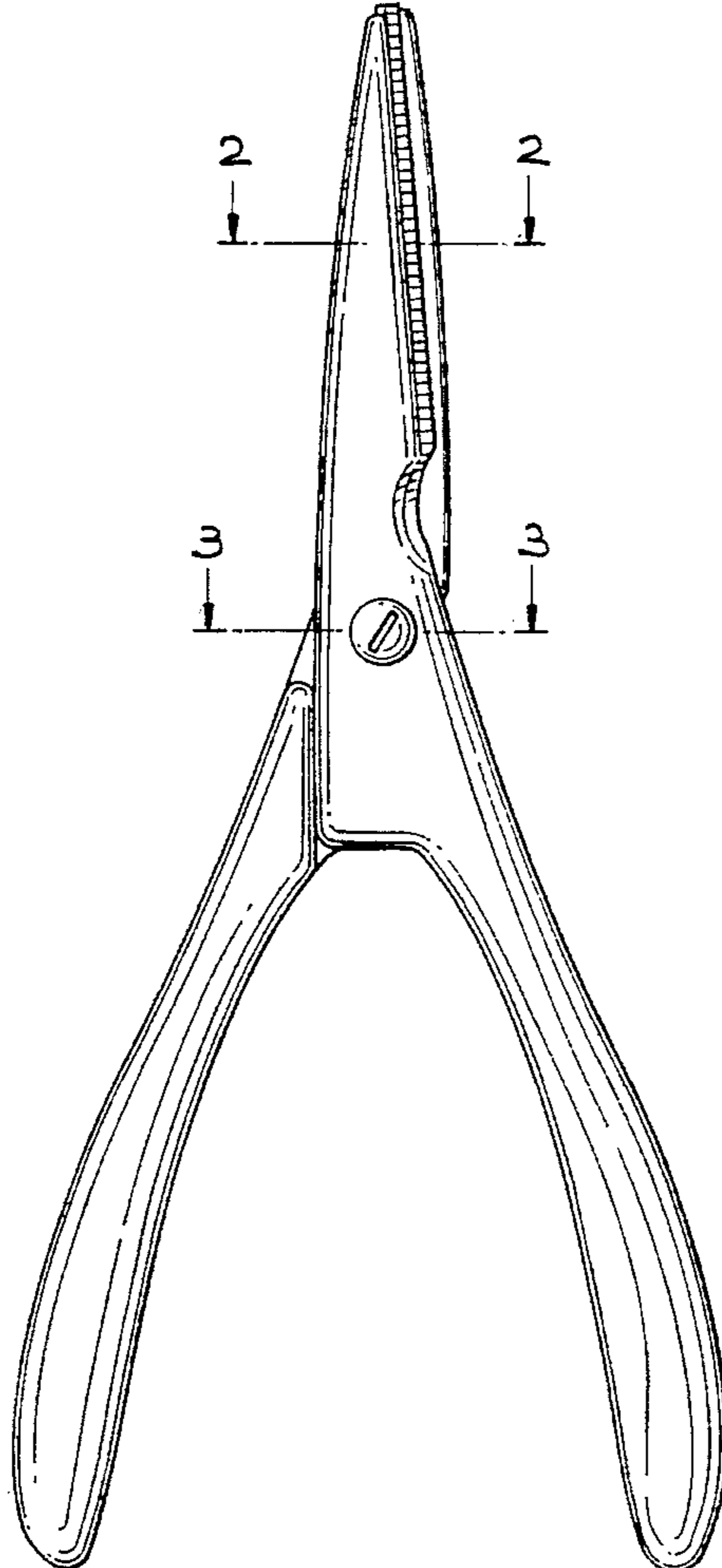

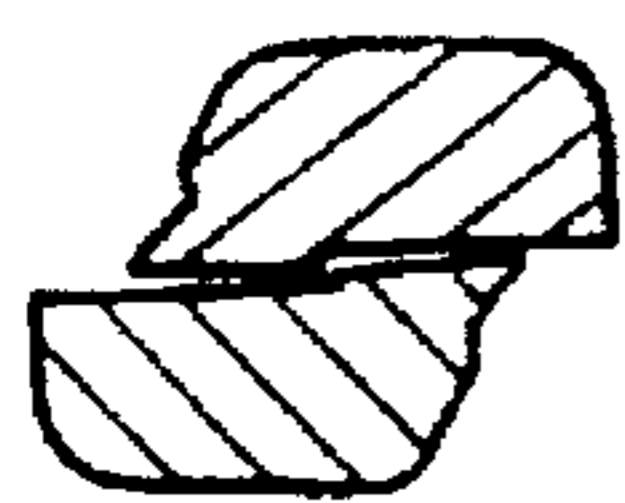

Fig. 2

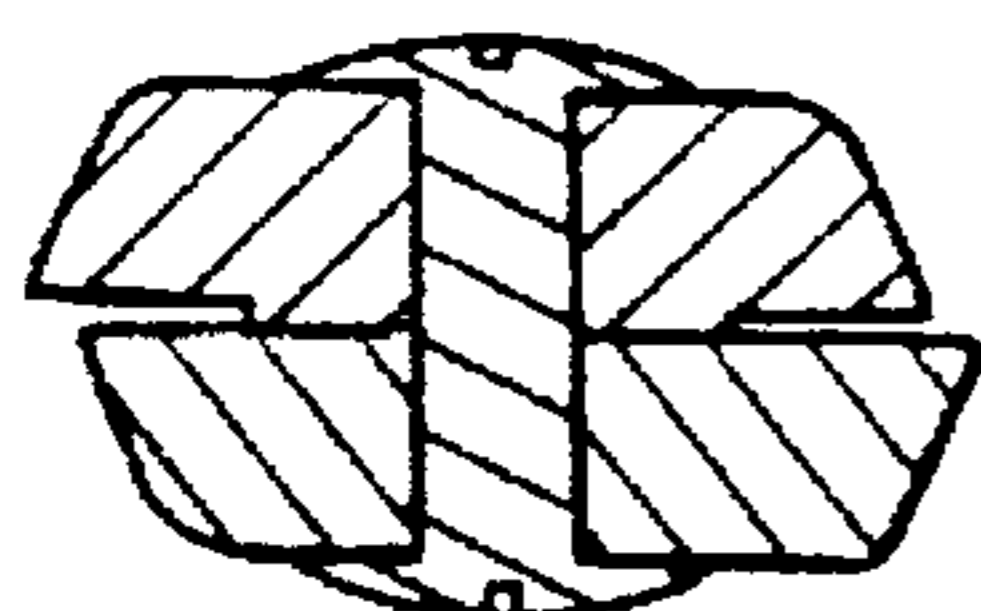

Fig. 3

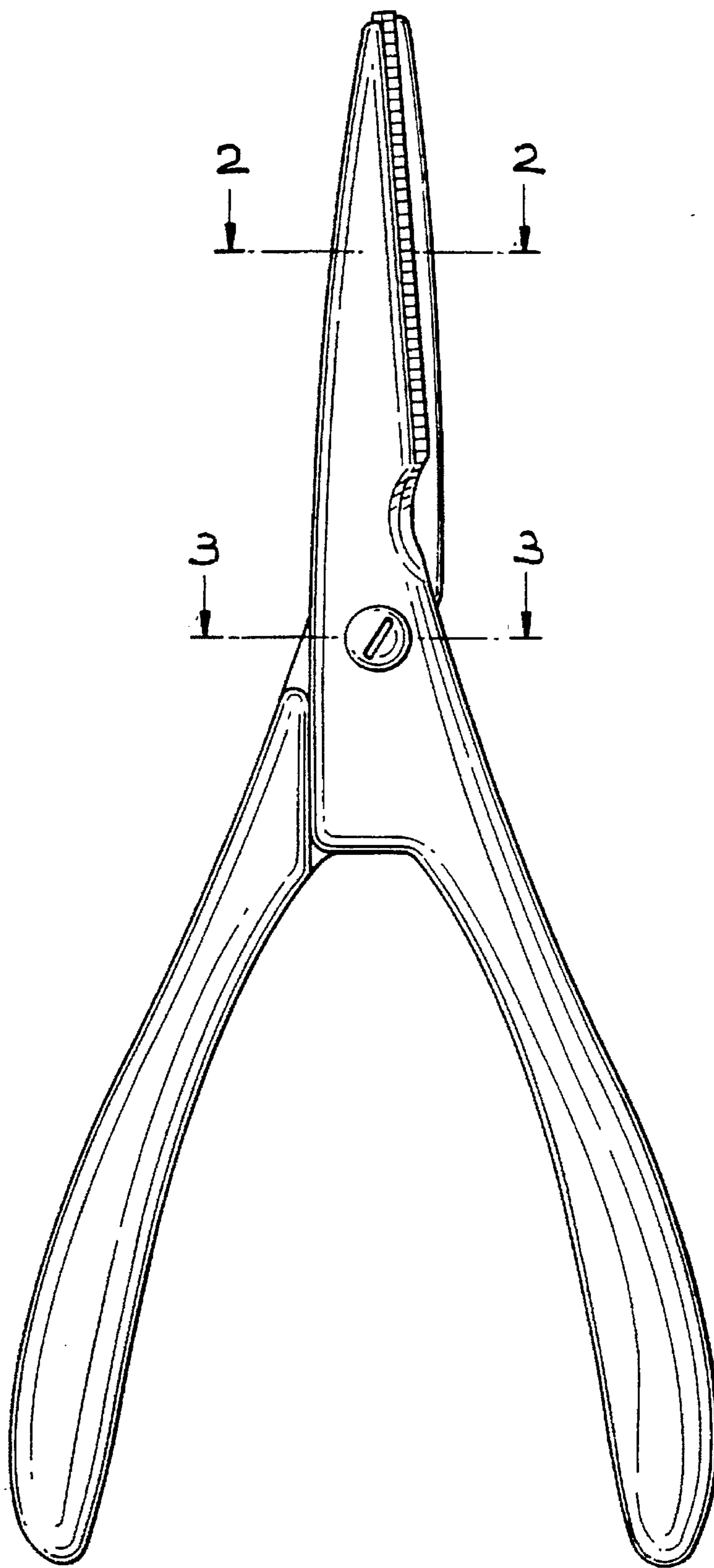

Fig. 1

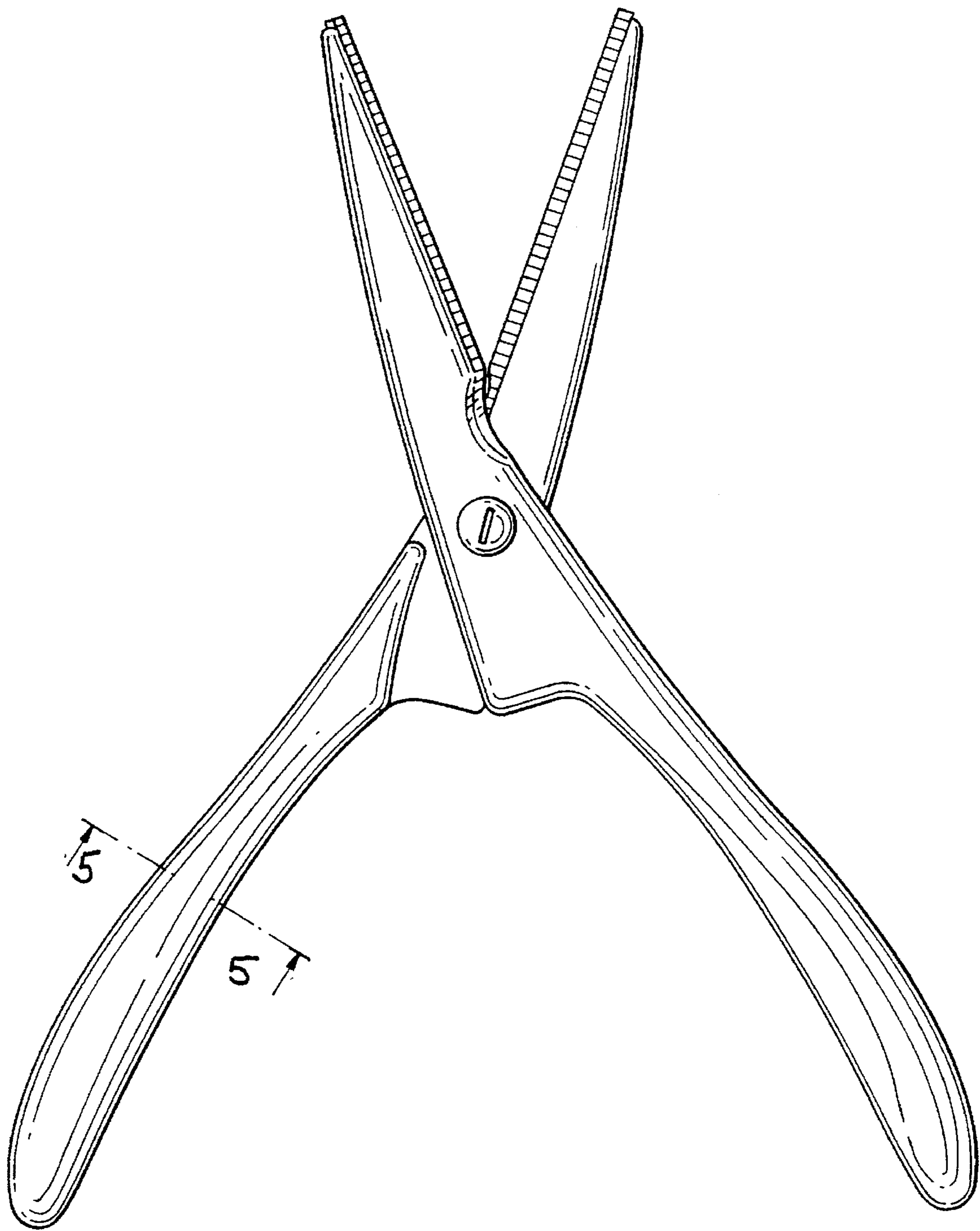

Fig. 4

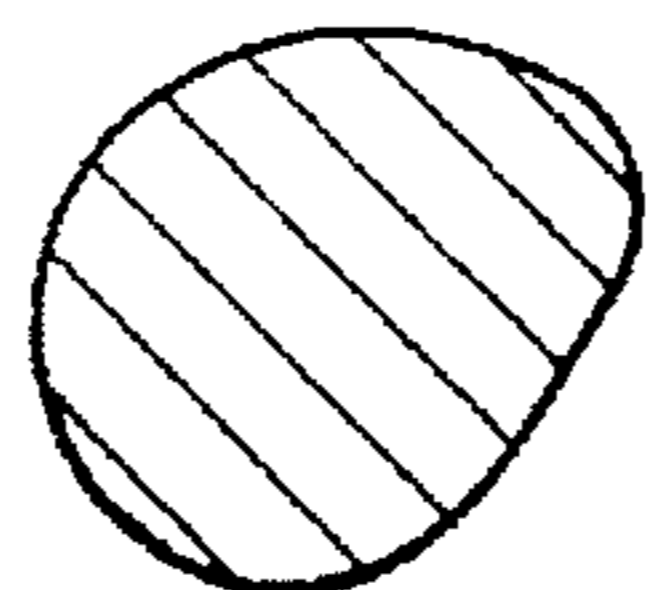

Fig. 5

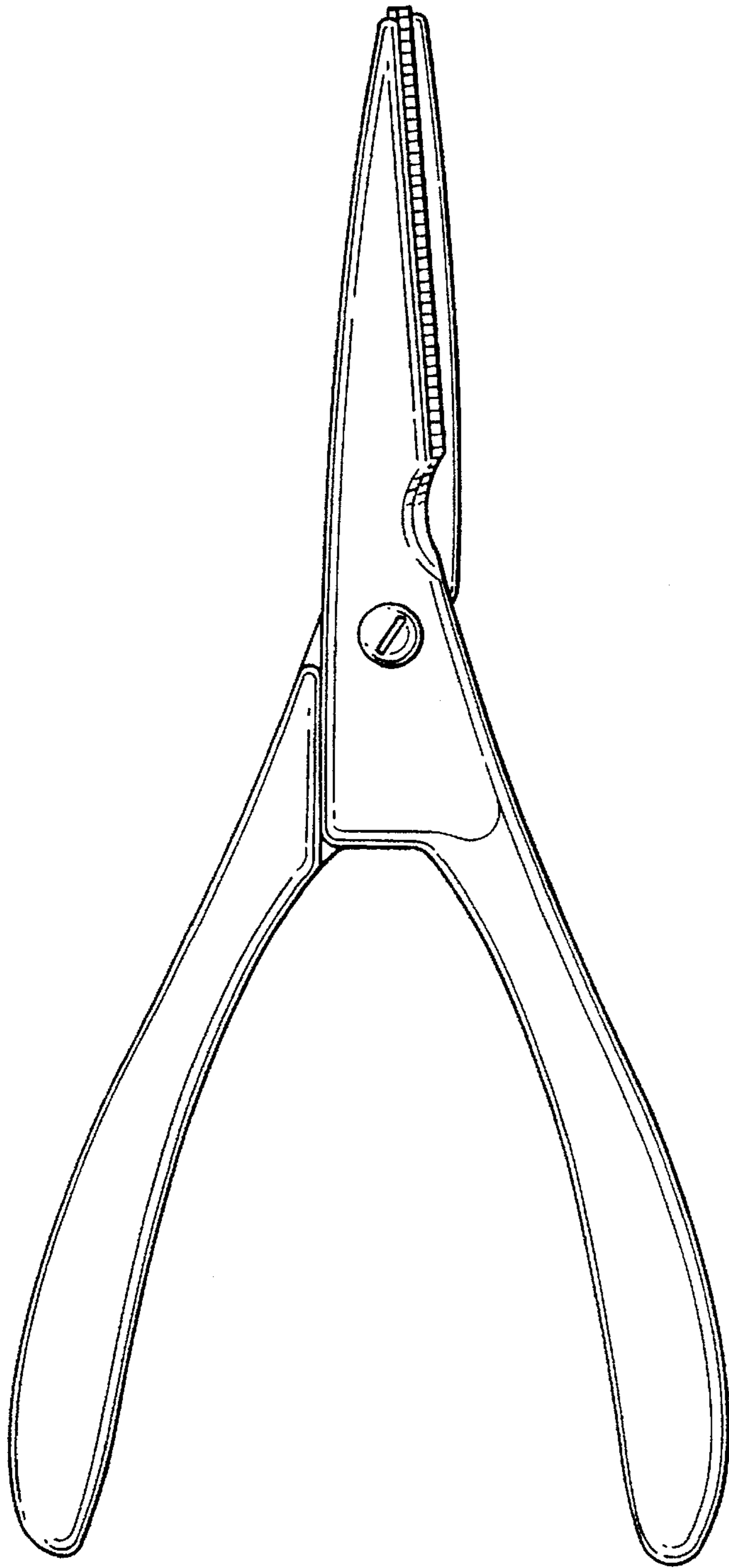

Fig. 6

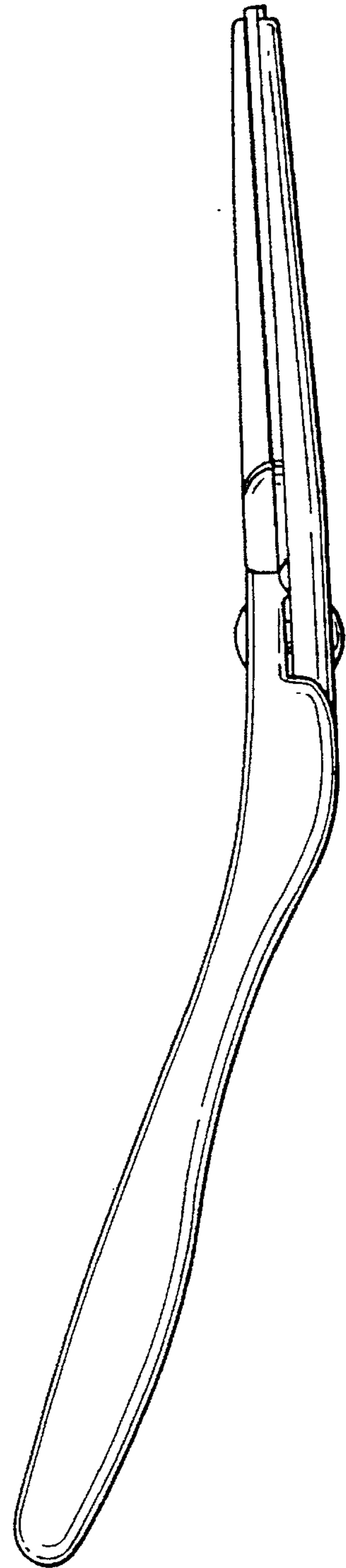

Fig. 7