



US00D381560S

# United States Patent [19]

[11] Patent Number: Des. 381,560

Indekeu

[45] Date of Patent: \*\*Jul. 29, 1997

[54] BREAD SERVER

5,409,126 4/1995 DeMars .

[75] Inventor: Erik D. W. Indekeu, Borgerhout, Belgium

### OTHER PUBLICATIONS

"Wine & Cheese Please". Housewares, p. 6, Jun., 1982. Rectangular Storage Container, Superseal Store & Server, HFD, p. 60 Mar. 7, 1988.

[73] Assignee: Dart Industries Inc., Orlando, Fla.

Primary Examiner—M. N. Pandozzi  
Attorney, Agent, or Firm—John A. Doninger

[\*\*] Term: 14 Years

[21] Appl. No.: 53,896

### [57] CLAIM

[22] Filed: Jan. 11, 1996

The ornamental design for a bread server, as shown and described.

[51] LOC (6) Cl. .... 07-01

### DESCRIPTION

[52] U.S. Cl. .... D7/538; D7/543; D7/607; D7/629; D7/505

[58] Field of Search ..... D7/554, 609, 601, D7/612, 505, 538, 543, 545, 548, 550, 698, 602, 629; D9/432, 423, 429, 425; 220/675, 671, 660, 608, 556, 578, 23.8

FIG. 1 is a top, front, and side perspective view of a bread server showing my new design, with the cutting board portion removed for ease of illustration; FIG. 2 is an exploded perspective view thereof; FIG. 3 is a top plan view thereof; FIG. 4 is a bottom plan view thereof; FIG. 5 is a front elevation view thereof; FIG. 6 is a rear elevation view thereof; FIG. 7 is a left side elevation view thereof; FIG. 8 is a right side elevation view thereof; FIG. 9 is a cross-section thereof taken on line 9—9 in FIG. 3;

### [56] References Cited

#### U.S. PATENT DOCUMENTS

- D. 174,831 5/1955 Nowak ..... D7/550
- D. 178,985 10/1956 Block ..... D7/545
- D. 262,839 2/1982 Daenen et al. .... D7/629 X
- D. 282,808 3/1986 Daenen et al. .... D7/629 X
- D. 284,253 6/1986 Carlson ..... D7/629
- D. 284,254 6/1986 Carlson ..... D7/629
- D. 298,903 12/1988 Watson et al. .... D7/545
- D. 330,996 11/1992 Smith et al. .... D9/425 X
- D. 332,204 1/1993 Carlson ..... D7/629
- D. 348,394 7/1994 Dreyer ..... D9/425
- D. 348,805 7/1994 Cautereels ..... D7/602
- D. 350,880 9/1994 Van Valkenburg et al. .... D7/629
- D. 353,080 12/1994 Cantereels et al. .
- D. 357,161 4/1995 Booten ..... D7/538 X
- D. 365,251 12/1995 Lo ..... D7/538 X
- D. 366,397 1/1996 Zimmerman ..... D7/538 X
- 2,695,645 11/1954 Tupper ..... D7/609 X
- 3,417,895 12/1968 Penton .
- 3,642,165 2/1972 von der Osten .
- 4,091,953 5/1978 Daenen .
- 5,009,053 4/1991 Langenbeck et al. .... 220/671 X

FIG. 10 is a cross-section thereof taken on line 10—10 in FIG. 3; FIG. 11 is a top, front, and side perspective view of a bread server with the cutting board between the base and lid/tray portions; FIG. 12 is an exploded perspective view of FIG. 11; FIG. 13 is a cross-section taken on line 13—13 in FIG. 11; FIG. 14 is a top, front, and side perspective view of a bread server in an alternate position with the lid/tray inverted and the cutting board overlying the lid/tray; FIG. 15 is an exploded perspective view of FIG. 14; and, FIG. 16 is a cross-section taken on line 16—16 in FIG. 14.

1 Claim, 11 Drawing Sheets

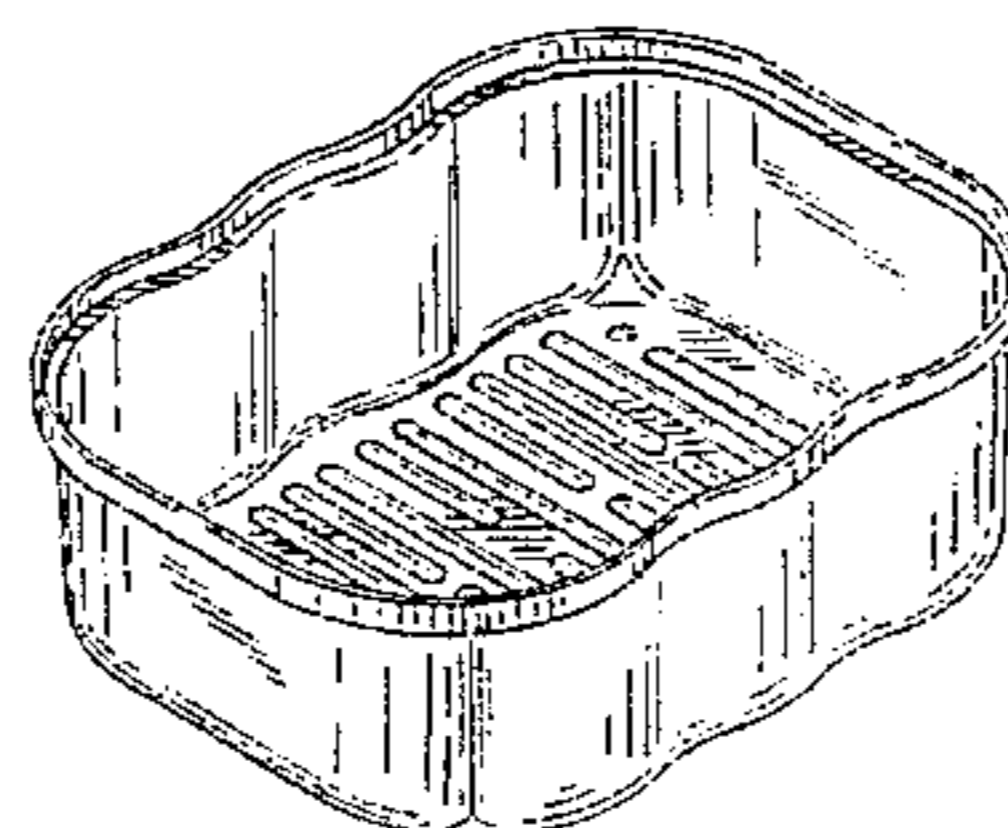
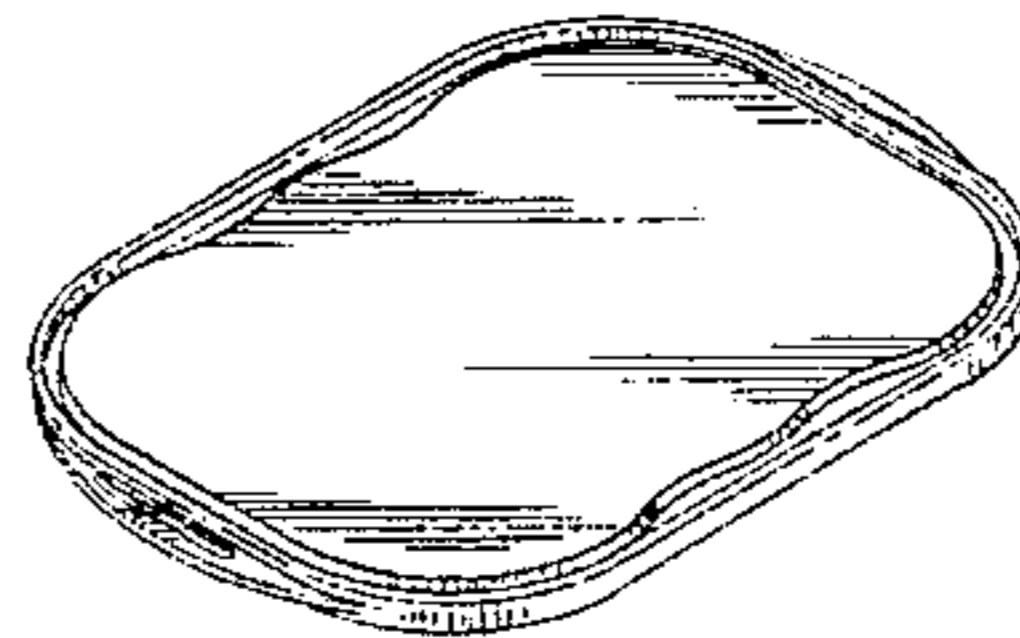
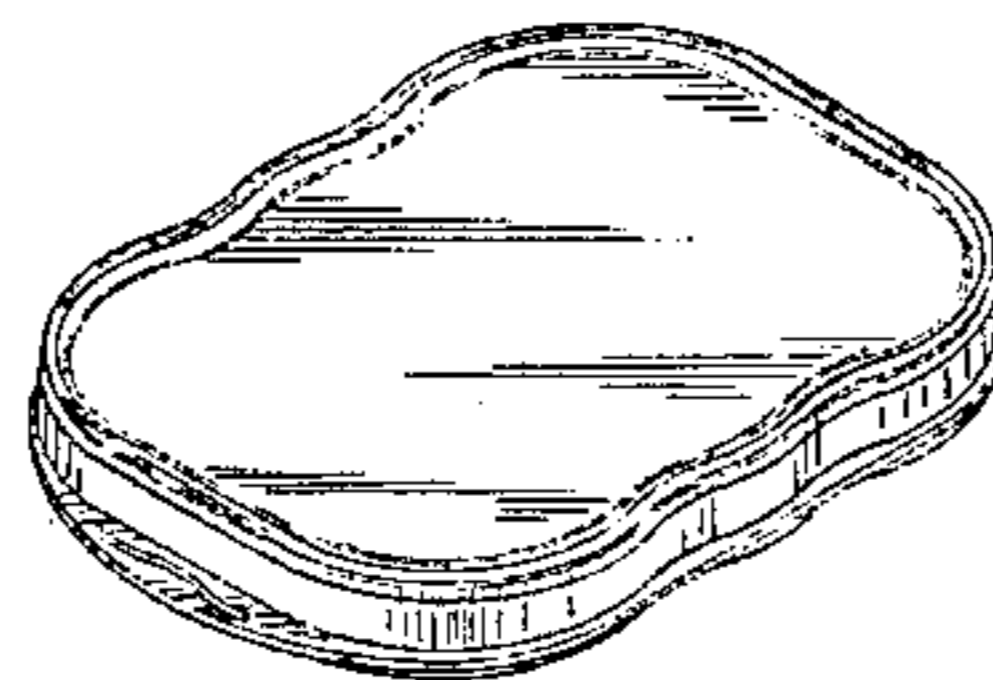

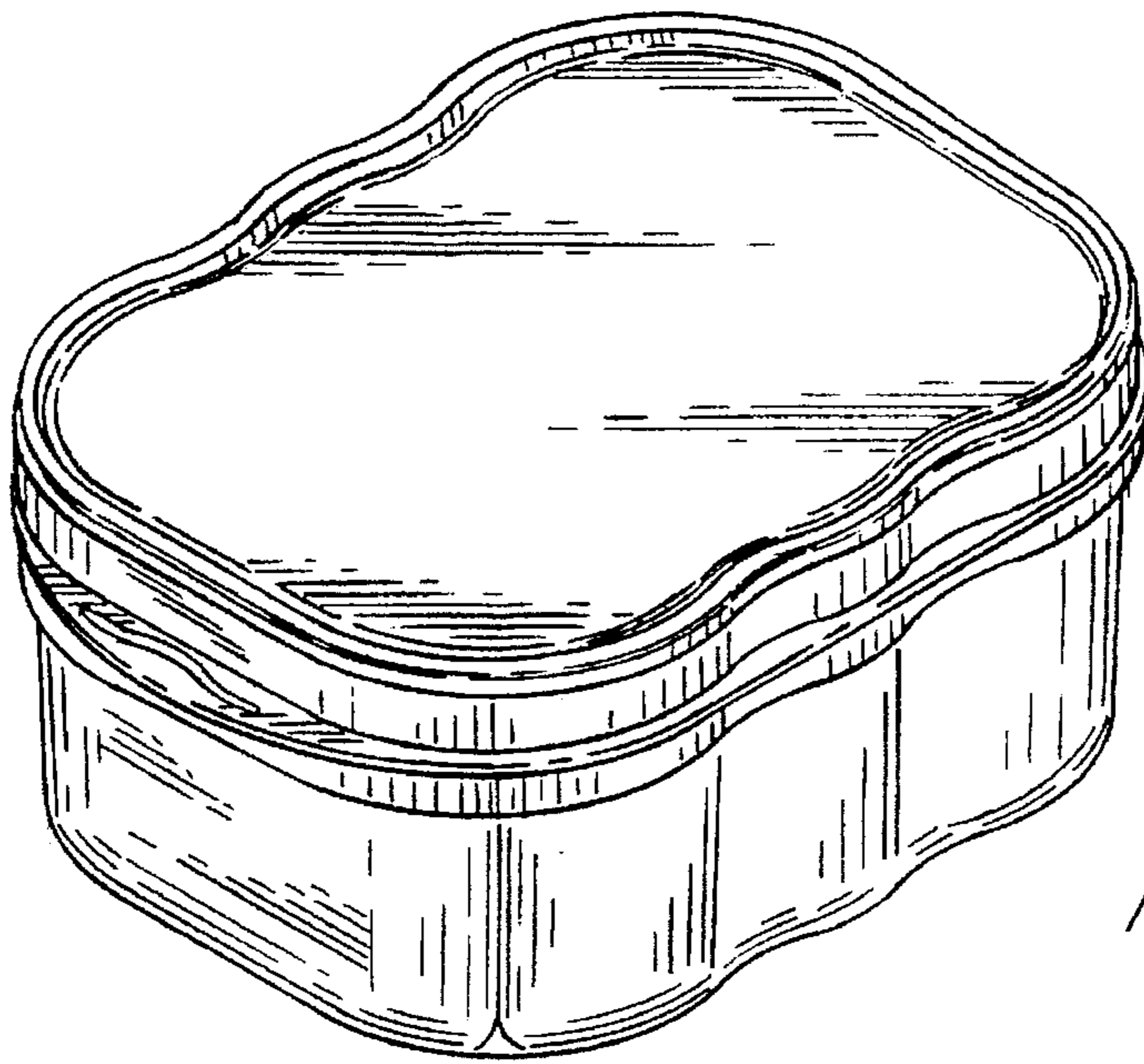

FIG. 1

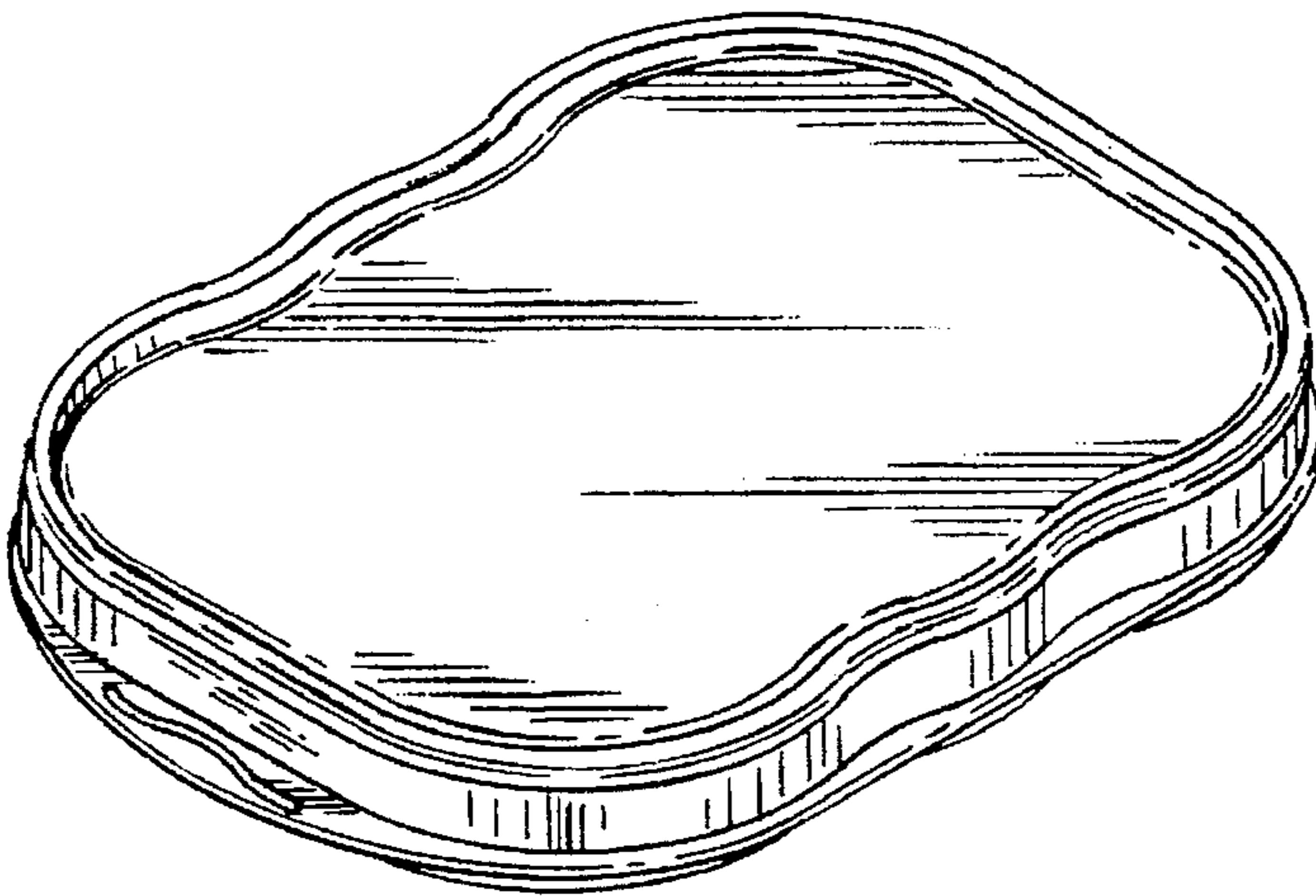
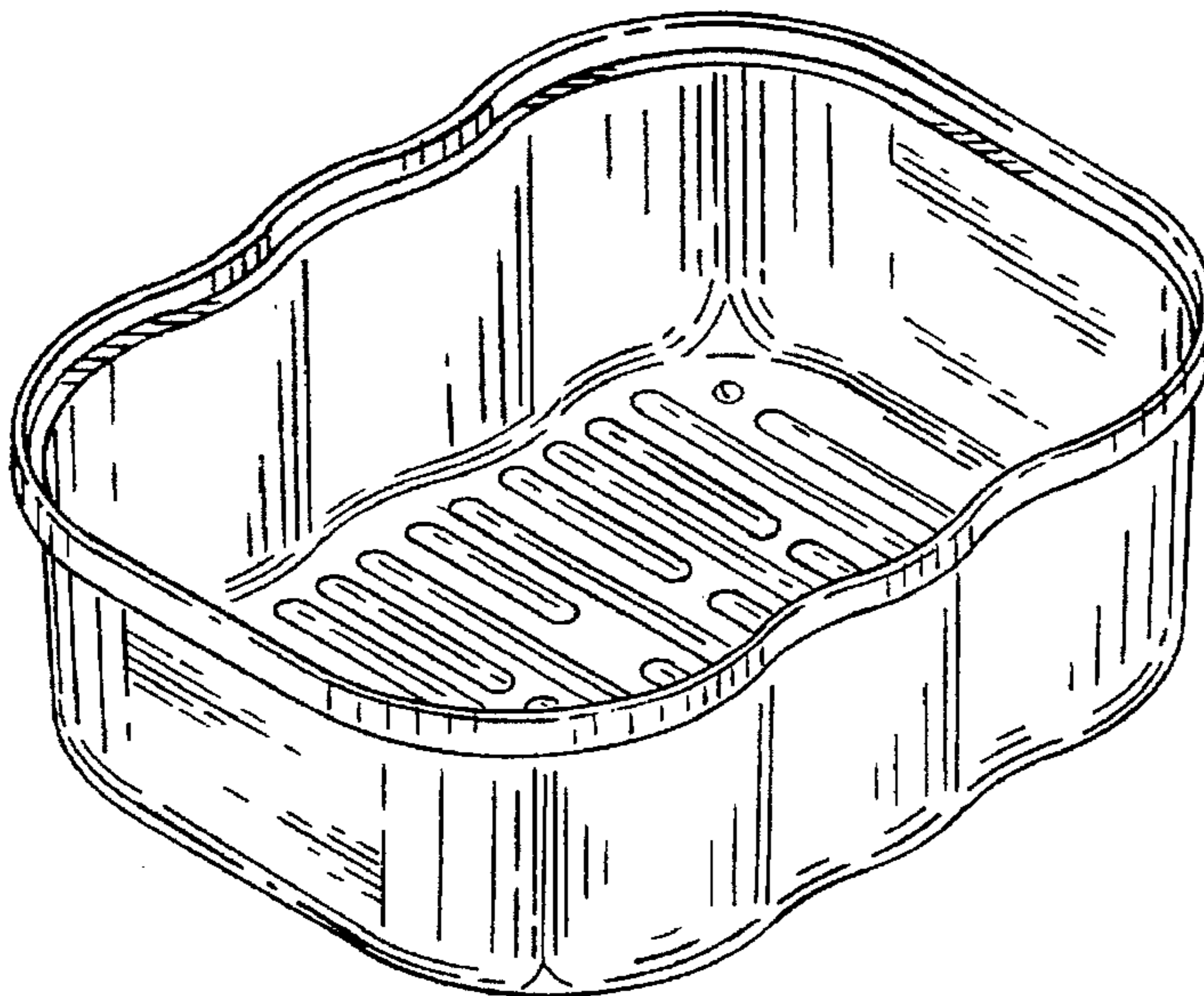

FIG. 2



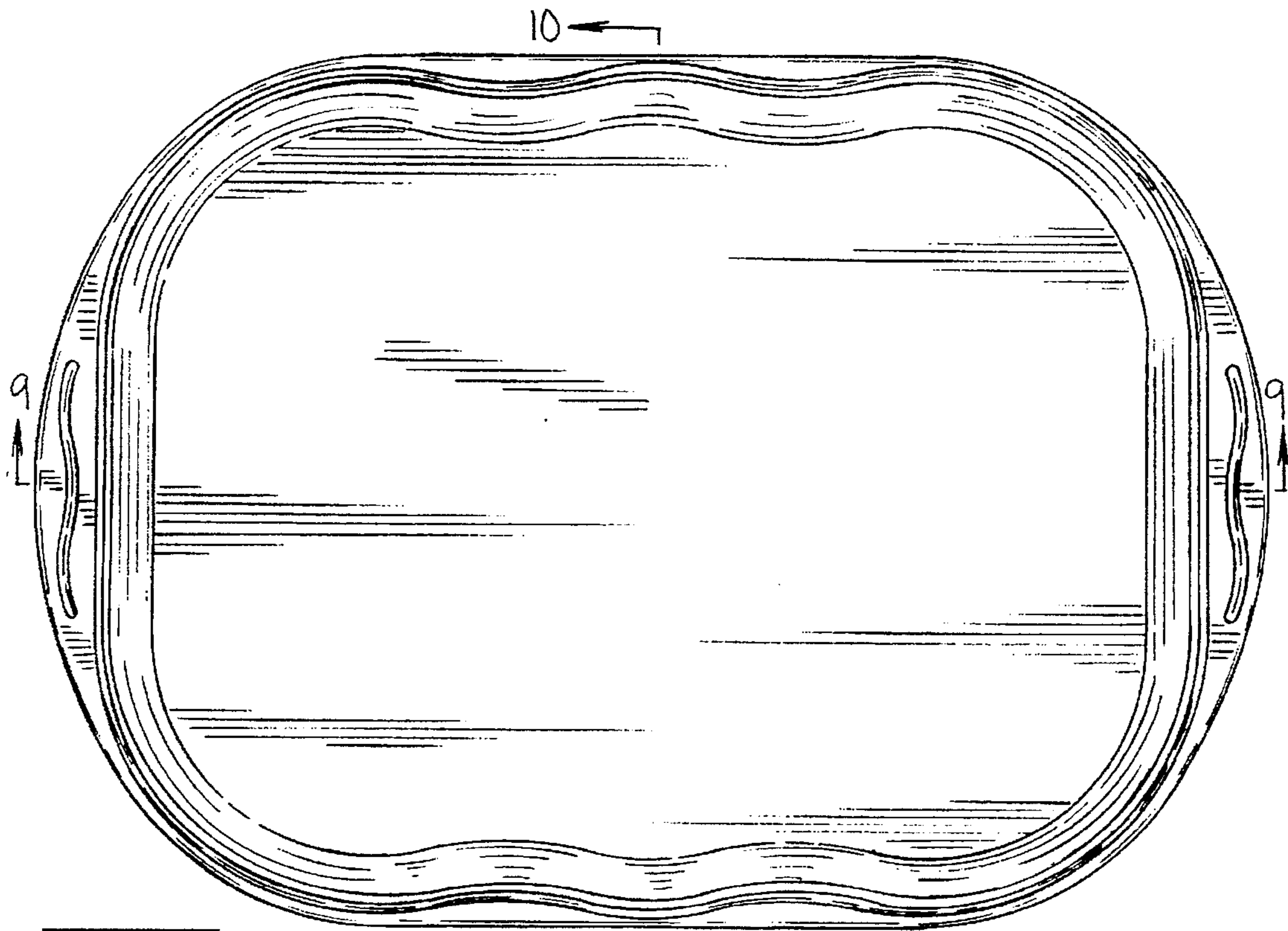

FIG. 3

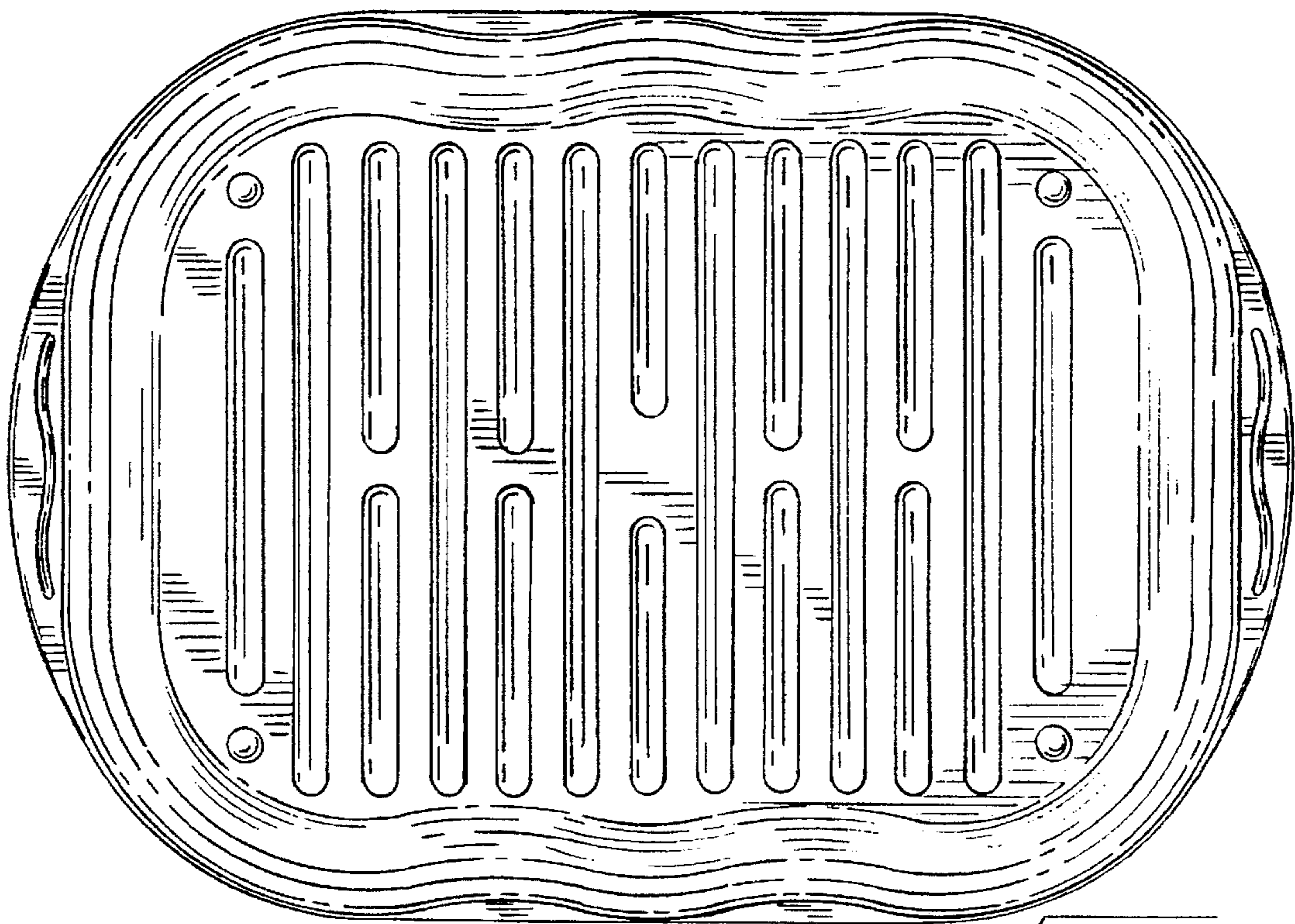

FIG. 4

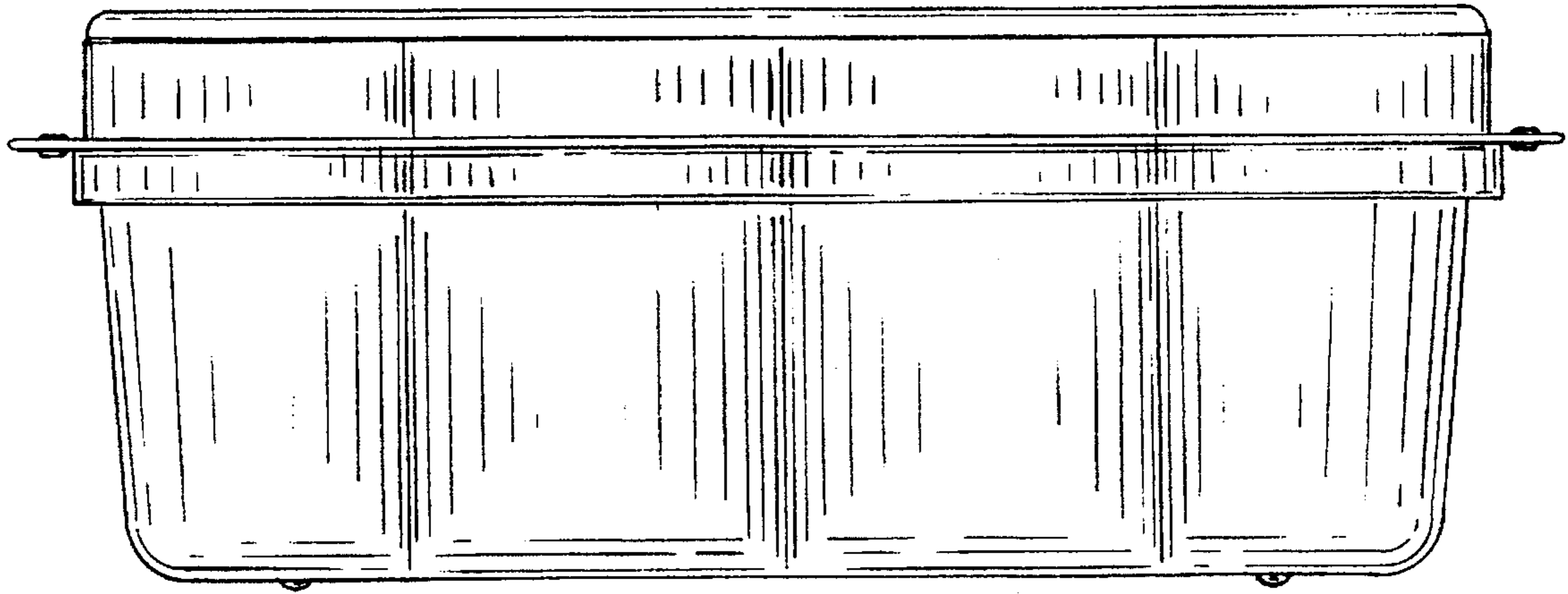

FIG. 5

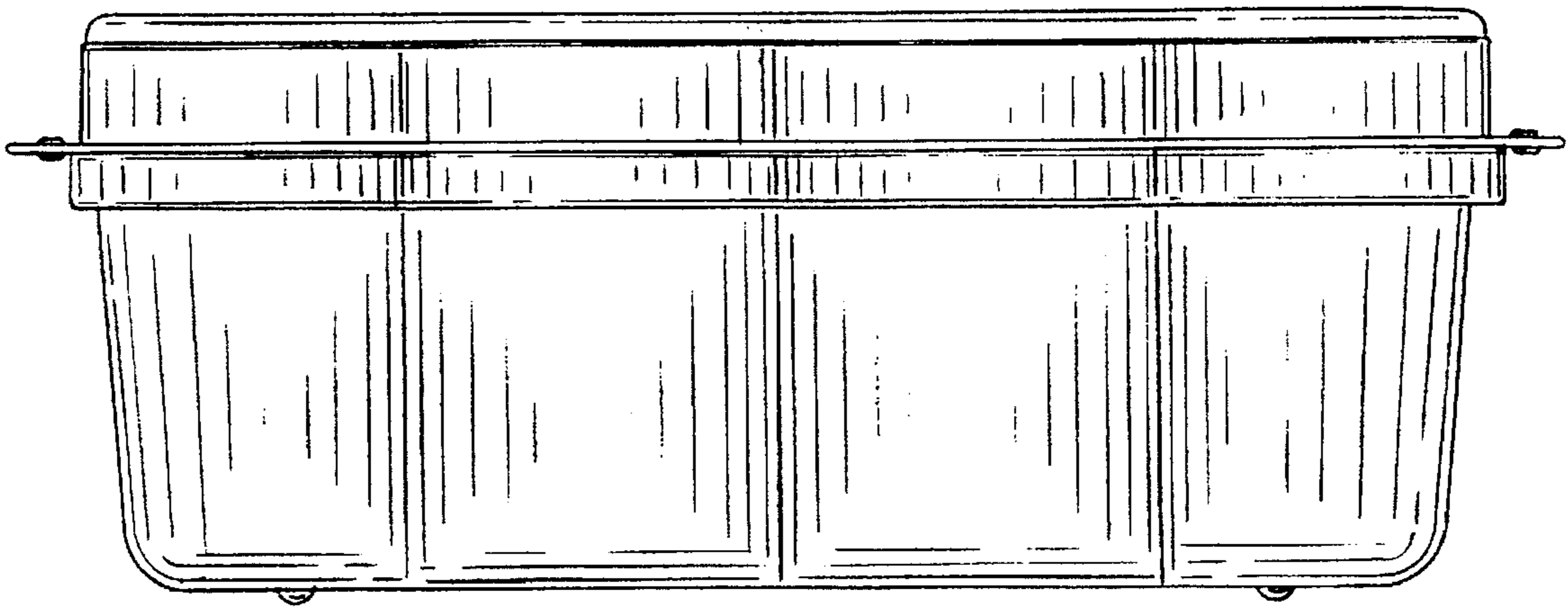

FIG. 6

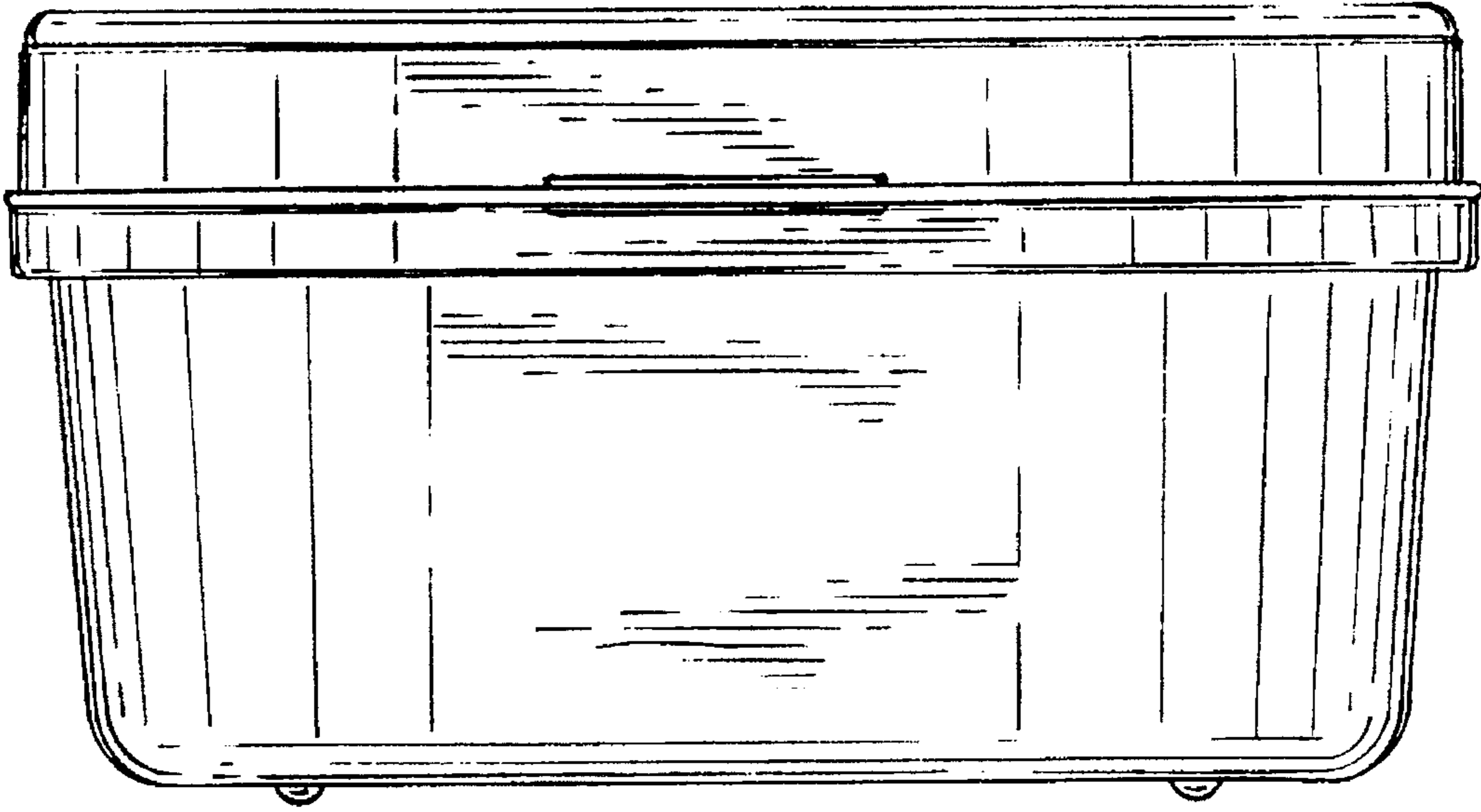

FIG. 7

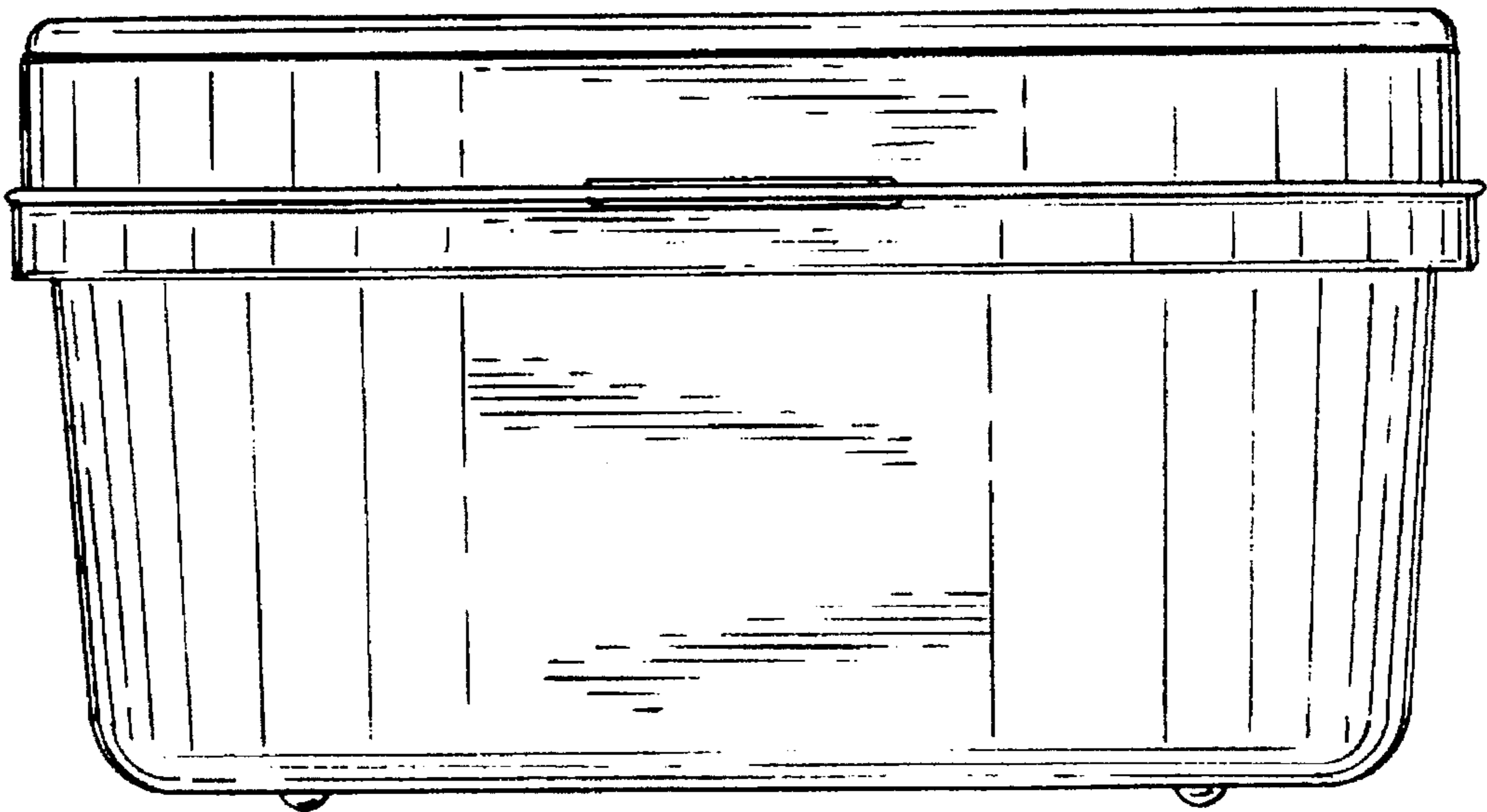

FIG. 8

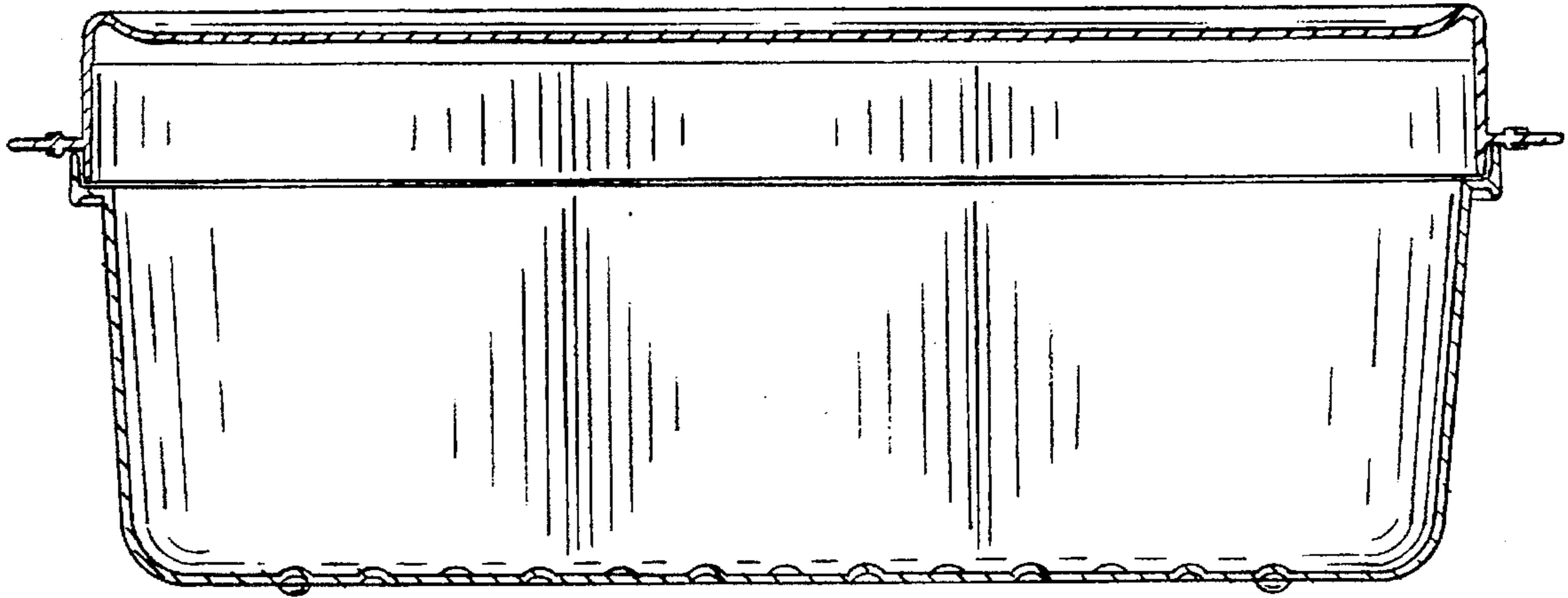

FIG. 9

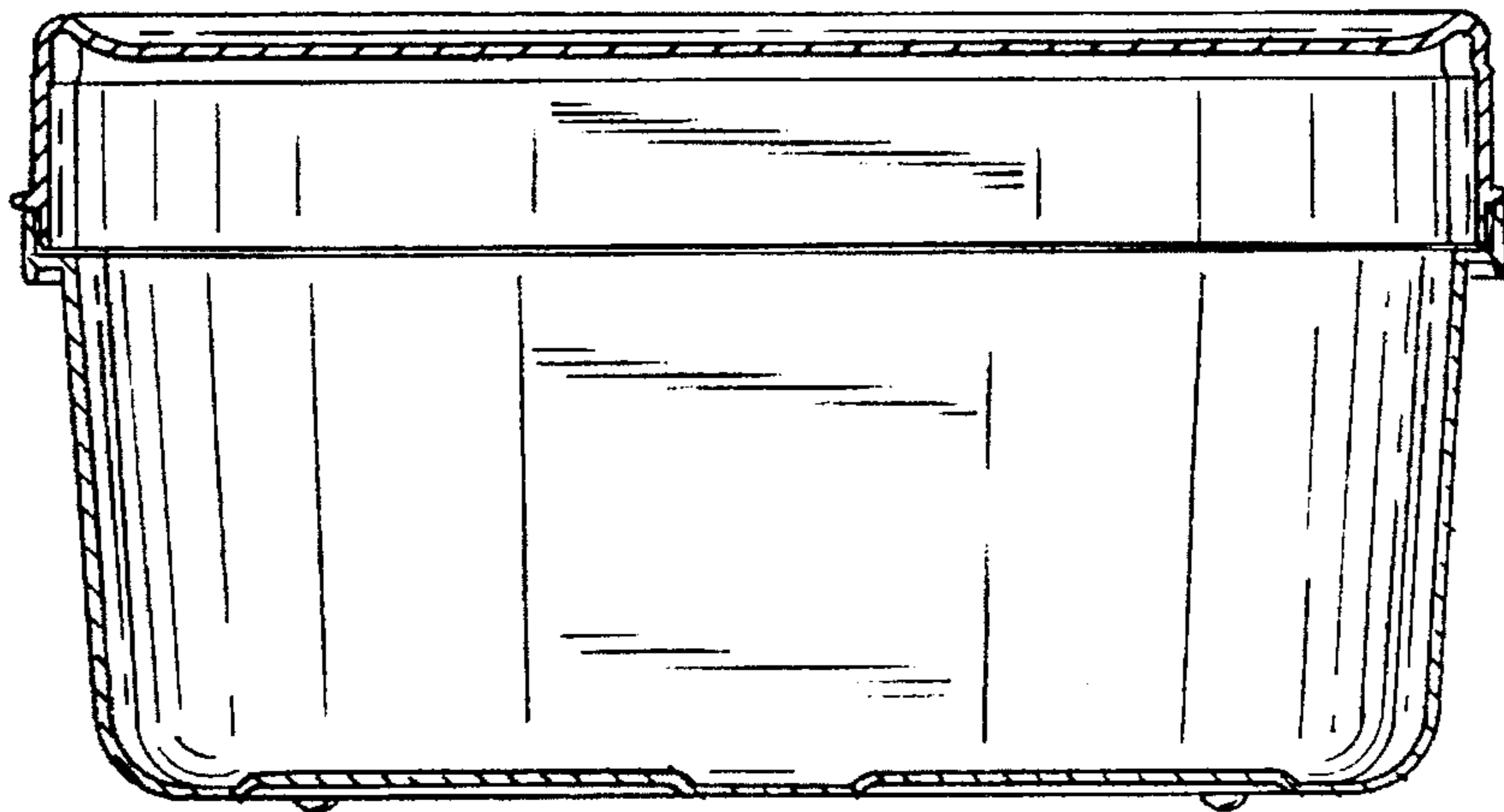

FIG. 10

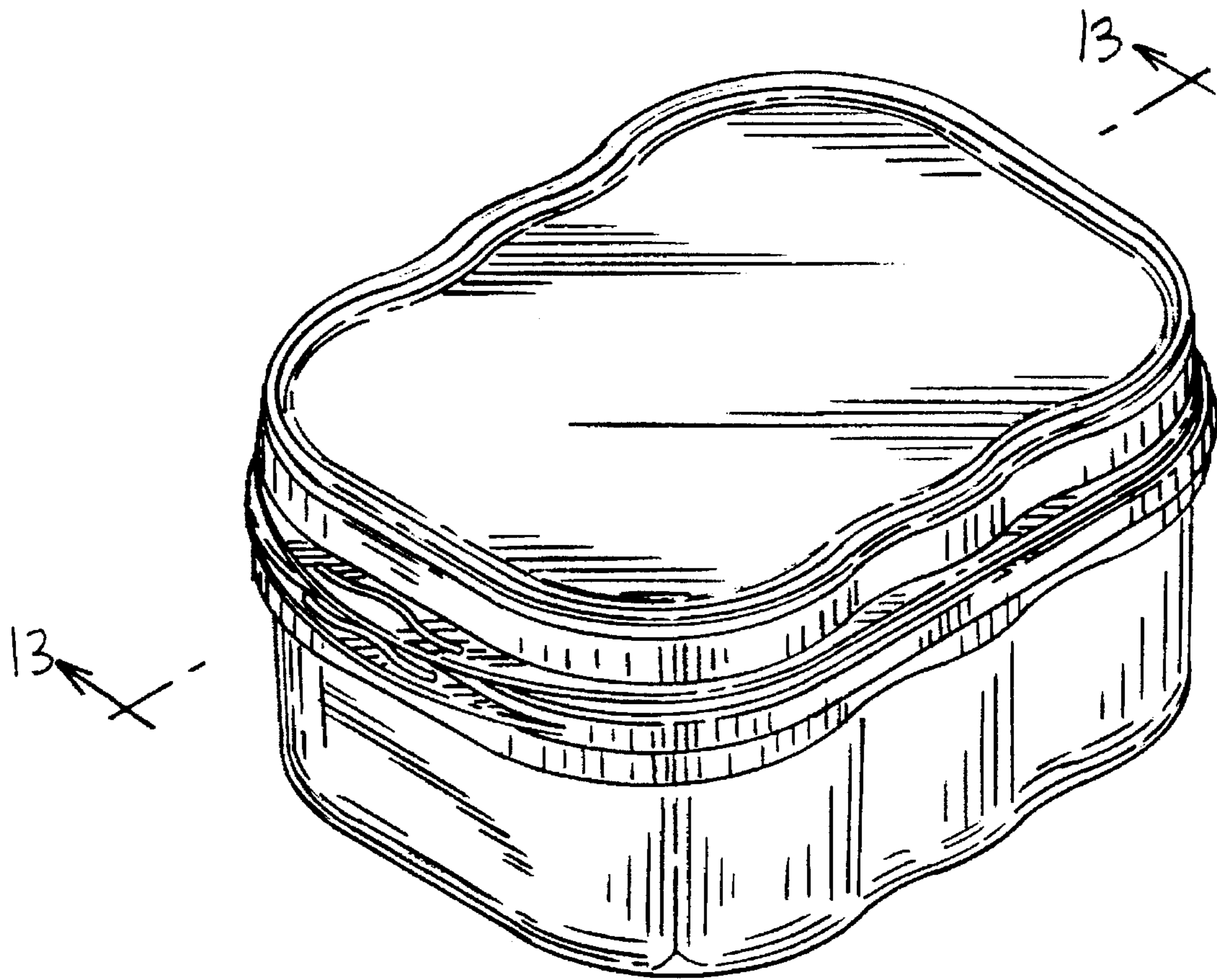

FIG. 11

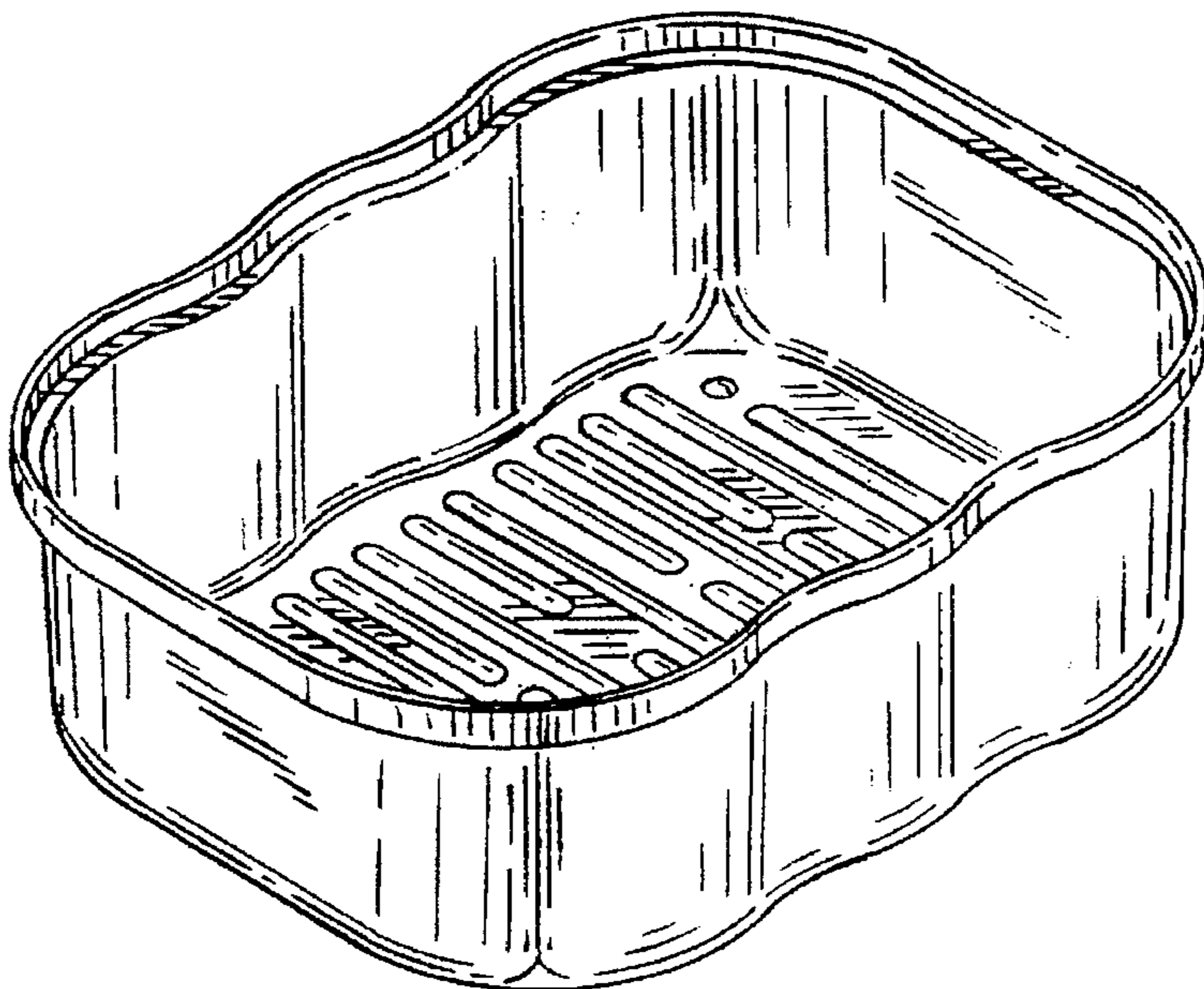
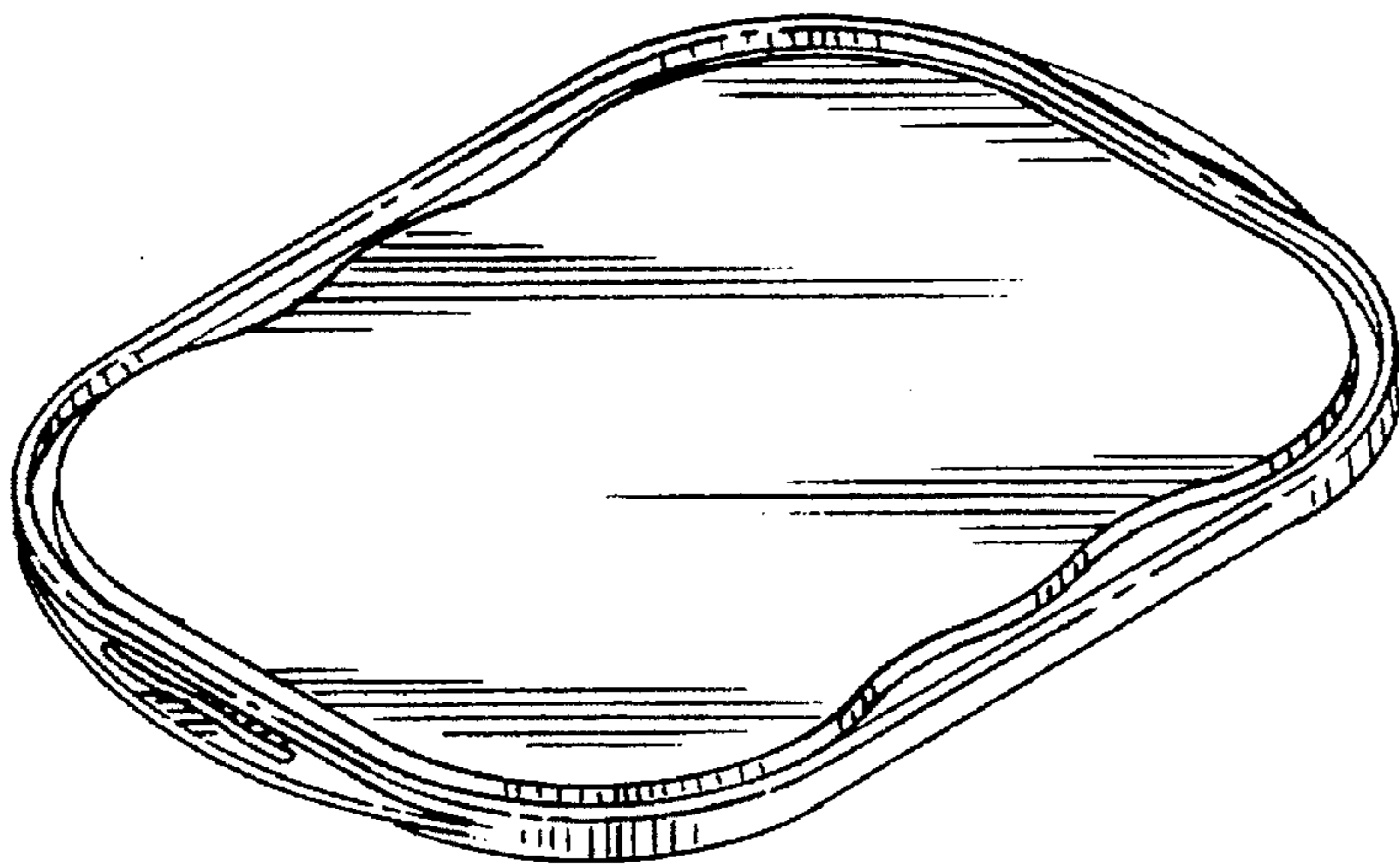
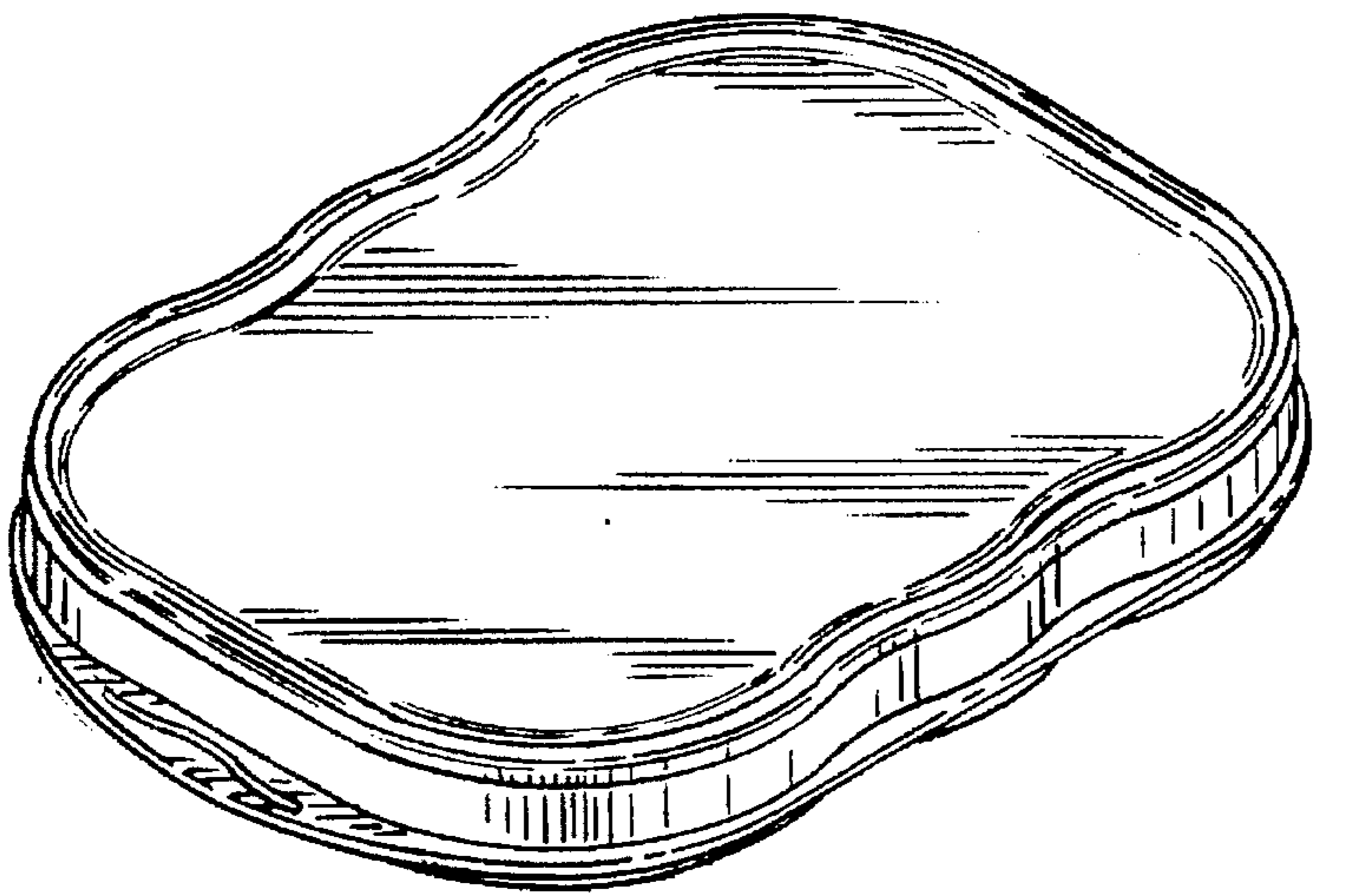

FIG. 12



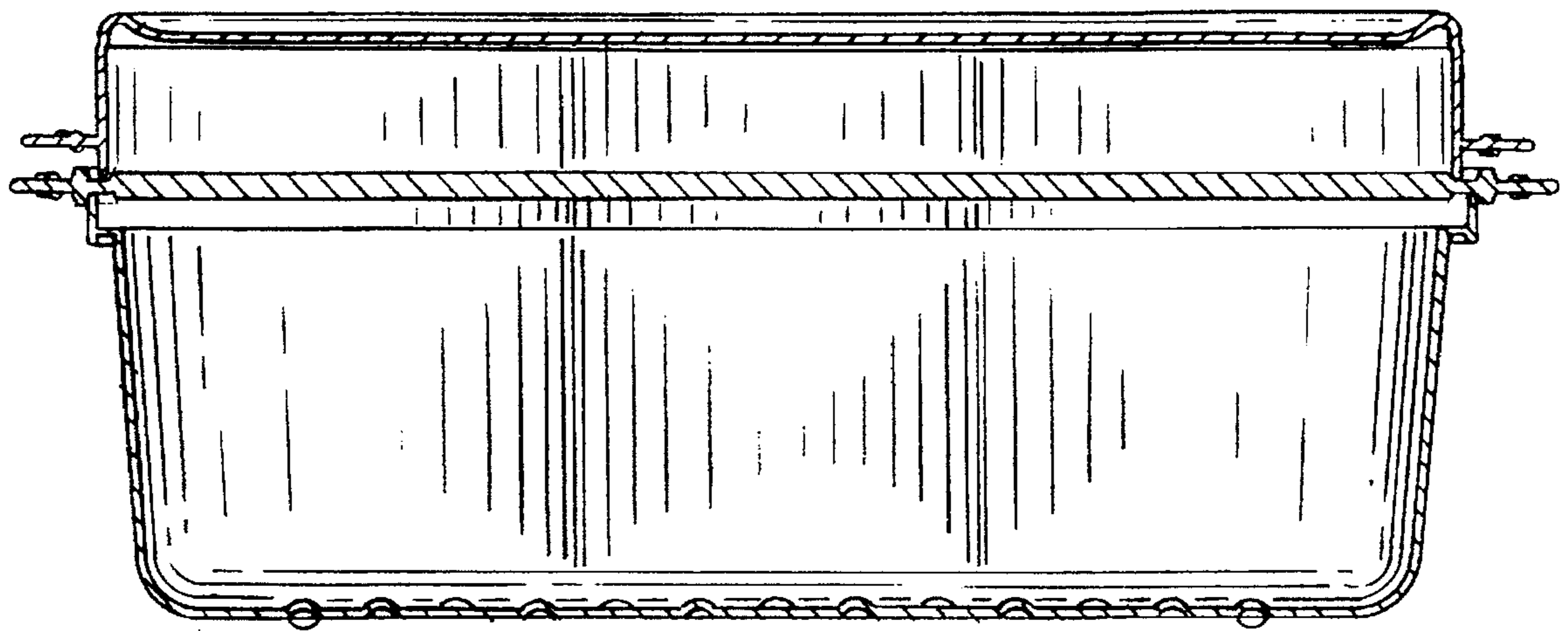

FIG. 13

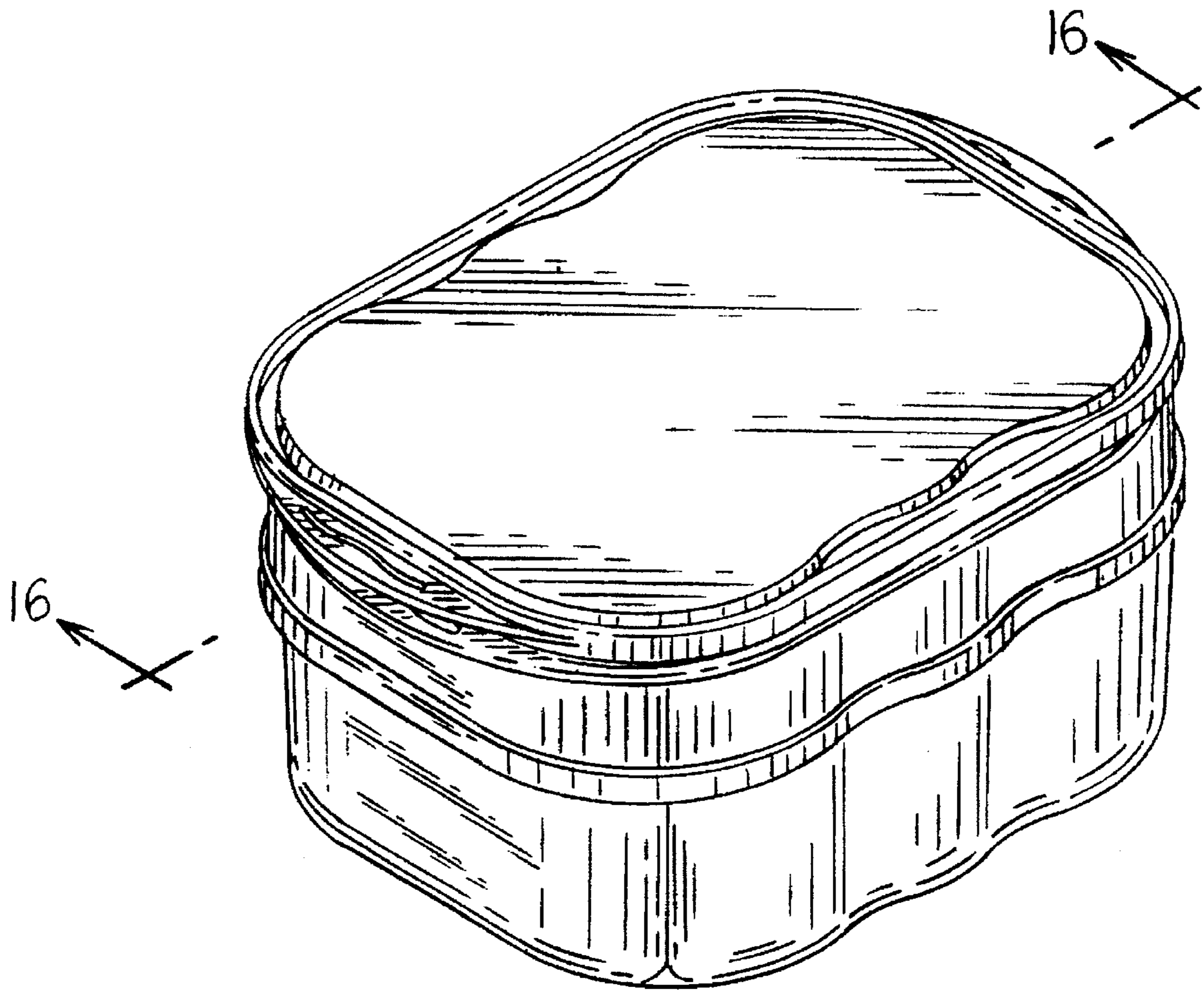

FIG. 14

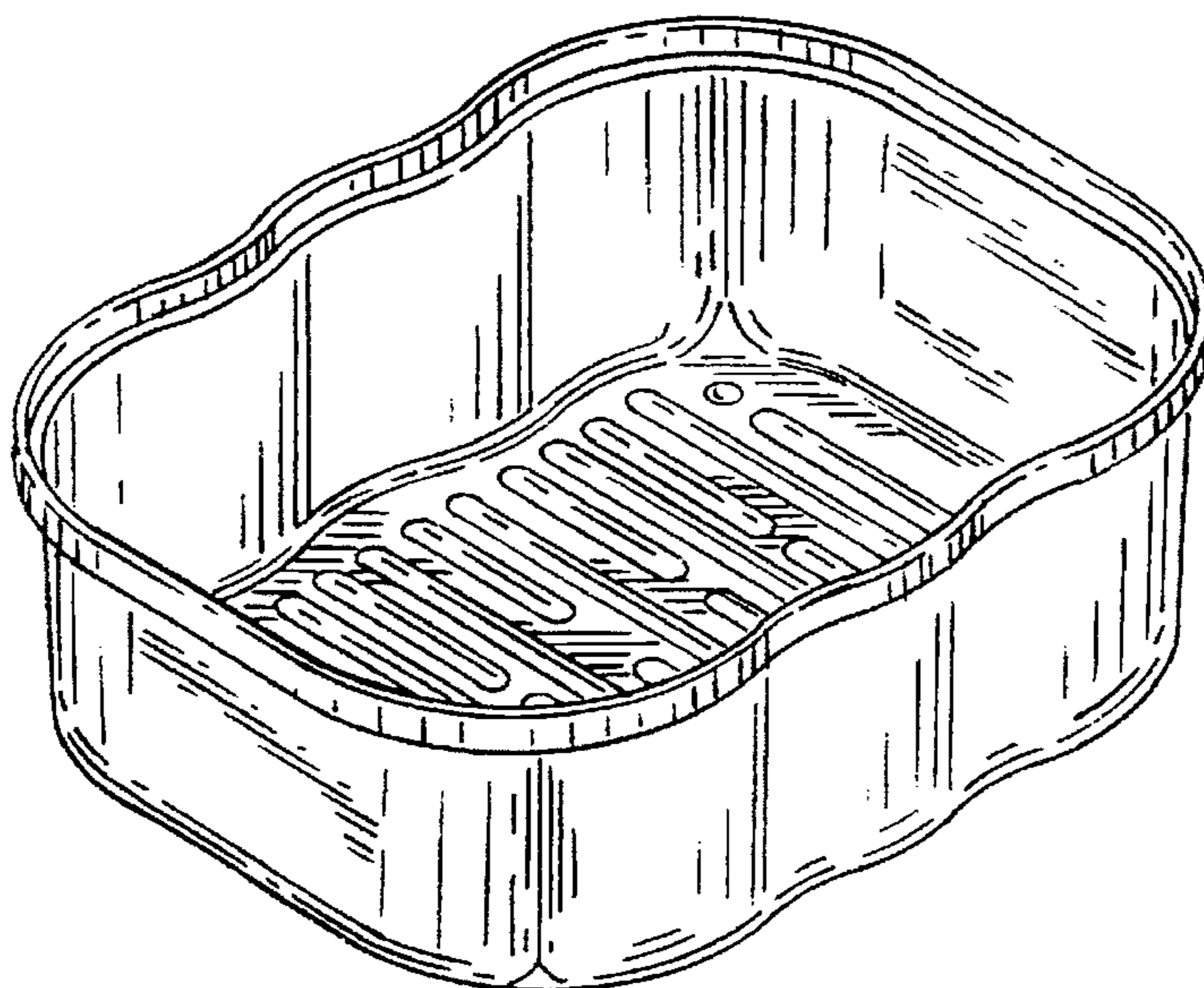
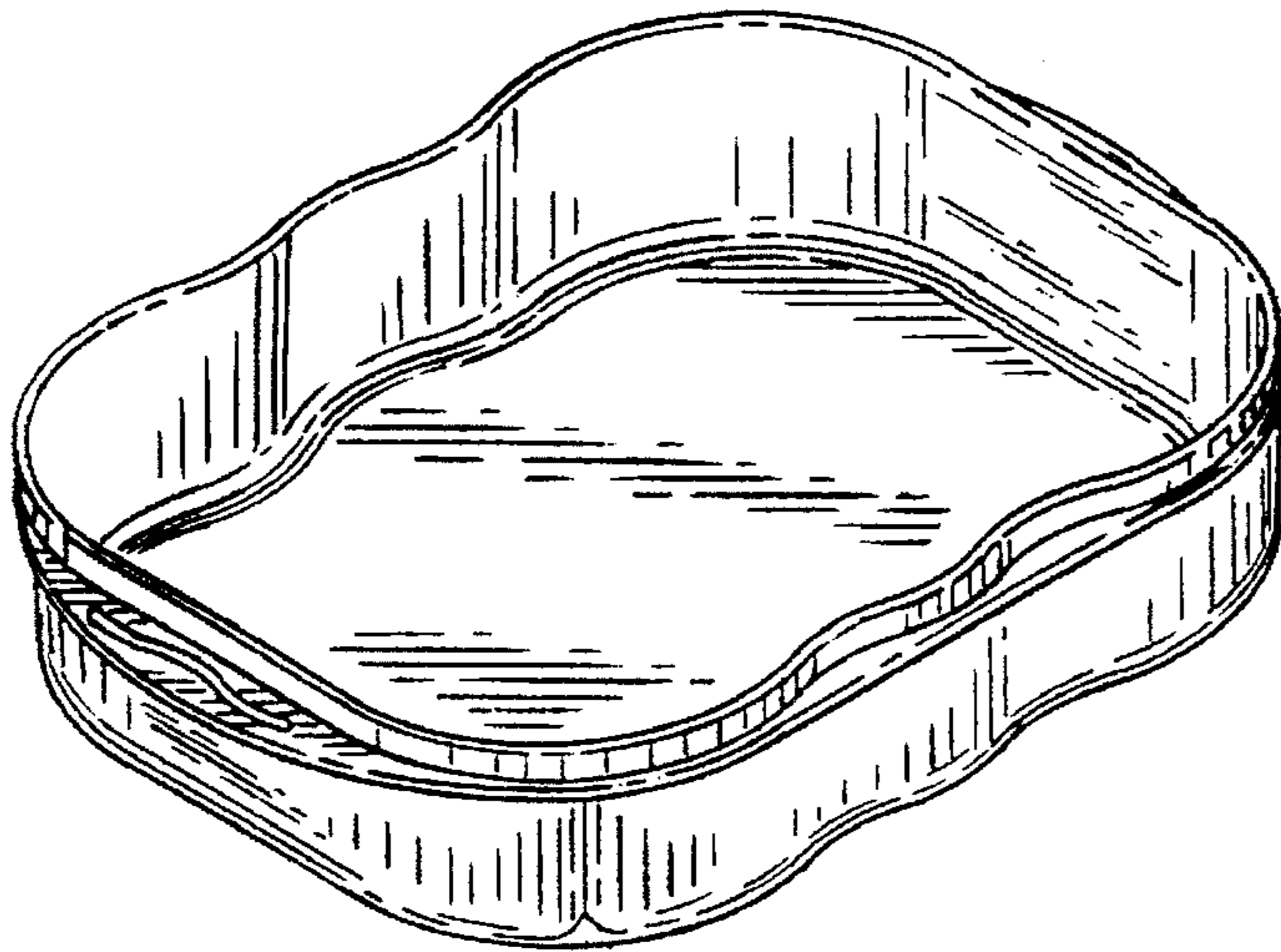
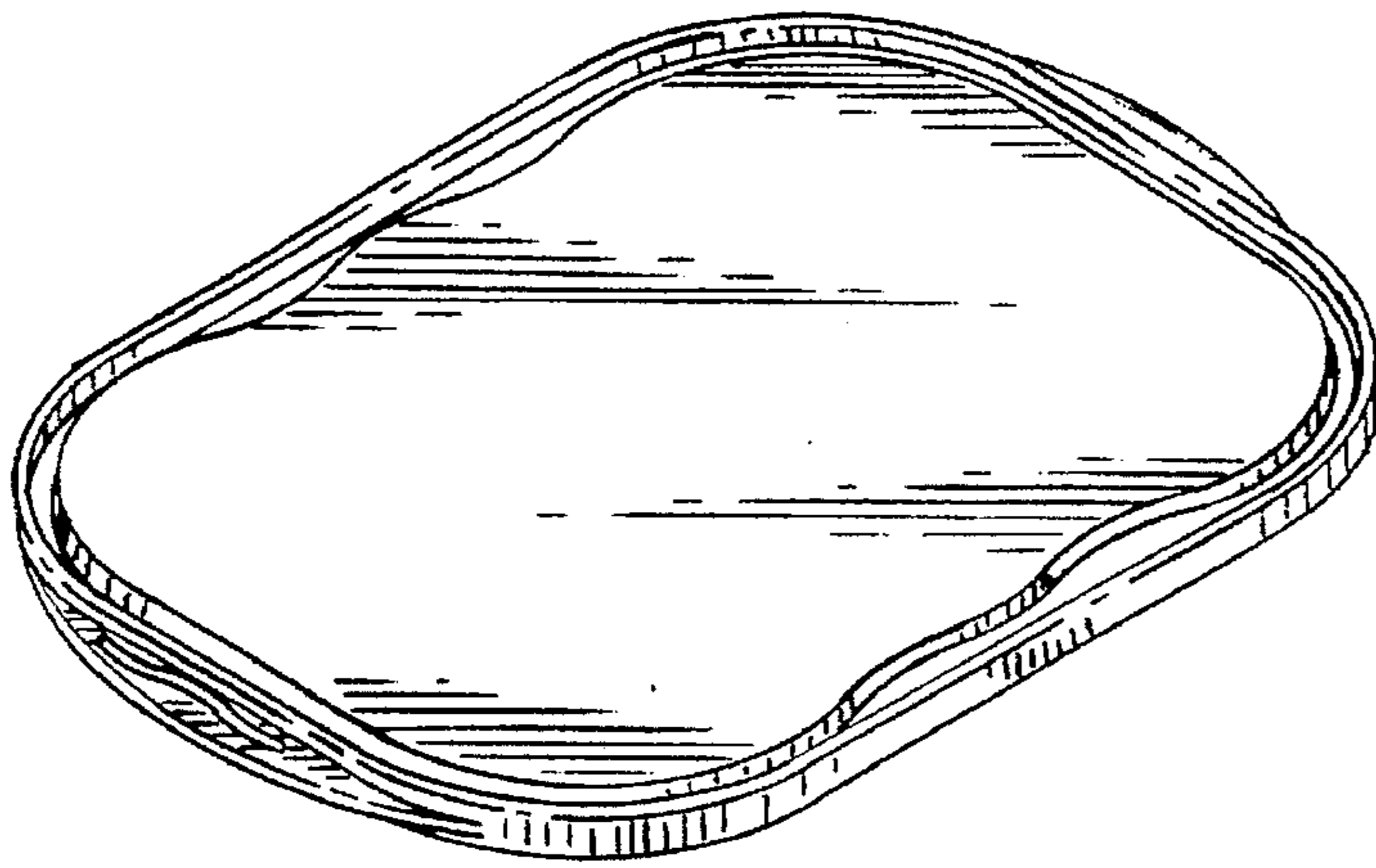

FIG. 15

FIG. 1B

