



US00D381440S

**United States Patent** [19]  
**Cheung**

[11] **Patent Number: Des. 381,440**

[45] **Date of Patent: \*\*Jul. 22, 1997**

[54] **STAR-SHAPED LIGHT BULB**

[76] **Inventor: Anthony Yi Choi Cheung, Block B,  
Flat 1406, Lai Mga House, Hong Nga  
Court, Lam Tin, Kowloon, Hong Kong**

[\*\*] **Term: 14 Years**

[21] **Appl. No.: 27,507**

[22] **Filed: Aug. 23, 1994**

[51] **LOC (6) Cl. .... 26-04**

[52] **U.S. Cl. .... D26/4**

[58] **Field of Search** ..... D26/1, 2, 3, 4;  
362/806, 808, 122, 124; 313/315, 317,  
318, 115, 116; D11/108

[56] **References Cited**

**U.S. PATENT DOCUMENTS**

D. 94,889 3/1935 Graf ..... 26/4  
D. 96,362 2/1935 Abramson ..... D26/4

D. 101,217 9/1936 Graf ..... D26/4  
D. 121,522 7/1940 Petry ..... D26/4  
D. 178,088 6/1956 Roth ..... D26/4  
2,136,780 11/1938 Berwick ..... D26/4

*Primary Examiner*—Marcus A. Jackson  
*Attorney, Agent, or Firm*—Abelman, Frayne & Schwab

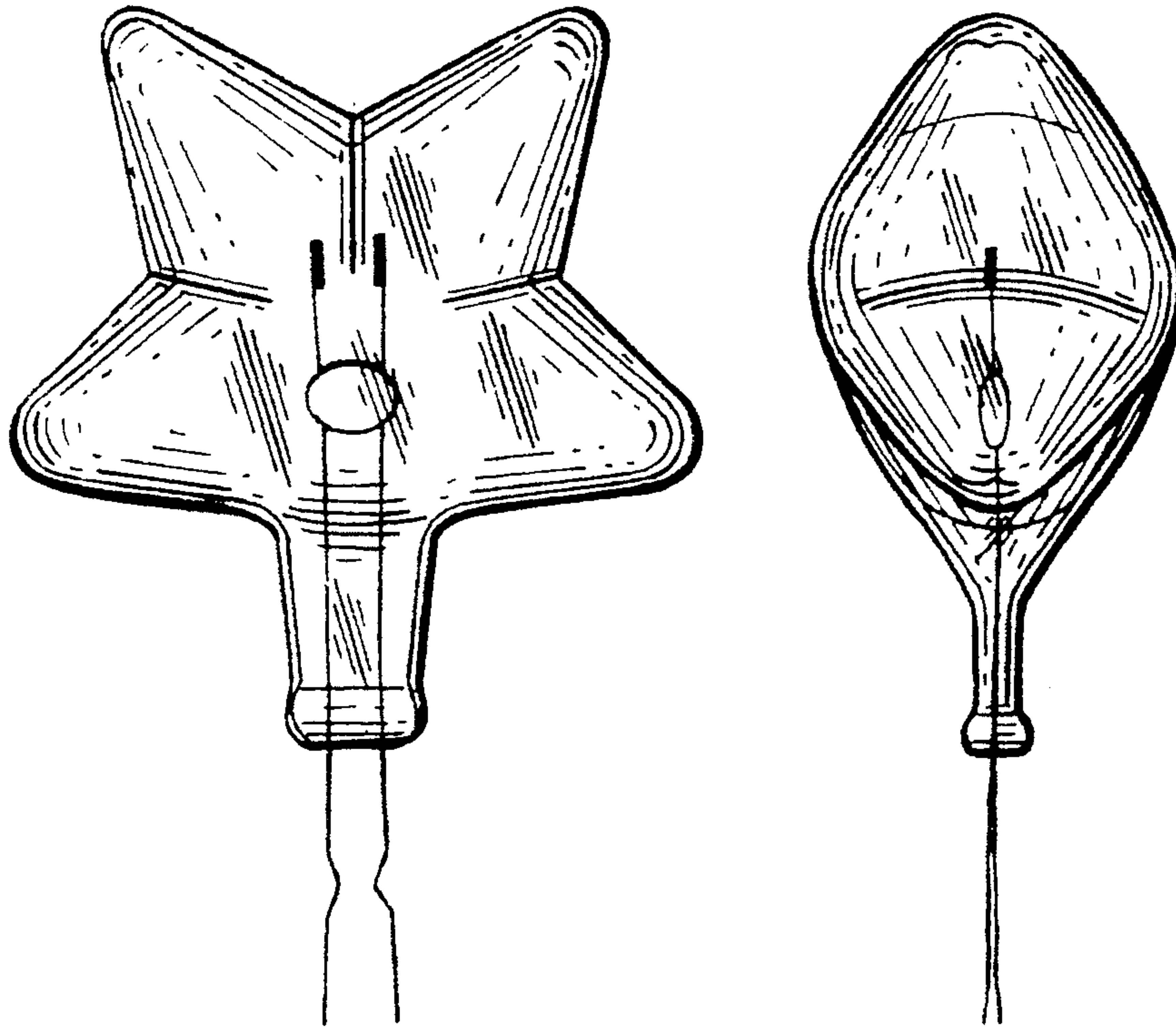
[57] **CLAIM**

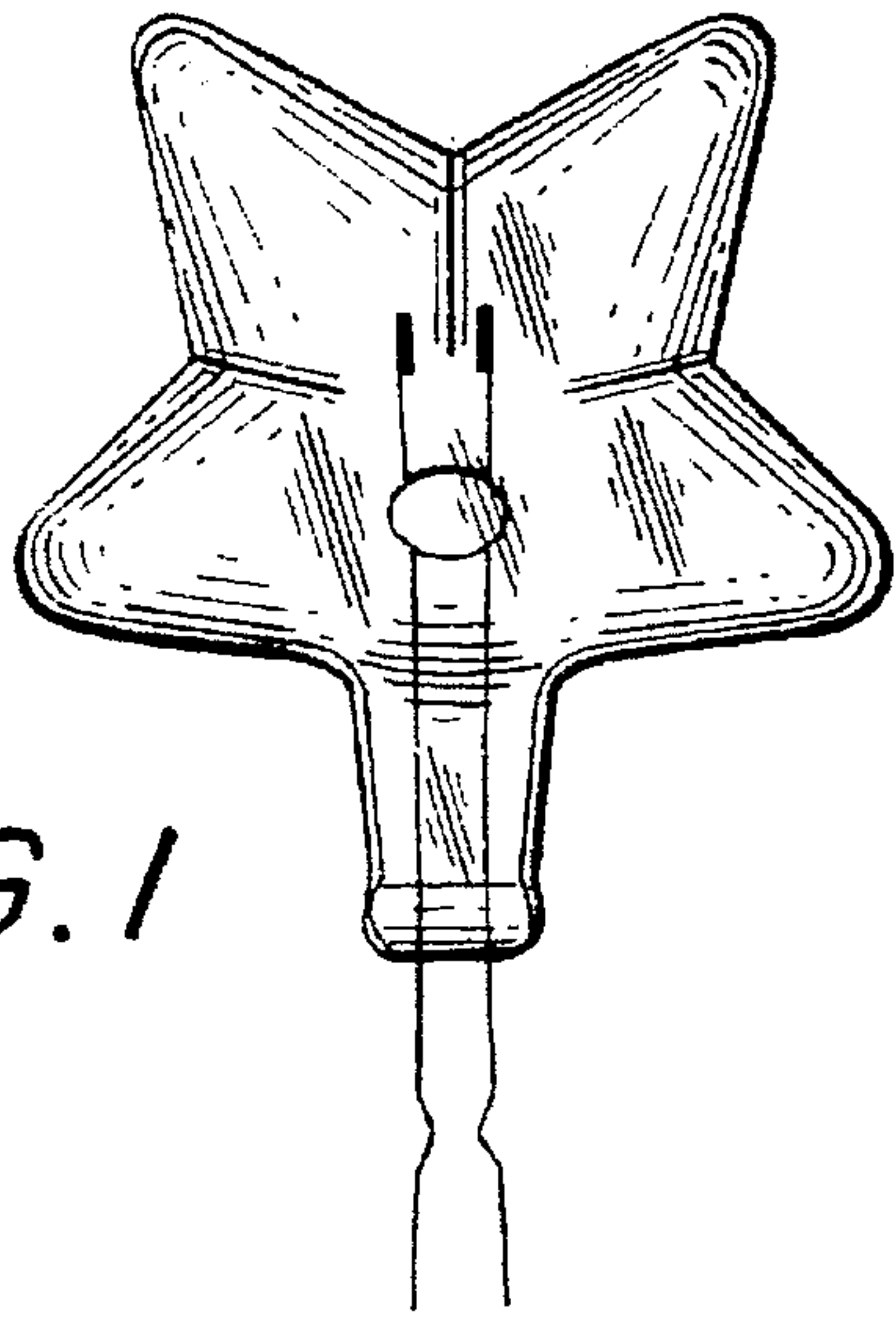
The ornamental design for a star-shaped light bulb, as shown and described.

**DESCRIPTION**

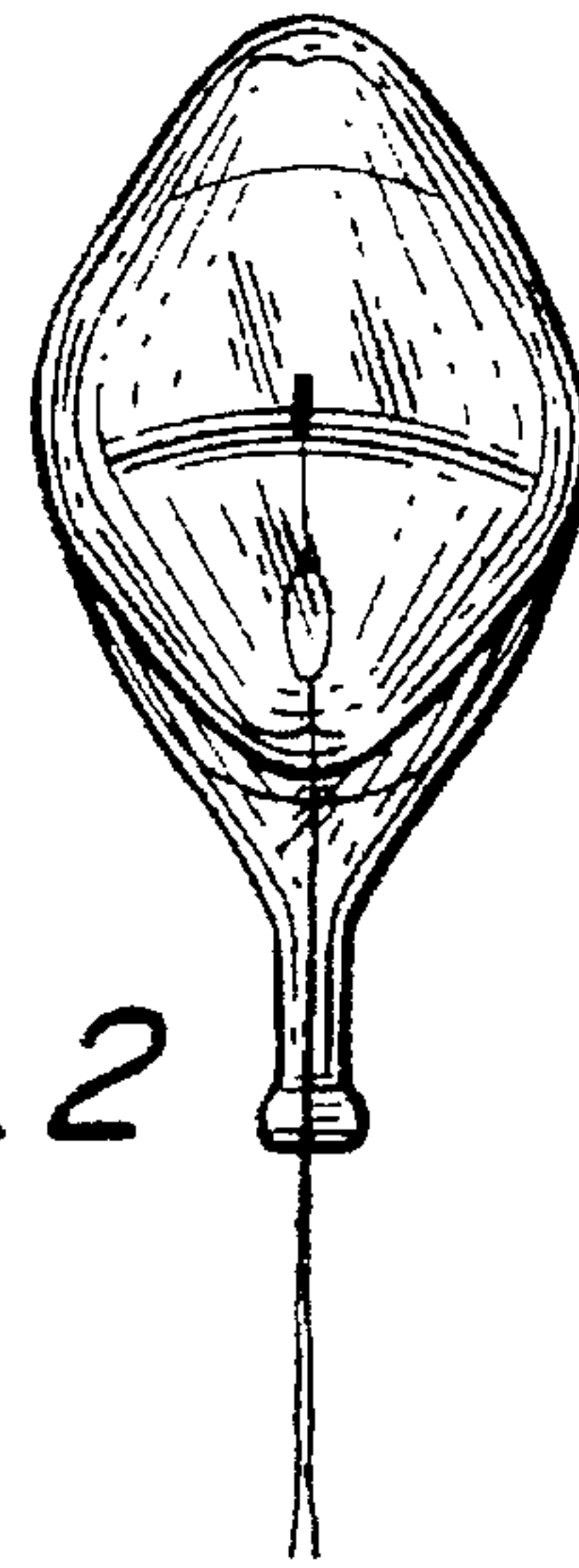
FIG. 1 is a front elevational view of a star-shaped light bulb showing my new design;  
FIG. 2 is a right-hand elevation thereof;  
FIG. 3 is a top plan view thereof;  
FIG. 4 is a bottom plan view thereof;  
FIG. 5 is a left-hand side view thereof; and,  
FIG. 6 is a rear view thereof.

**1 Claim, 1 Drawing Sheet**

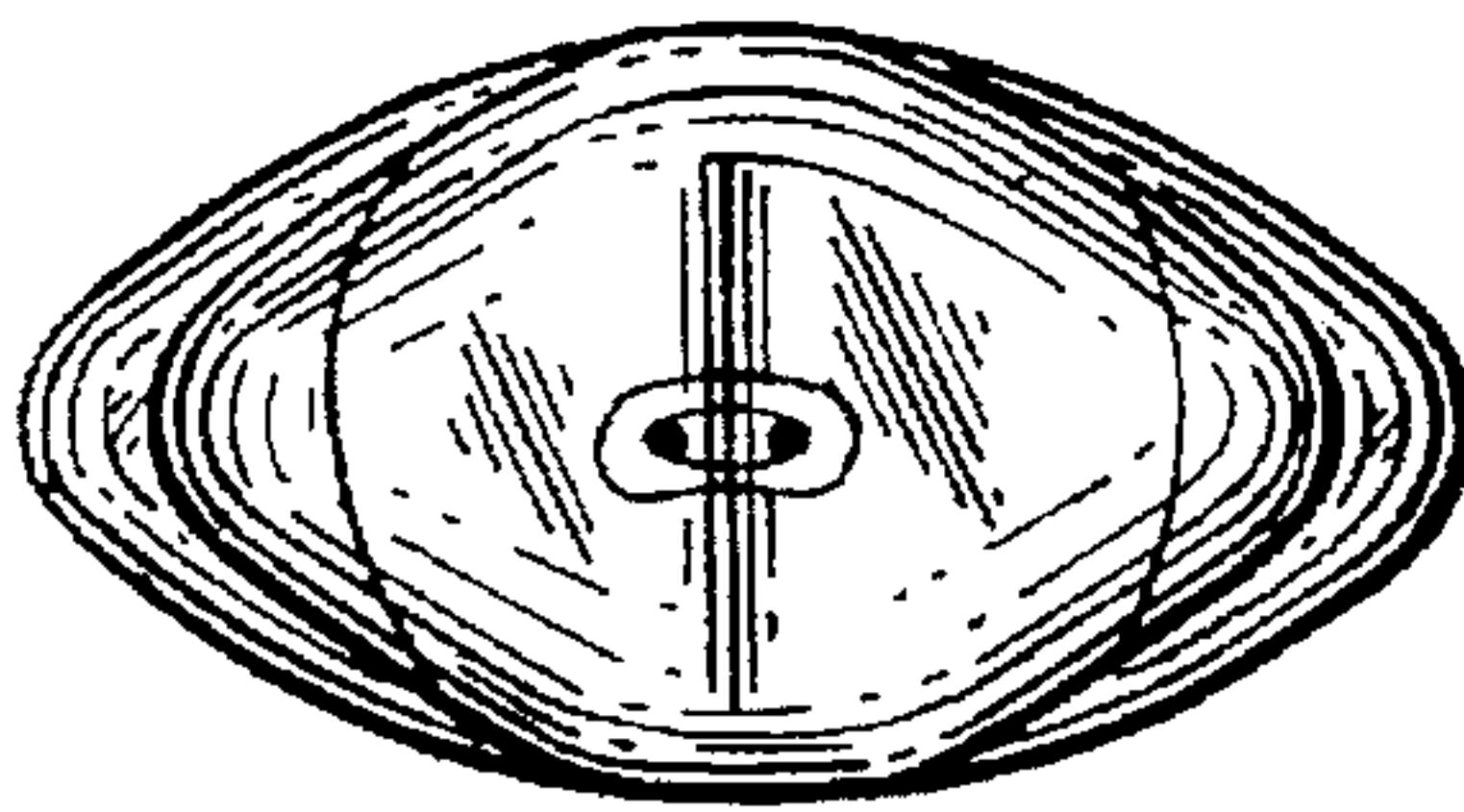




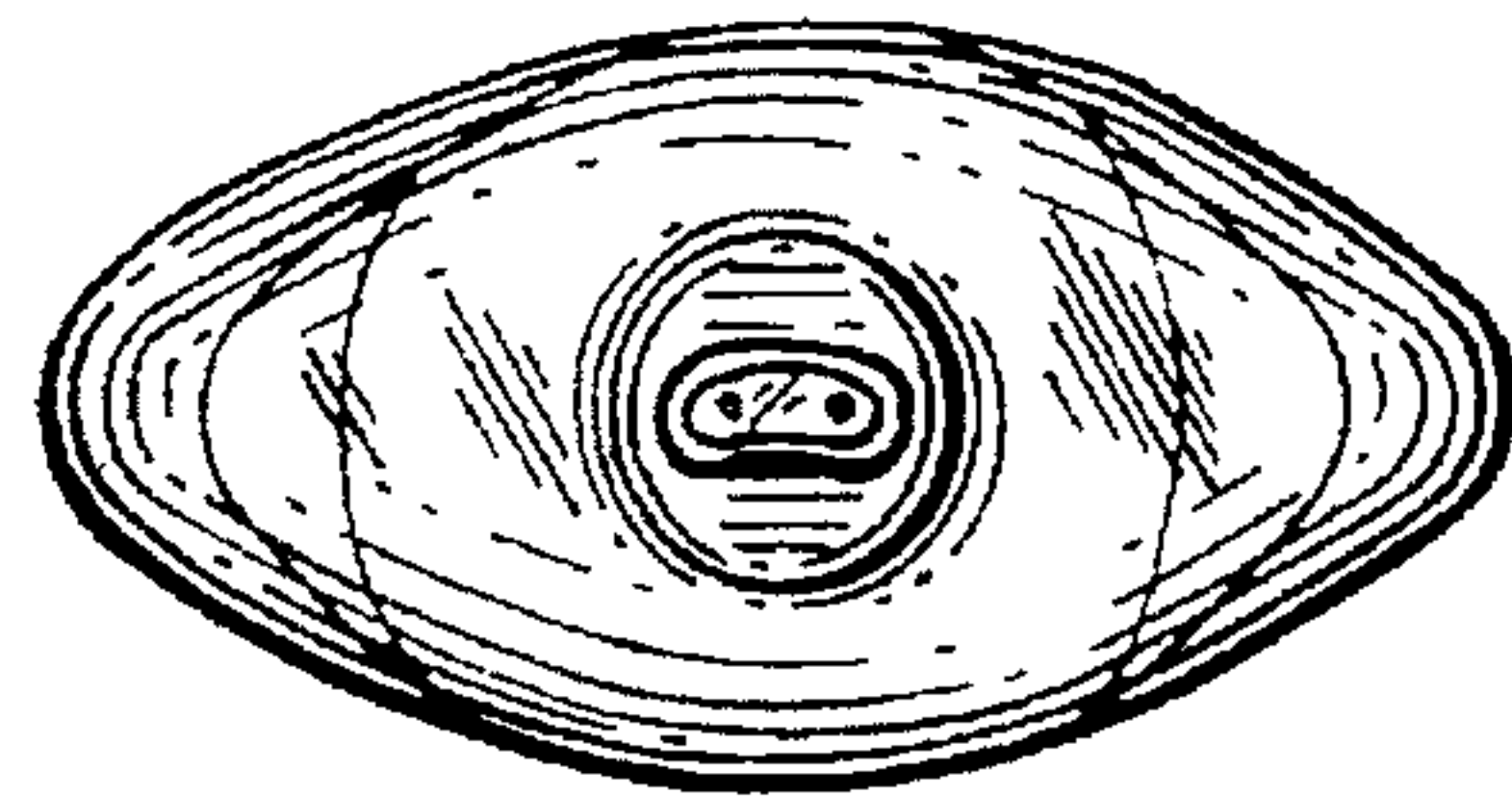
*FIG. 1*



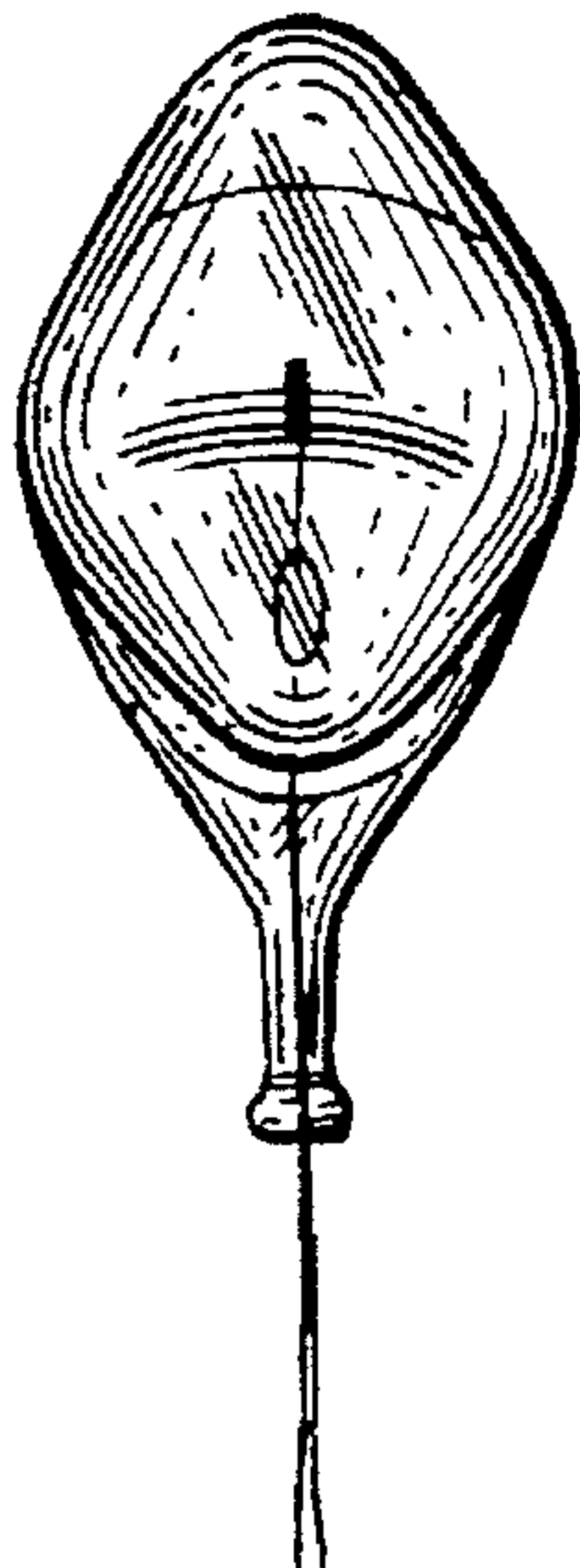
*FIG. 2*



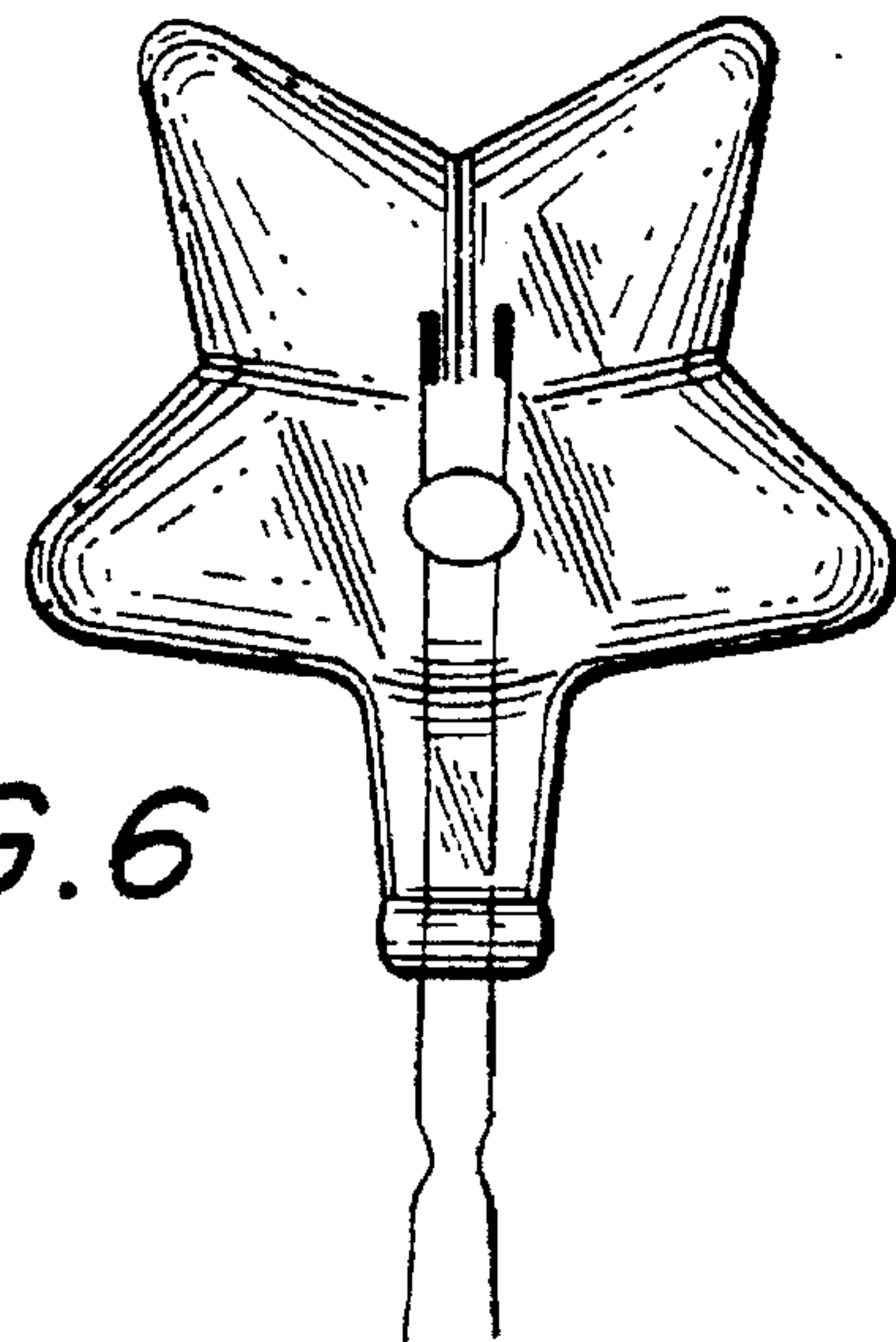
*FIG. 3*



*FIG. 4*



*FIG. 5*



*FIG. 6*