



US00D381364S

# United States Patent [19]

Schmertmann et al.

[11] Patent Number: **Des. 381,364**

[45] Date of Patent: **\*\*Jul. 22, 1997**

[54] **DESKTOP STORAGE ENCLOSURE**

[75] Inventors: **Neil Johan Schmertmann**, Boynton Beach, Fla.; **David Townsend**, Dublin, Ireland; **Robert Kurchart**, Boca Raton, Fla.

[73] Assignee: **Motorola, Inc.**, Schaumburg, Ill.

[\*\*] Term: **14 Years**

[21] Appl. No.: **53,407**

[22] Filed: **Apr. 22, 1996**

[51] LOC (6) Cl. .... **19-02**

[52] U.S. Cl. .... **D19/92; D19/75; D19/86; D19/95**

[58] Field of Search ..... D19/65, 75, 78, D19/86, 92, 95, 99, 100; 206/215, 371, 425, 505, 511, 555; 211/10, 11, 13, 45, 50, 55, 126

[56] **References Cited**

**U.S. PATENT DOCUMENTS**

D. 192,277 2/1962 Meyer ..... D19/92 X

D. 192,584	4/1962	Wassmann	.....	D19/92
D. 197,870	3/1964	Wildgen	.....	D19/92
D. 256,852	9/1980	McGahee	.....	D3/247
D. 269,657	7/1983	Taylor	.....	D6/510
D. 273,259	4/1984	Gullett	.....	D19/92 X
D. 334,412	3/1993	Feer	.....	D19/92
4,478,339	10/1984	Herr et al.	.....	211/126

*Primary Examiner*—Martie Thompson  
*Attorney, Agent, or Firm*—Keith A. Chanroo

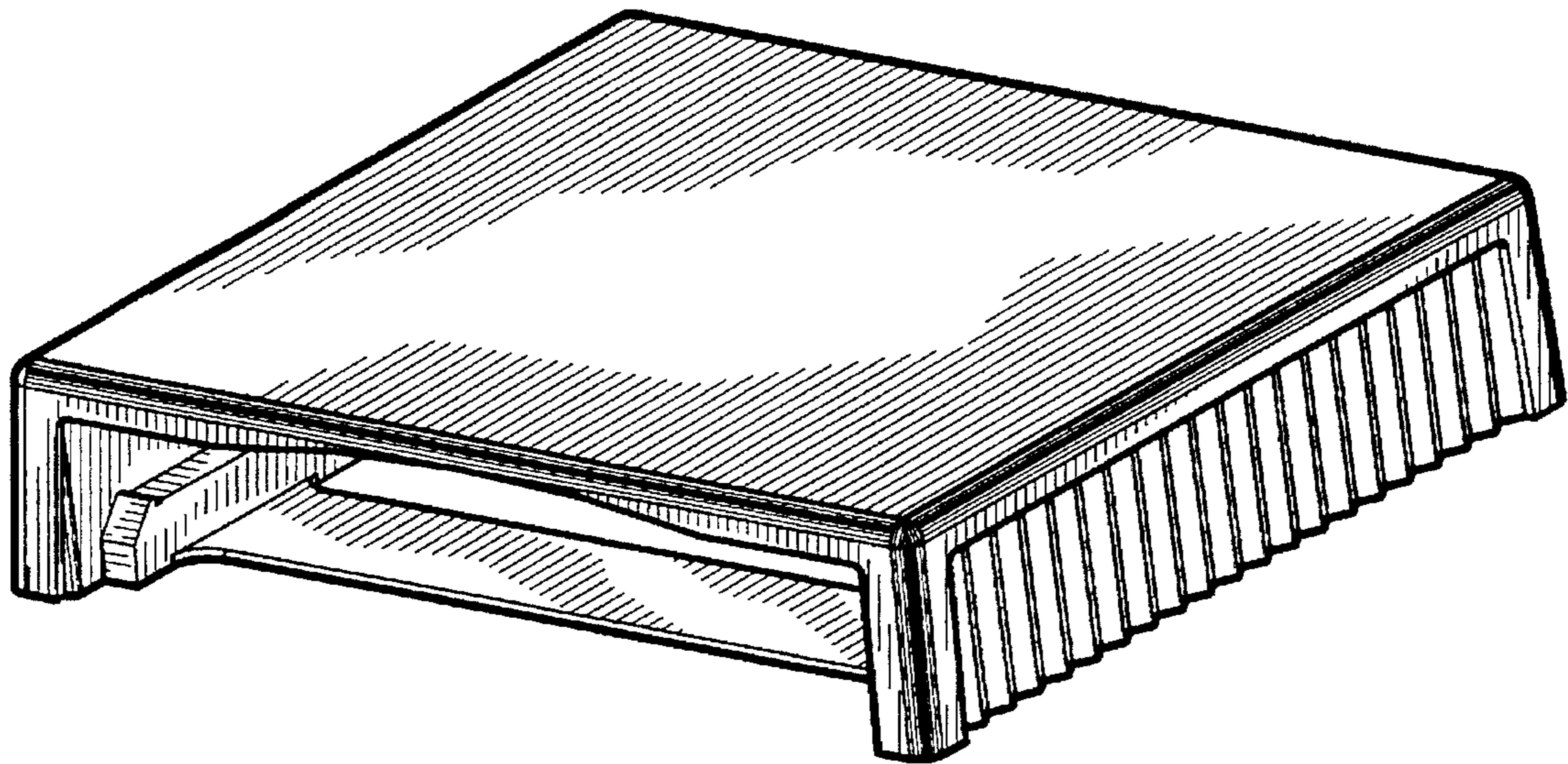
[57] **CLAIM**

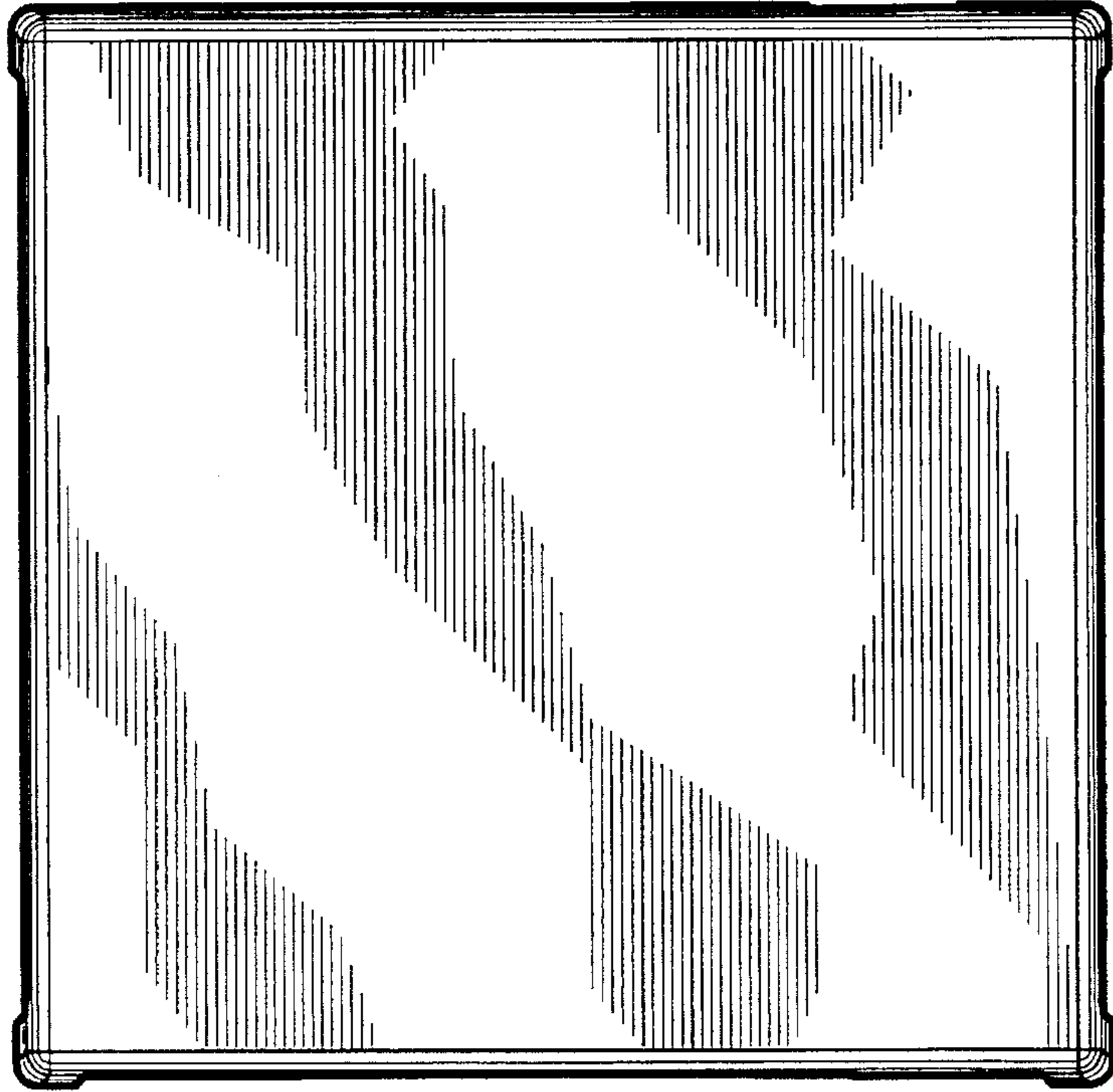
The ornamental design for a "Desktop Storage Enclosure" as shown and described.

**DESCRIPTION**

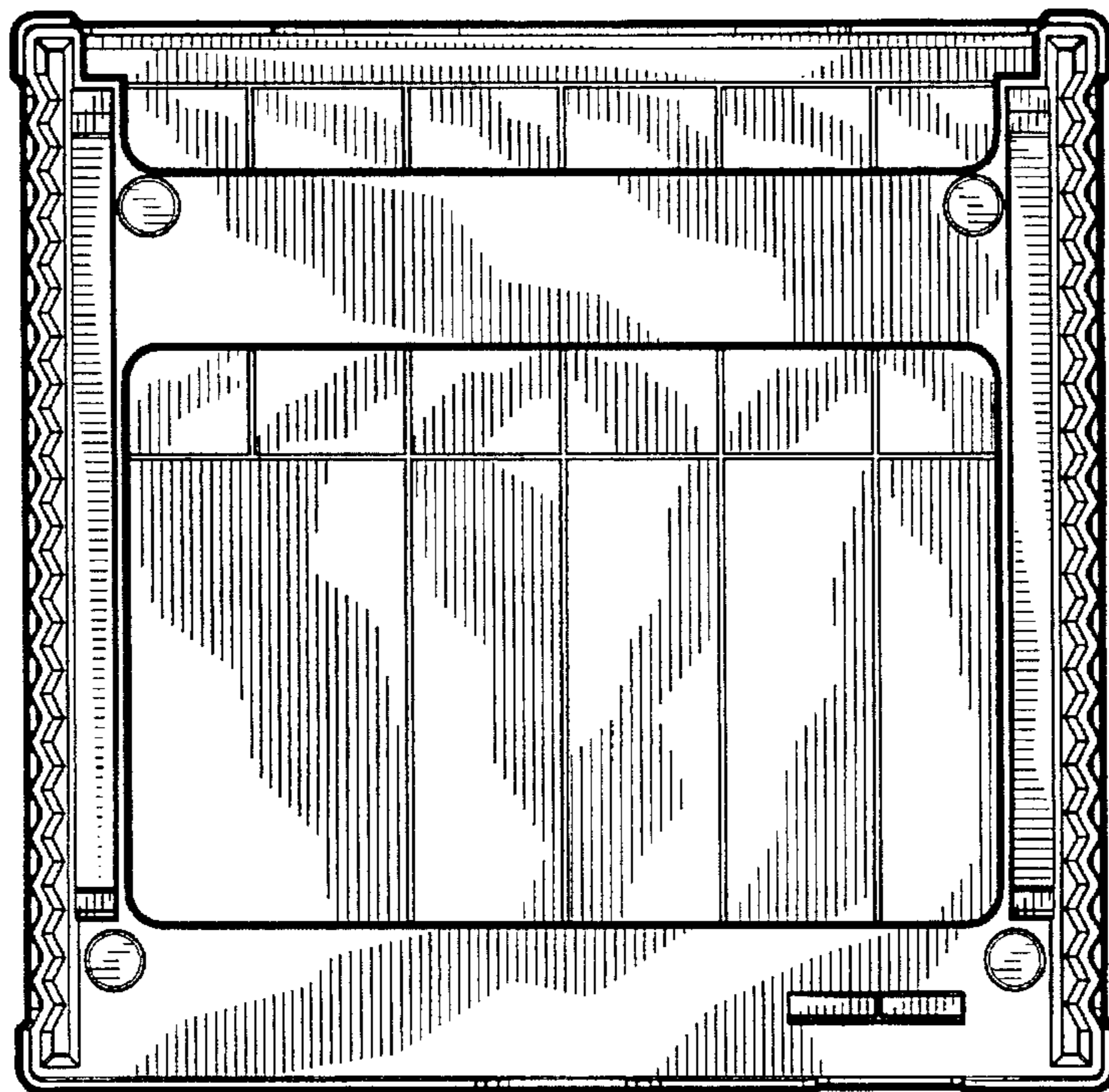
FIG. 1 is a top plan view of a "Desktop Storage Enclosure" showing our new design;  
FIG. 2 is a bottom plan view thereof;  
FIG. 3 is a left side view thereof;  
FIG. 4 is a right side view thereof;  
FIG. 5 is a front elevation view thereof;  
FIG. 6 is a rear elevation view thereof;  
FIG. 7 is a perspective view thereof; and  
FIG. 8 is an exploded perspective view thereof.

**1 Claim, 4 Drawing Sheets**

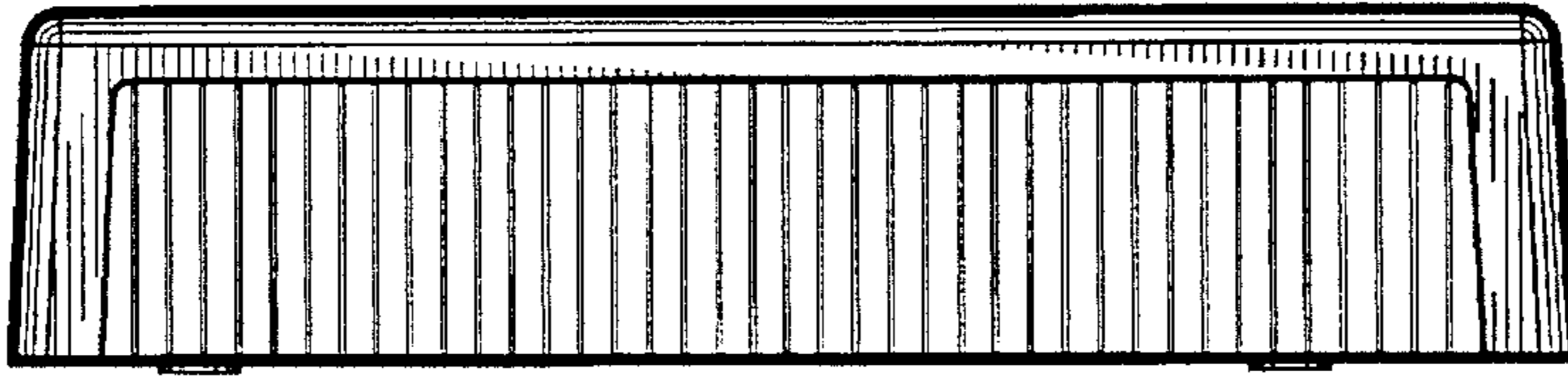




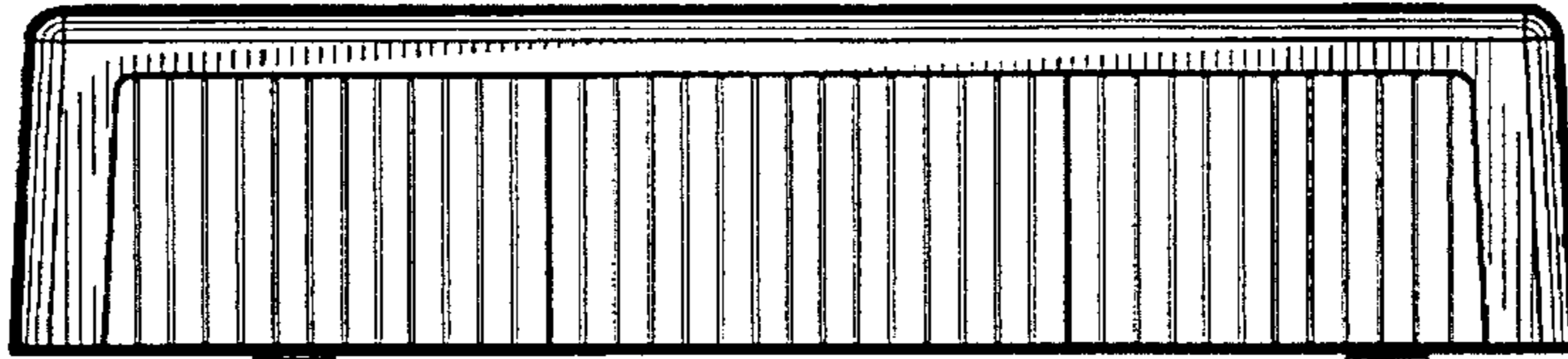
*FIG. 1*



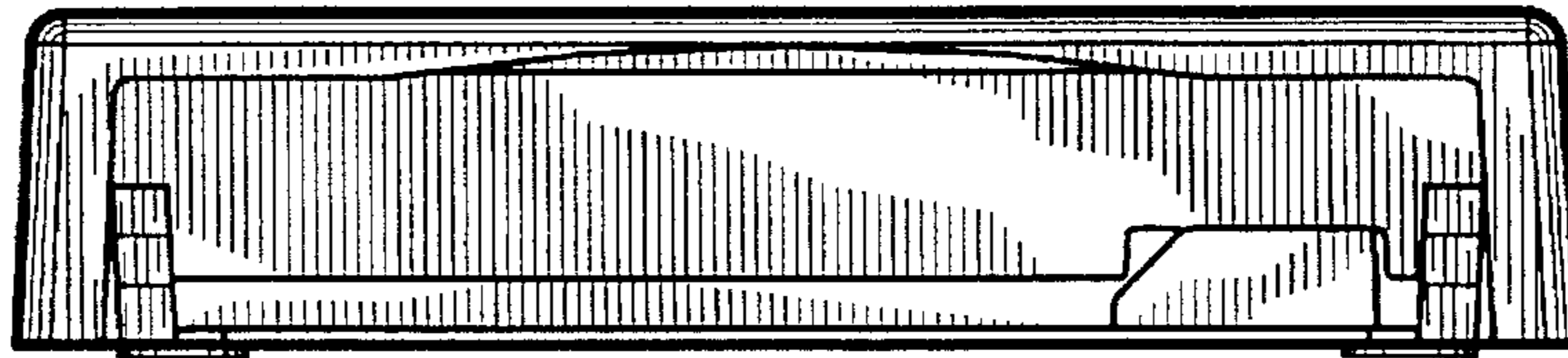
*FIG. 2*



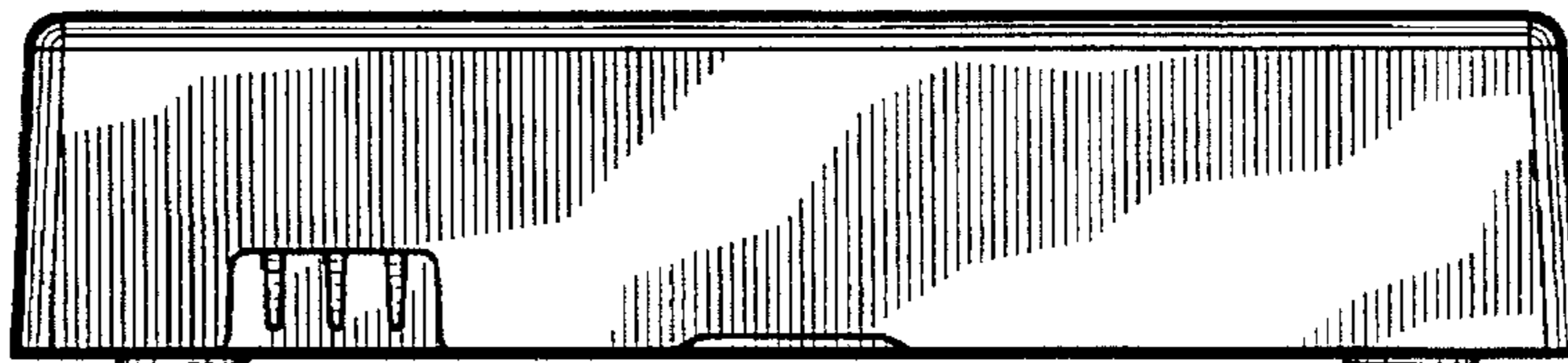
*FIG. 3*



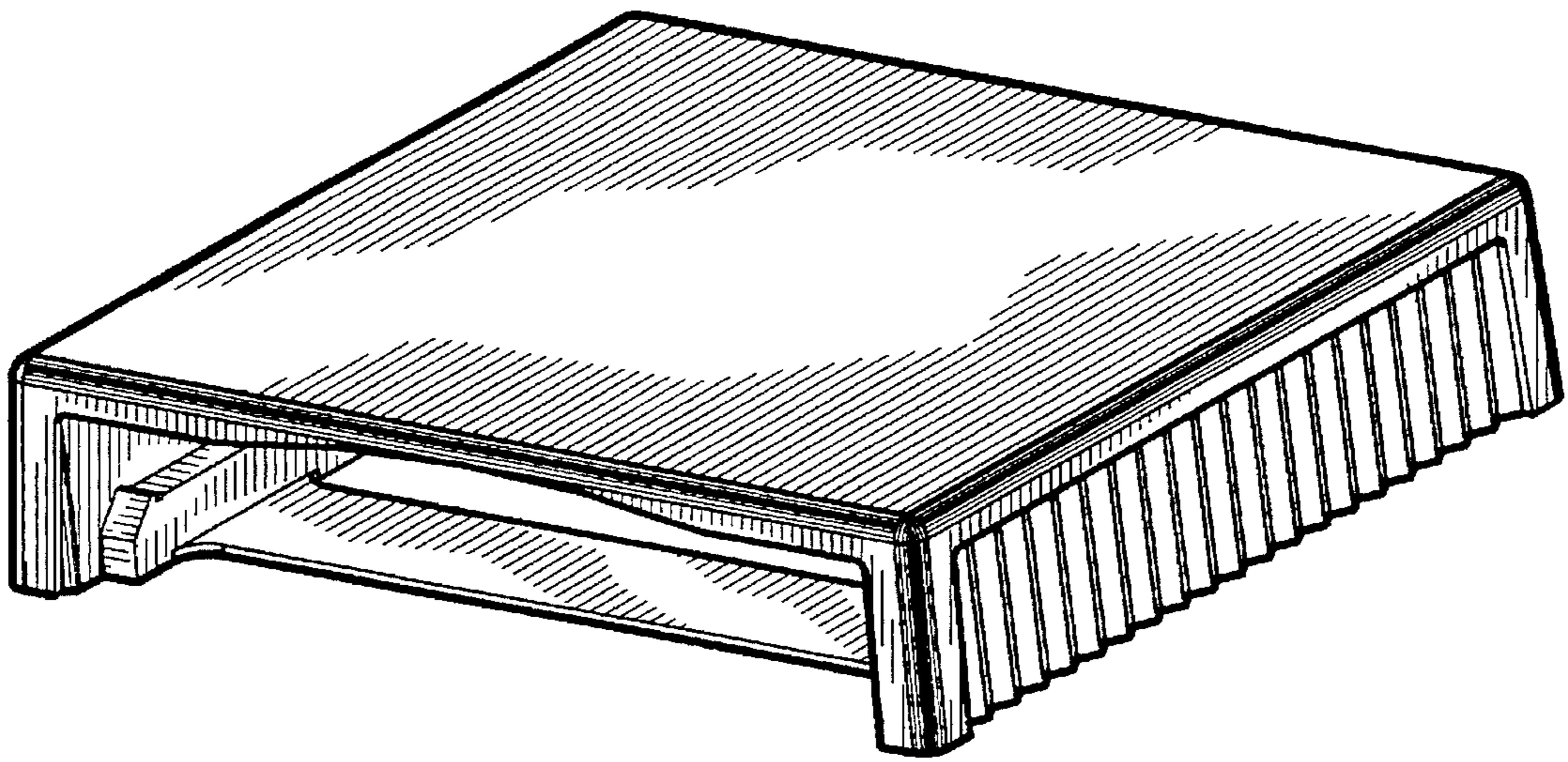
*FIG. 4*



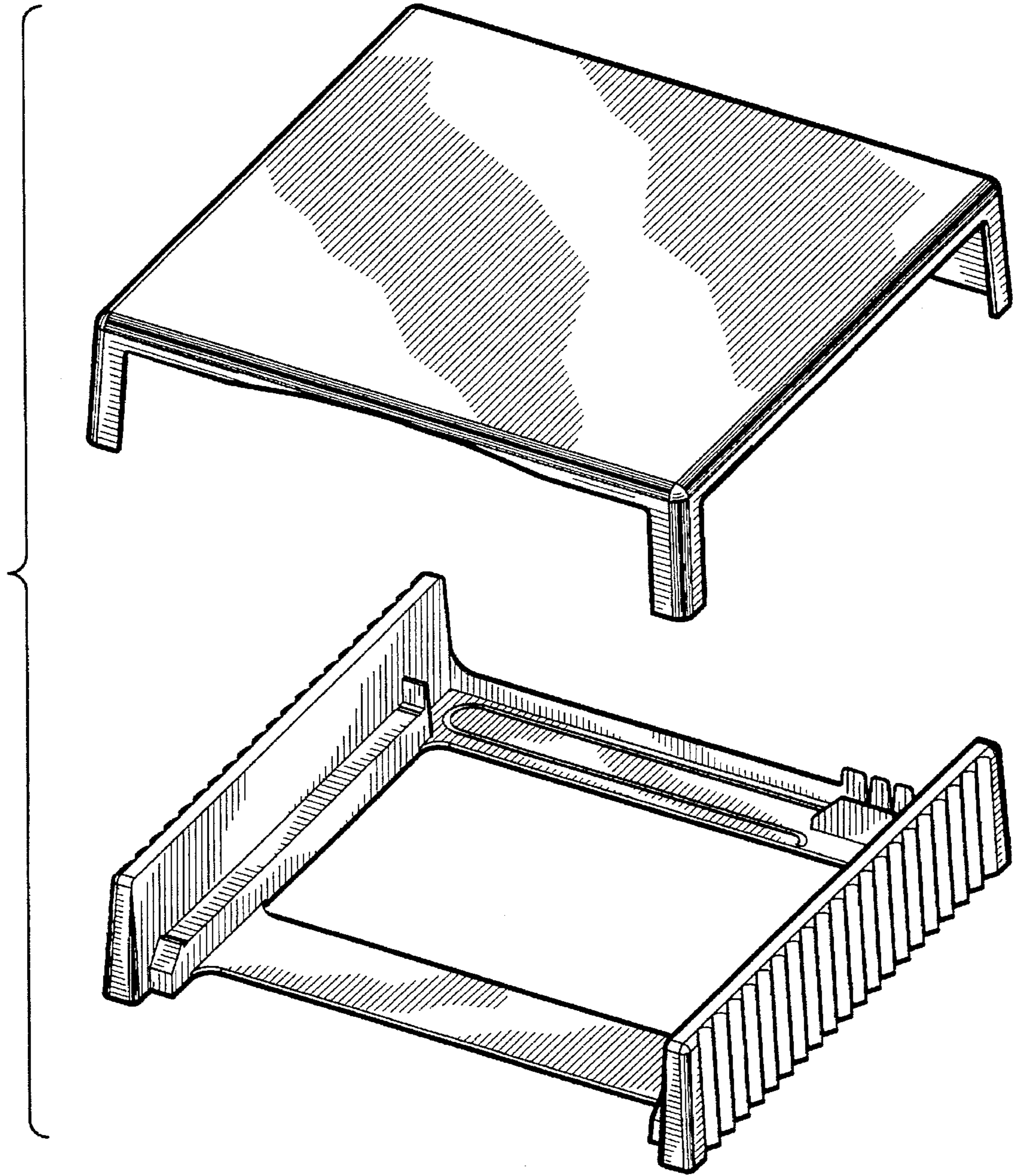
*FIG. 5*



*FIG. 6*



*FIG. 7*



*FIG. 8*