



US00D381307S

# United States Patent [19]

[11] Patent Number: **Des. 381,307**

Gwynn et al.

[45] Date of Patent: **\*\*Jul. 22, 1997**

[54] **REAR WINDOW LICENSE PLATE HOLDER WITH SWIVELLING SUCTION CUP ATTACHMENT MEMBERS**

2,192,561 3/1940 Seeley ..... 40/209

*Primary Examiner*—Louis S. Zarfes  
*Assistant Examiner*—Frank Martinez

[76] Inventors: **Sheldon Patrick Gwynn; Keith Vanzant**, both of 8201 Stout, Detroit, Mich. 48228

[57] **CLAIM**

[\*\*] Term: **14 Years**

The ornamental design for a rear window license plate holder with swivelling suction cup attachment members, as shown and described.

[21] Appl. No.: **48,796**

**DESCRIPTION**

[22] Filed: **Dec. 22, 1995**

FIG. 1 is a front elevational view of the rear window license plate holder with swivelling suction cup attachment members showing our new design;

[51] LOC (6) Cl. .... **12-16**

[52] U.S. Cl. .... **D12/193**

FIG. 2 is a rear elevational view thereof;

[58] Field of Search ..... D12/193; D20/13;

FIG. 3 is a right view thereof;

D6/300, 310, 303, 306; 40/200, 209, 211, 204

FIG. 4 is a left view thereof;

FIG. 5 is a top plan view thereof;

FIG. 6 is a bottom plan view thereof; and,

FIG. 7 is an isometric view thereof.

The broken line showing of vehicle license plate is for illustrative purposes only and forms no part of the claimed design.

[56] **References Cited**

**U.S. PATENT DOCUMENTS**

D. 49,354	7/1916	Ilch	.....	D12/191
D. 182,783	5/1958	Audette	.....	D12/193
D. 311,164	10/1990	Douglas	.....	D12/191
D. 350,104	8/1994	Lee	.....	D12/193

**1 Claim, 3 Drawing Sheets**

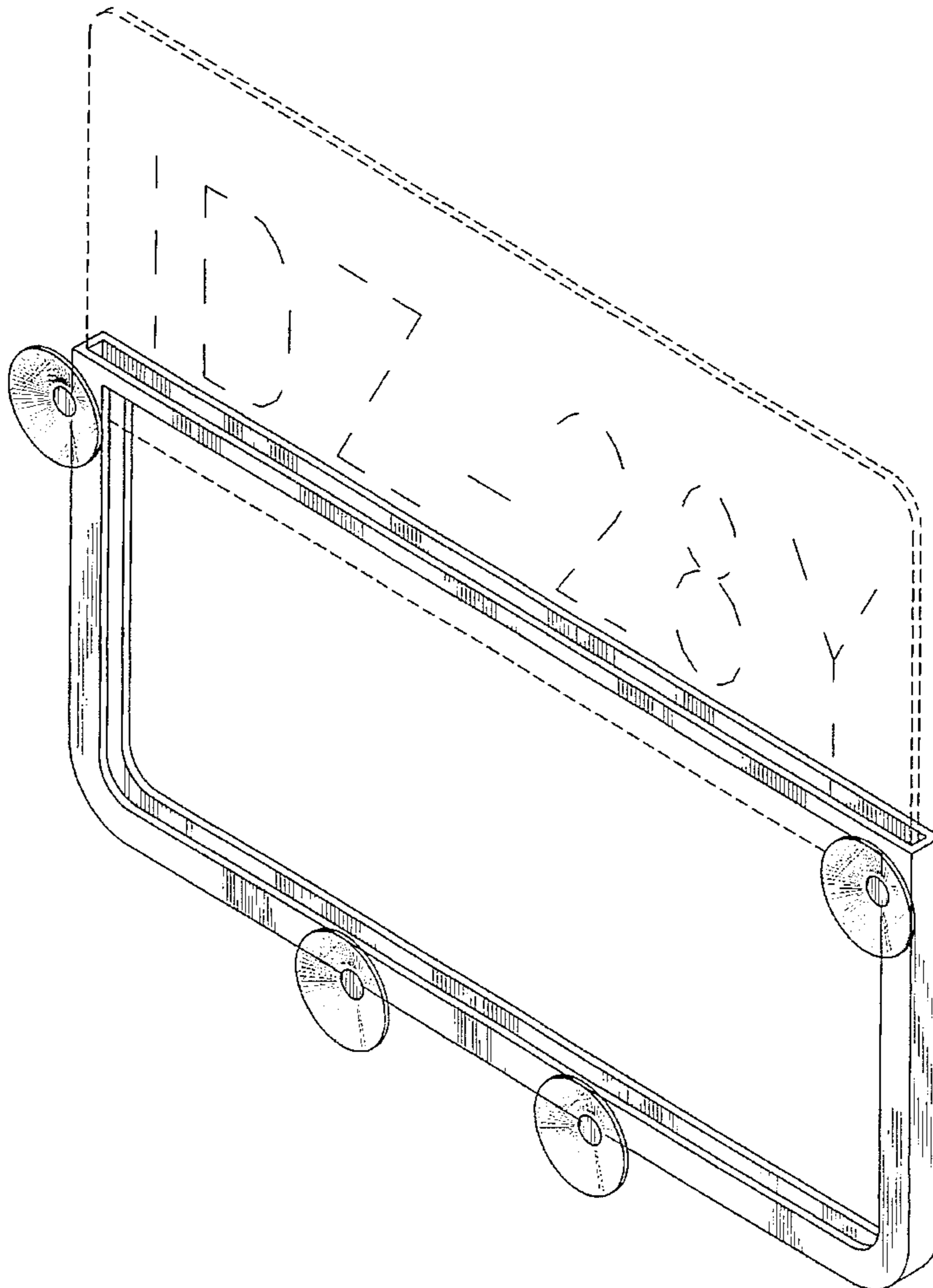

FIG. 1

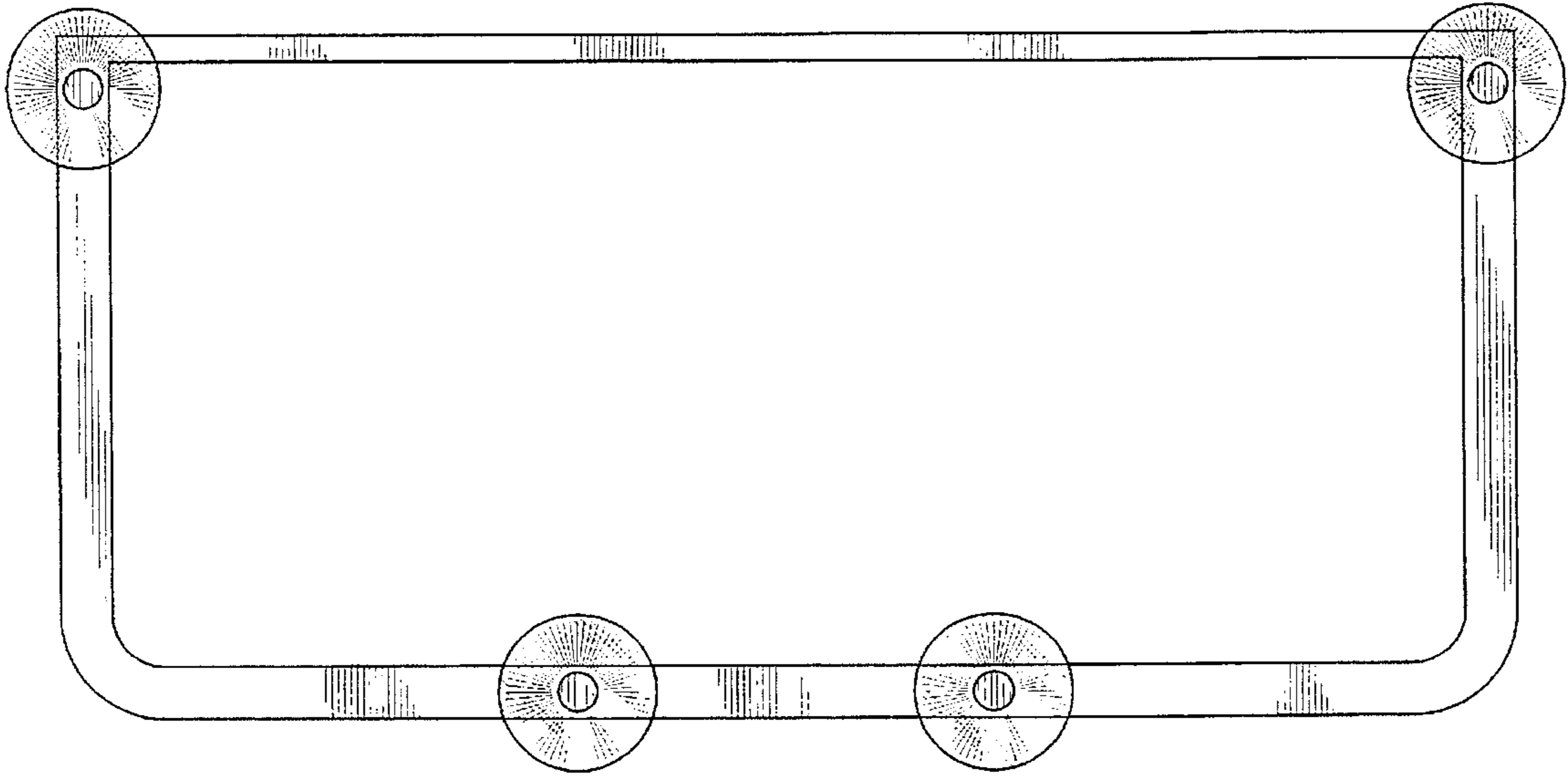

FIG. 2

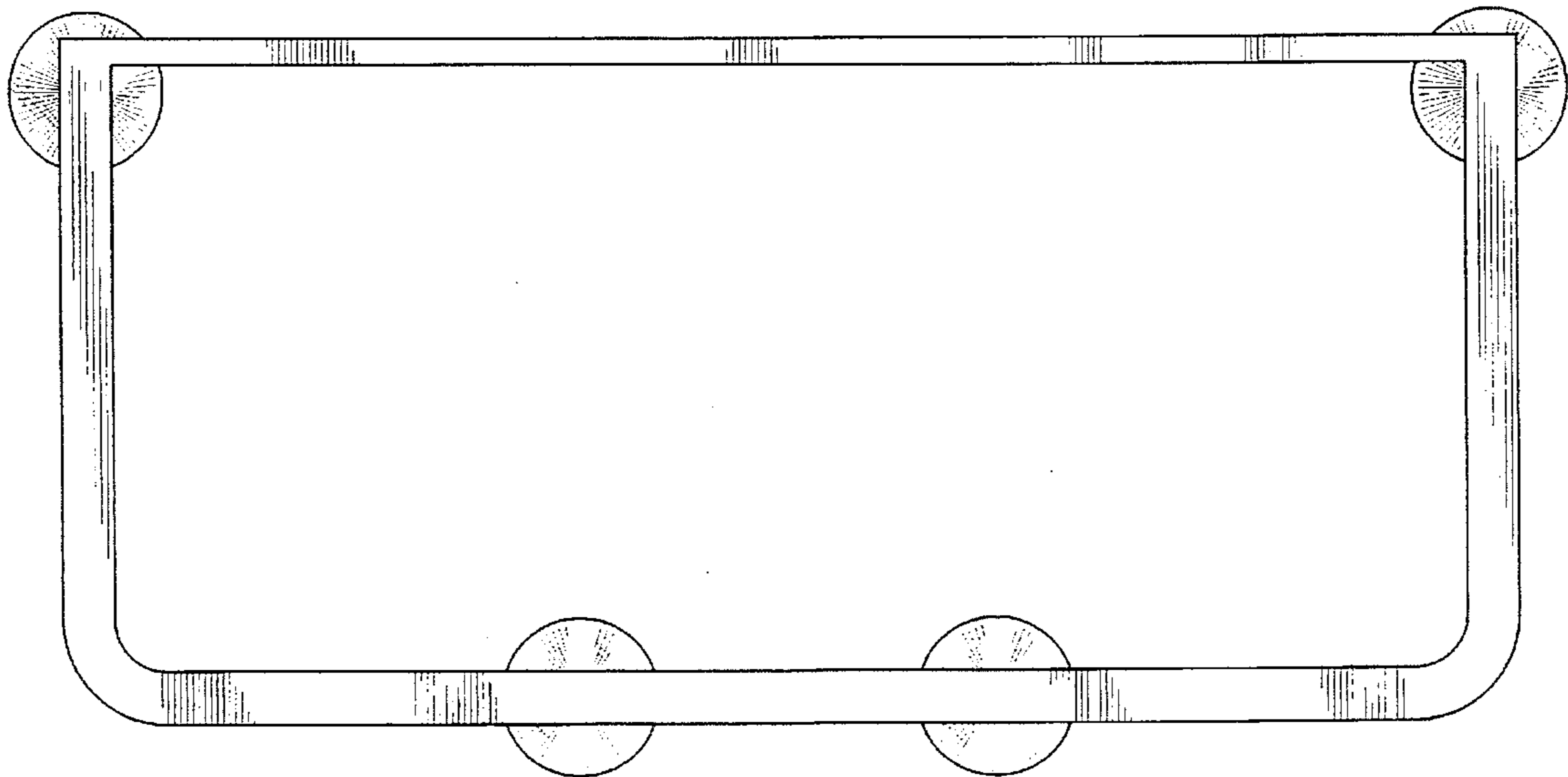

FIG. 3

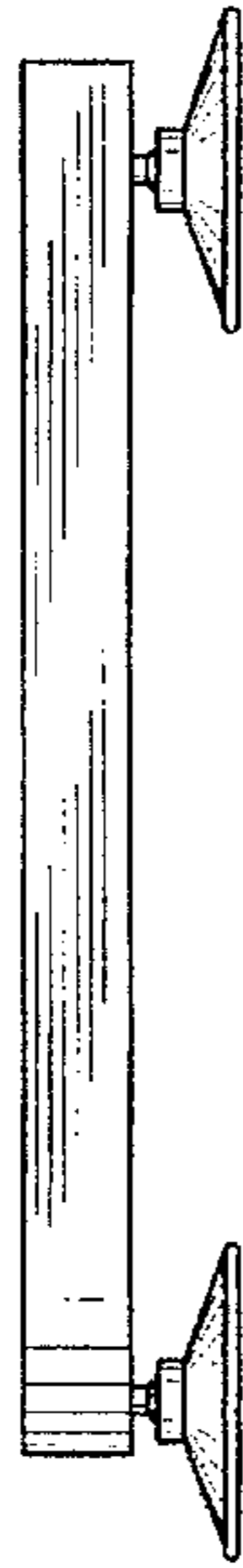

FIG. 4

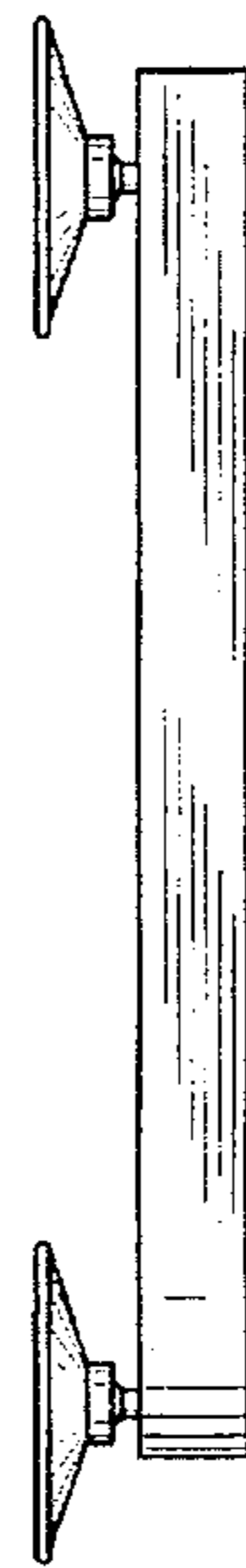

FIG. 5

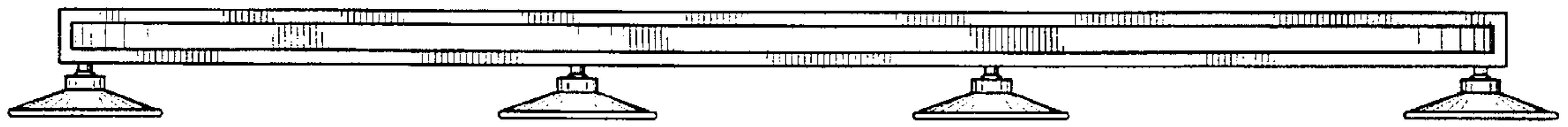

FIG. 6



FIG. 7

