



US00D381235S

United States Patent [19]
Bangert

[11] **Patent Number: Des. 381,235**
[45] **Date of Patent: **Jul. 22, 1997**

[54] **COMPACT DISC HOLDER**

[76] **Inventor: Peter Bangert, Ludwig-Thoma Weg**
19a, 83684 Tegernsee-Süd, BRD,
Germany

[**] **Term: 14 Years**

[21] **Appl. No.: 43,104**

[22] **Filed: Aug. 25, 1995**

[30] **Foreign Application Priority Data**

Feb. 27, 1995 [DE] Germany M 95 01 969.3

[51] **LOC (6) Cl. 06-04**

[52] **U.S. Cl. D6/629; D6/467; D6/475**

[58] **Field of Search** D6/407, 449, 427-435,
D6/475, 466, 467, 468; 206/711, 454, 445,
307.1, 308.1, 308.3, 387.1, 387.15; 211/40-42;
269/903; 312/9.1, 9.9, 9.16, 9.45, 9.46,
9.48, 9.53, 9.56, 9.51, 9.52, 9.55; D3/313,
315; D8/71; D13/182; D9/341; D15/140

[56] **References Cited**

U.S. PATENT DOCUMENTS

Re. 33,361 10/1990 Coe 206/711 X
D. 138,337 7/1944 Braloff D6/407

D. 270,738 9/1983 Mayo D3/313 X
D. 305,841 2/1990 Macqueen D6/475
3,939,973 2/1976 Wallestad 206/454
4,541,528 9/1985 Holmes 206/445 X
4,588,086 5/1986 Coe 206/308.3
4,743,156 5/1988 Raffay et al. 211/40 X
5,348,151 9/1994 Dressen 206/454 X
5,417,767 5/1995 Stinson 206/454 X
5,468,297 11/1995 Letort 211/41 X

Primary Examiner—Jeffrey Asch
Attorney, Agent, or Firm—Marshall, O'Toole, Gerstein,
Murray & Borun

[57] **CLAIM**

The ornamental design for a compact disc holder, as shown and described.

DESCRIPTION

FIG. 1 is a perspective view taken from above and to the right of a compact disc holder showing my new design; FIG. 2 is a top plan view thereof; FIG. 3 is a front elevational view thereof; FIG. 4 is a right side elevational view thereof; FIG. 5 is a bottom view thereof; FIG. 6 is a rear elevational view thereof; and, FIG. 7 is a left side elevational view thereof.

1 Claim, 3 Drawing Sheets

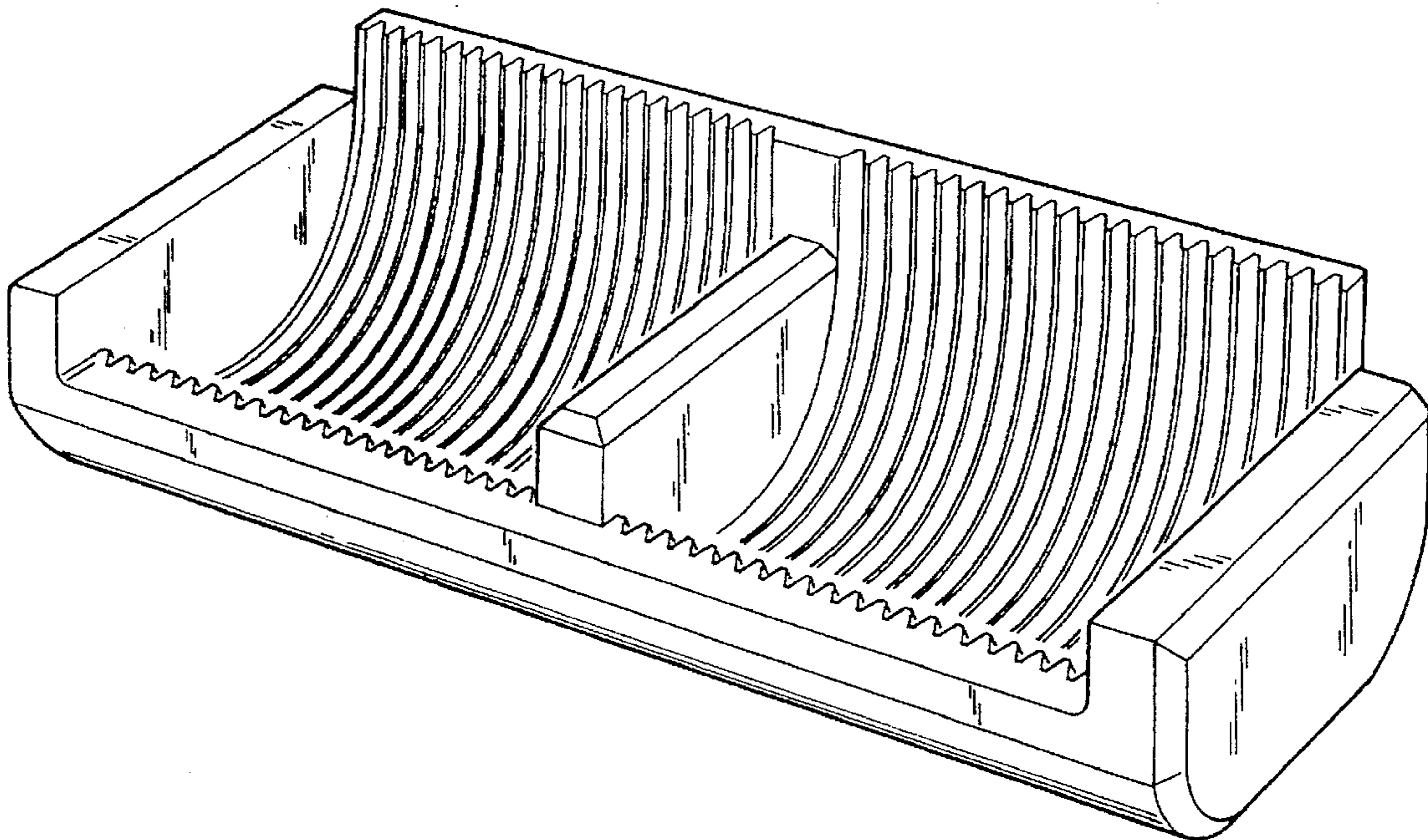

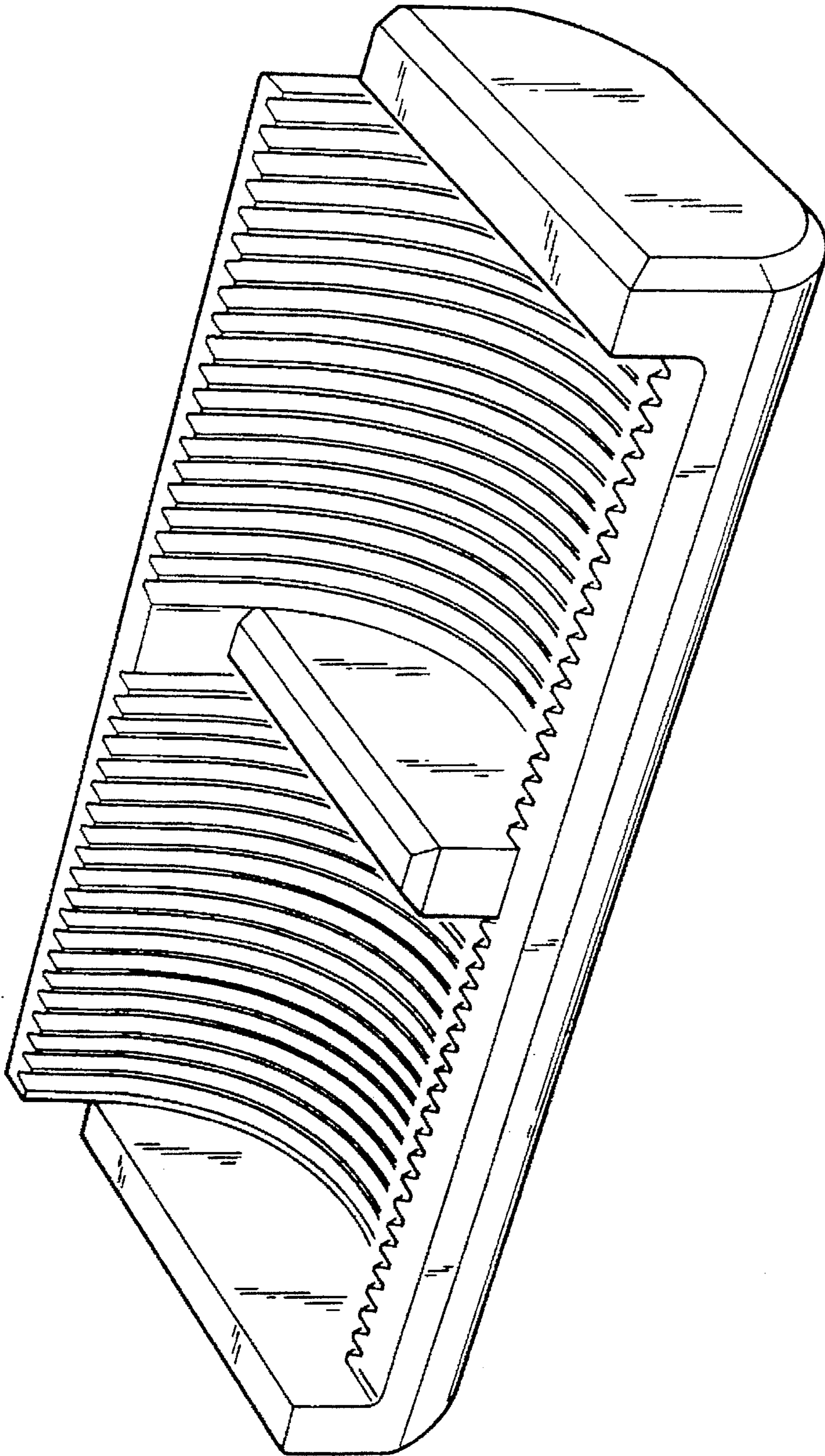

FIG. 1

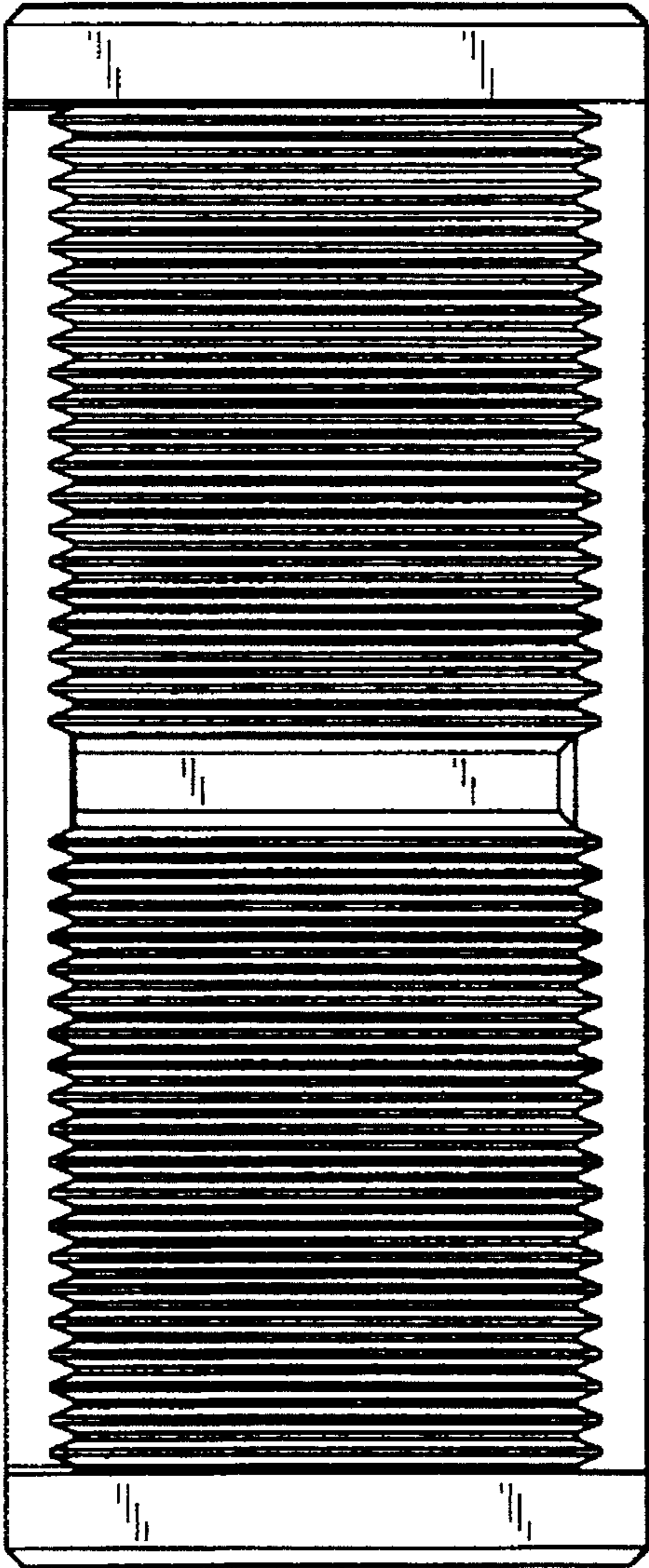

FIG. 2

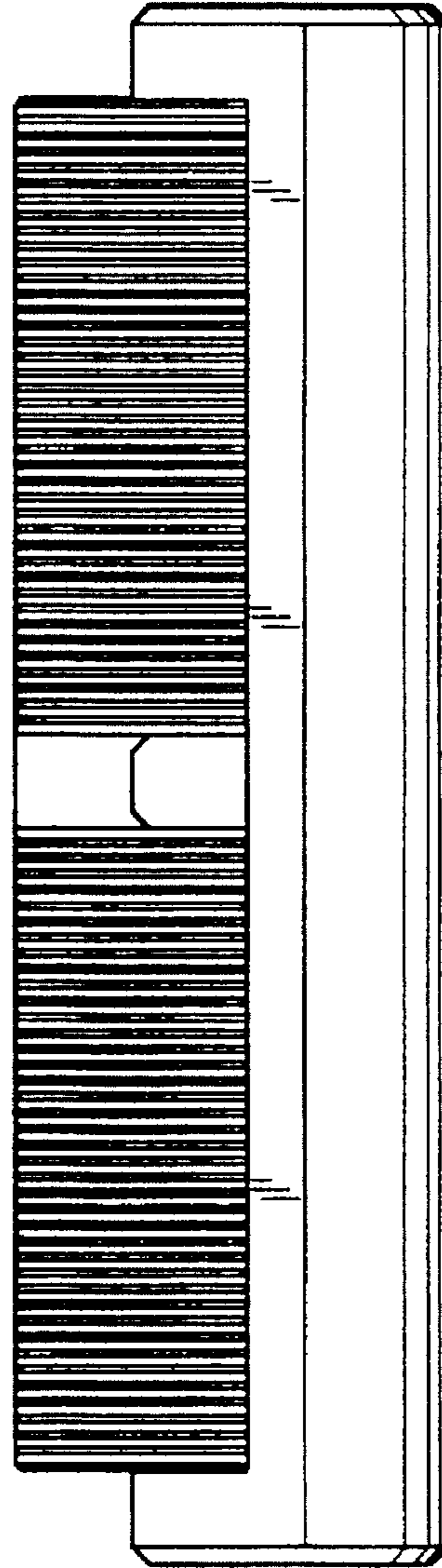

FIG. 3

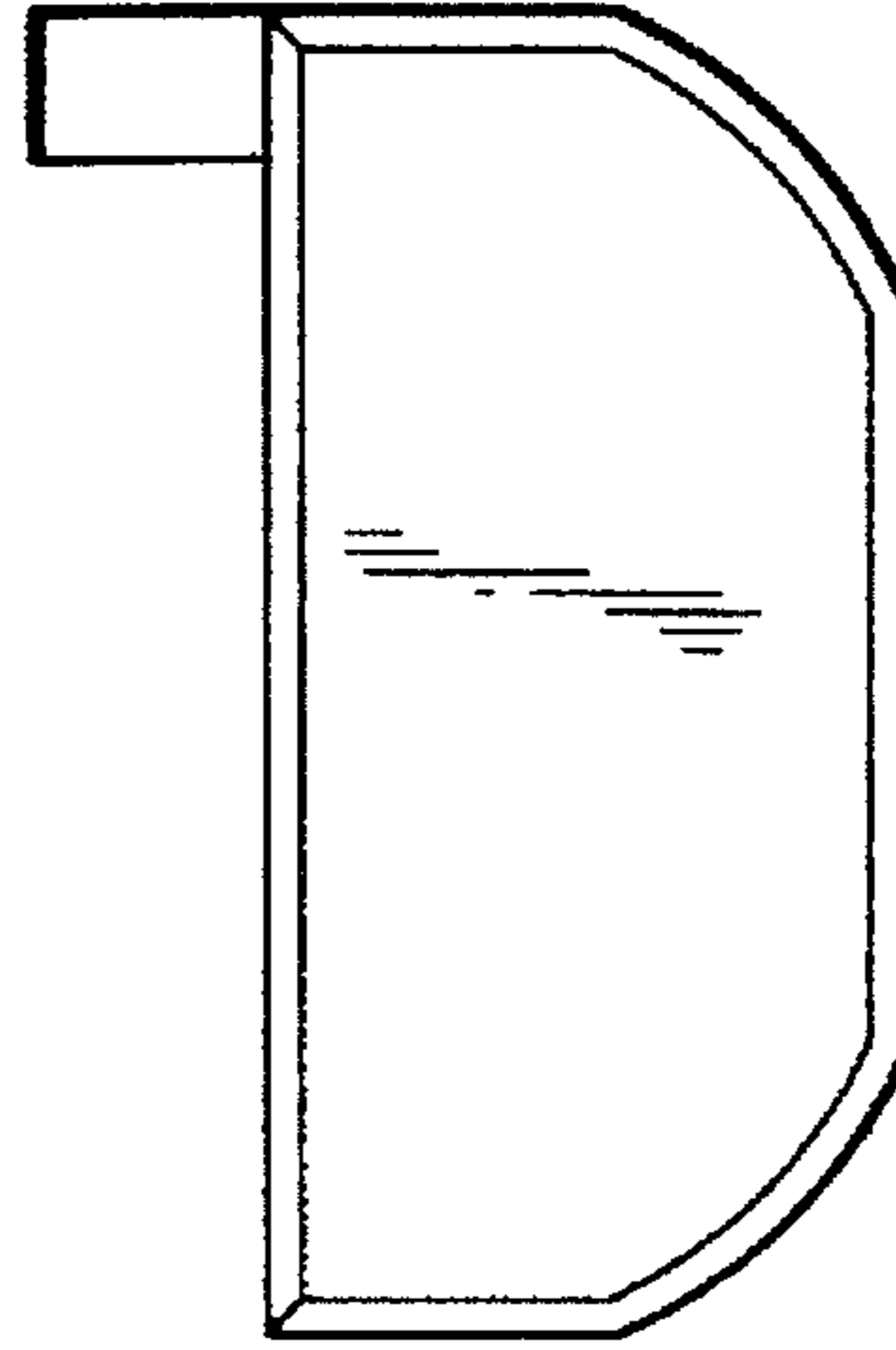

FIG. 4

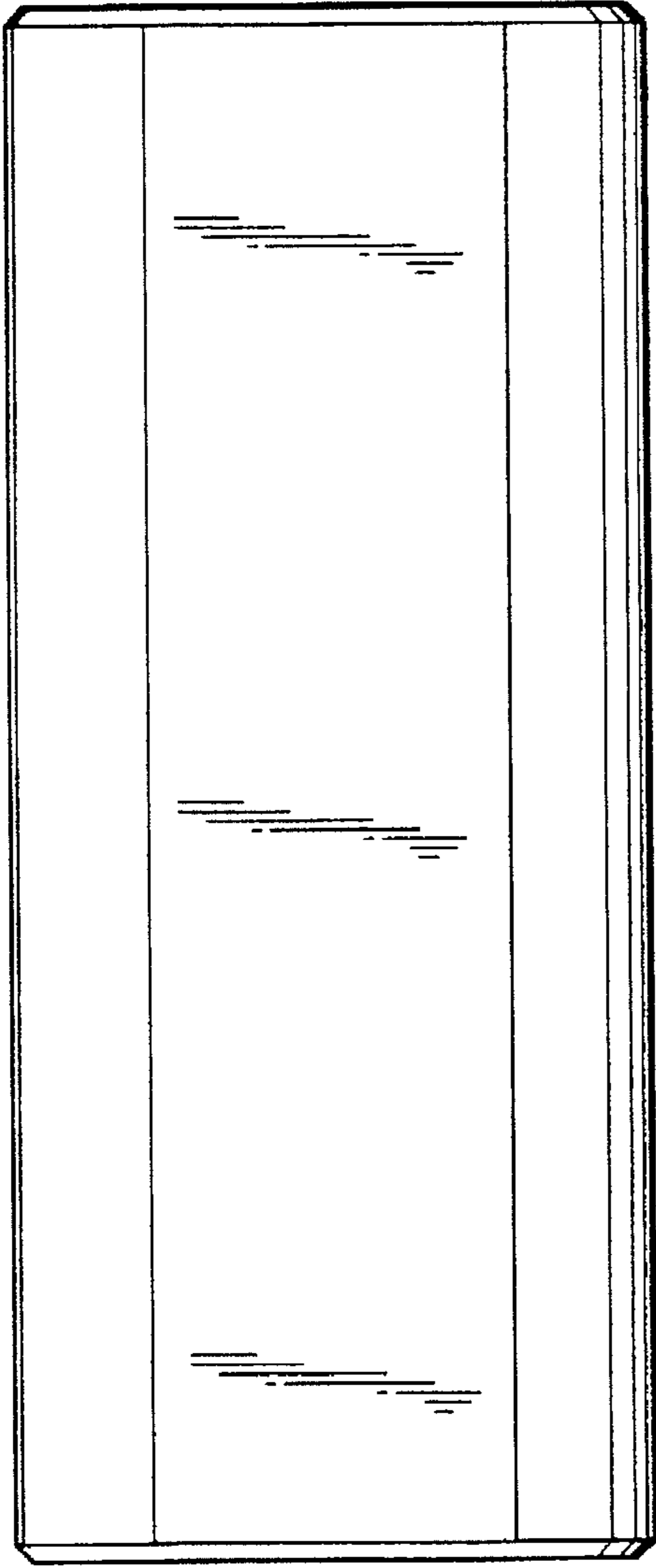

FIG. 5

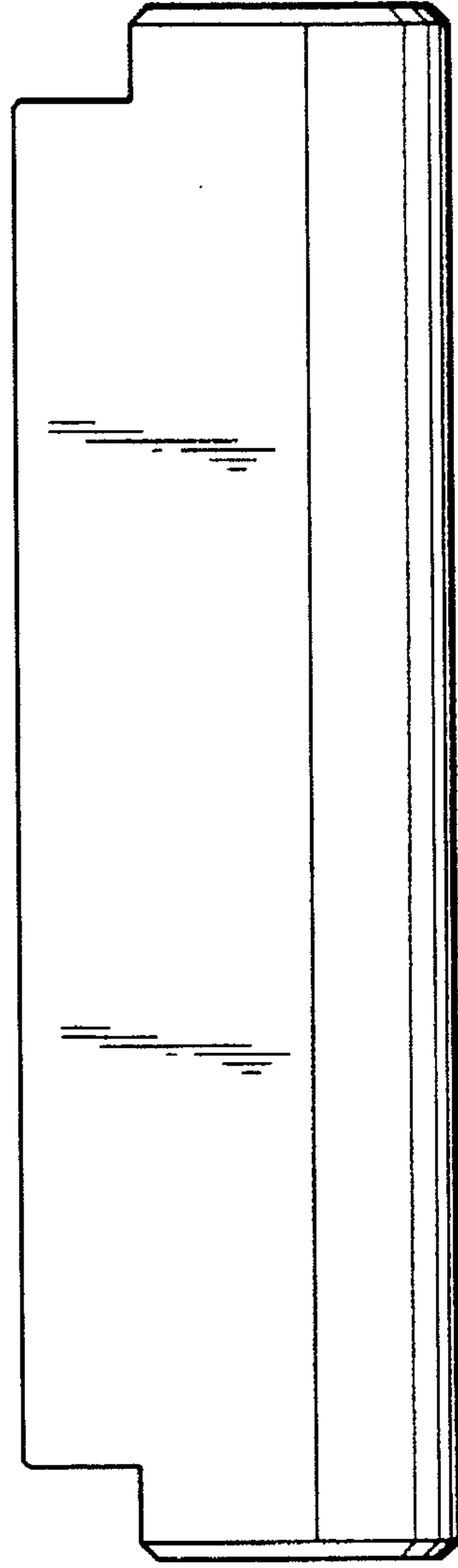

FIG. 6

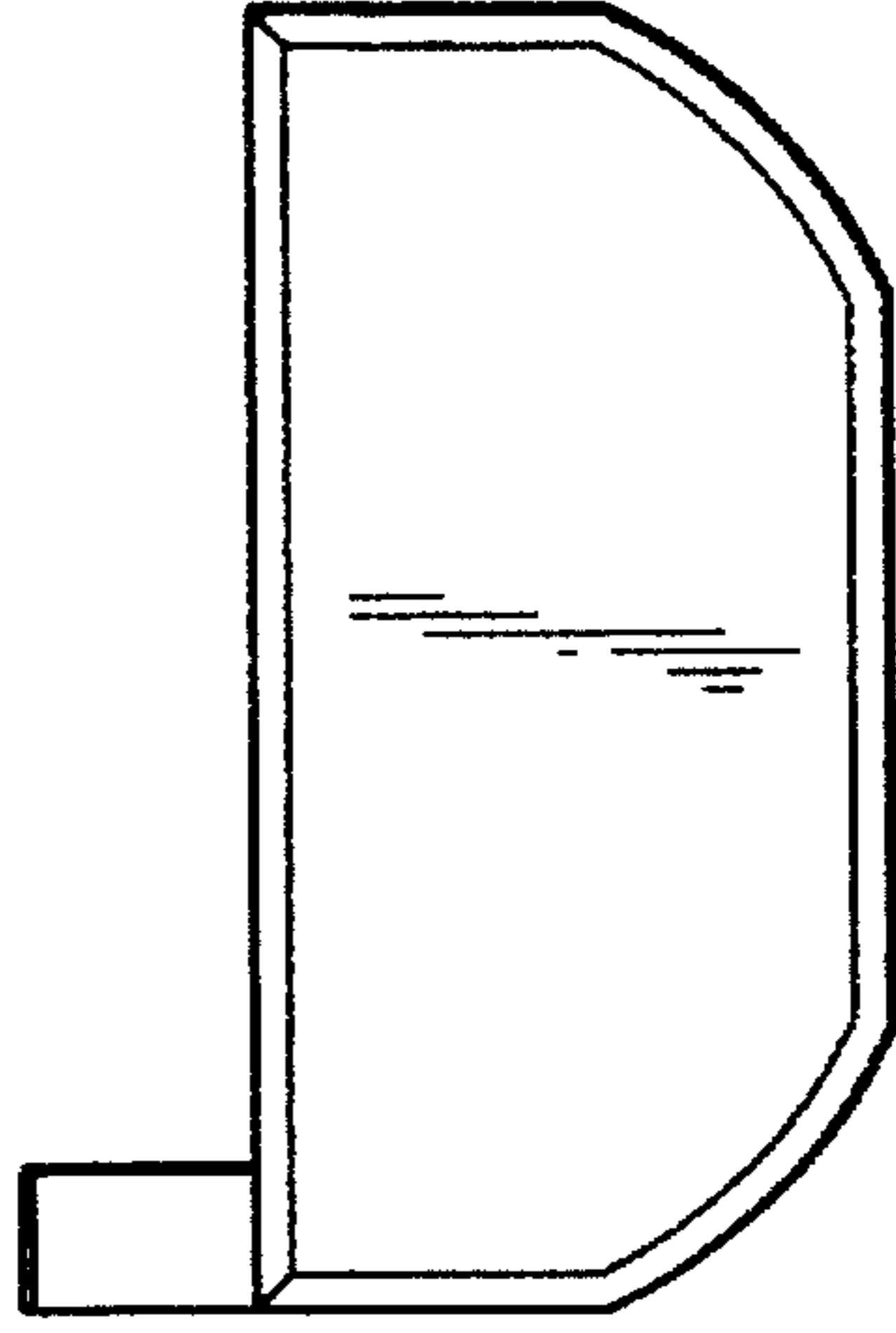

FIG. 7