



US00D381124S

# United States Patent [19] Blachut

[11] Patent Number: **Des. 381,124**  
[45] Date of Patent: **\*\*Jul. 15, 1997**

## [54] COSMETIC COMPACT

[75] Inventor: **Longin Blachut**, Lugano, Switzerland

[73] Assignee: **Techpack-Laffon GmbH**, Munich, Germany

[\*\*] Term: **14 Years**

[21] Appl. No.: **14,722**

[22] Filed: **Oct. 29, 1993**

### [30] Foreign Application Priority Data

Apr. 29, 1993 [IT] Italy ..... MI930 000258

[51] LOC (6) Cl. .... **28-03**

[52] U.S. Cl. .... **D28/78**

[58] Field of Search ..... D28/76-84; D9/420-424;  
132/293-296, 298, 299, 301-307, 316;  
206/235, 581, 823; 220/DIG. 26

### [56] References Cited

#### U.S. PATENT DOCUMENTS

D. 140,877	4/1945	Le Sage	.....	220/DIG. 26
D. 280,450	9/1985	Schefer	.....	D28/78
D. 302,602	8/1989	Bakic	.....	D28/78
D. 318,346	7/1991	Bakic	.....	D28/82
D. 339,882	9/1993	Chevassus	.....	D28/82
D. 342,808	12/1993	Bakic	.....	D28/82
1,950,465	3/1934	Whitlock	.....	220/DIG. 26
4,276,893	7/1981	Enomoto et al.	.....	132/301
4,589,431	5/1986	Yuhara	.....	132/301
5,107,871	4/1992	Butcher et al.	.....	D28/83 X
5,323,794	6/1994	Favre	.....	132/294

#### FOREIGN PATENT DOCUMENTS

2647319	11/1990	France	.....	401/88
3821390	12/1989	Germany	.....	132/293
2168326	6/1986	United Kingdom	.....	206/823

## OTHER PUBLICATIONS

"Beauty Fashion"; Jul. 1986; p. 20: Open Compacts.

"D. & C.I."; Apr. 1986; p. 66 —Oval Compacts on center right.

*Primary Examiner*—Ted Shooman

*Assistant Examiner*—C. Tuttle

*Attorney, Agent, or Firm*—Cushman Darby & Cushman IP Group of Pillsbury Madison & Sutro LLP

## [57] CLAIM

The ornamental design for a cosmetic compact, as shown and described.

## DESCRIPTION

FIG. 1 is a front elevational view of a cosmetic compact in a closed condition, showing my new design;

FIG. 2 is a top plan view thereof;

FIG. 3 is a left side elevational view thereof;

FIG. 4 is a rear elevational view thereof;

FIG. 5 is a bottom plan view thereof;

FIG. 6 is a right side elevational view thereof;

FIG. 7 is a perspective view thereof from the front, top and right side;

FIG. 8 is a perspective view thereof from the front, top and right side thereof, with the lid thereof raised to an open condition;

FIG. 9 is a top plan view thereof in the condition shown in FIG. 8; and,

FIG. 10 is a front elevational view thereof in the condition shown in FIG. 8.

**1 Claim, 4 Drawing Sheets**

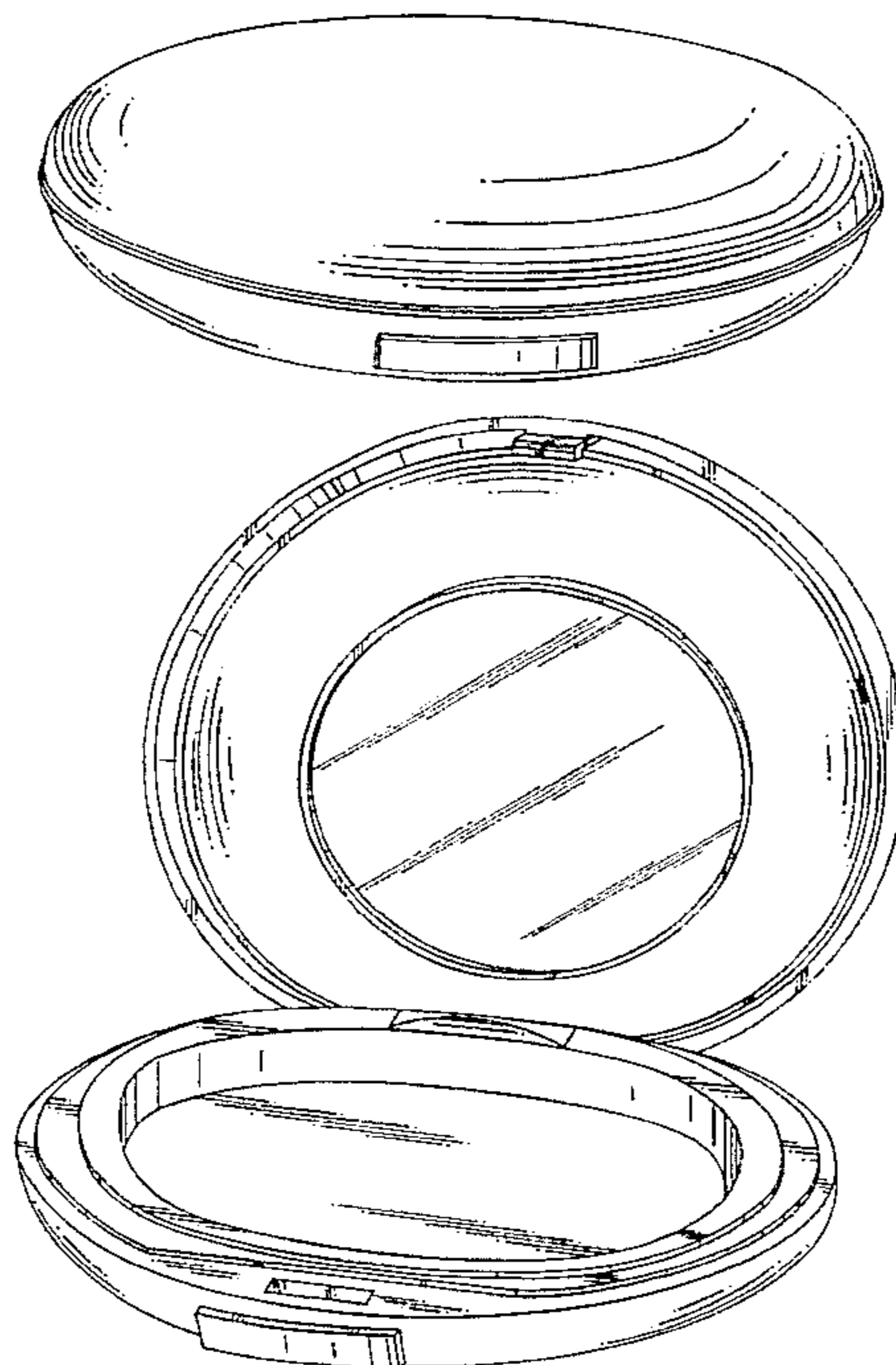

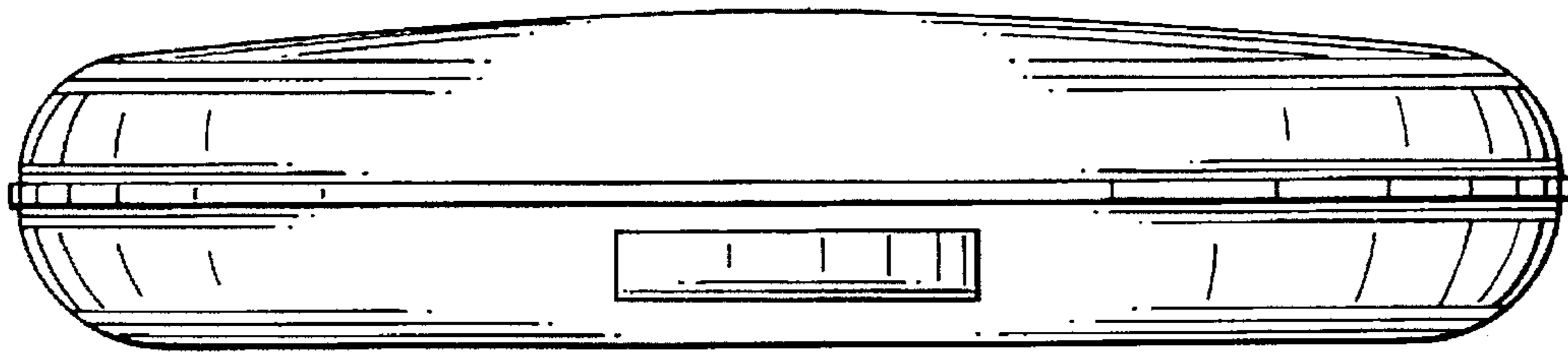

FIG. 1

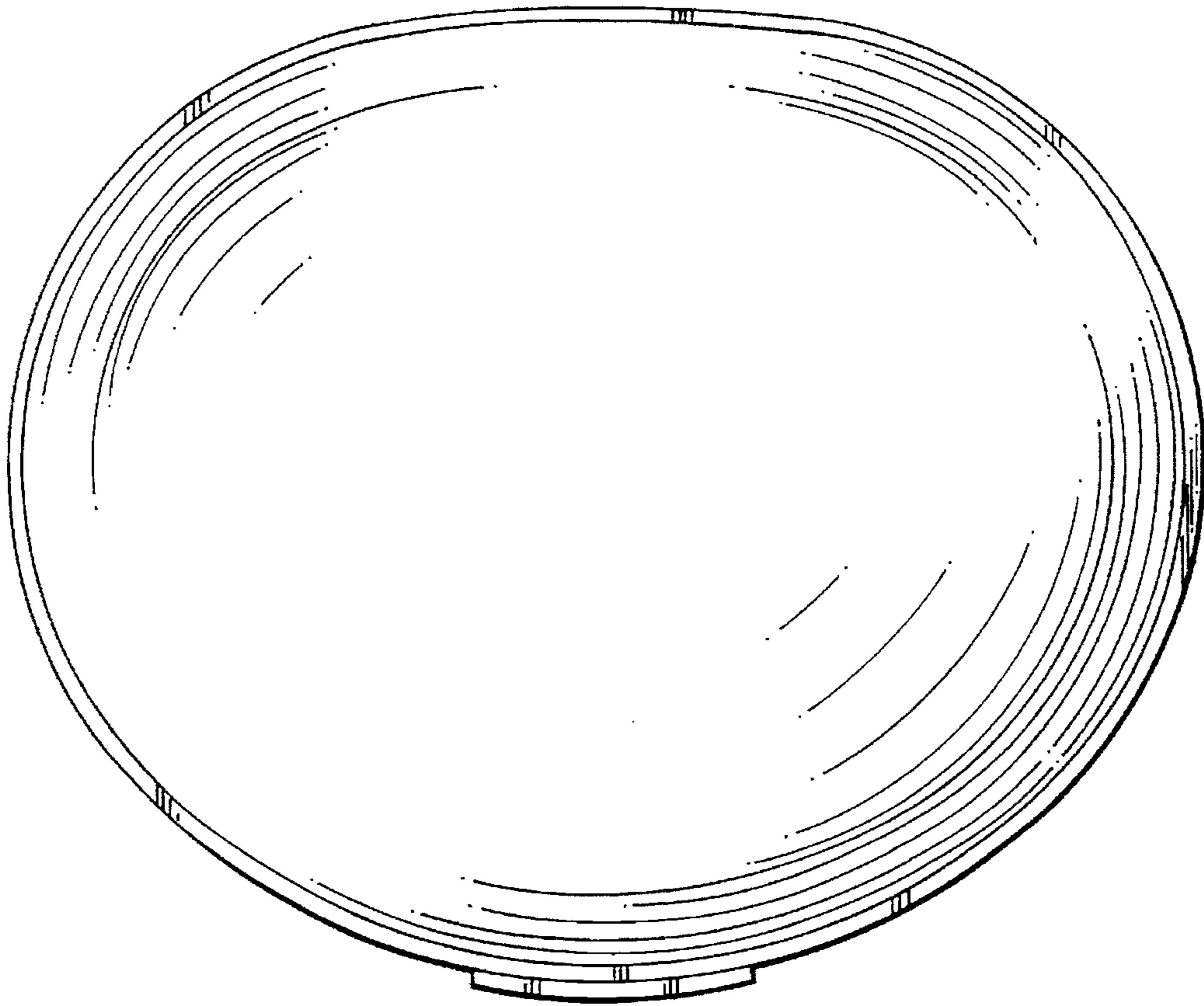

FIG. 2

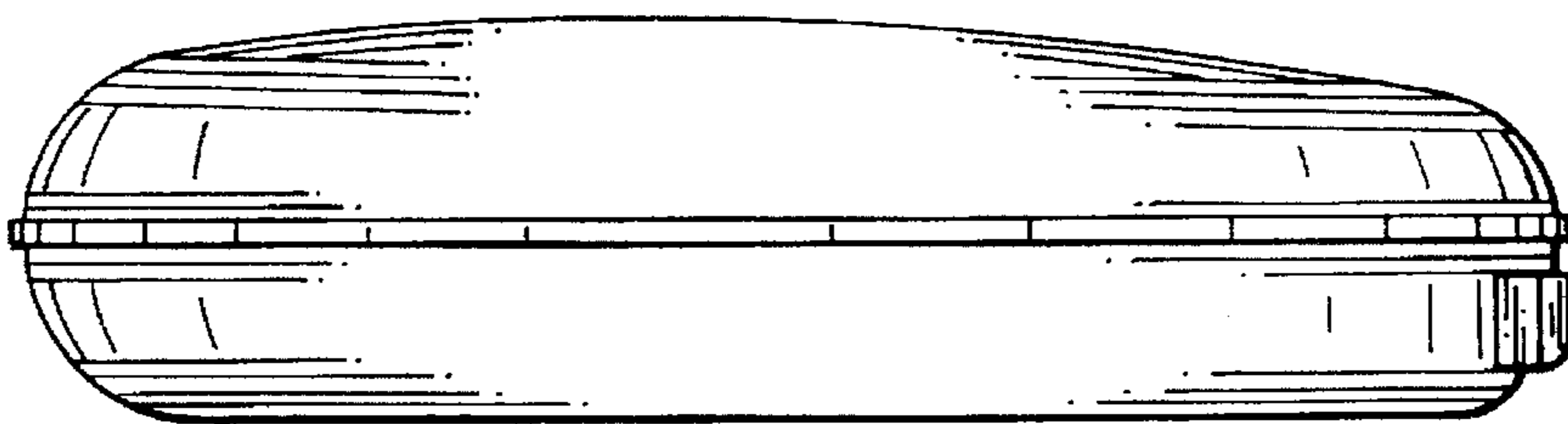

FIG. 3

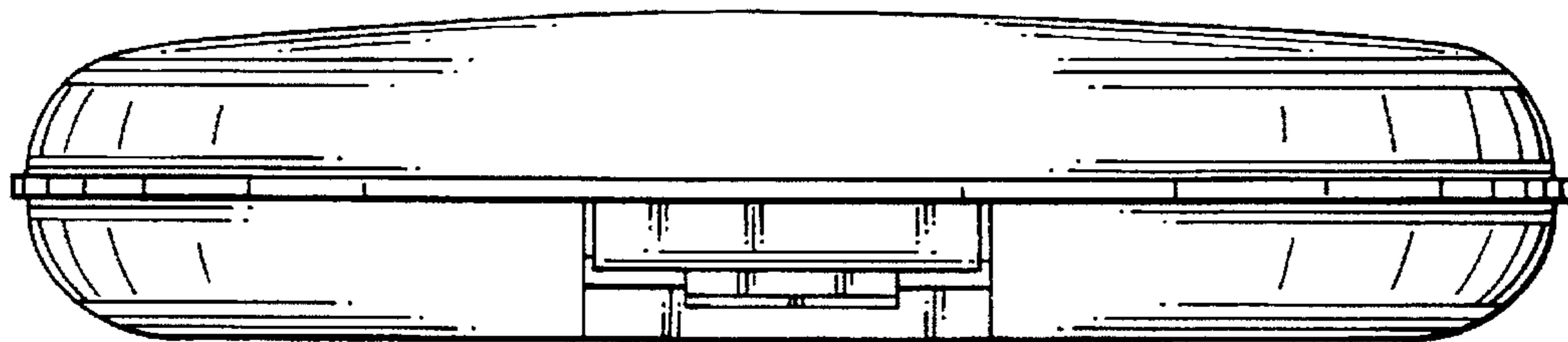

FIG. 4

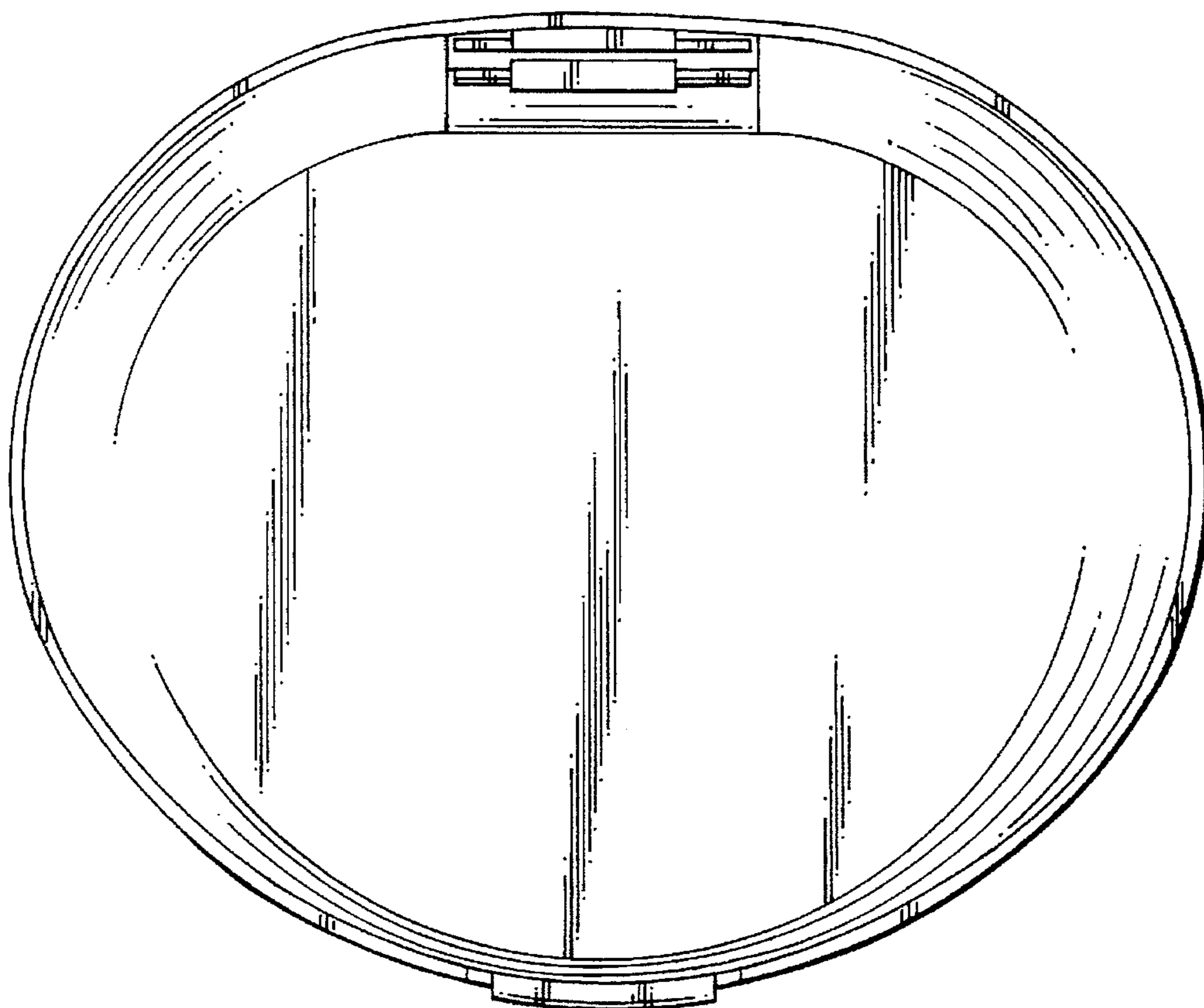

FIG. 5

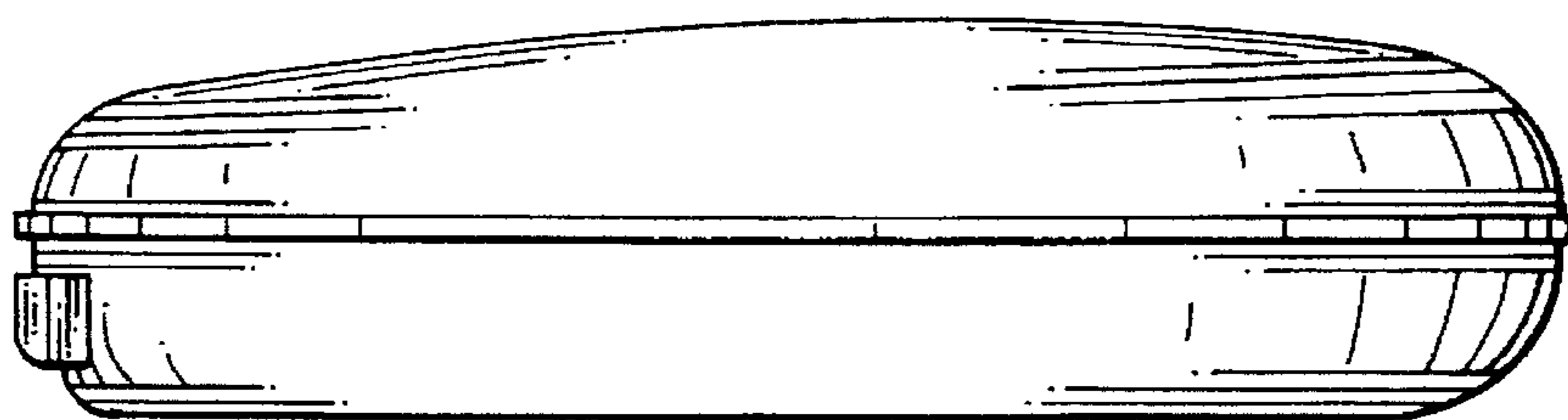

FIG. 6

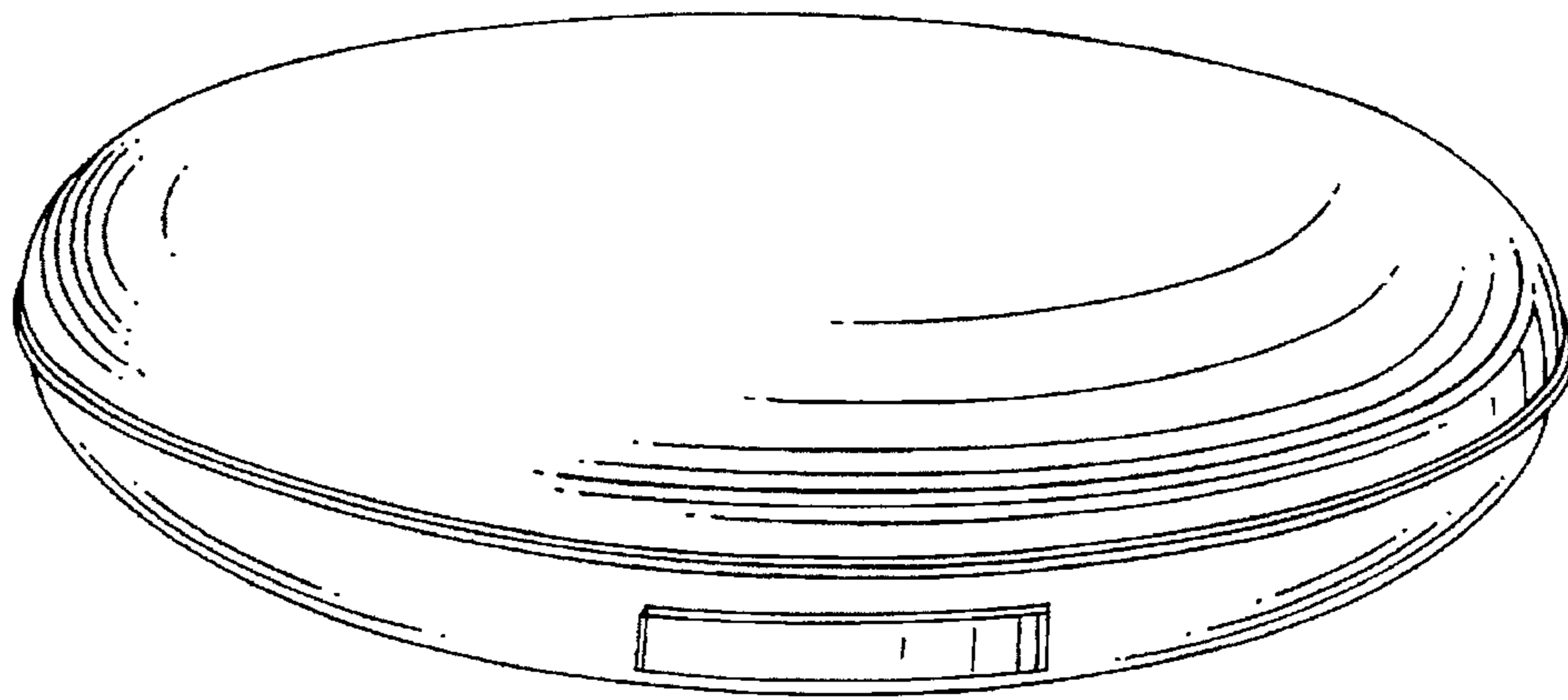

FIG. 7

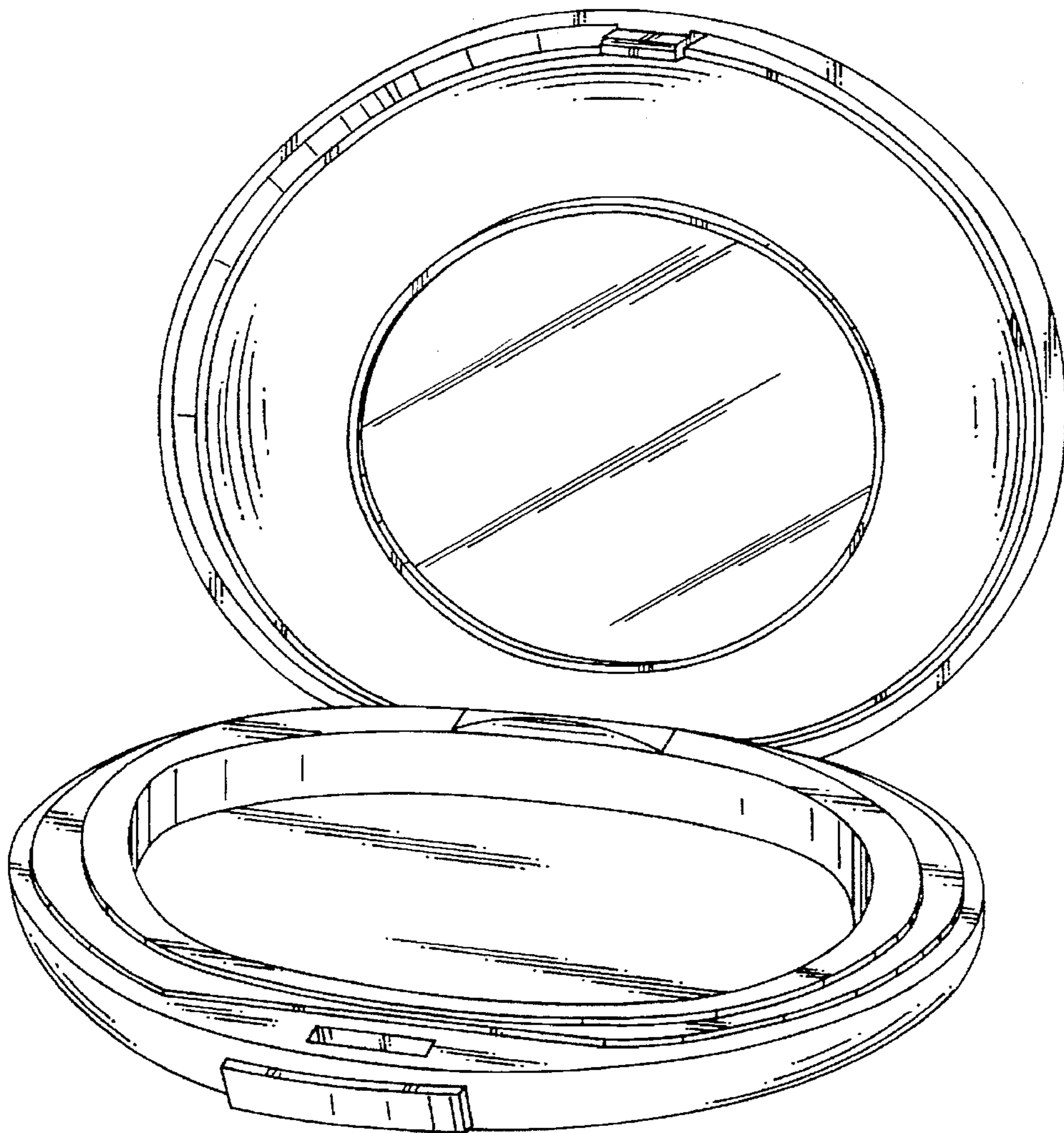

FIG. 8

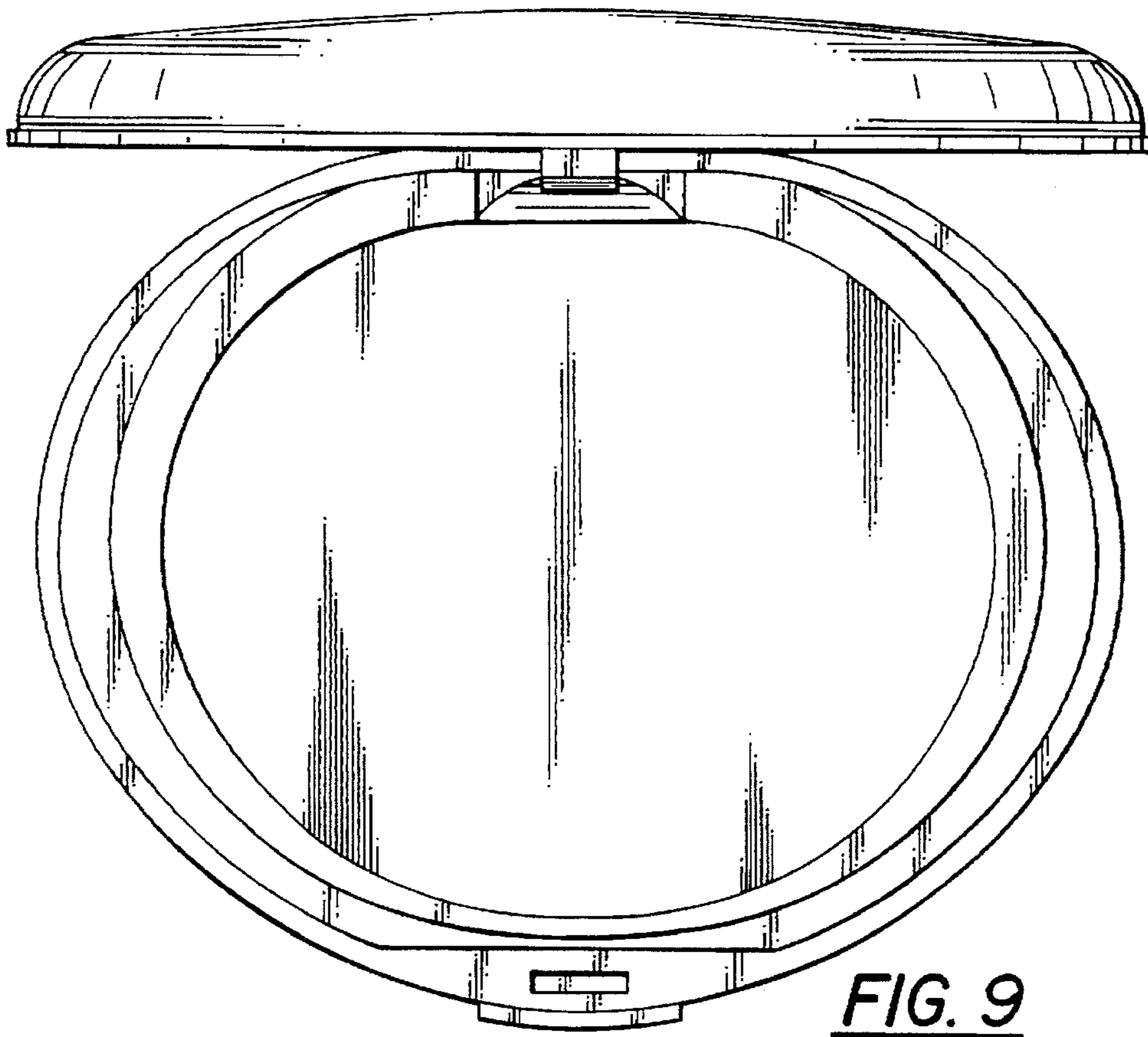

FIG. 9

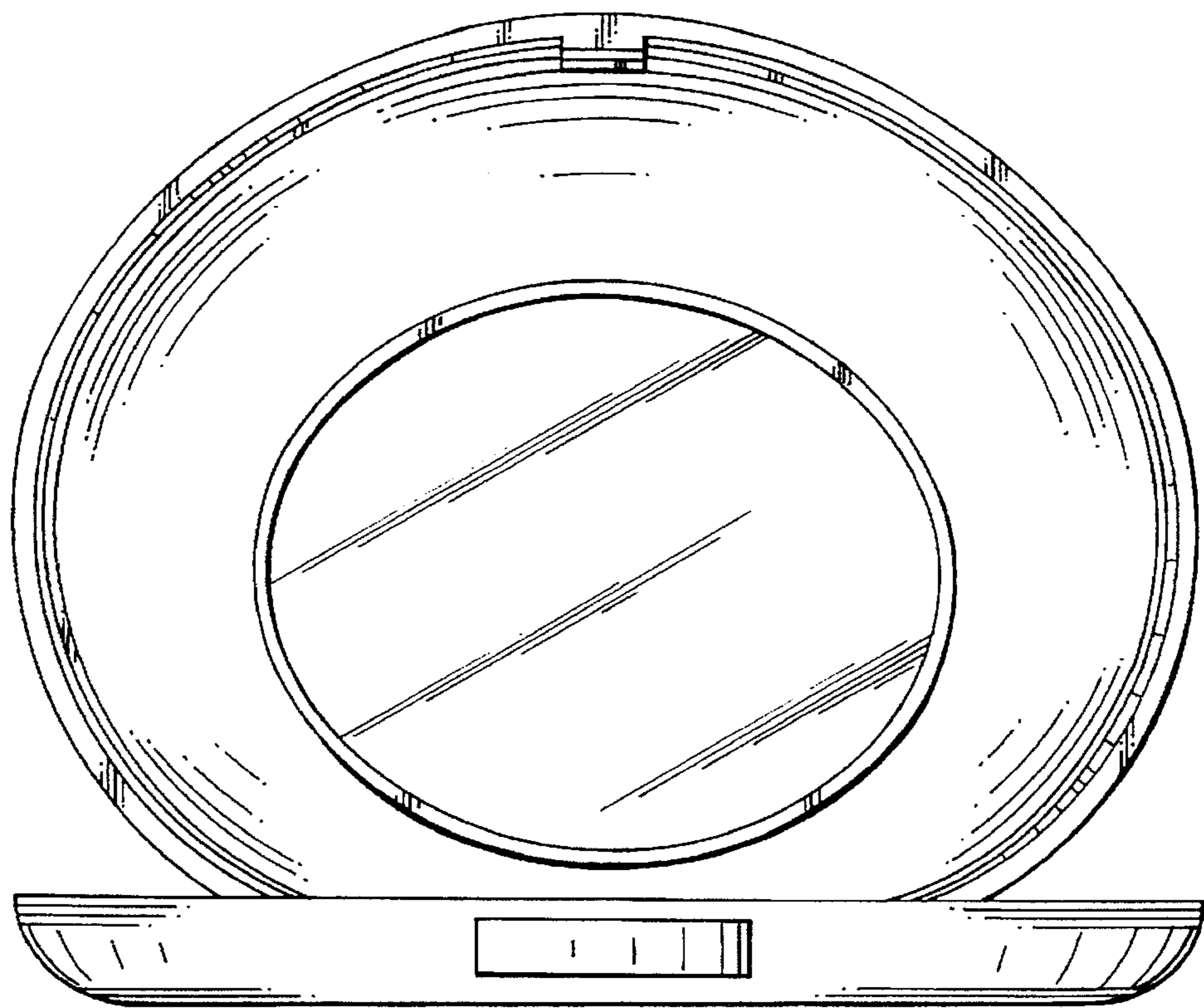

FIG. 10