



US00D381119S

United States Patent [19] Chang

[11] Patent Number: **Des. 381,119**

[45] Date of Patent: ****Jul. 15, 1997**

[54] **HAIR CLIP**

[76] Inventor: **Wen-Hsiung Chang**, No. 32, Lane 232,
Chung Shan Road, Tainan, Taiwan

[**] Term: **14 Years**

[21] Appl. No.: **47,156**

[22] Filed: **Nov. 28, 1995**

[51] LOC (6) Cl. **28-03**

[52] U.S. Cl. **D28/40; D28/29; D28/25**

[58] Field of Search **D28/25-33, 35,
D28/38, 21; 132/126-139, 144, 148-150,
158-160, 273, 275, 277**

[56] **References Cited**

U.S. PATENT DOCUMENTS

D. 163,687	6/1951	Friedman	D28/27	X
785,429	3/1905	Metcalf	132/146	
2,279,997	4/1942	Kantor	132/223	
2,712,319	7/1955	Roitner	132/129	
5,494,060	2/1996	Potut	132/279	X

FOREIGN PATENT DOCUMENTS

609324	8/1926	France	132/144
321799	11/1929	United Kingdom	132/135

OTHER PUBLICATIONS

Hong Kong Enterprise Jun. 1995; p. 91: item Nos. B448/
VG, B447M and B446N, to the left side of center in rows 6,
7 and 8 Jun. 1995.

Primary Examiner—Ted Shooman

Assistant Examiner—C. Tuttle

Attorney, Agent, or Firm—Morton J. Rosenberg; David I.
Klein

[57] **CLAIM**

The ornamental design for a hair clip, as shown and
described.

DESCRIPTION

FIG. 1 is a perspective view of a hair clip showing my new
design;

FIG. 2 is a front elevational view thereof;

FIG. 3 is a rear elevational view thereof;

FIG. 4 is a left side elevational view thereof;

FIG. 5 is a right side elevational view thereof;

FIG. 6 is a top plan view thereof; and,

FIG. 7 is a bottom plan view thereof.

1 Claim, 3 Drawing Sheets

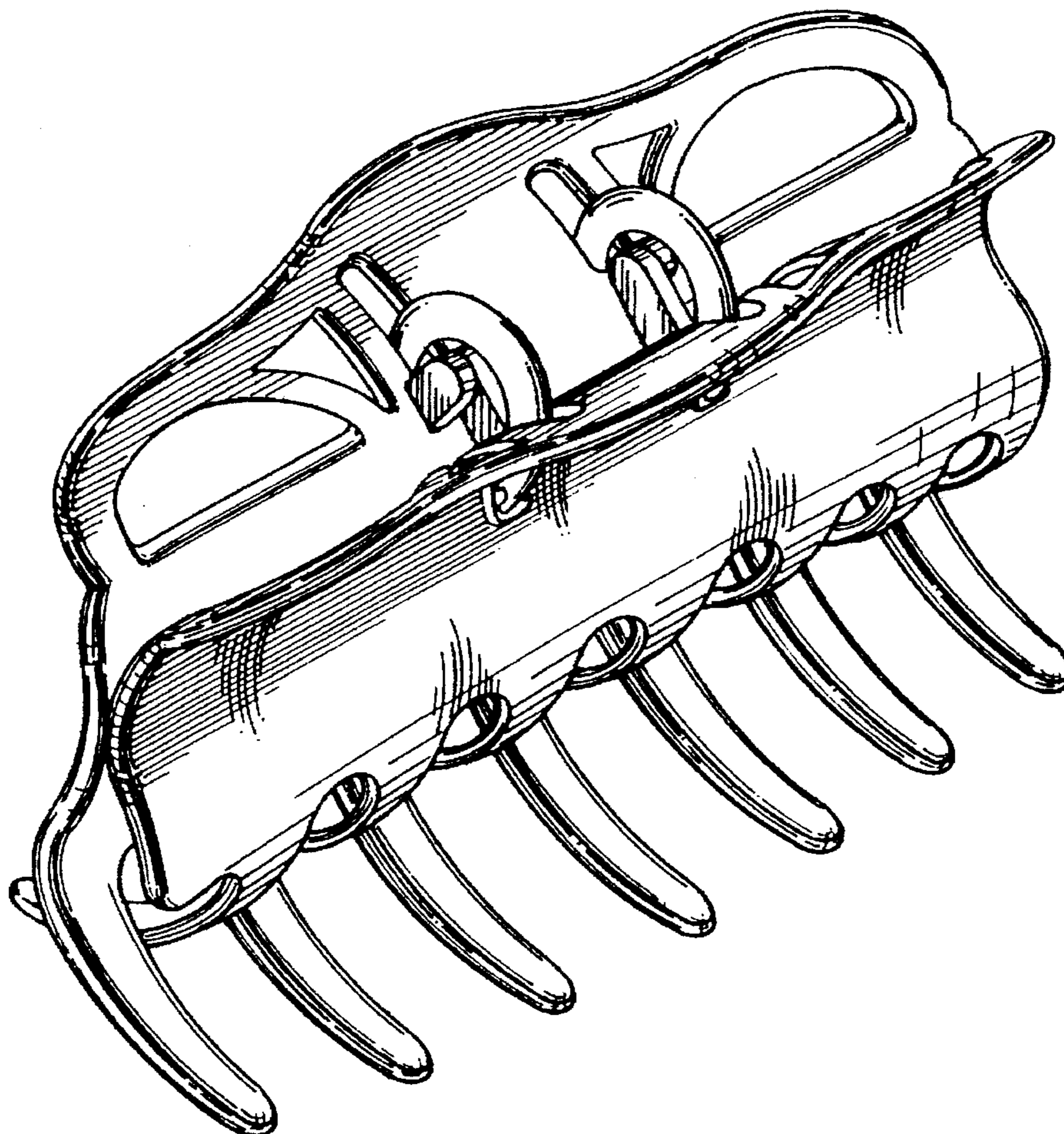

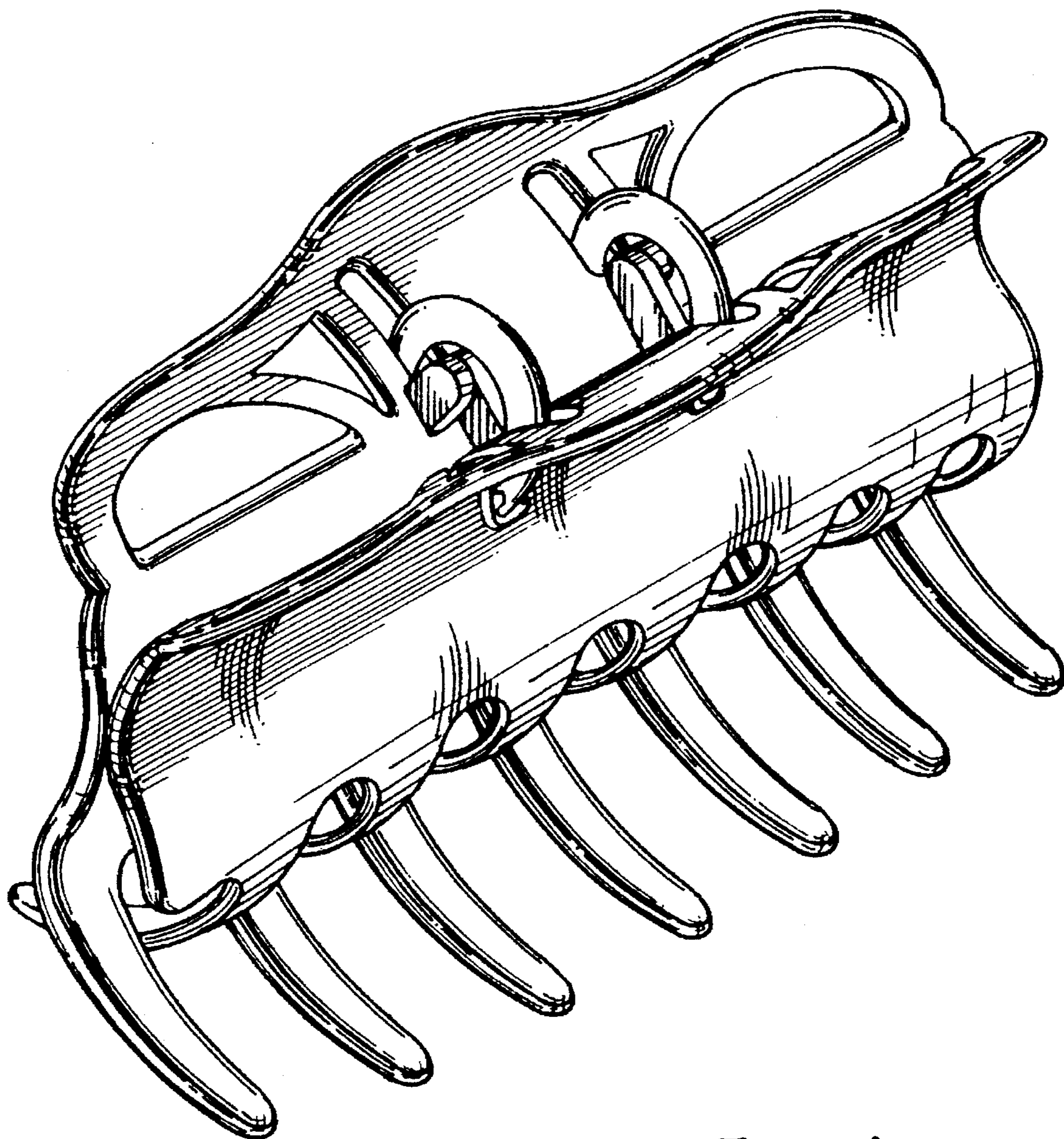

Fig. 1

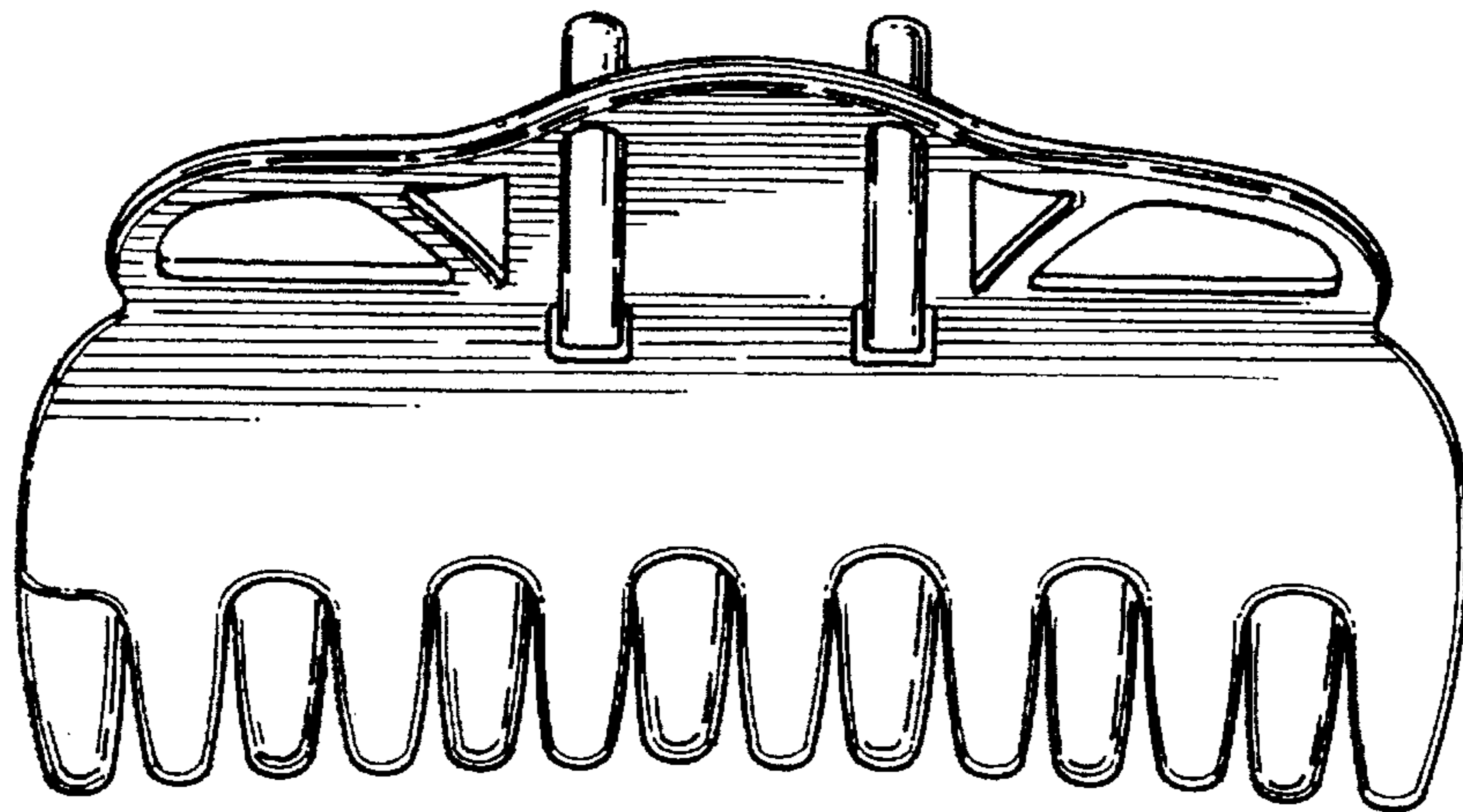

Fig. 2

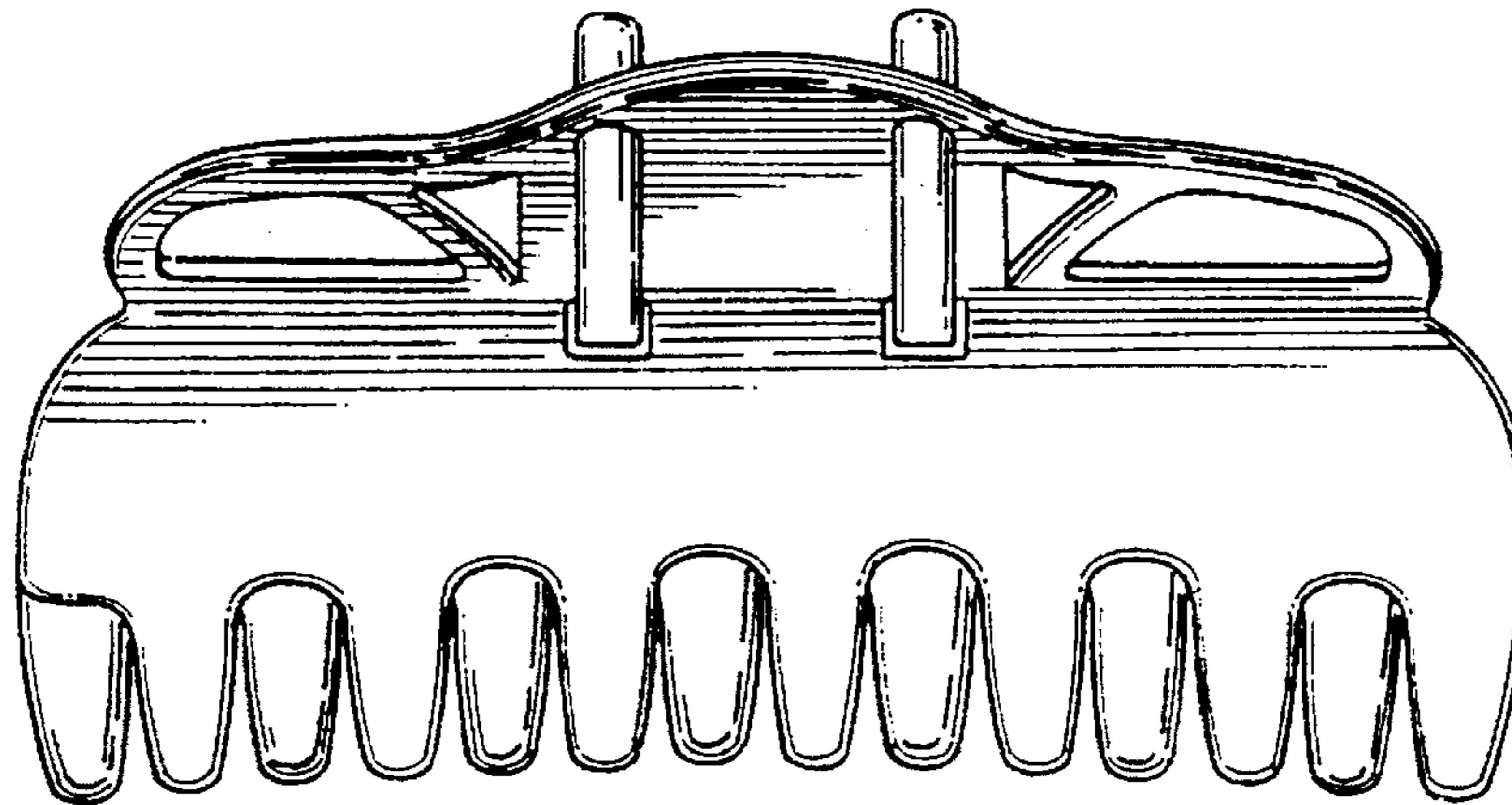

Fig. 3

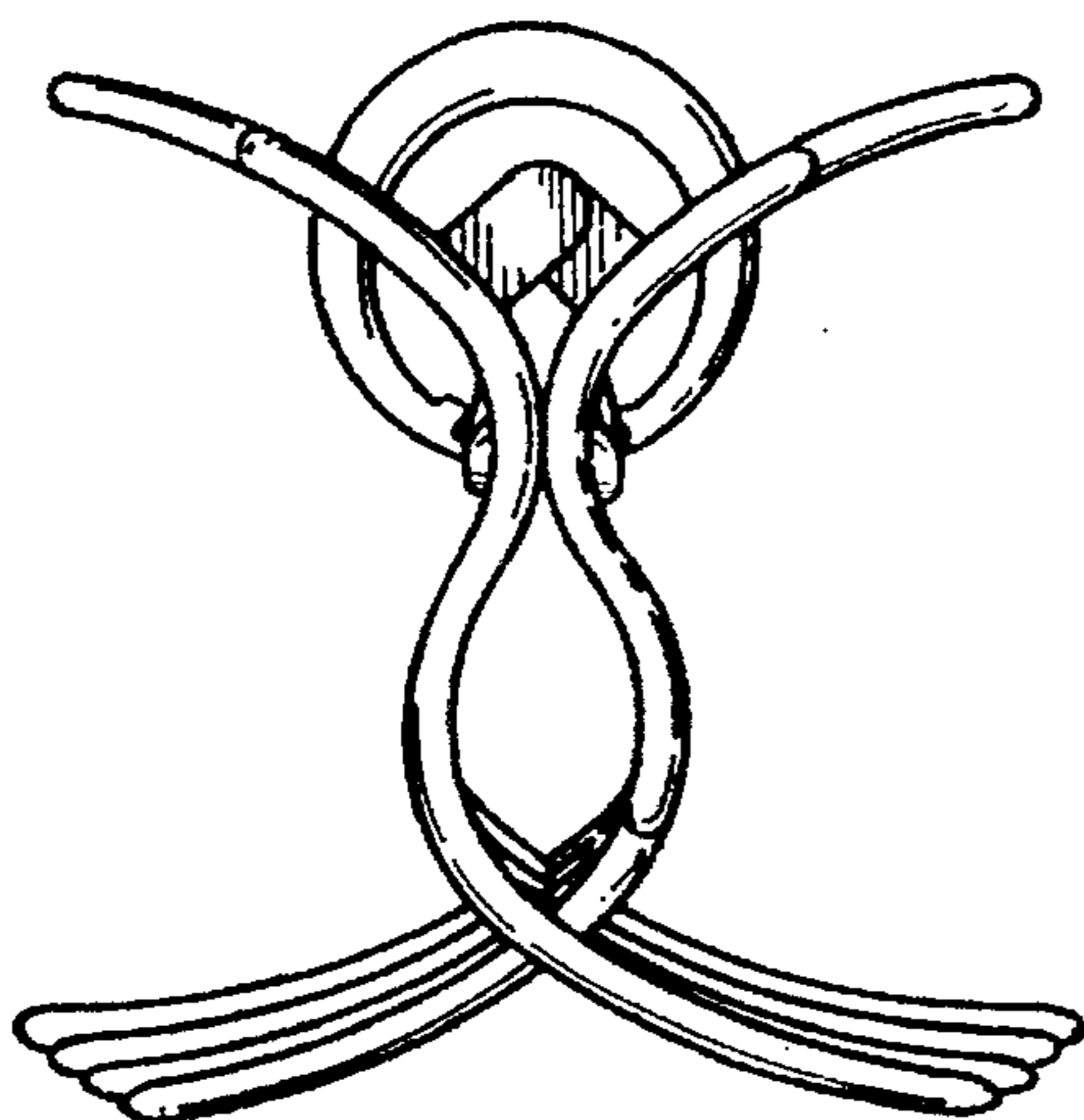

Fig. 4

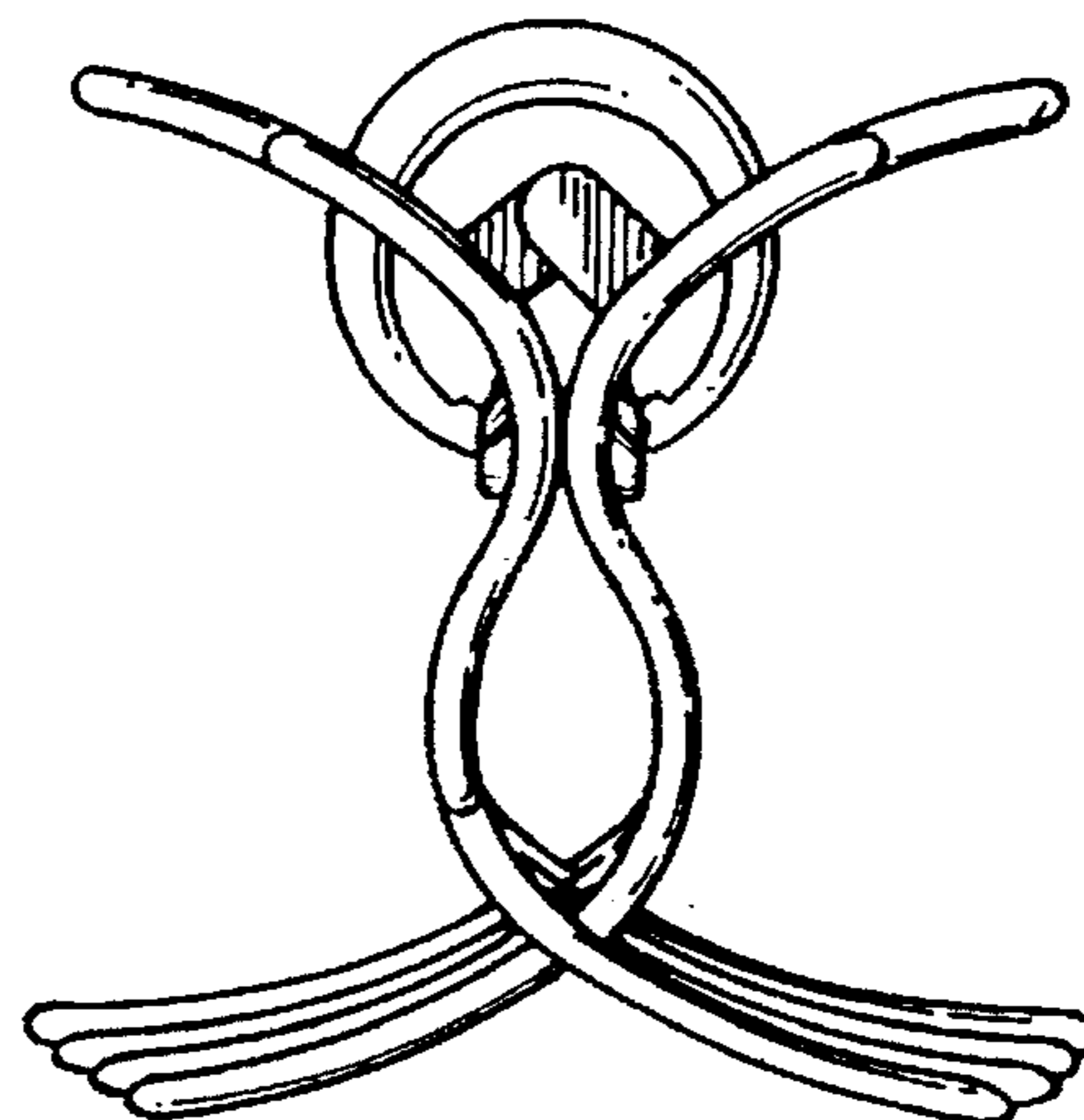

Fig. 5

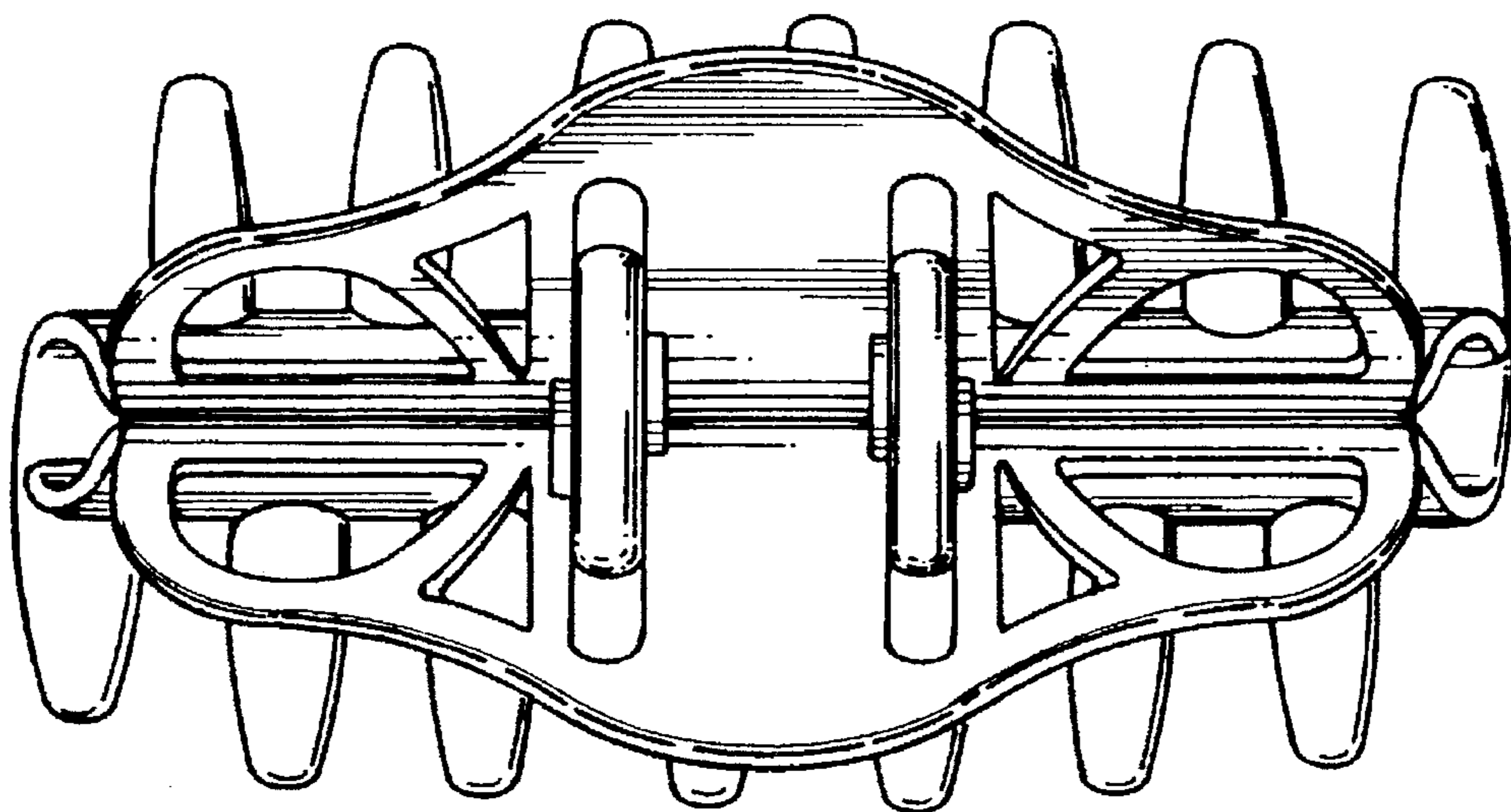

Fig. 6

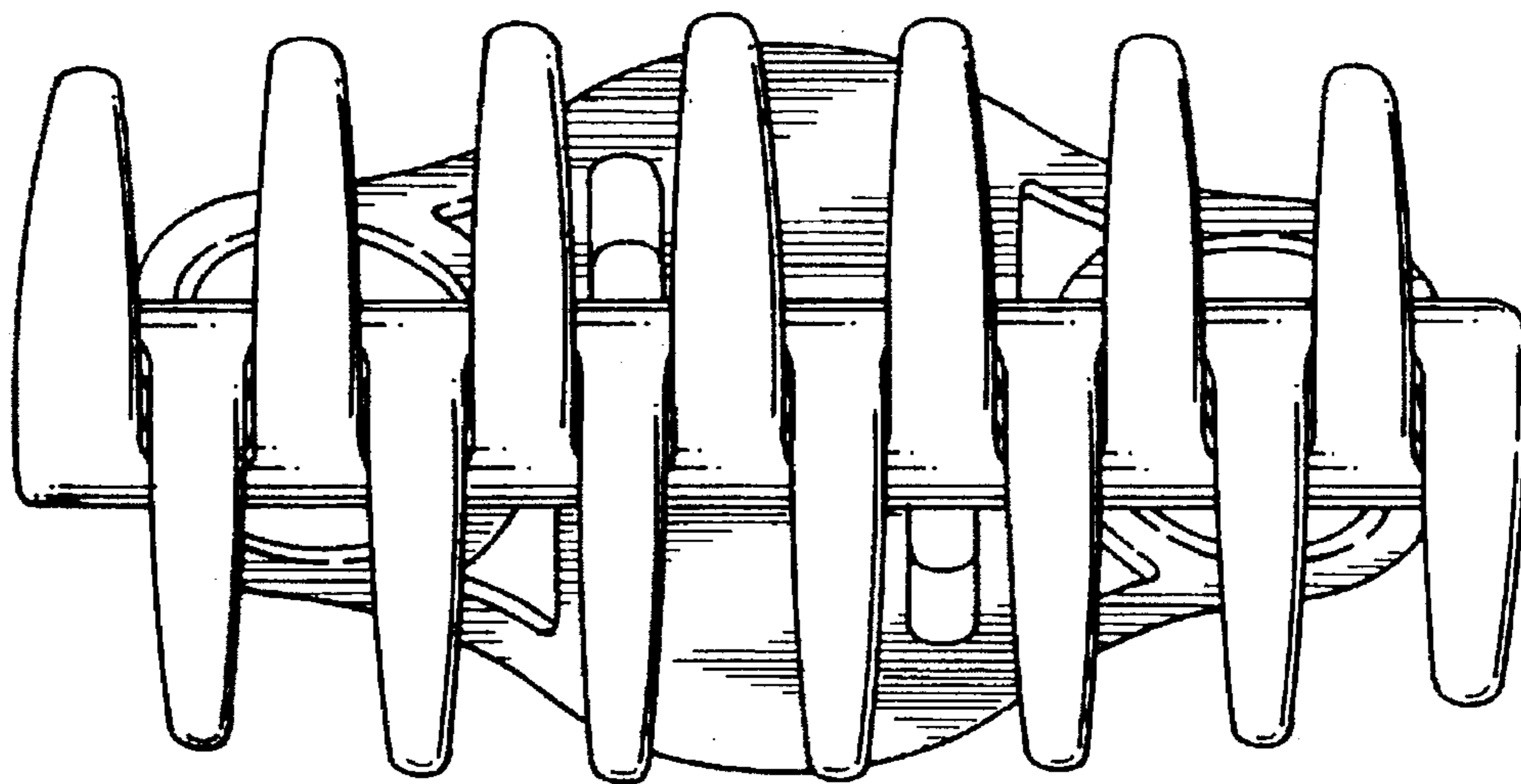

Fig. 7