



US00D381059S

United States Patent [19]
Simpson et al.

[11] **Patent Number: Des. 381,059**
[45] **Date of Patent: **Jul. 15, 1997**

[54] **VIDEO CAMERA MOUNTING DEVICE**

[76] Inventors: **Craig B. Simpson; Craig Adamson,**
both of 748 N. 300 West, Mapleton,
Utah 84664

[**] Term: **14 Years**

[21] Appl. No.: **54,231**

[22] Filed: **May 10, 1996**

[51] **LOC (6) Cl. 22-01**

[52] **U.S. Cl. D22/110; D22/109**

[58] **Field of Search D22/100, 101,**
D22/107, 108, 109, 110, 199; 33/233, 241,
242, 244, 261; 42/94, 101; 248/187.1

[56] **References Cited**

U.S. PATENT DOCUMENTS

D. 308,089	5/1990	Sanders	D22/109
2,840,334	6/1958	Cauthen	248/187.1
4,943,820	7/1990	Larock	248/187.1 X
4,962,589	10/1990	LaRosa	33/233
5,081,478	1/1992	Hayashida et al.	248/187.1 X

FOREIGN PATENT DOCUMENTS

79146	3/1919	Germany	33/242
-------	--------	---------	-------	--------

OTHER PUBLICATIONS

"Film at Eleven", Holt Boldinson, *Guns*, Dec. 1995, pp. 64, 65.

Primary Examiner—Louis S. Zarfaz
Assistant Examiner—Monica A. Weingart
Attorney, Agent, or Firm—Madson & Metcalf

[57] **CLAIM**

The ornamental design for a video camera mounting device, as shown and described.

DESCRIPTION

FIG. 1 is a perspective view of the video camera mounting device of the present invention illustrating the manner in which it is used to mount a video camera to a hunting rifle; FIG. 2 is a perspective view of the video camera mounting device; FIG. 3 is a front view of the video camera mounting device; FIG. 4 is a side view of the video camera mounting device; FIG. 5 is a top plan view of the video camera mounting device; FIG. 6 is a bottom view of the video camera mounting device; and, FIG. 7 is a side view of the video camera mounting device. The broken line showing of a video camera and rifle is for illustrative purposes only and forms no part of the claimed design.

1 Claim, 4 Drawing Sheets

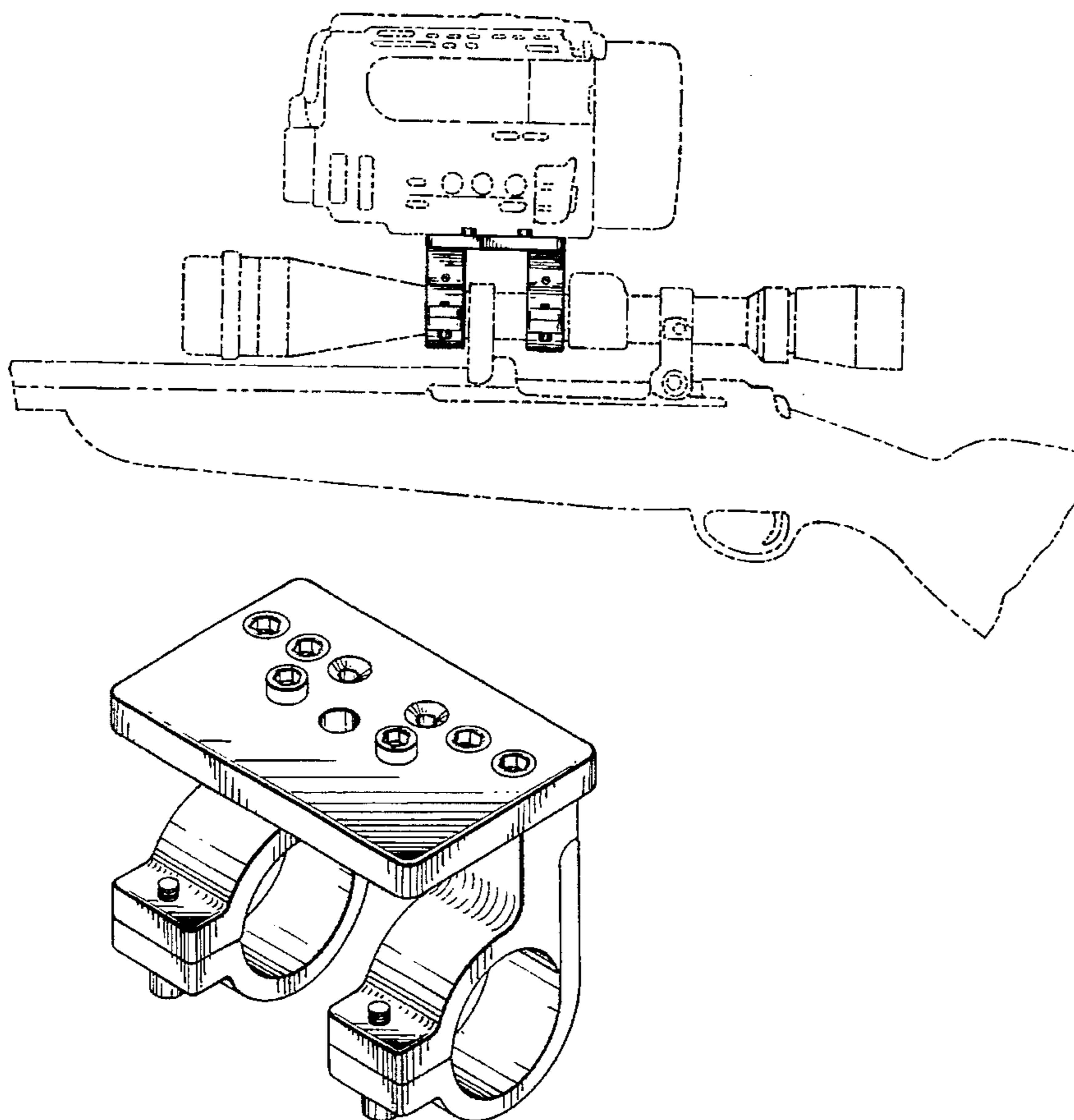

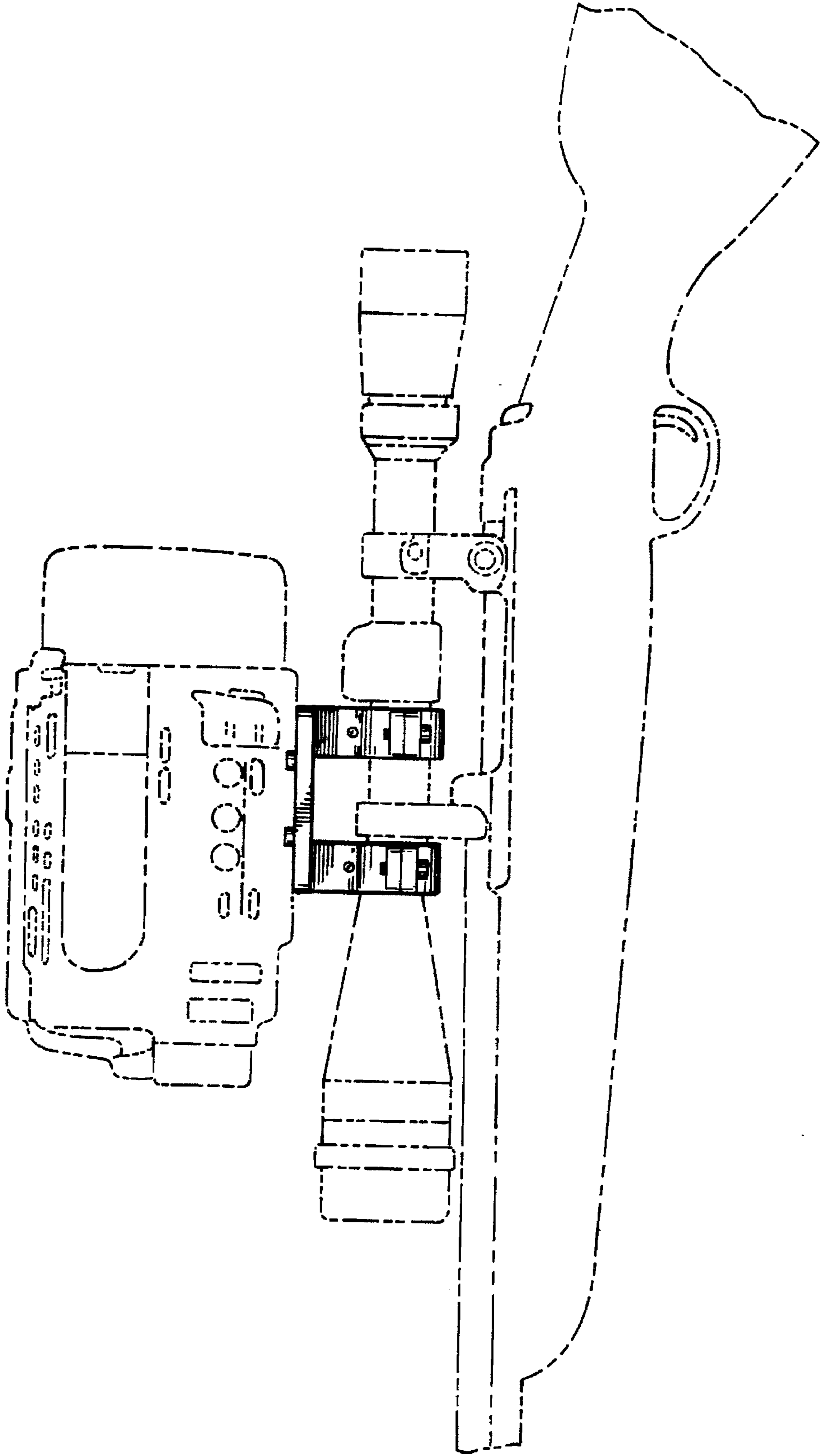

FIG. 1

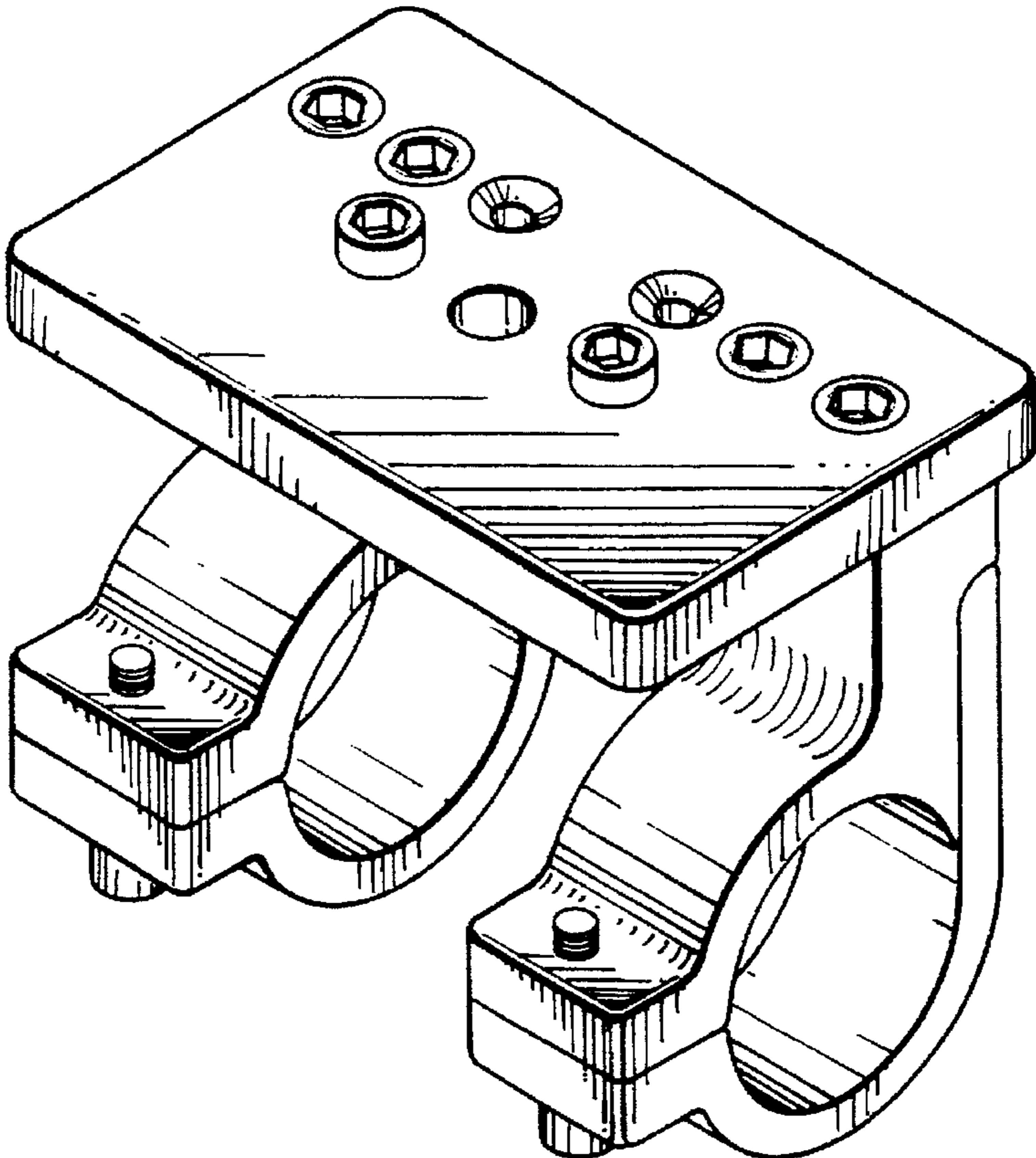

FIG. 2

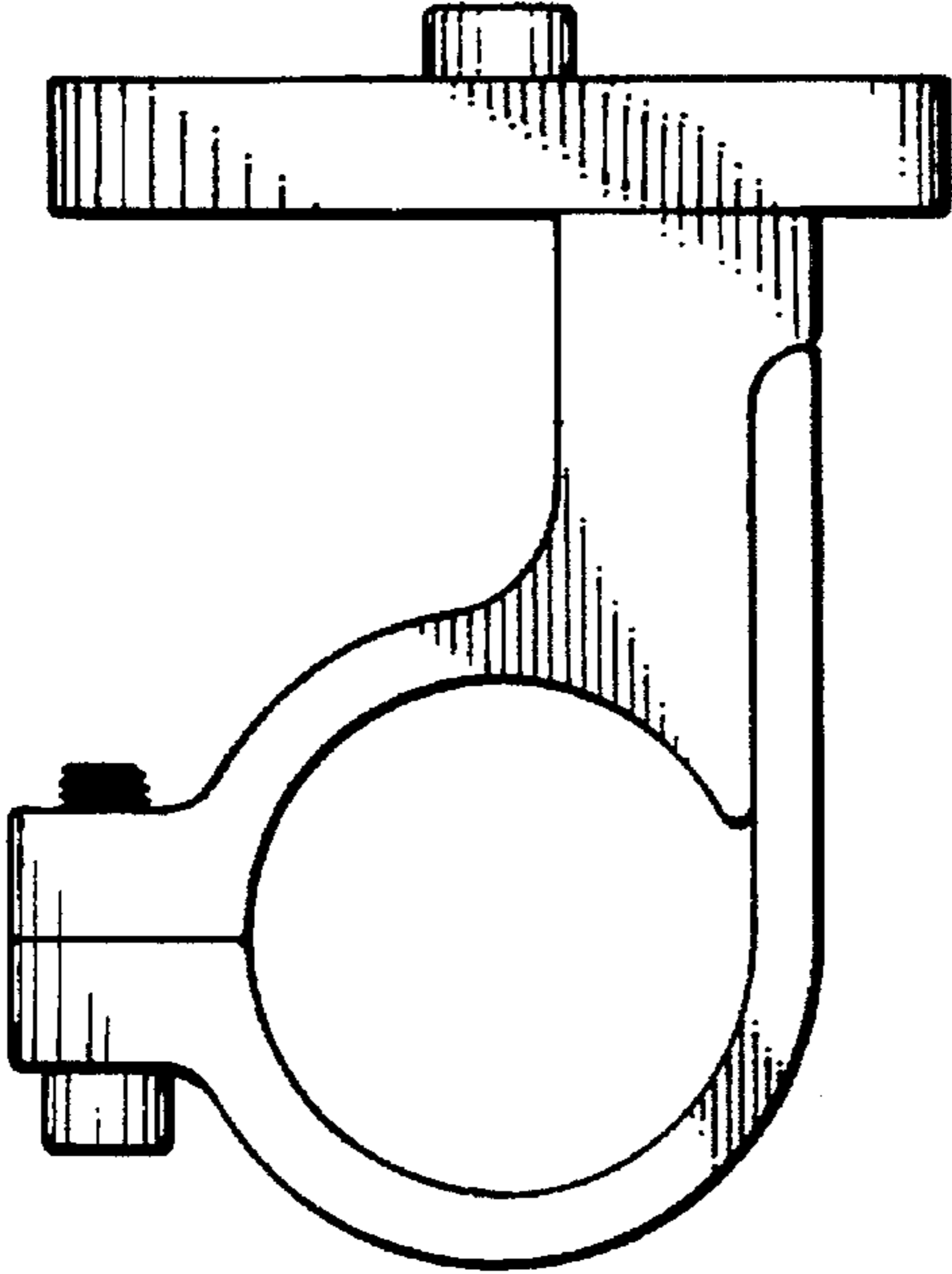

FIG. 3

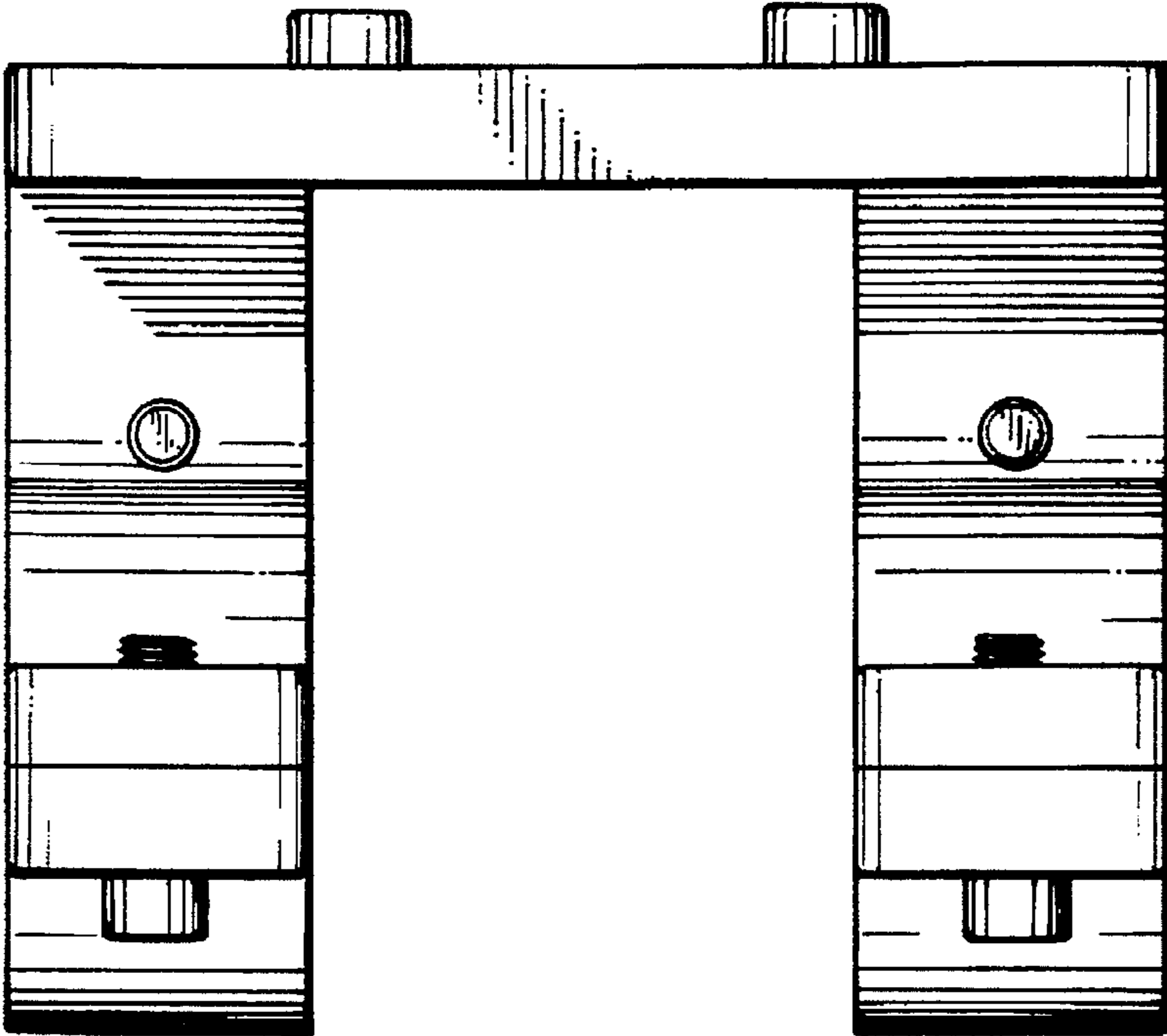

FIG. 4

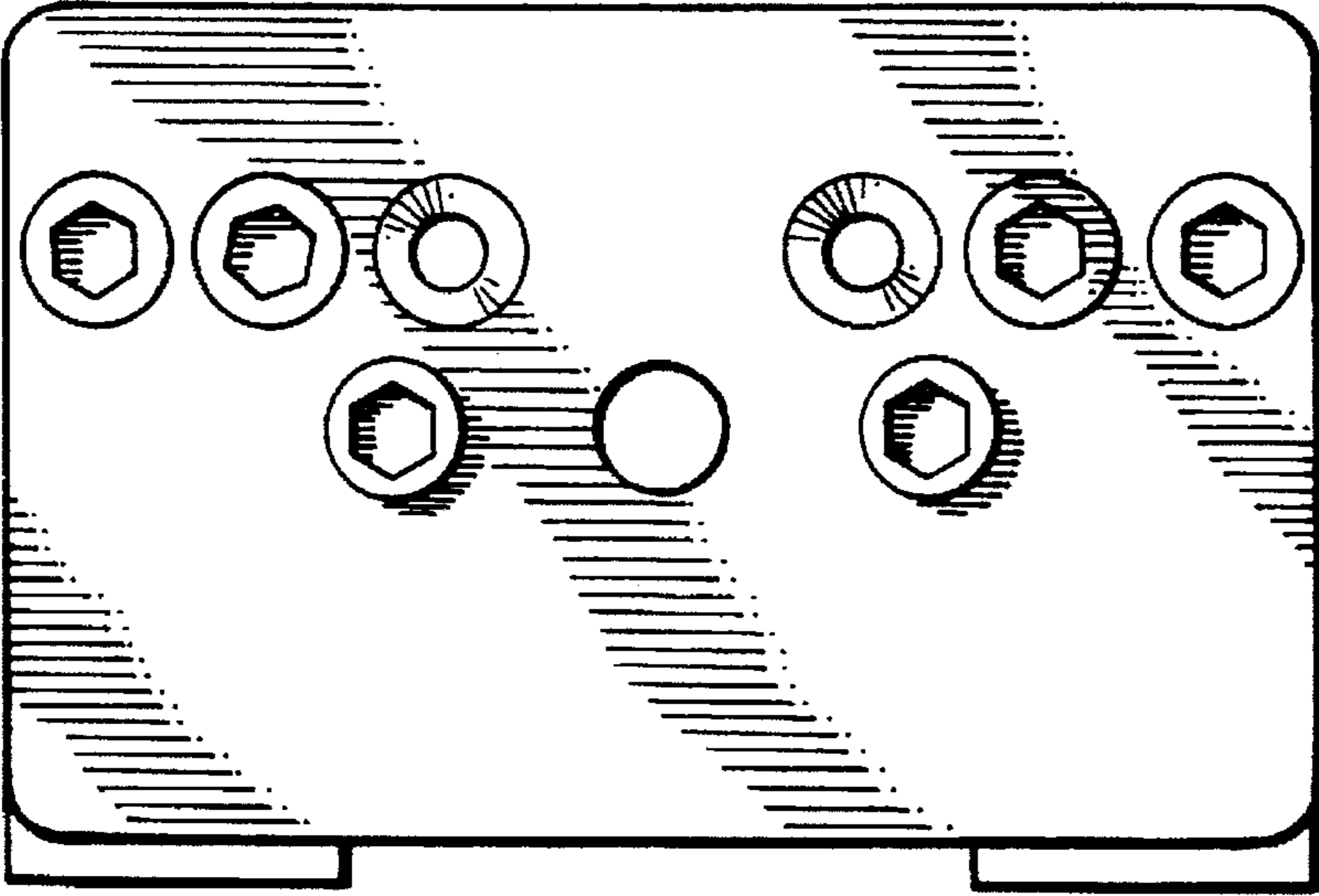

FIG. 5

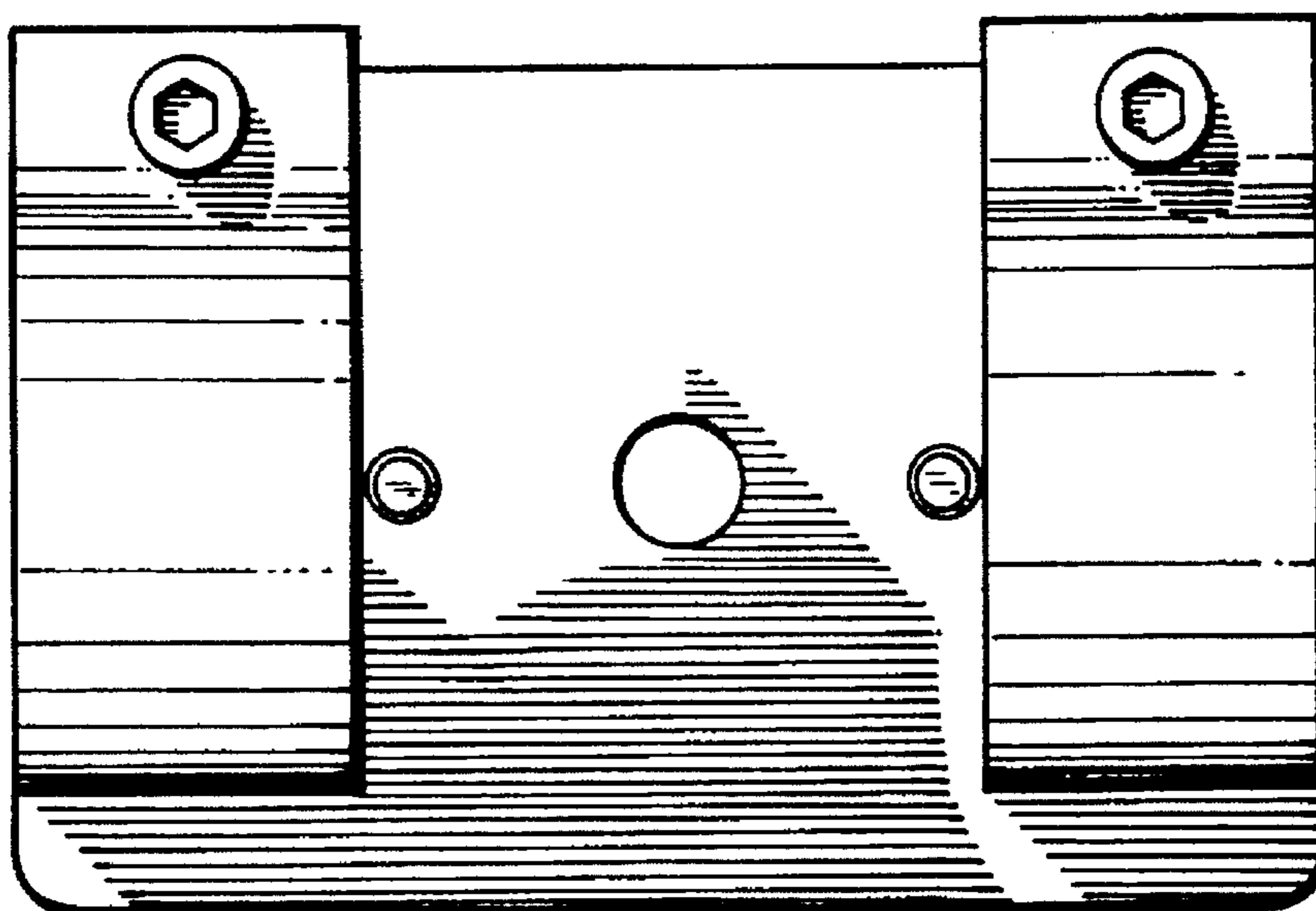

FIG. 6

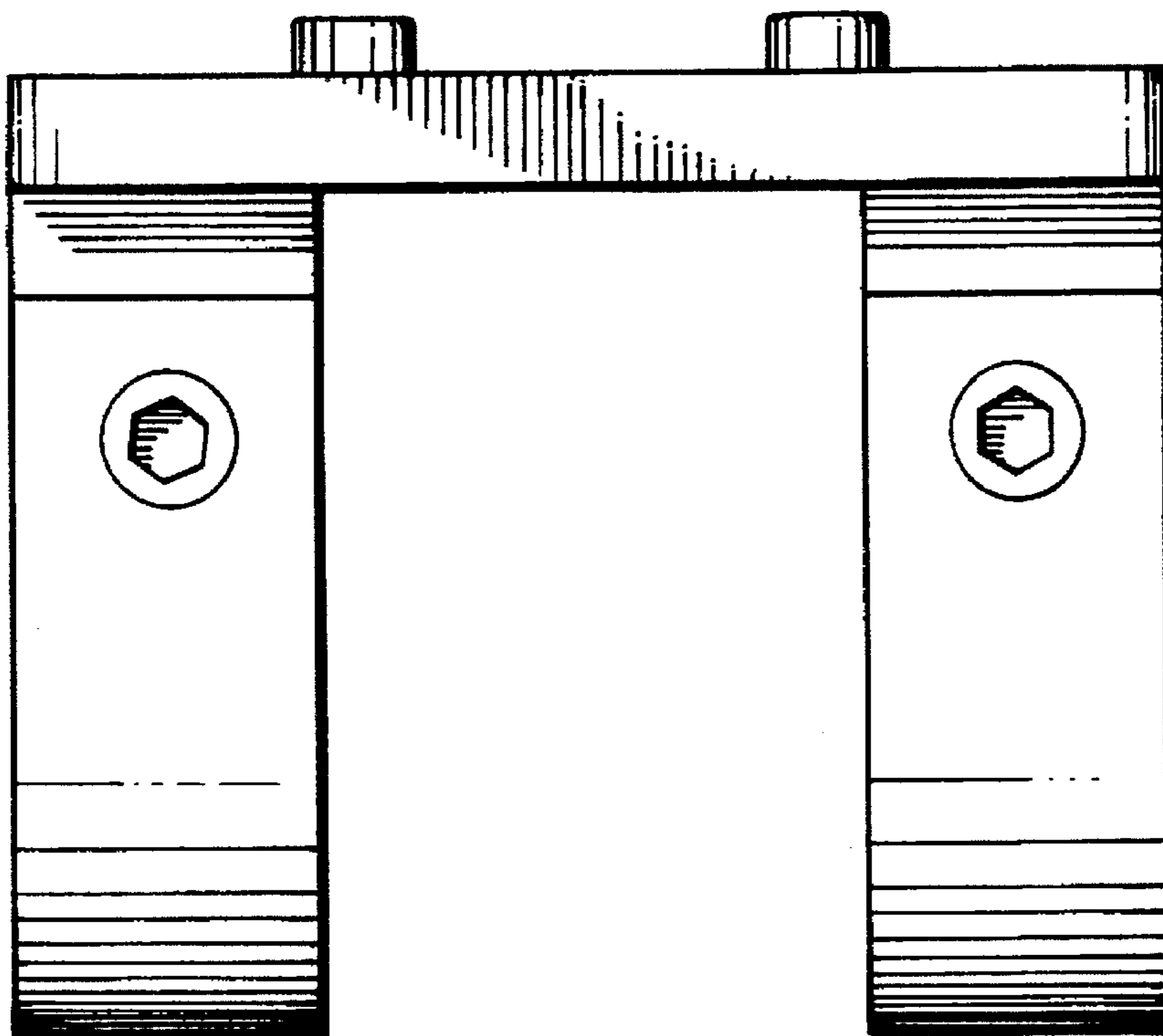

FIG. 7