



US00D381045S

United States Patent [19]
White

[11] **Patent Number:** **Des. 381,045**
[45] **Date of Patent:** ****Jul. 15, 1997**

[54] **DISPLAY STAND**
[75] **Inventor:** **Kennon A. White**, Advance, N.C.
[73] **Assignee:** **Season Ticket Collectibles, Inc.**,
Winston-Salem, N.C.
[**] **Term:** **14 Years**
[21] **Appl. No.:** **51,309**
[22] **Filed:** **Mar. 6, 1996**
[51] **LOC (6) Cl.** **20-03**
[52] **U.S. Cl.** **D20/19; D6/300; D6/314**
[58] **Field of Search** **D20/15, 10, 19,**
D20/29, 59; D19/91, 95; 211/133, 50; D6/310;
40/642, 120, 725, 124, 611, 584; 248/473

D. 367,561 3/1996 Kwan D6/310
4,268,985 5/1981 Lecznar 40/584 X
4,941,576 7/1990 Sugarman et al. 211/50 X
5,031,870 7/1991 Higgins 248/473

Primary Examiner—Susan J. Lucas
Assistant Examiner—Jennifer A. Register
Attorney, Agent, or Firm—Petree Stockton, LLP

[57] **CLAIM**

The ornamental design for display stand, as shown .

DESCRIPTION

FIG. 1 is a front elevational view of my new display stand;
FIG. 2 is a right end elevational view of the display stand of
FIG. 1;
FIG. 3 is a top plan view of the display stand of FIG. 1;
FIG. 4 is a bottom view of the display stand of FIG. 1;
FIG. 5 is rear elevational view of the display stand of FIG.
1; and,
FIG. 6 is a perspective view of the left end of the display
stand of FIG. 1.

[56] **References Cited**
U.S. PATENT DOCUMENTS
D. 248,777 8/1978 Anthony D19/91
D. 276,092 10/1984 Leo D19/91 X
D. 353,283 12/1994 Ford D6/449
D. 355,218 2/1995 Peterka D19/82

1 Claim, 1 Drawing Sheet

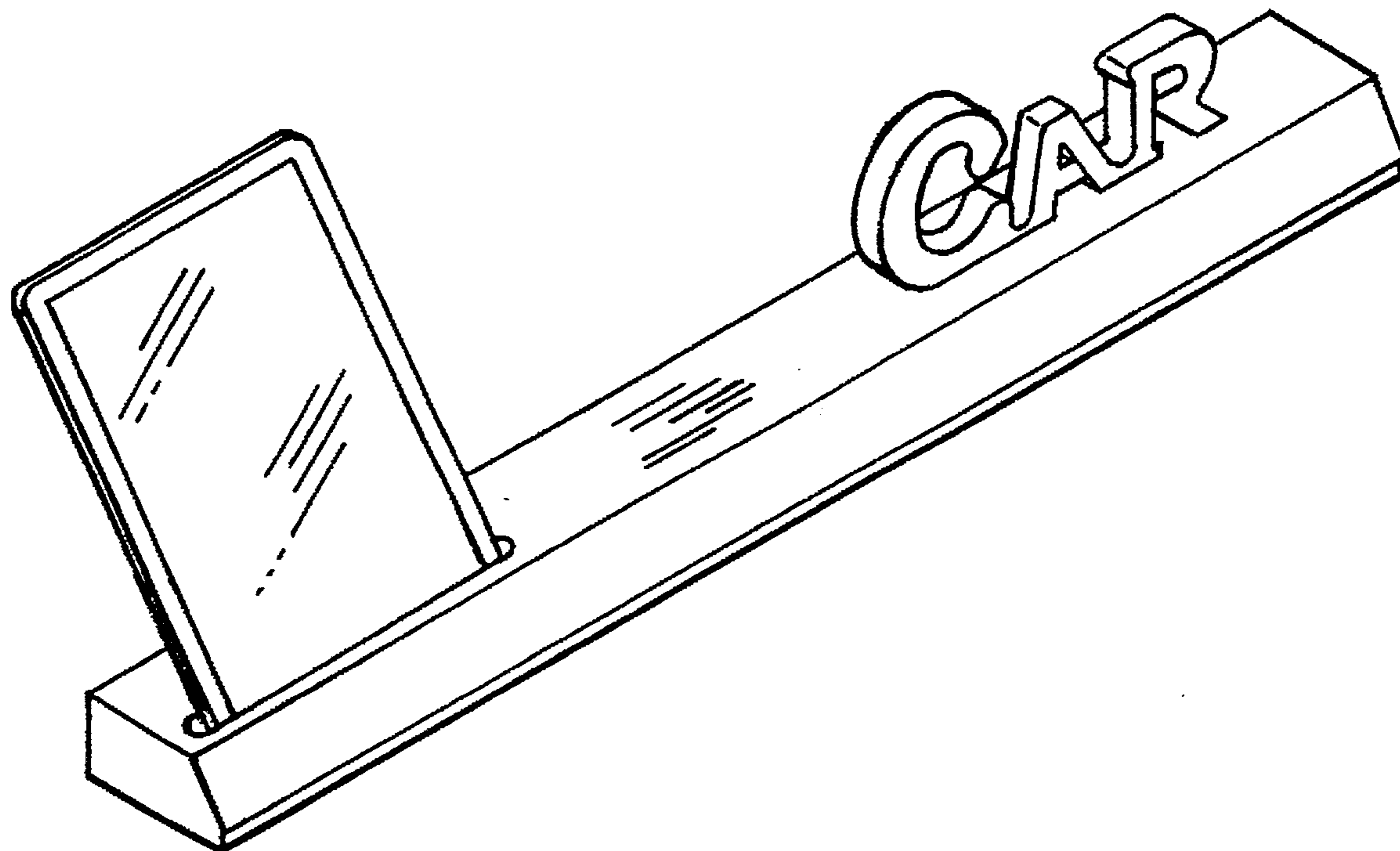

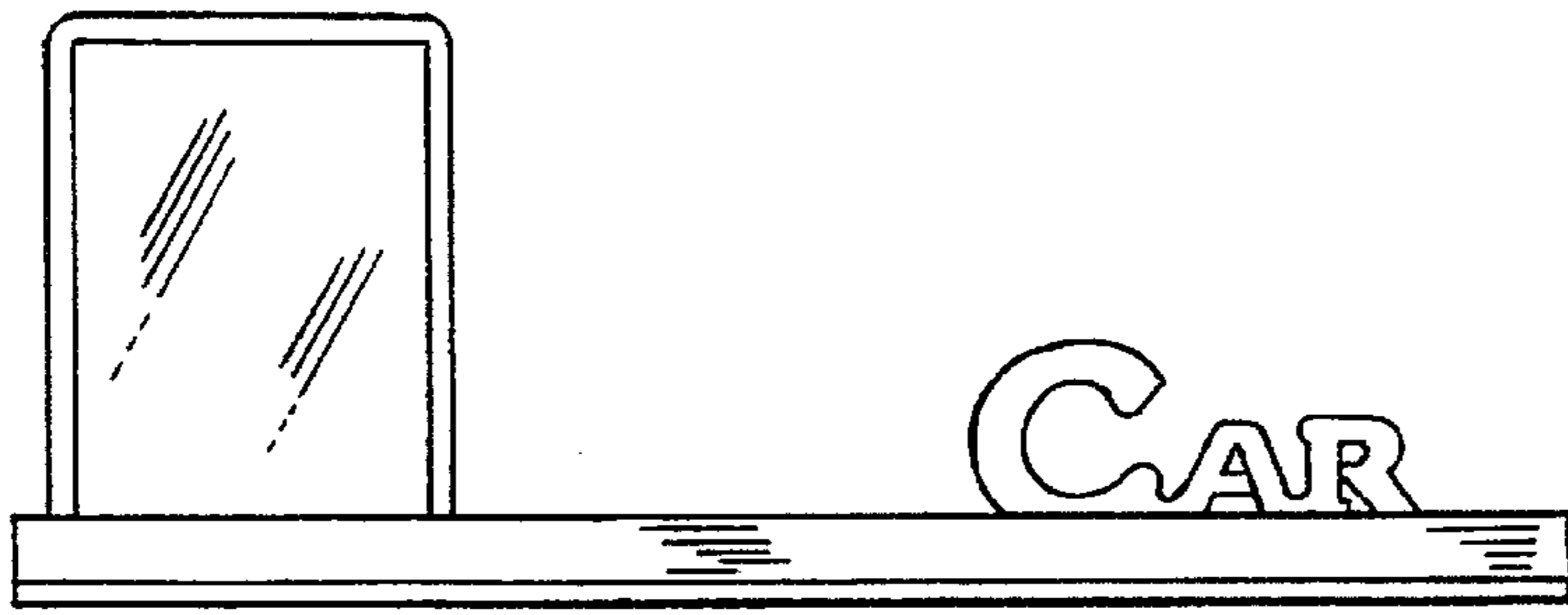

FIG. 1

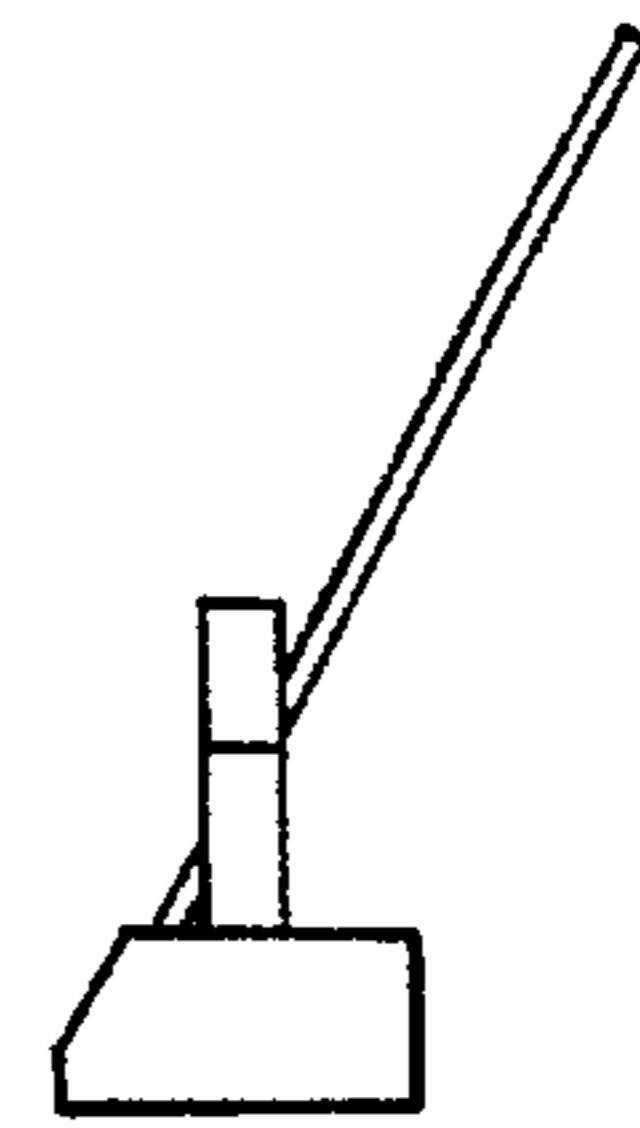

FIG. 2

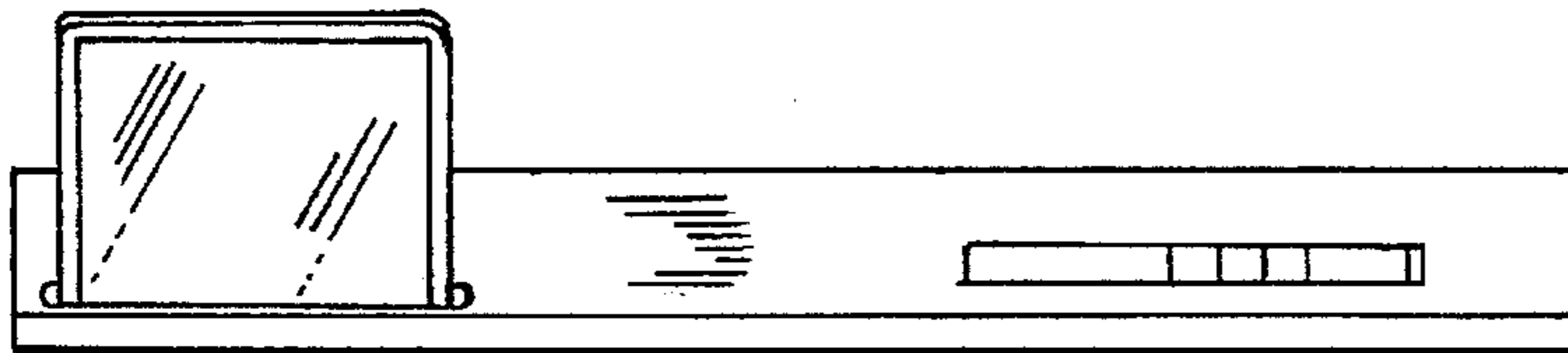

FIG. 3

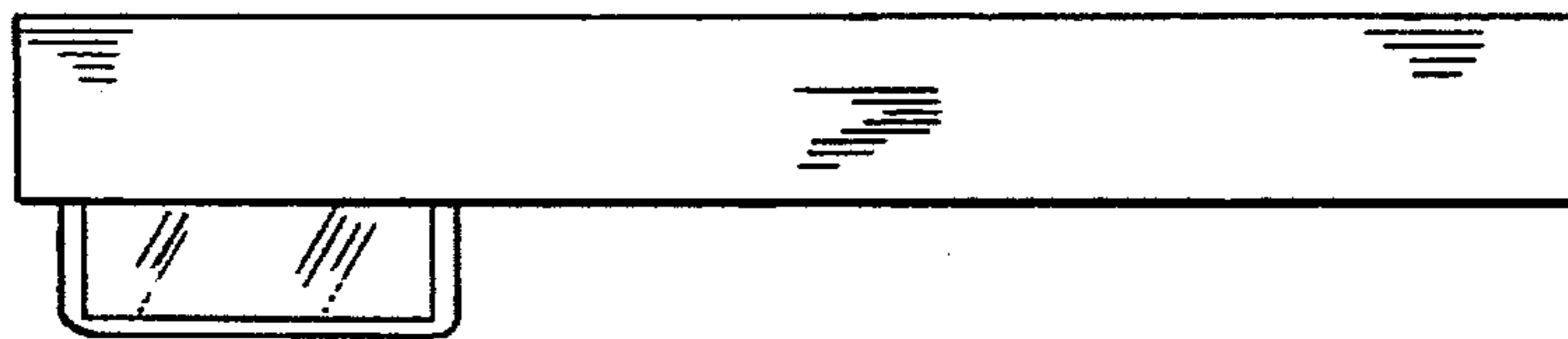

FIG. 4

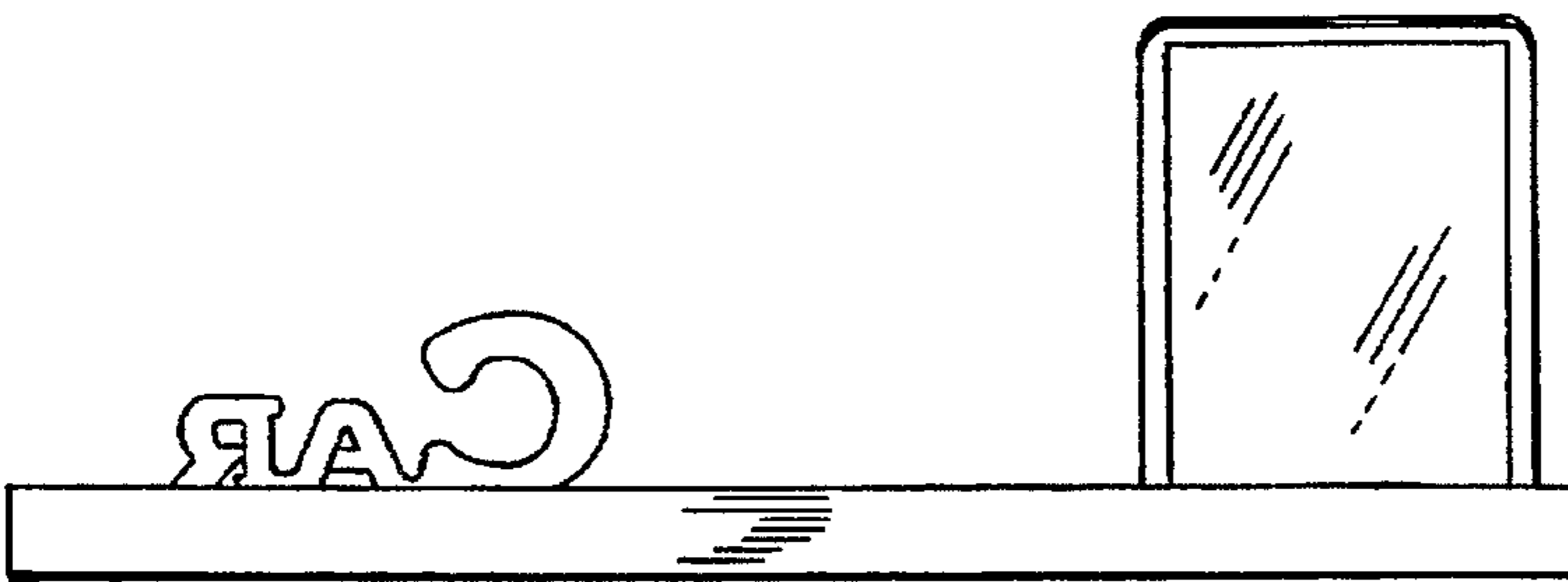

FIG. 5

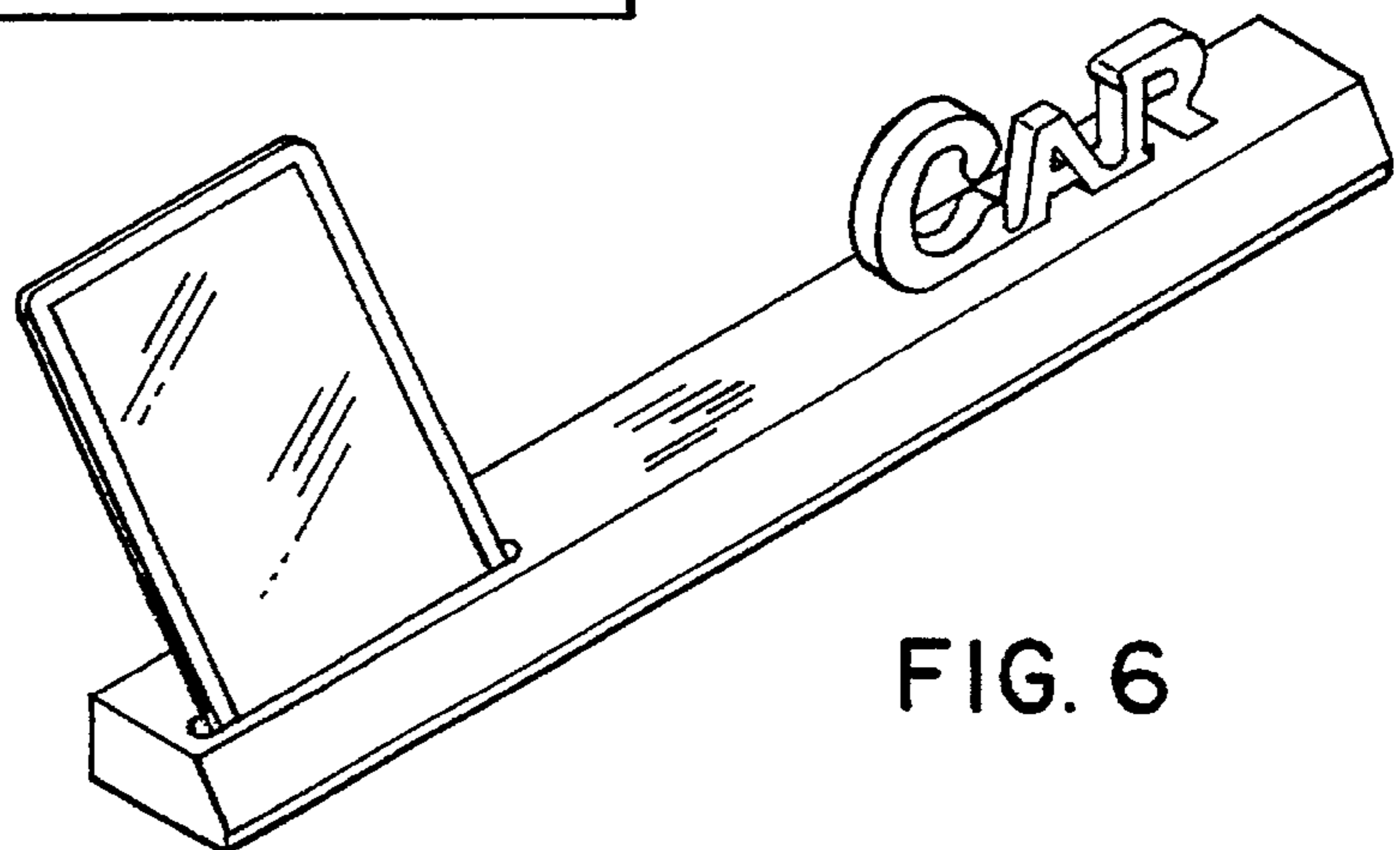

FIG. 6