



US00D381012S

United States Patent [19]

Esslinger et al.

[11] Patent Number: **Des. 381,012**

[45] Date of Patent: ****Jul. 15, 1997**

[54] DESKTOP COMPUTER

[75] Inventors: **Hartmut H. Esslinger**, Los Gatos; **Mark Friesen**, Palo Alto; **Gadi Amit**, Mountain View, all of Calif.

[73] Assignee: **Packard Bell Electronics, Inc.**, Westlake Village, Calif.

[**] Term: **14 Years**

[21] Appl. No.: **39,625**

[22] Filed: **Jun. 1, 1995**

[51] LOC (6) Cl. **14-02**

[52] U.S. Cl. **D14/100**

[58] Field of Search D14/100, 102, D14/107-109; D13/162, 184, 199; D6/432, 436, 445, 448; 312/208.1; 360/97.01, 97.04, 98.01; 361/694, 696; 369/34, 36

[56] References Cited

U.S. PATENT DOCUMENTS

D. 338,451	8/1993	Toedter	D14/100
D. 342,943	1/1994	Wettrin	D14/100
D. 344,070	2/1994	Gluskoter et al.	D14/100
D. 348,253	6/1994	Gluskoter	D14/100
D. 350,945	9/1994	Hill et al.	D14/109
D. 351,146	10/1994	Hill et al.	D14/109
D. 367,850	3/1996	Esslinger	D14/100
D. 370,208	5/1996	Esslinger	D14/100
D. 371,344	7/1996	Esslinger	D14/100

OTHER PUBLICATIONS

Canadian Industrial Design Registration No. 70,363 for a "Computer Case," registered Mar. 31, 1992 in the name of Elonex PLC.

Asian Sources Computer Products, Sunlan Electronics Corp. Advertisement, Oct. 1993, p. 223.

Primary Examiner—Freda Nunn

Attorney, Agent, or Firm—Wilson Sonsini Goodrich & Rosati

[57] CLAIM

The ornamental design for a desktop computer, as shown and described.

DESCRIPTION

FIG. 1 is a front elevation view of a desktop computer showing our new design;

FIG. 2 is a right side elevation thereof;

FIG. 3 is a left side elevation thereof;

FIG. 4 is a back elevation thereof;

FIG. 5 is a top plan view thereof; and,

FIG. 6 is a bottom plan view thereof;

FIG. 7 is a top, front, right side perspective view of a second embodiment thereof;

FIG. 8 is a front elevation thereof;

FIG. 9 is a right side elevation thereof;

FIG. 10 is a left side elevation thereof;

FIG. 11 is a back elevation thereof;

FIG. 12 is a top plan view thereof; and,

FIG. 13 is a bottom plan view thereof.

1 Claim, 13 Drawing Sheets

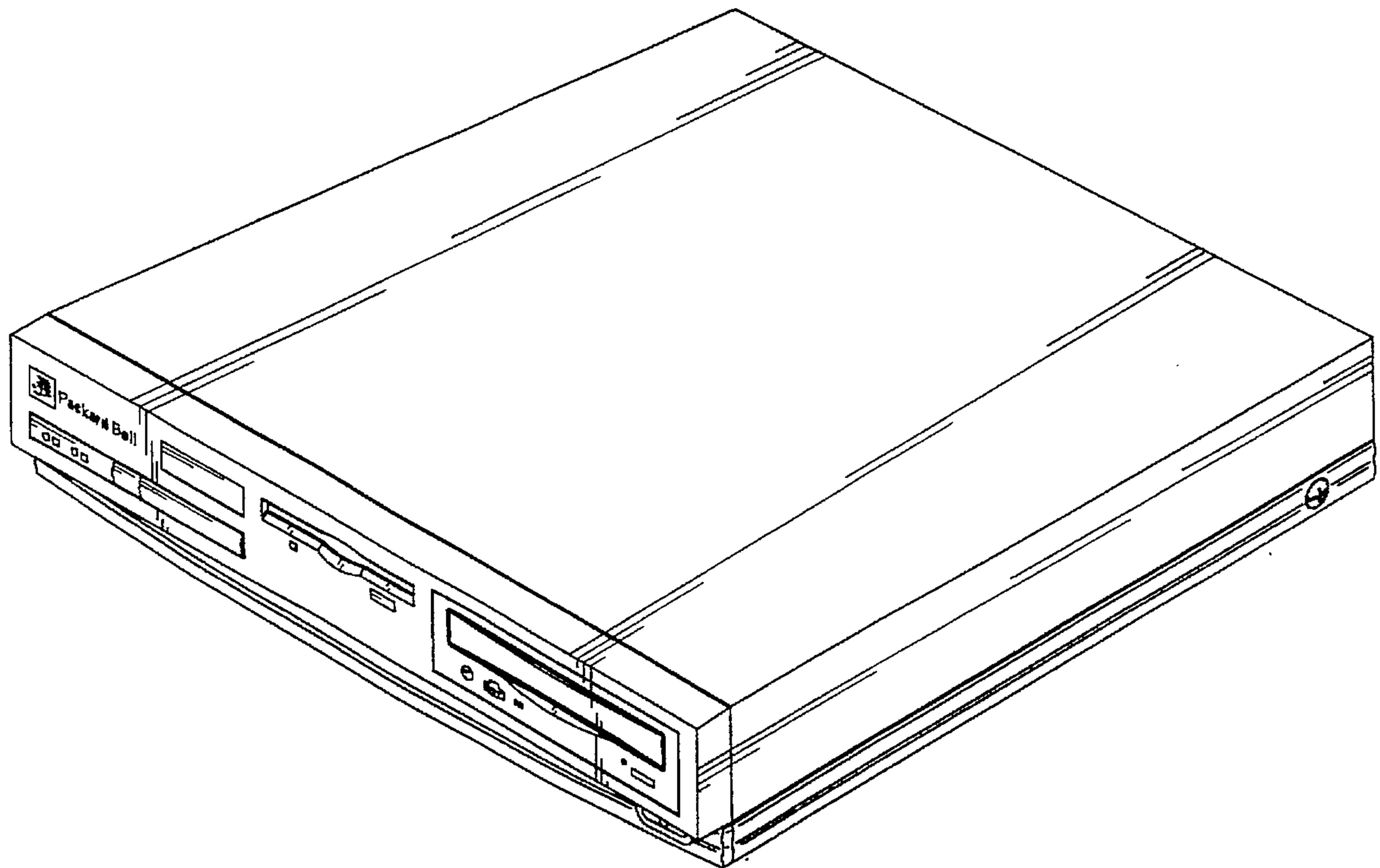

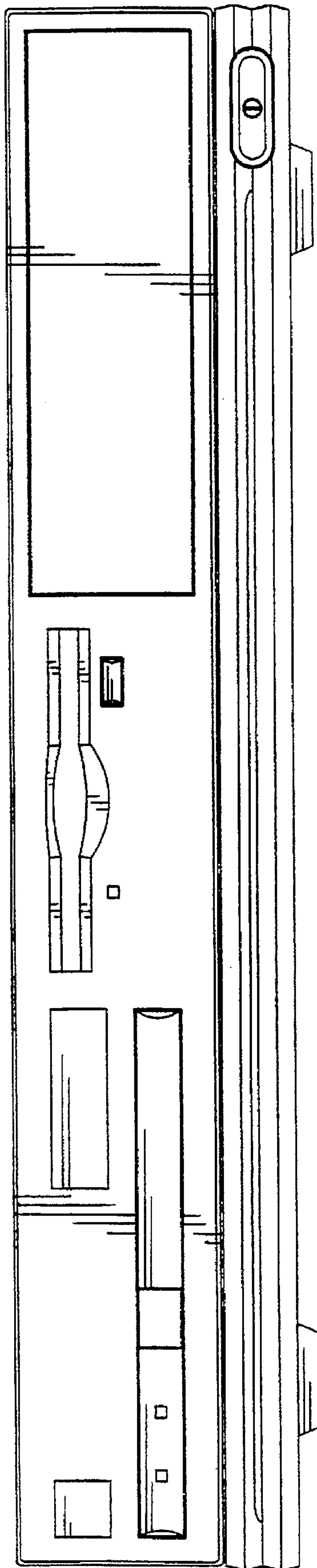

FIG. 1

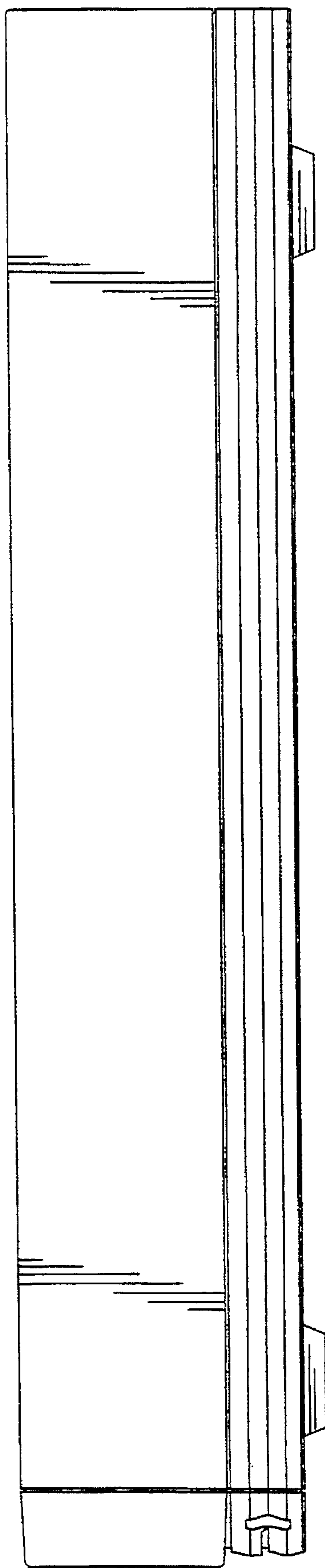

FIG. 2

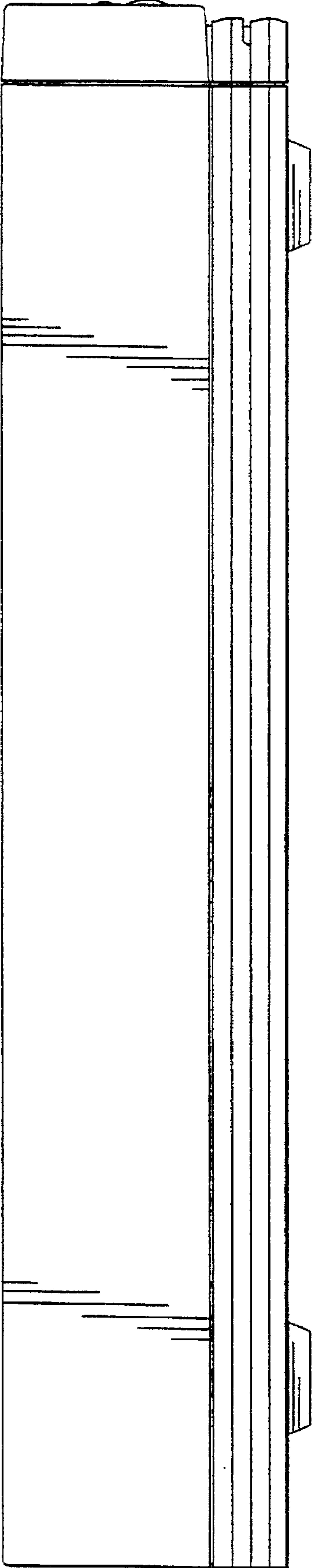

FIG. 3

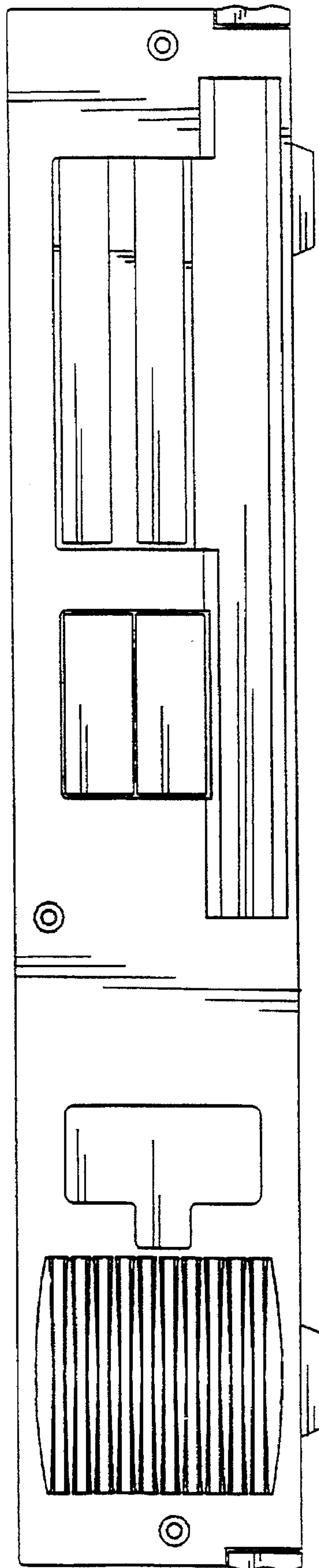

FIG. 4

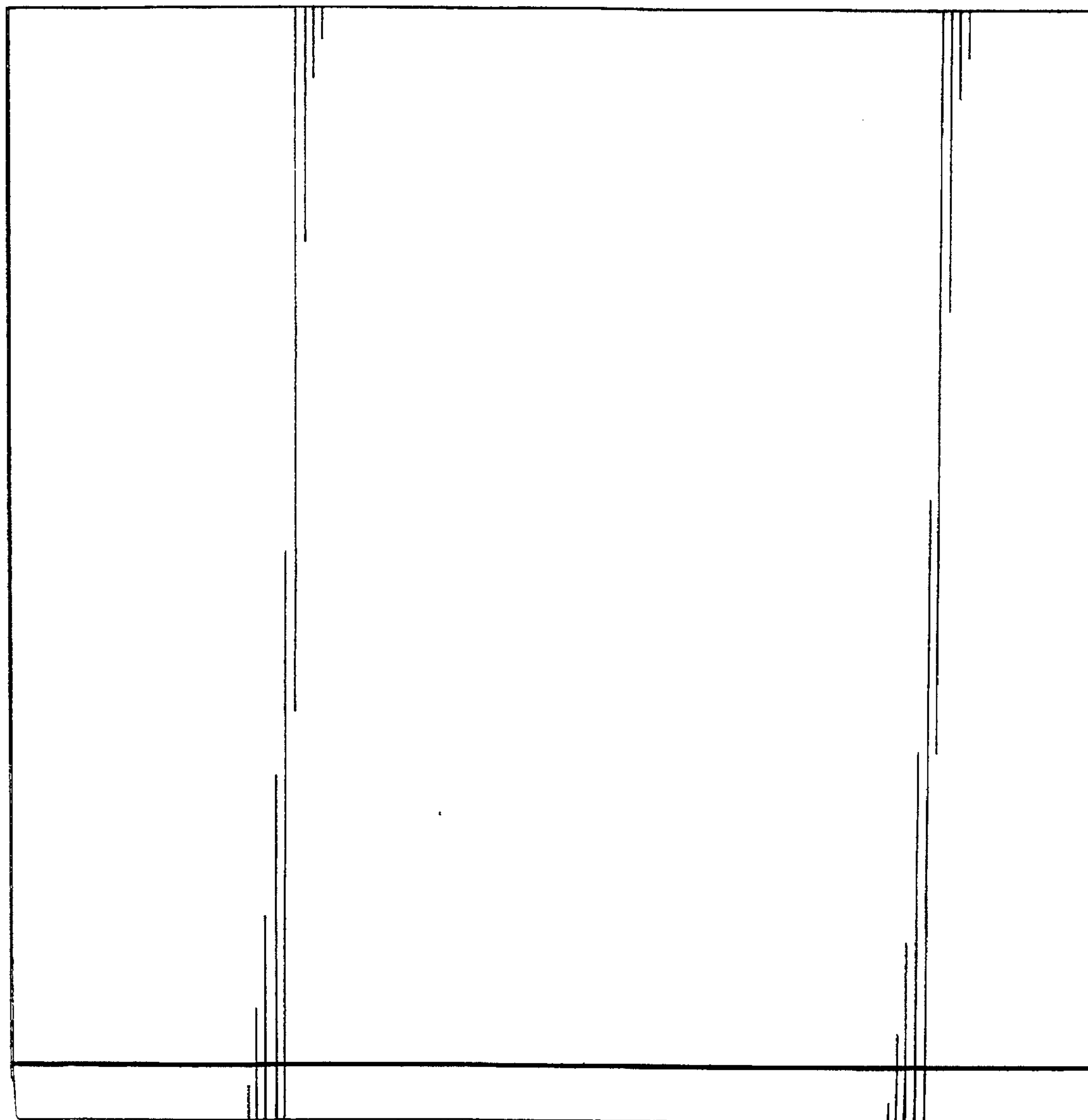

FIG. 5

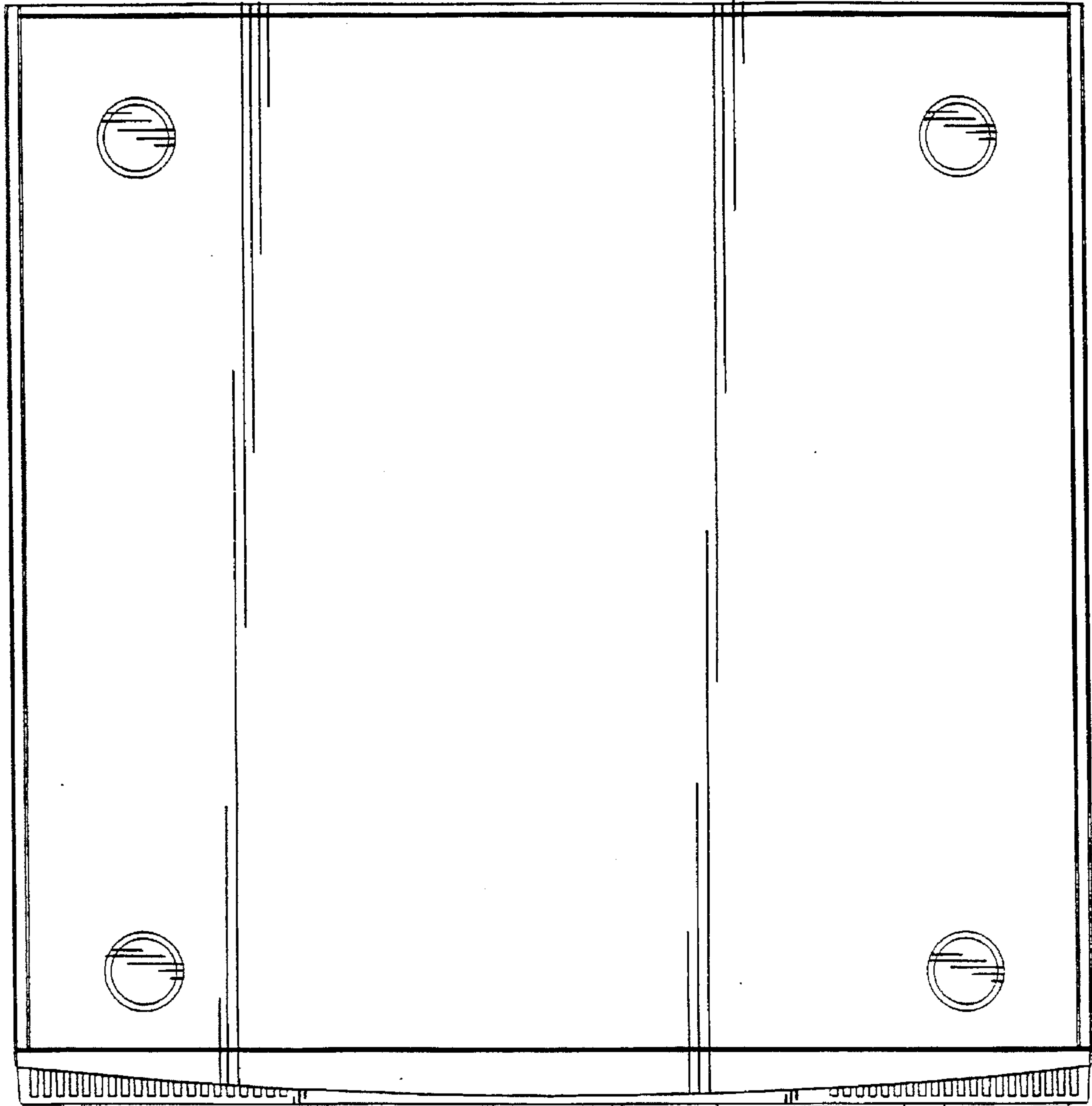

FIG. 6

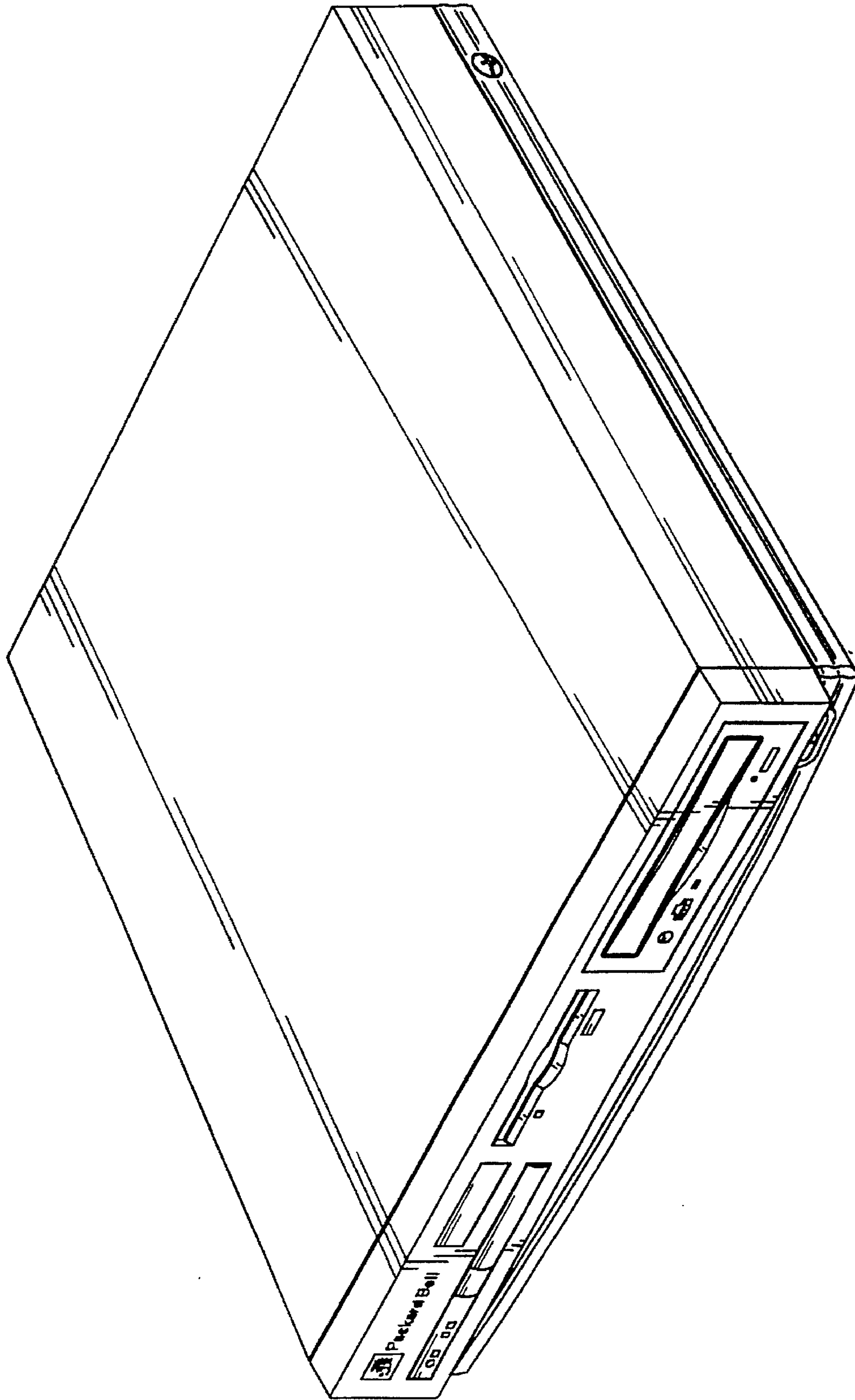

FIG. 7

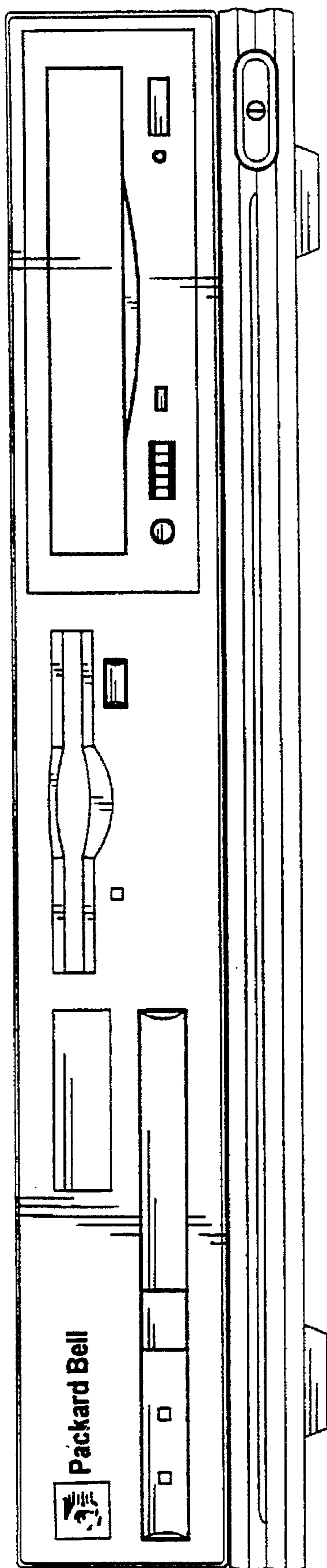

FIG. 8

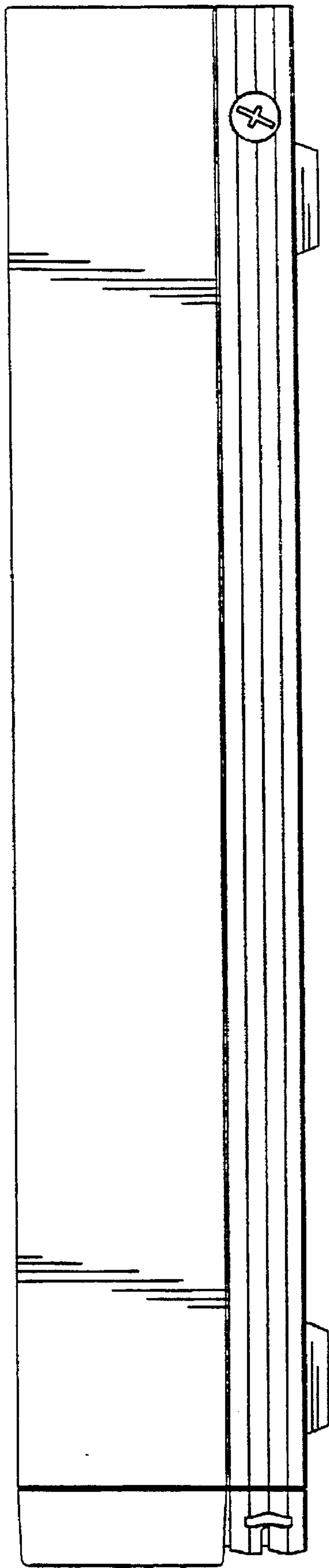

FIG. 9

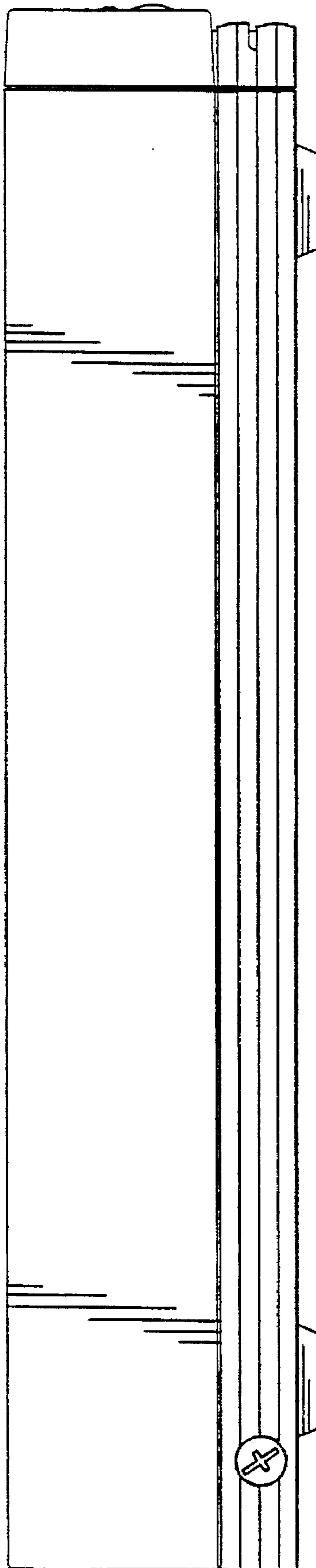

FIG. 10

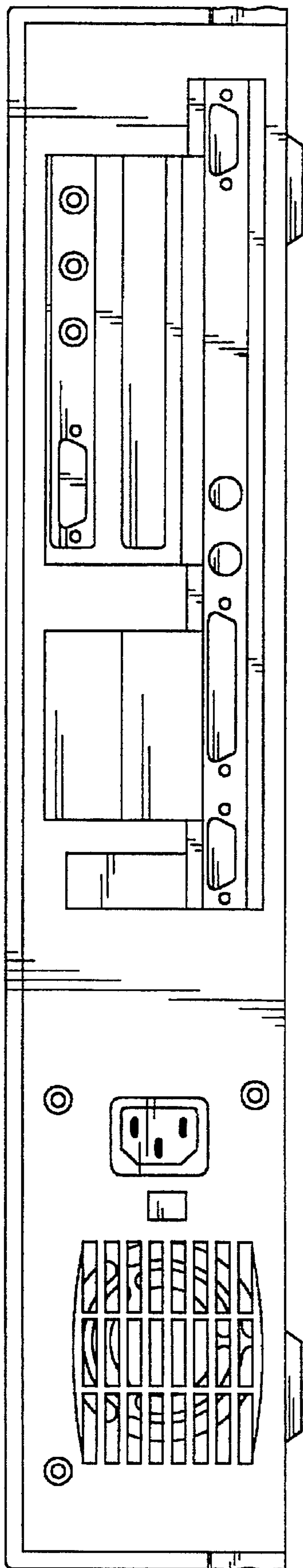

FIG. 11

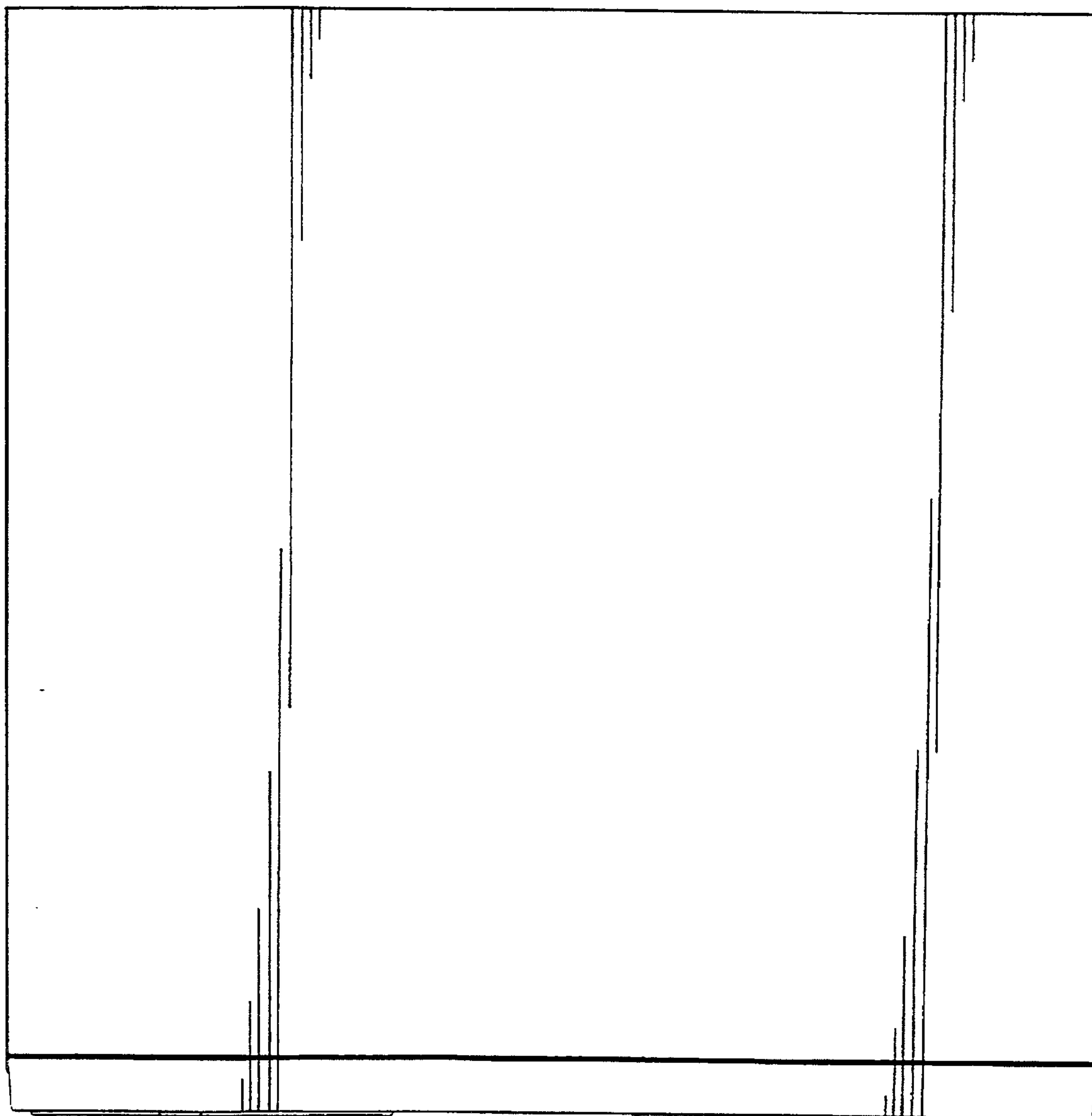

FIG. 12

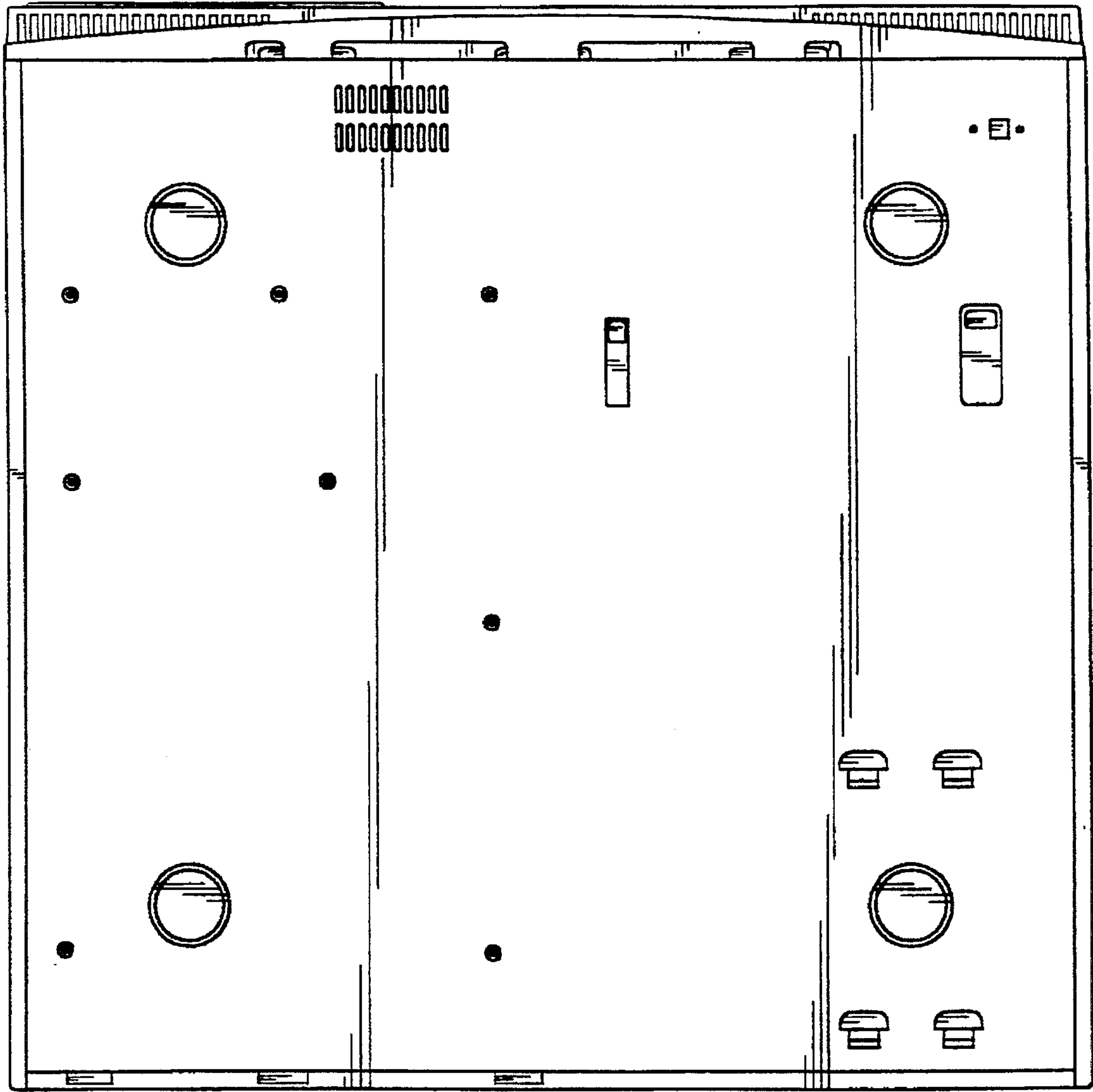

FIG. 13