



US00D380845S

United States Patent [19]
Chan

[11] **Patent Number: Des. 380,845**
[45] **Date of Patent: **Jul. 8, 1997**

[54] **LAMP**
[75] **Inventor: Kam-Hoi Chan, Kowloon Bay, Hong Kong**
[73] **Assignee: Go-Gro Industries Ltd., Kowloon Bay, Hong Kong**
[**] **Term: 14 Years**
[21] **Appl. No.: 49,766**
[22] **Filed: Jan. 30, 1996**
[30] **Foreign Application Priority Data**
Aug. 4, 1994 [HK] Hong Kong 95-3-08069.2
[51] **LOC (6) Cl. 26-02**
[52] **U.S. Cl. D26/43**
[58] **Field of Search D26/37-50; 362/157, 362/158, 184, 188, 189, 191, 198, 199, 200, 202, 362, 396**

2,092,672 9/1937 Hyatt D26/43

Primary Examiner—Marcus A. Jackson
Attorney, Agent, or Firm—Merchant, Gould, Smith, Edell, Welter & Schmidt, P.A.

[57] **CLAIM**

The ornamental design for a lamp, as shown and described.

DESCRIPTION

FIG. 1 is a perspective view of a lamp showing my new design;
FIG. 2 is a front elevational view thereof;
FIG. 3 is a rear elevational view thereof;
FIG. 4 is a right side elevational view thereof;
FIG. 5 is a left side elevational view thereof;
FIG. 6 is a top plan view thereof;
FIG. 7 is a bottom plan view thereof;
FIG. 8 is a perspective view of a second embodiment thereof, wherein the only difference resides in the gooseneck position which has been added; and,
FIG. 9 is a perspective view of a third embodiment thereof, wherein the only difference resides in a longer extended gooseneck position.

[56] **References Cited**

U.S. PATENT DOCUMENTS

D. 370,542 6/1996 Santarsiers D26/43
D. 370,735 6/1996 De Blois D26/43

1 Claim, 8 Drawing Sheets

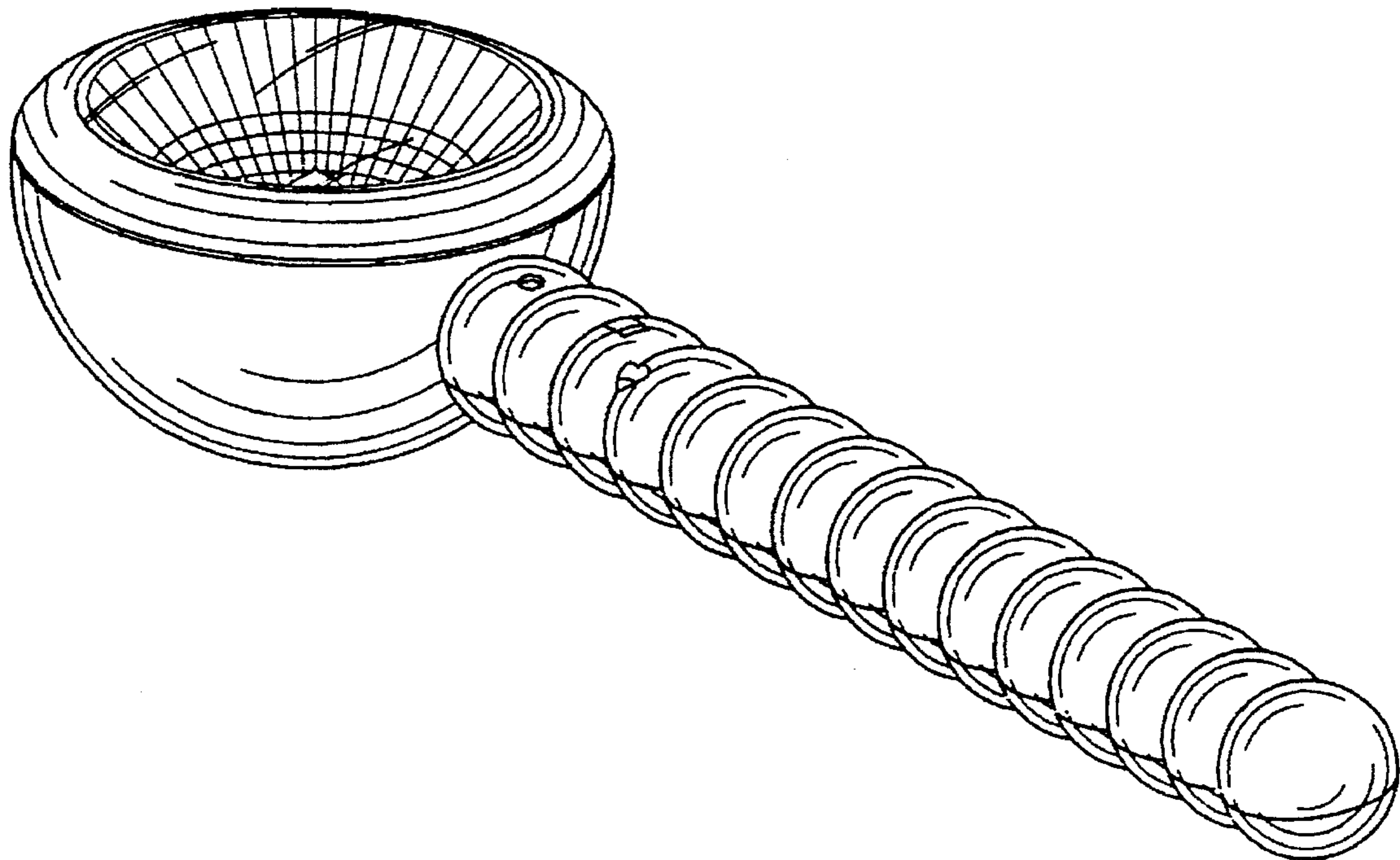

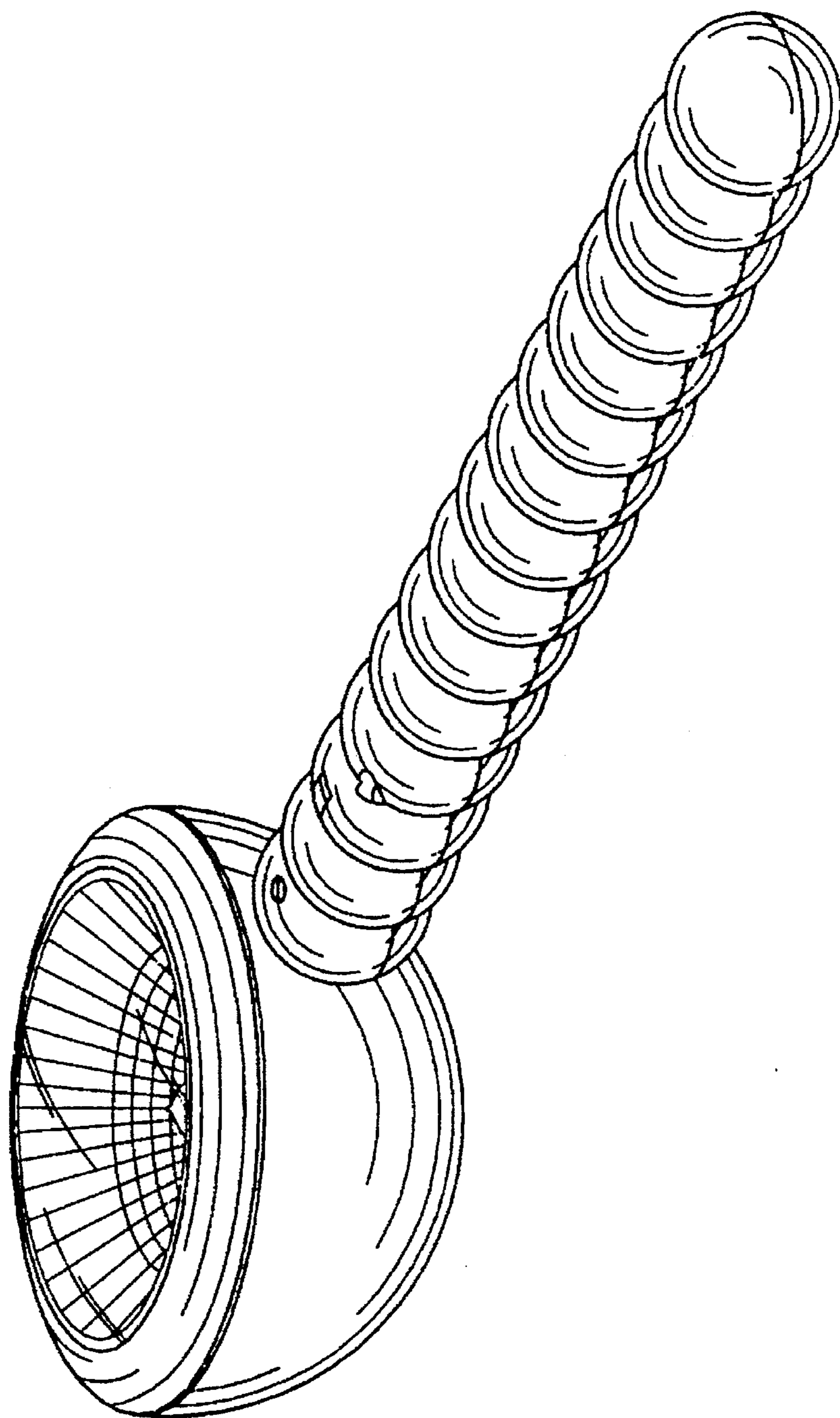

FIG. 1

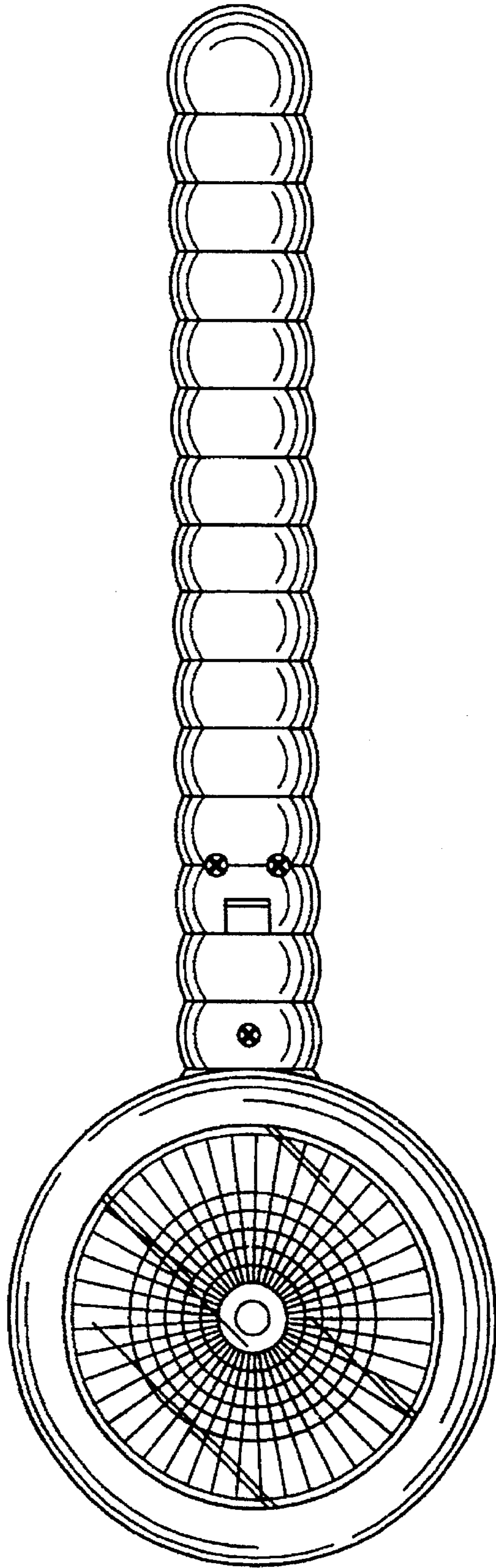

FIG. 2

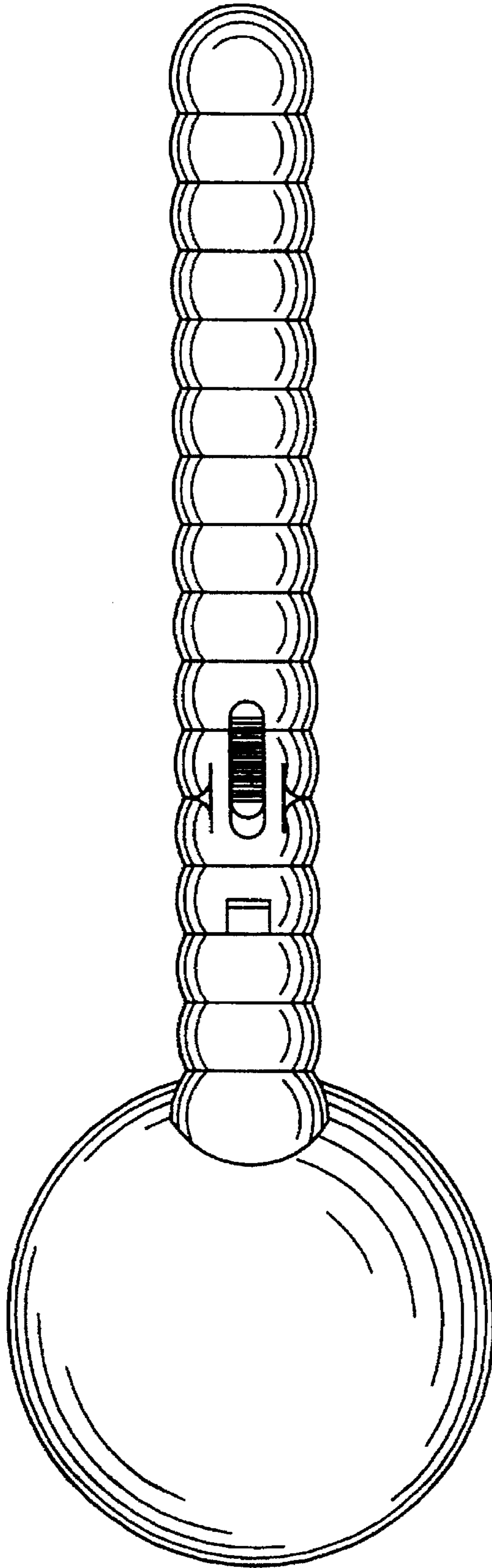

FIG. 3

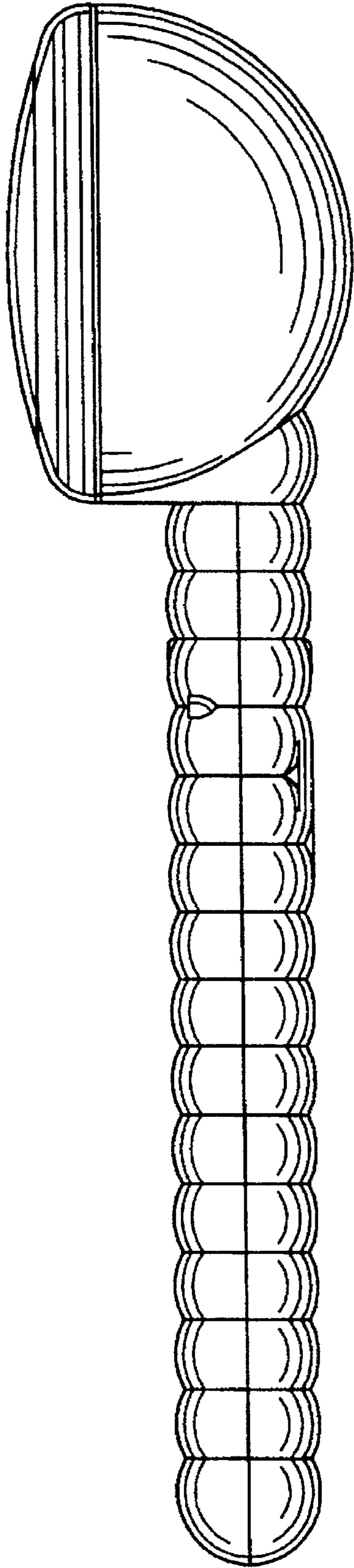

FIG. 4

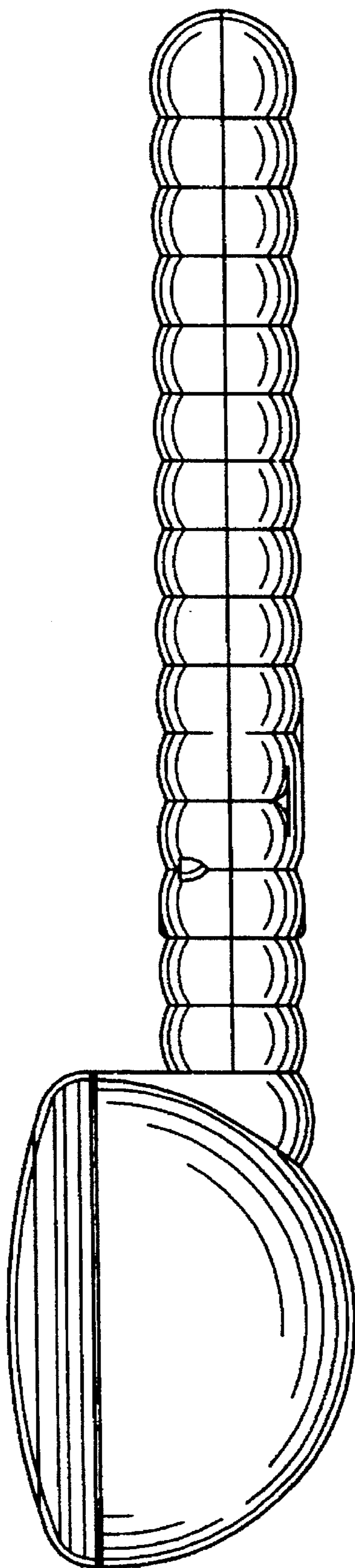

FIG. 5

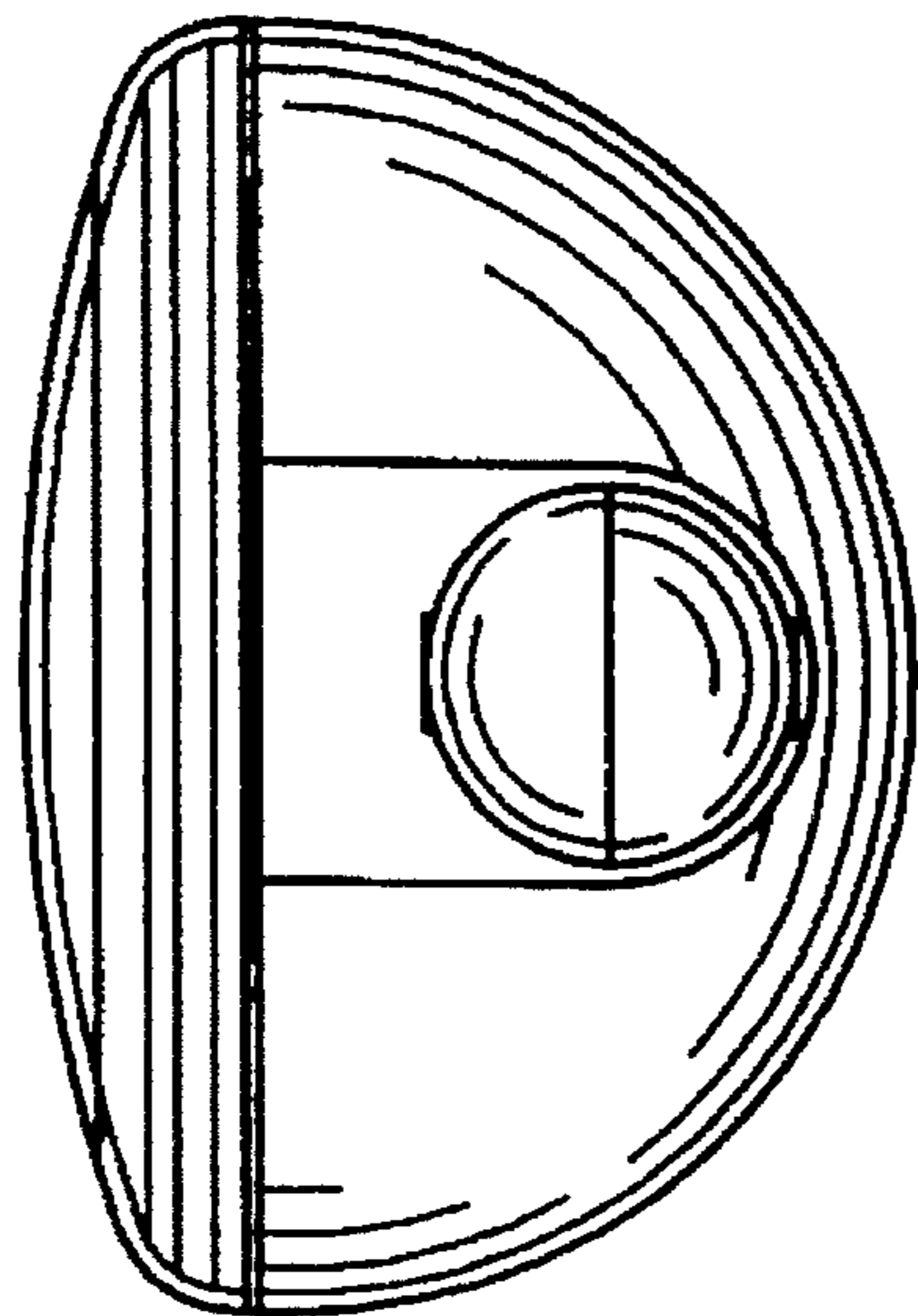

FIG. 6

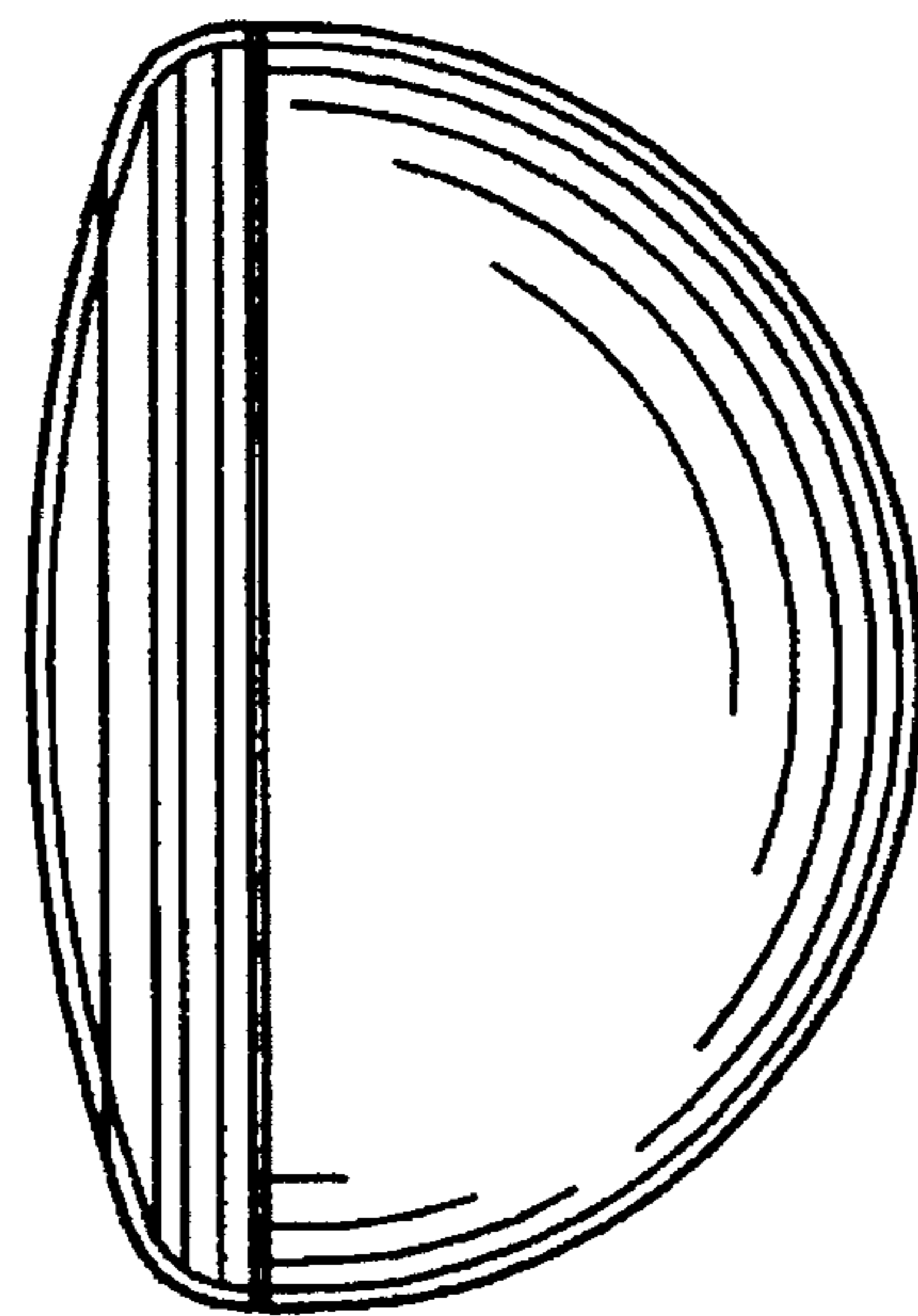

FIG. 7

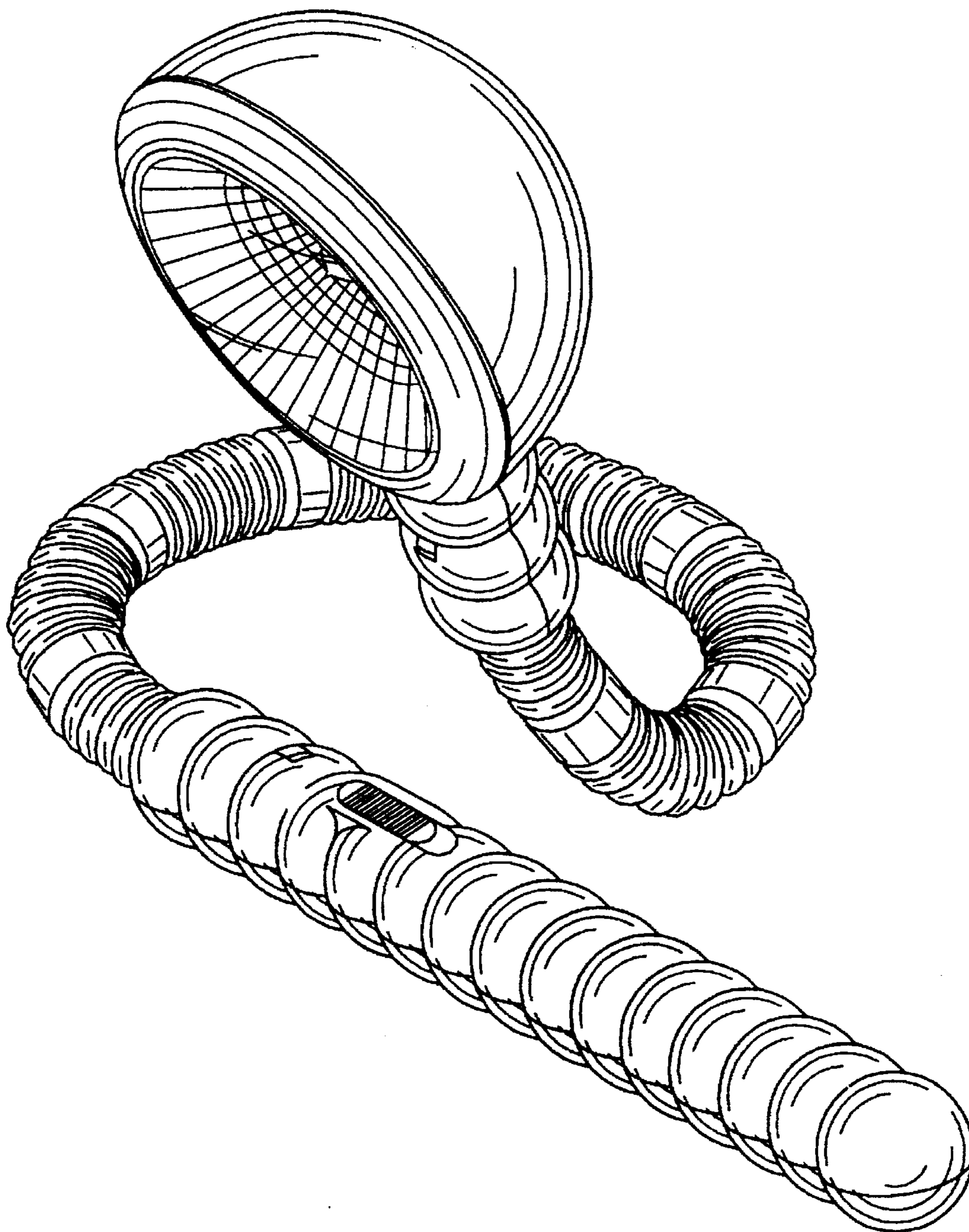

FIG. 8

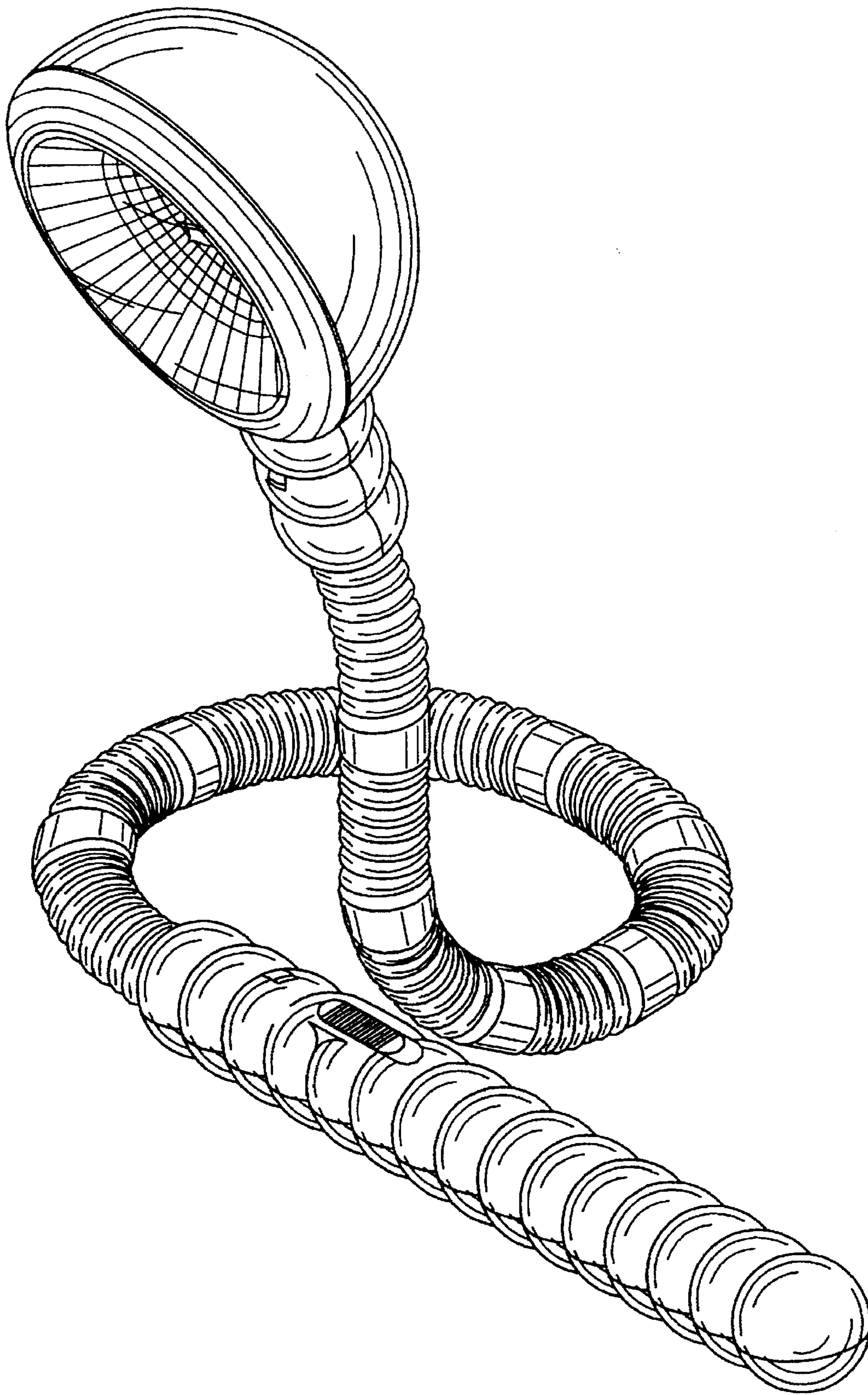

FIG. 9