



US00D380836S

United States Patent [19]

Fitzpatrick et al.

[11] Patent Number: **Des. 380,836**

[45] Date of Patent: ****Jul. 8, 1997**

[54] **PACIFIER**

[75] Inventors: **William E. Fitzpatrick**, Wyckoff, N.J.;
Aidan J. Petrie, Providence, R.I.

[73] Assignee: **Playtex Products, Inc.**, Westport,
Conn.

[**] Term: **14 Years**

[21] Appl. No.: **49,123**

[22] Filed: **Jan. 18, 1996**

[51] LOC (6) Cl. **24-04**

[52] U.S. Cl. **D24/194**

[58] Field of Search D24/194, 193,
D24/196; 606/234, 235, 236

[56] References Cited

U.S. PATENT DOCUMENTS

D. 267,116	11/1982	Bubelis	D24/194
D. 334,064	3/1993	Fitzpatrick	D24/194
3,267,937	8/1966	Verschoor	606/236

Primary Examiner—Stella Reid

Attorney, Agent, or Firm—Ohlandt, Greeley, Ruggiero & Perle

[57] CLAIM

The ornamental design for a pacifier, as shown and described.

DESCRIPTION

FIG. 1 is a perspective view of a first embodiment of a pacifier showing our new design;
 FIG. 2 is a front view of the pacifier shown in FIG. 1;
 FIG. 3 is a back view of the pacifier shown in FIG. 1;
 FIG. 4 is a top view of the pacifier shown in FIG. 1;
 FIG. 5 is a bottom view of the pacifier shown in FIG. 1;
 FIG. 6 is a side elevational view of the pacifier shown in FIG. 1 with the side opposite being identical to the side shown;
 FIG. 7 is a perspective view of a second embodiment of a pacifier showing our new design;
 FIG. 8 is a top view of the pacifier shown in FIG. 7; and,
 FIG. 9 is a side elevational view of the pacifier shown in FIG. 7 with the side opposite being identical to the side shown.

1 Claim, 3 Drawing Sheets

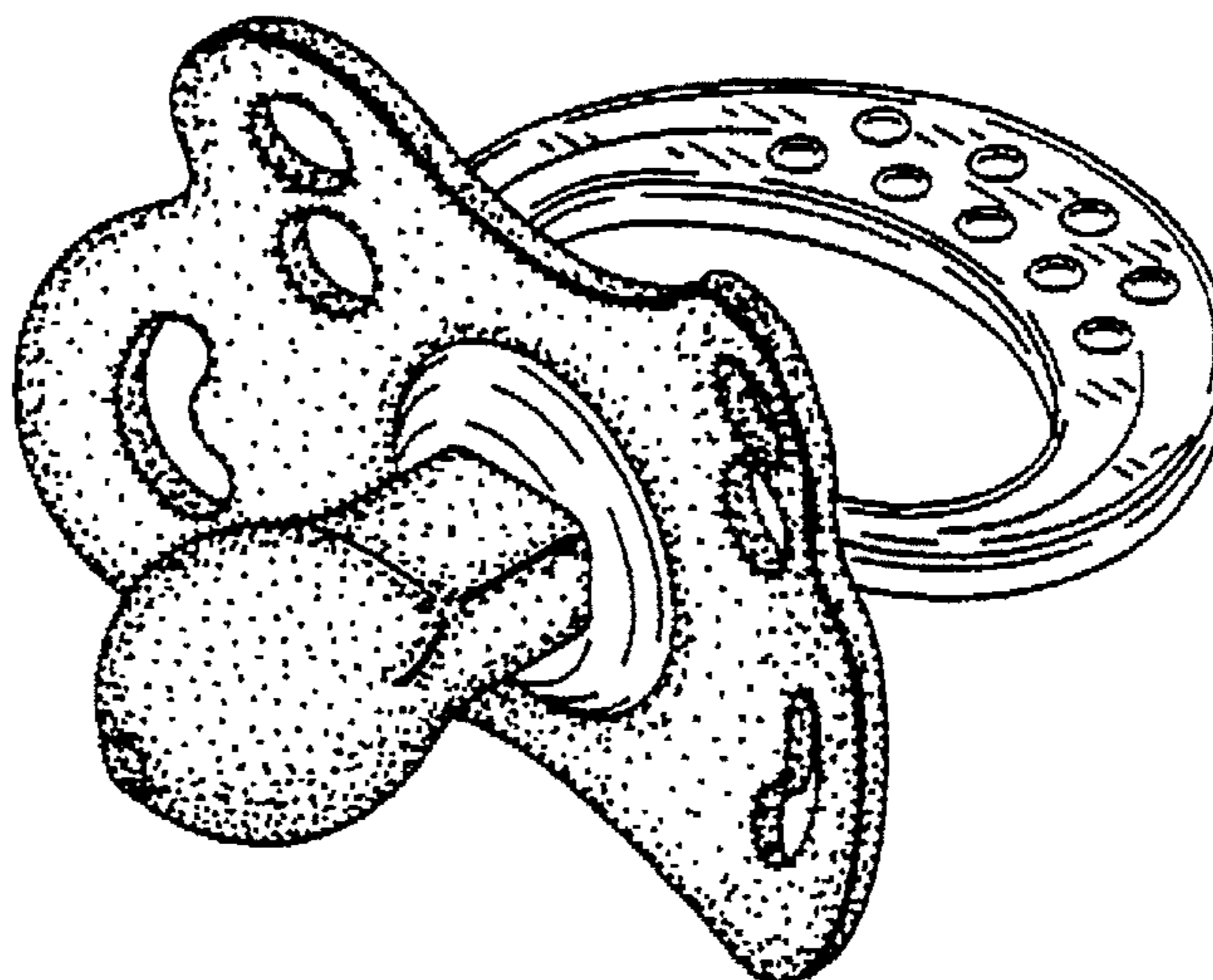

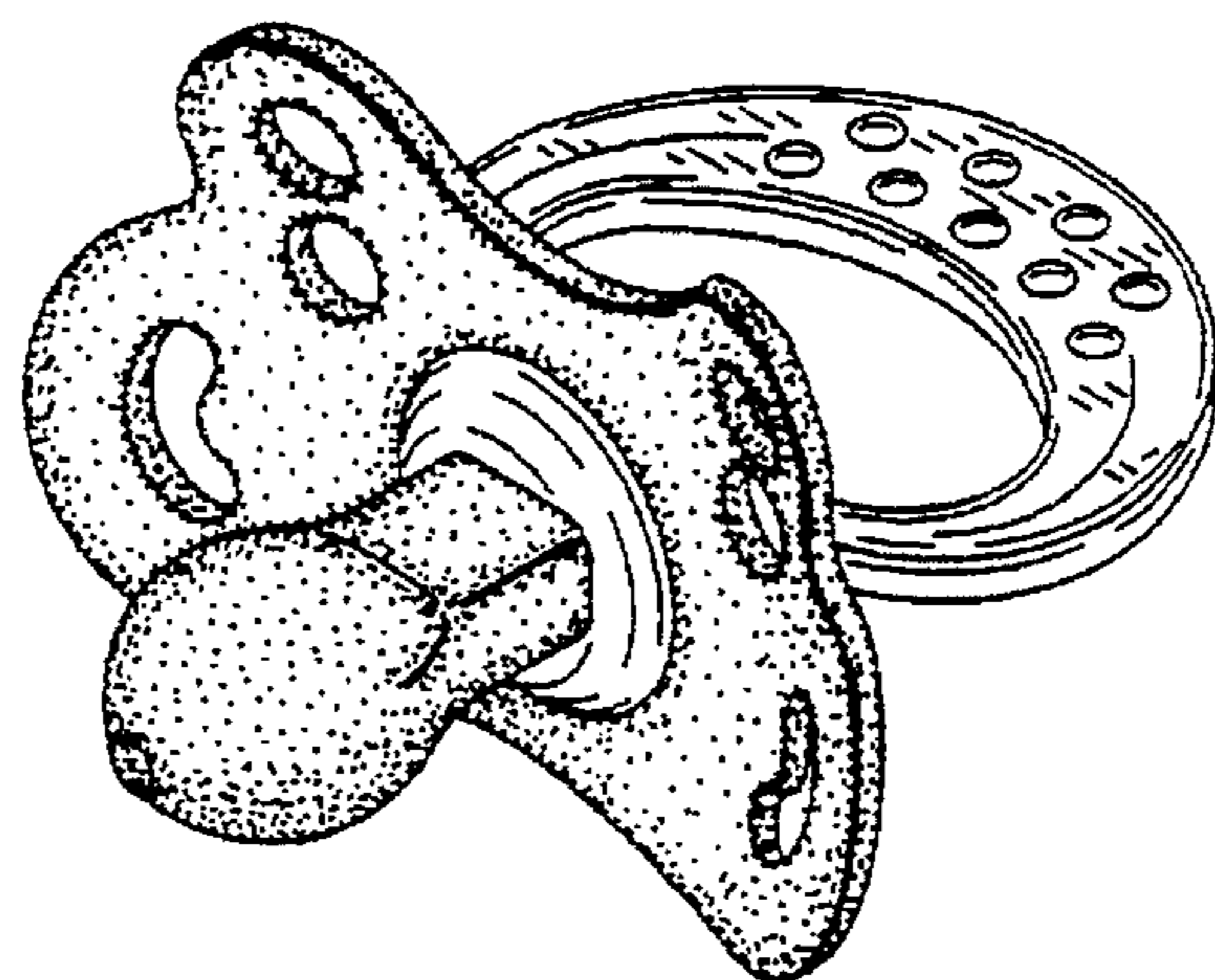

FIG. 1

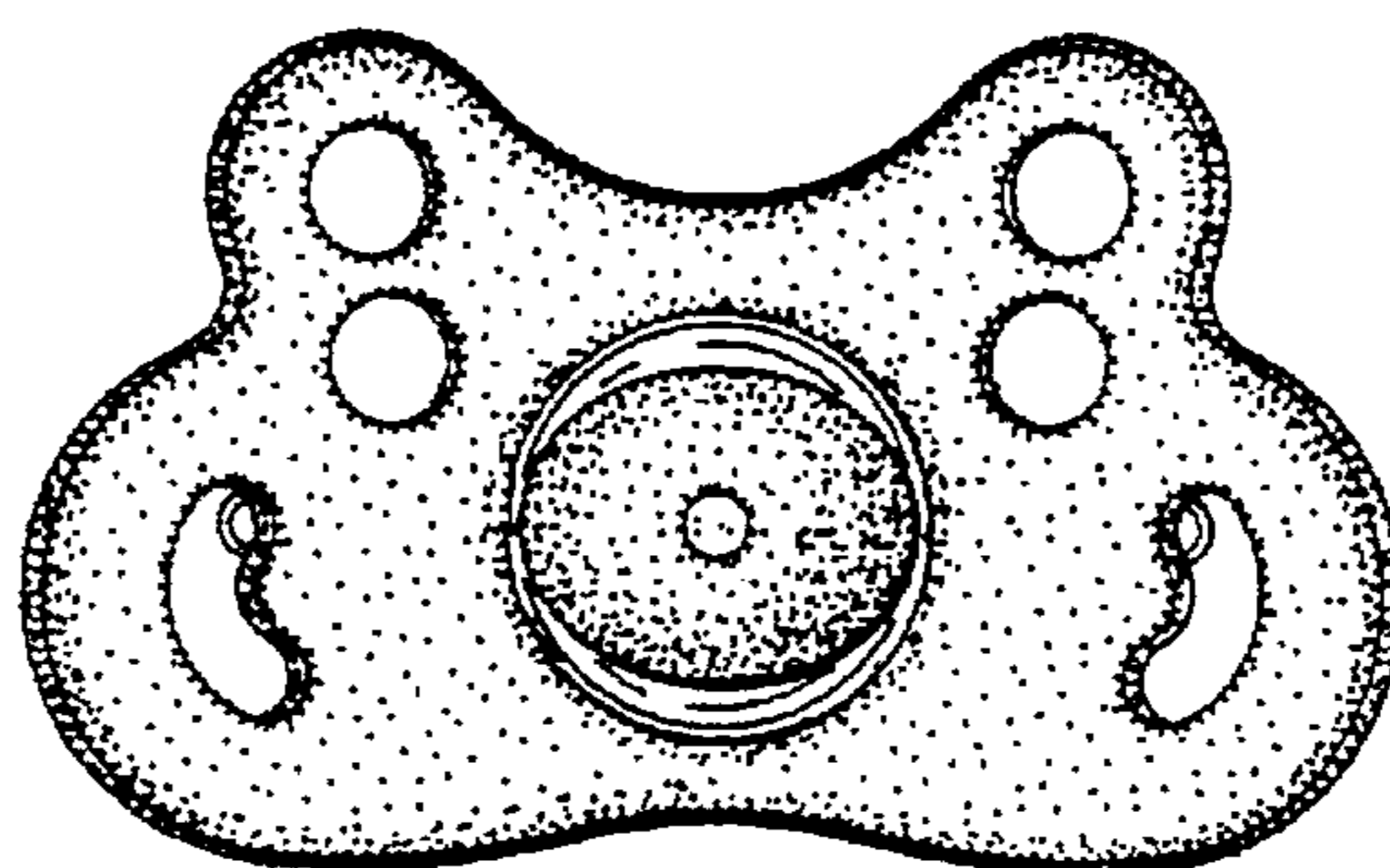

FIG. 2

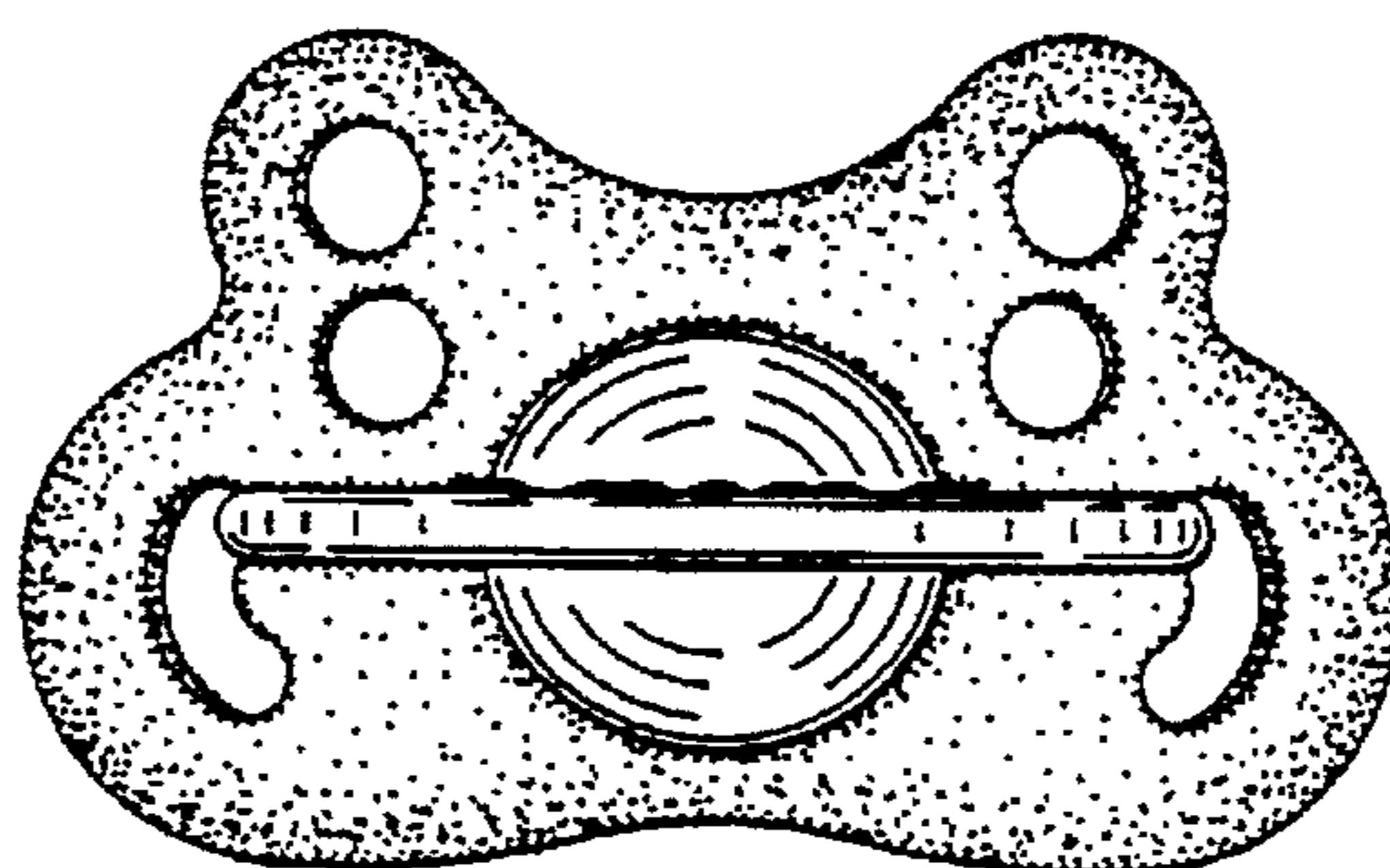

FIG. 3

FIG. 4

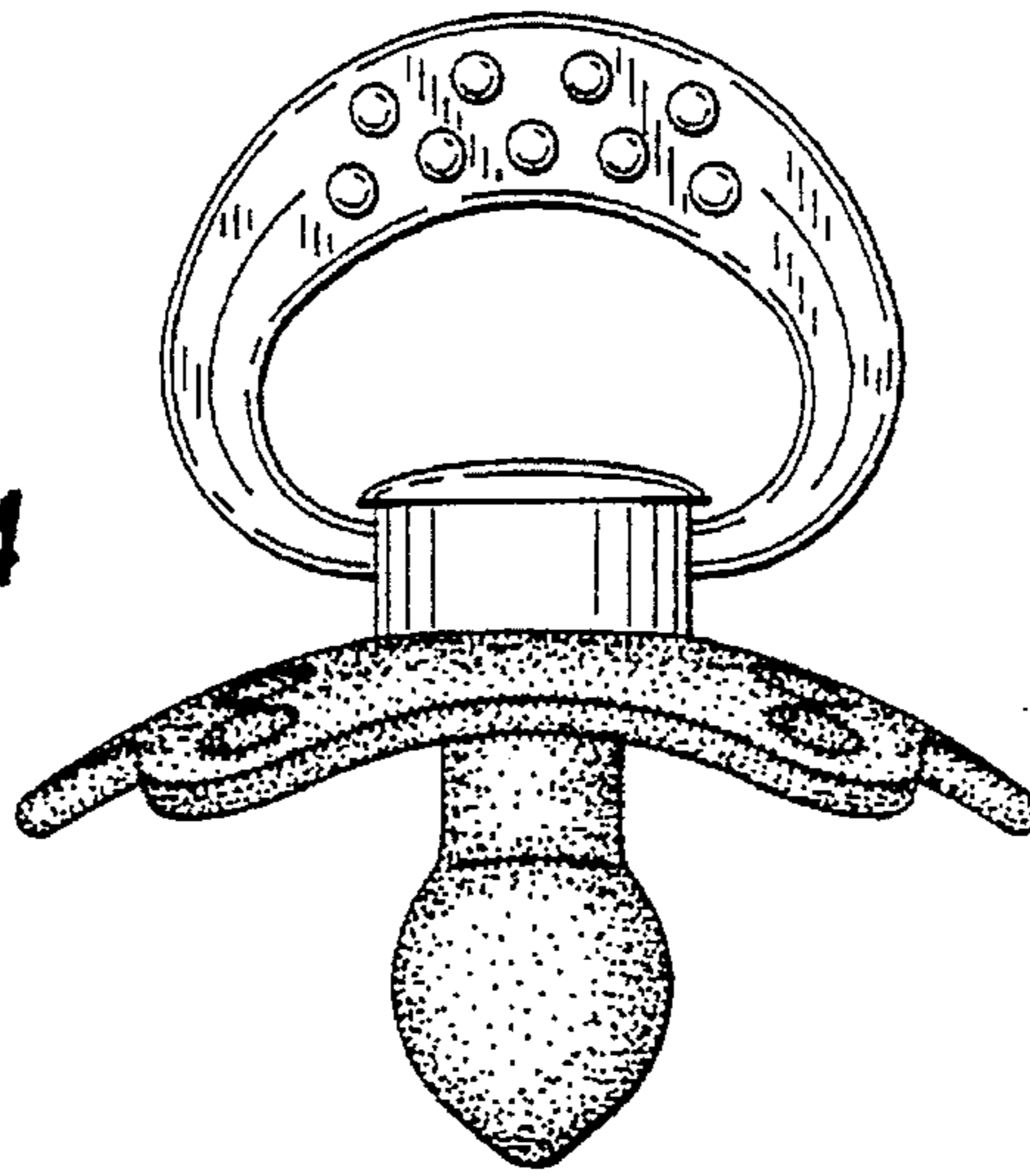

FIG. 5

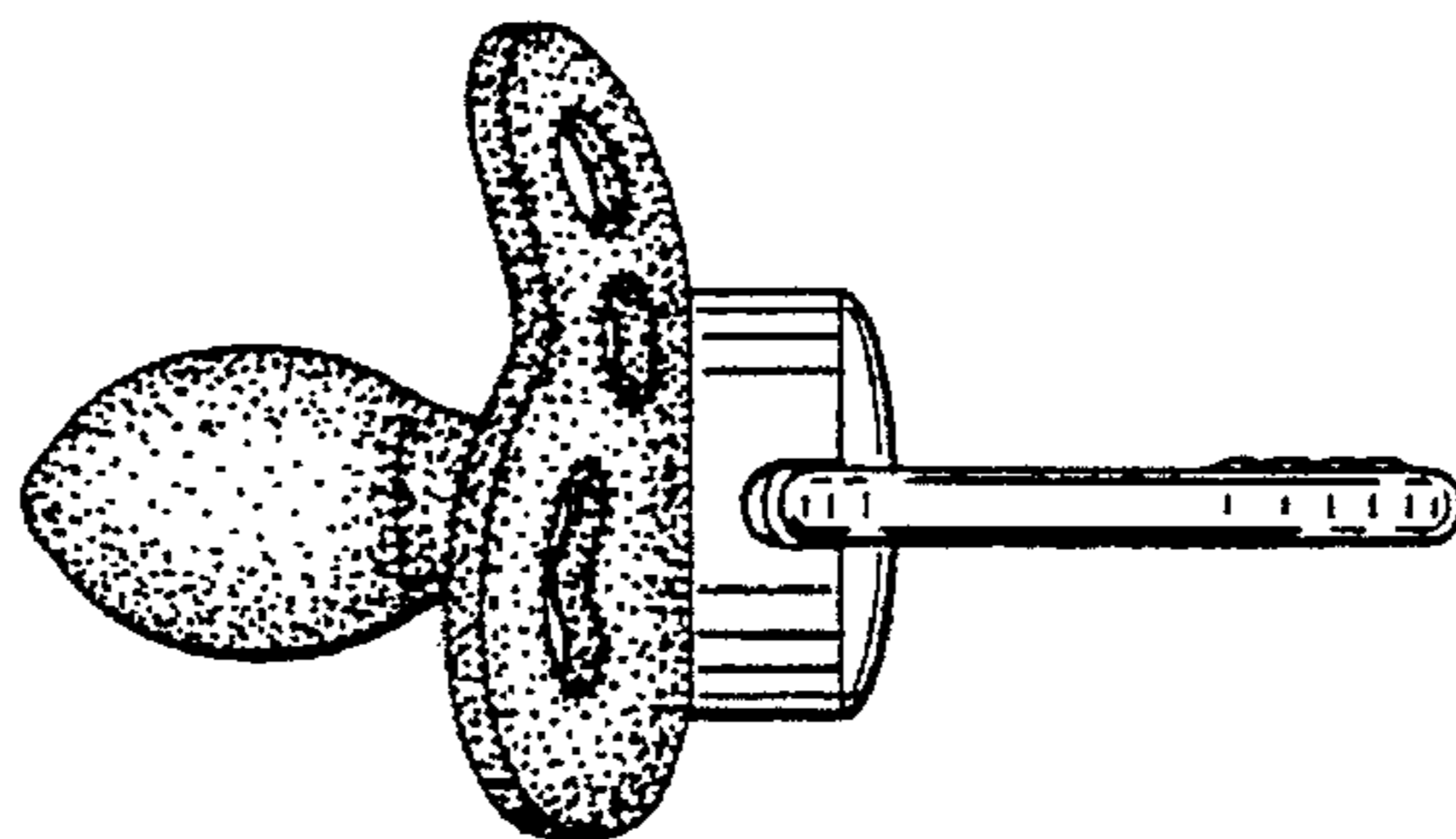
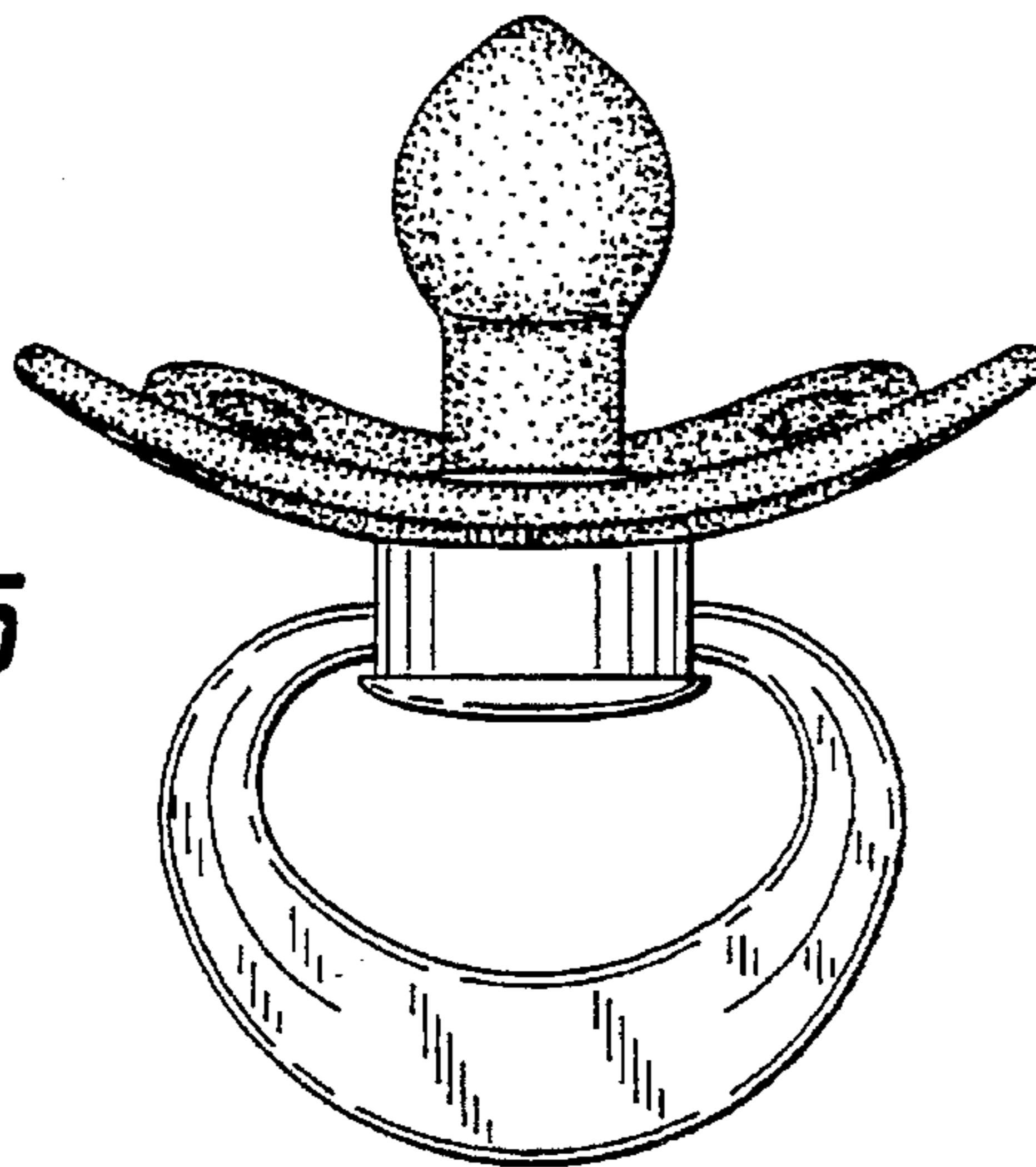

FIG. 6

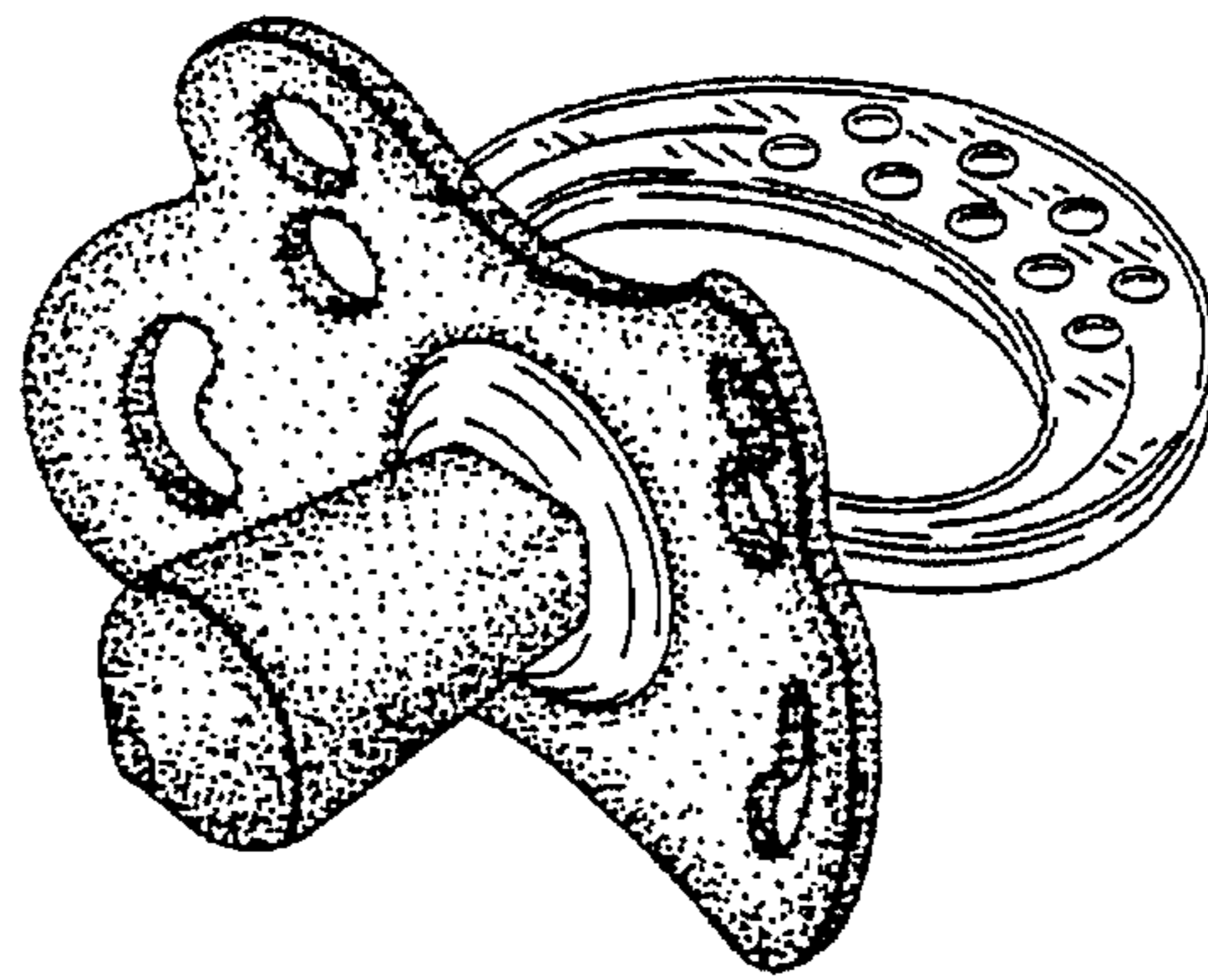

FIG. 7

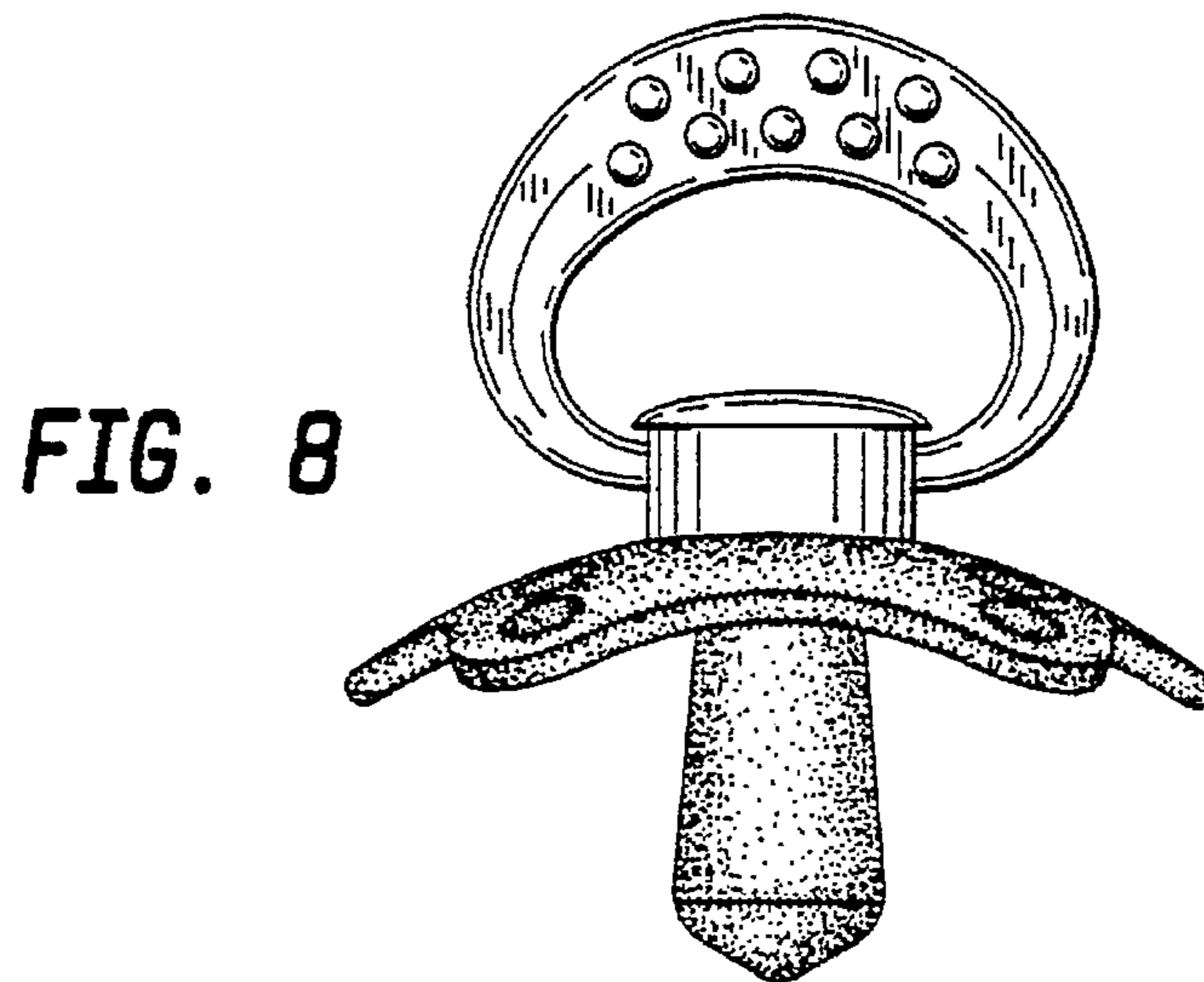

FIG. 8

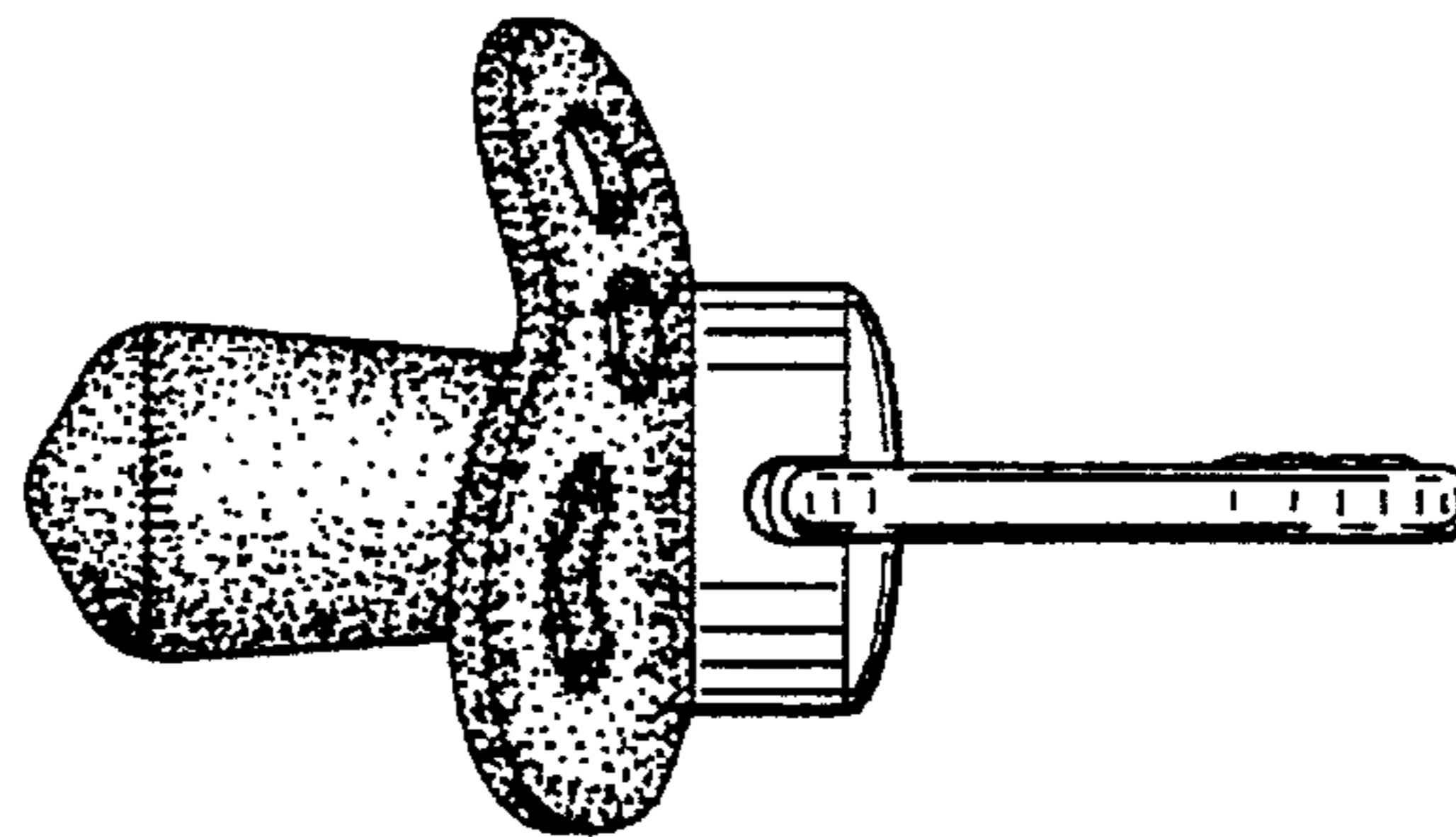

FIG. 9