



US00D380818S

United States Patent [19]
Yue

[11] **Patent Number:** **Des. 380,818**
[45] **Date of Patent:** ****Jul. 8, 1997**

[54] **RETRACTABLE CORD REEL DRYER**

[75] Inventor: **Brenda P. K. Yue**, Kowloon, Hong Kong
[73] Assignee: **Conair Corporation**, Stamford, Conn.
[**] Term: **14 Years**
[21] Appl. No.: **53,255**
[22] Filed: **Apr. 18, 1996**

[51] **LOC (6) Cl.** **23-03**
[52] **U.S. Cl.** **D23/335; D23/332; D28/13**
[58] **Field of Search** **D23/332, 370, D23/335, 336; D28/12-18; 392/384, 385**

[56] **References Cited**

U.S. PATENT DOCUMENTS

D. 286,209 10/1986 Camens D28/13
D. 293,020 12/1987 Steinel et al. D23/332
D. 360,282 7/1995 Anzuoni, Jr. et al. D28/15
4,802,287 2/1989 Chen 392/384

FOREIGN PATENT DOCUMENTS

79101 5/1983 European Pat. Off. 392/385

OTHER PUBLICATIONS

Home Furnishings Daily, Monday, Jul. 12, 1976, Son Of A Gun Dryer, top left side of page.
Merchandising, Jan. 1978, p. 124, Pocket Pistol blower/dryer middle right side of page.

Primary Examiner—Lisa Lichtenstein
Attorney, Agent, or Firm—Ohlandt, Greeley, Ruggiero & Perle

[57] **CLAIM**

The ornamental design for a retractable cord reel dryer, as shown and described.

DESCRIPTION

FIG. 1 is a top perspective view of a retractable cord reel dryer showing my new design;
FIG. 2 is a left side elevational view thereof;
FIG. 3 is a right side elevational view thereof;
FIG. 4 is a front elevational view thereof;
FIG. 5 is a rear elevational view thereof;
FIG. 6 is a top plan view thereof; and,
FIG. 7 is a bottom plan view thereof.

The pattern of circular apertures is shown partially in FIG. 5 for ease of illustration and is understood to extend uniformly throughout the area represented.

1 Claim, 3 Drawing Sheets

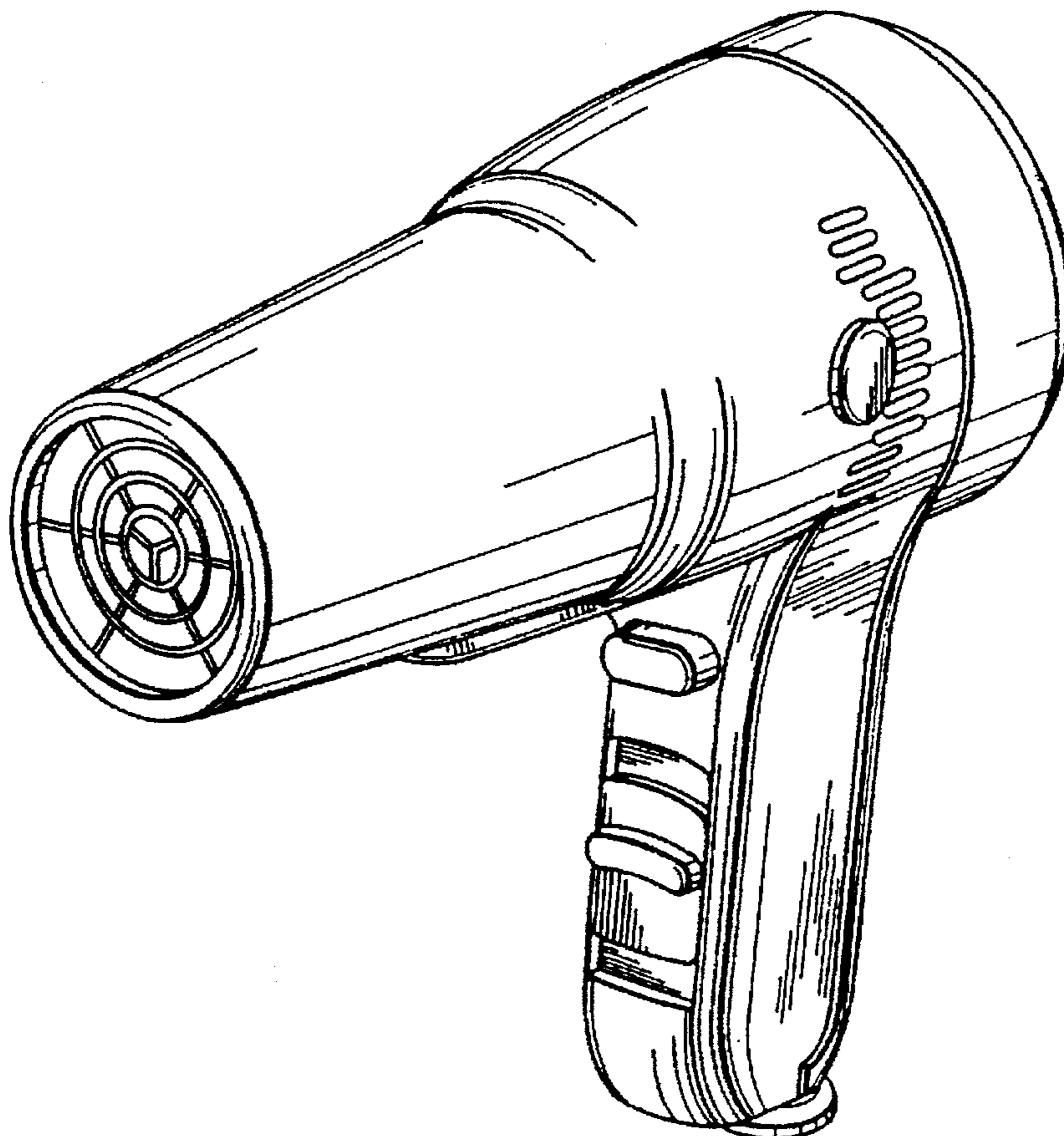

FIG. 1.

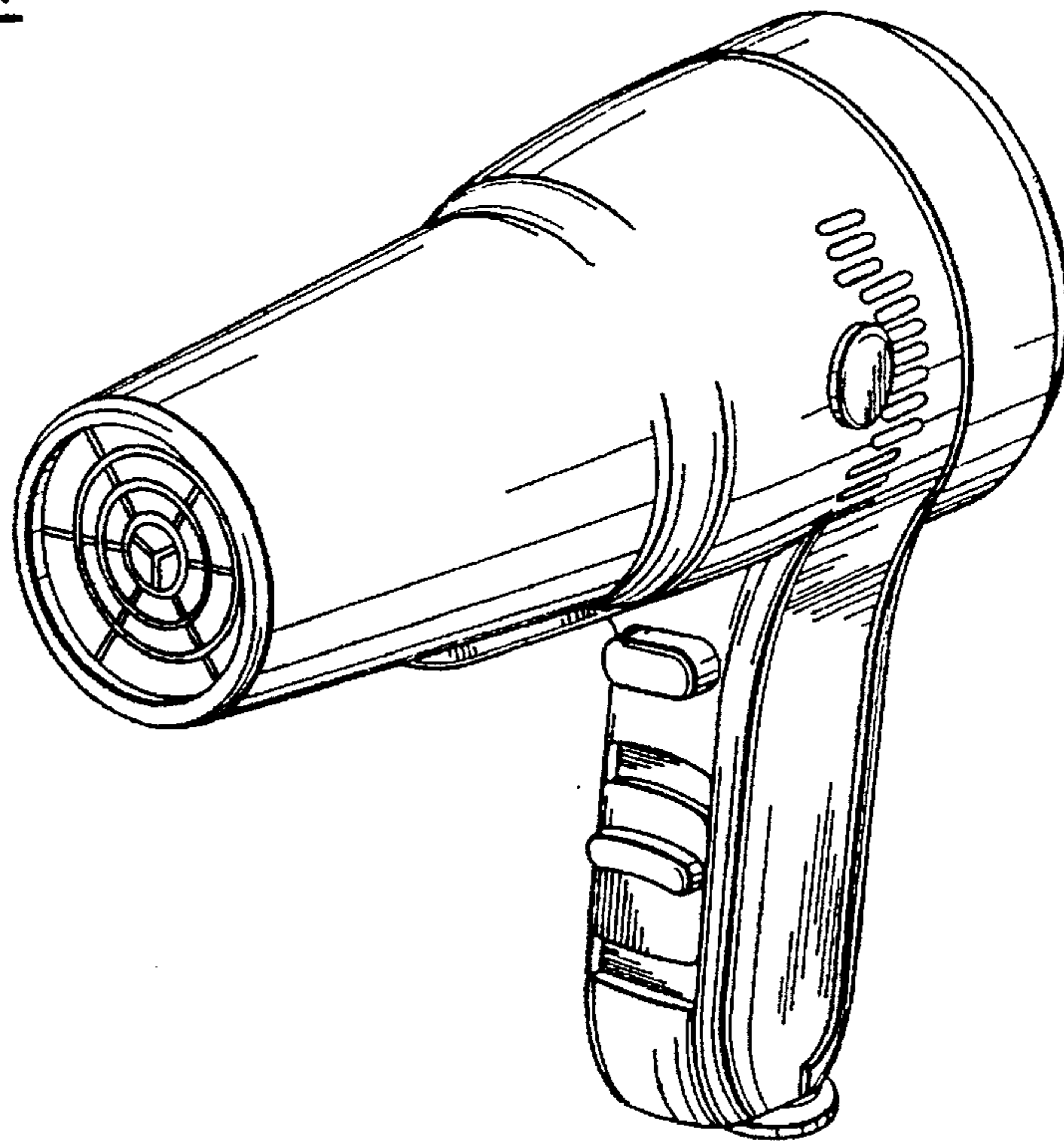

FIG. 2.

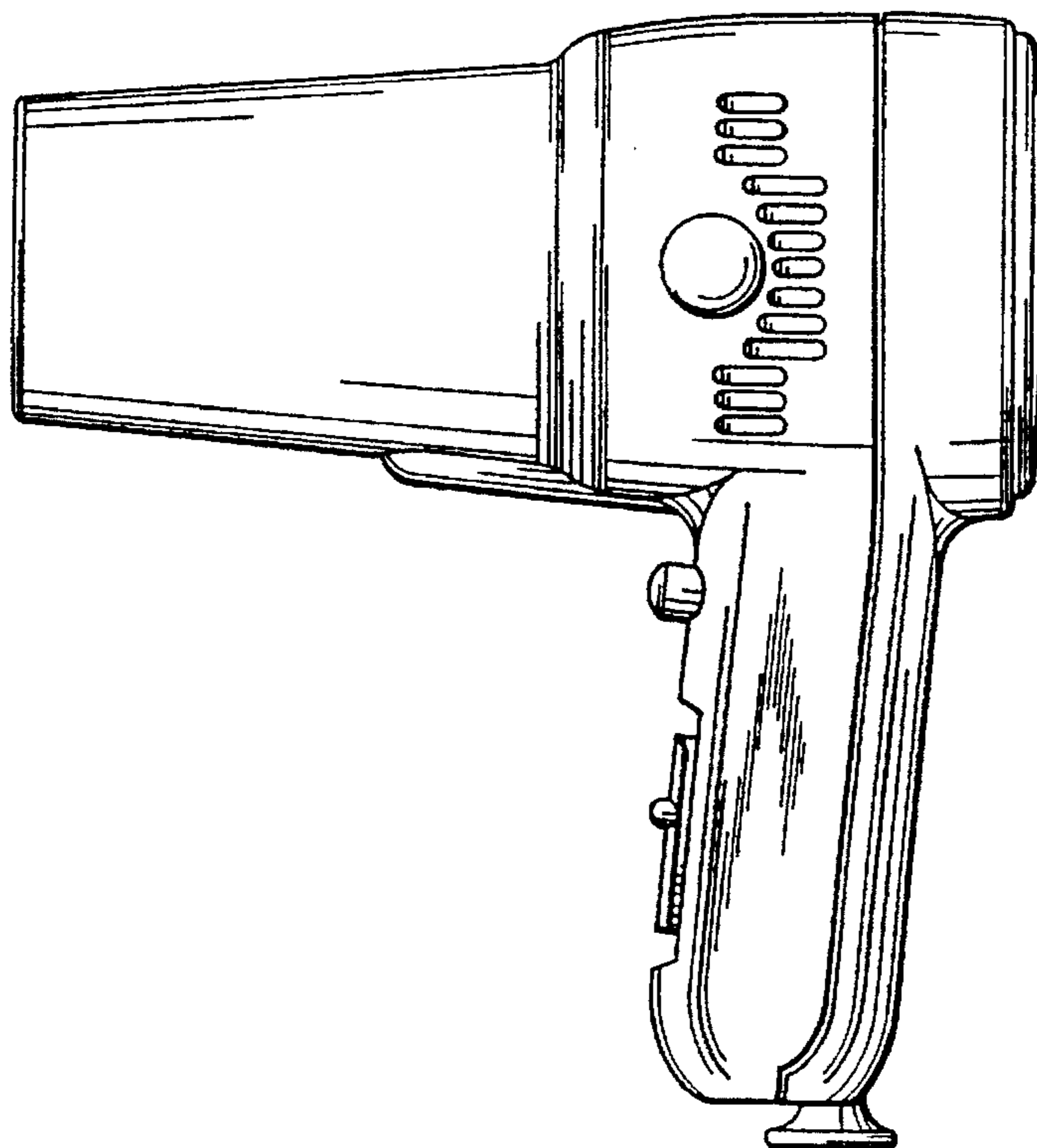

FIG. 3.

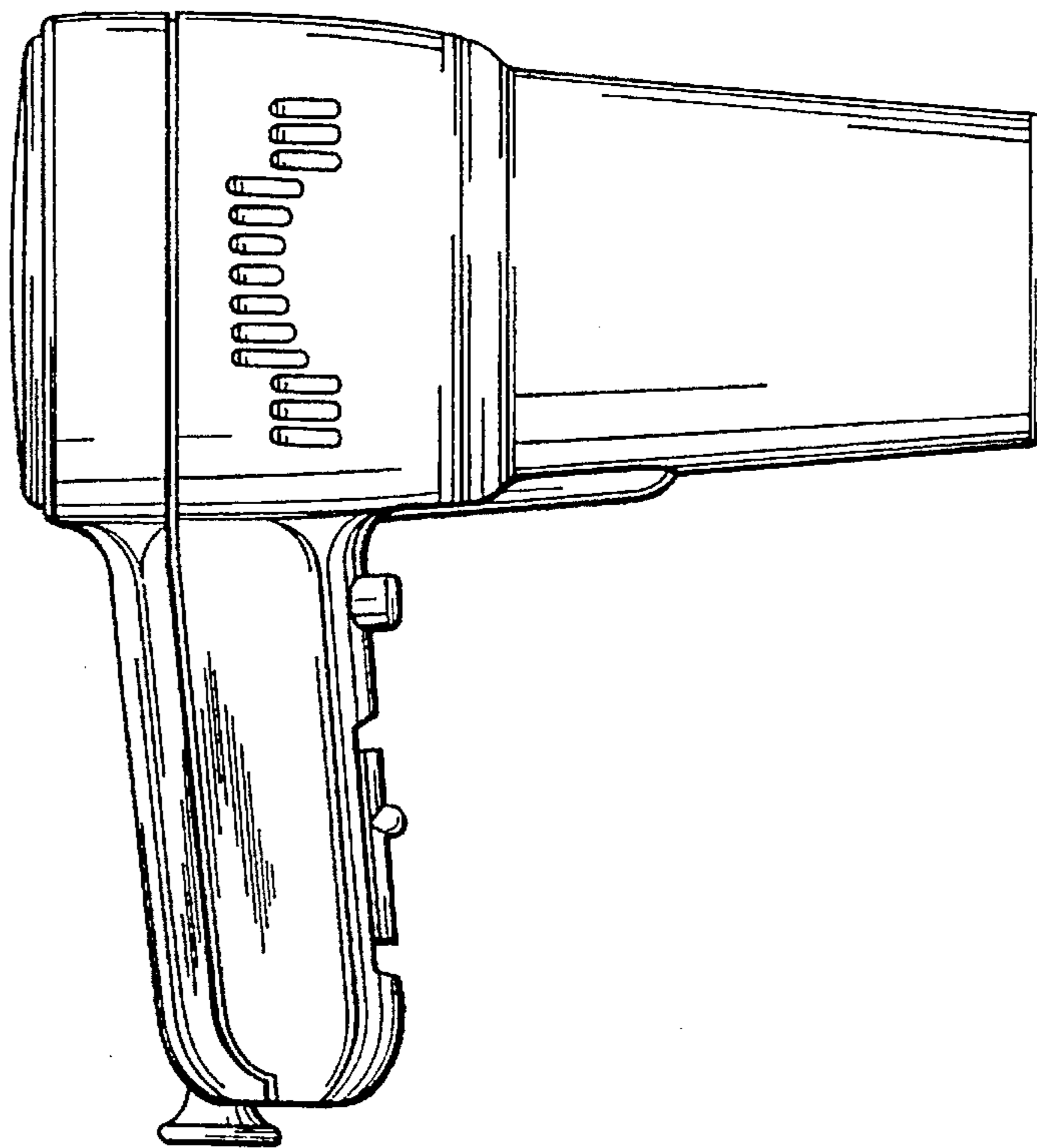

FIG. 4.

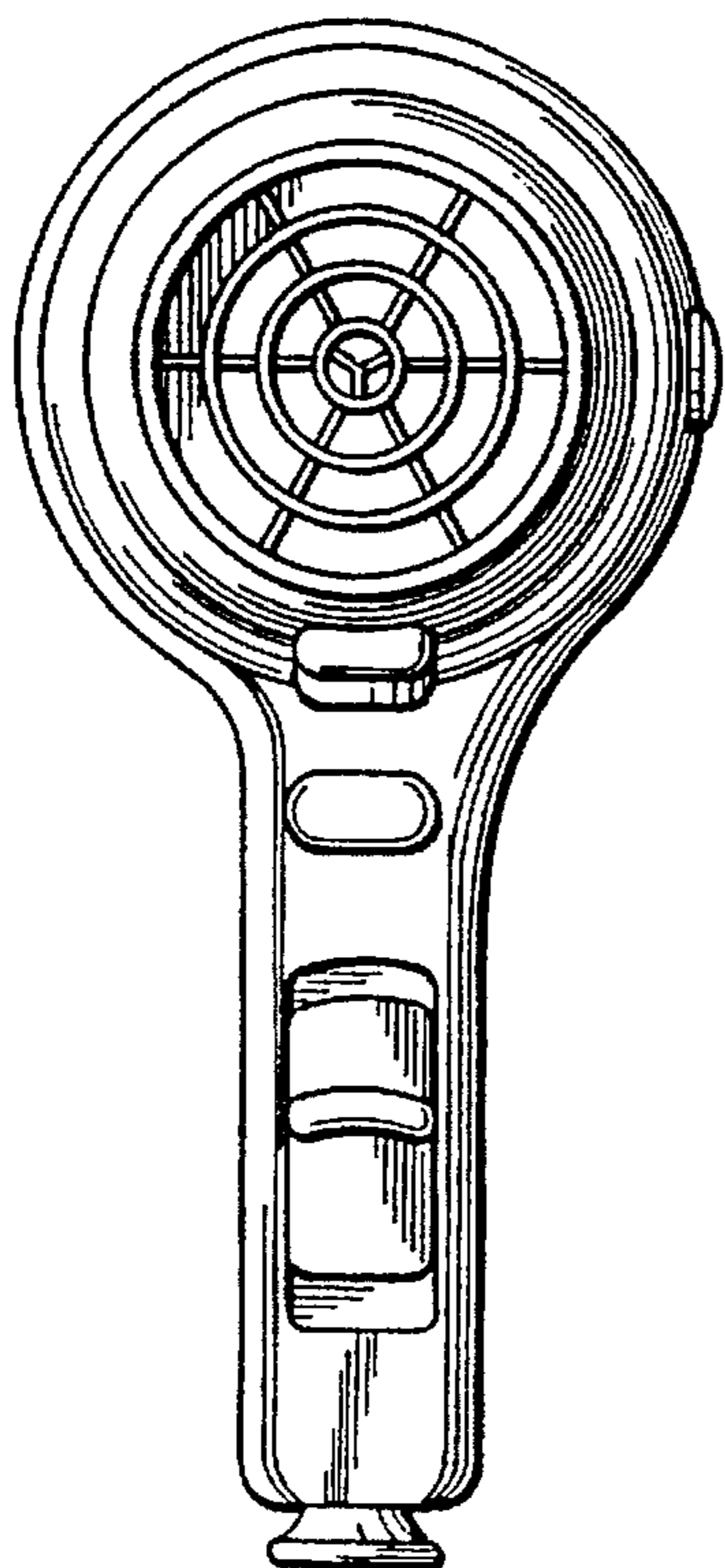

FIG. 5.

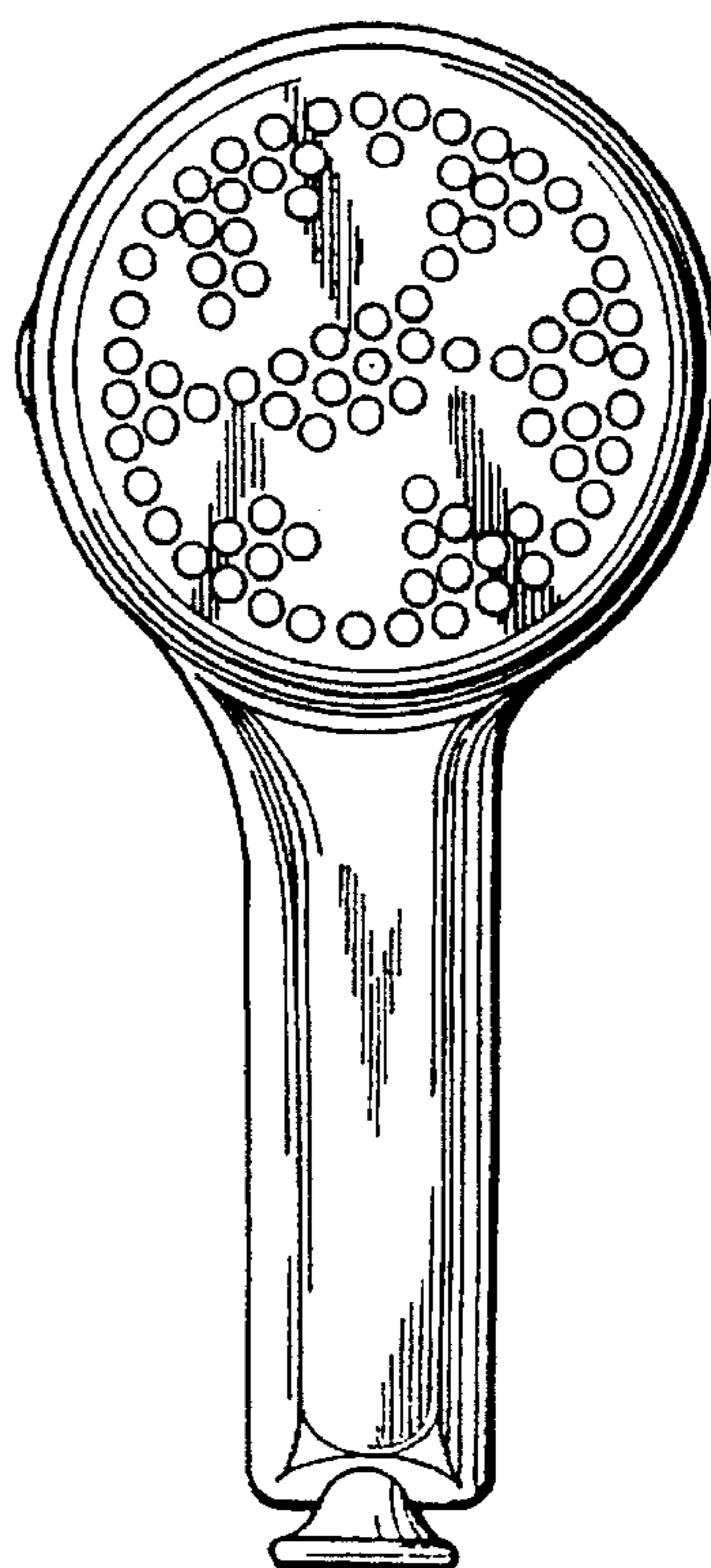

FIG. 6.

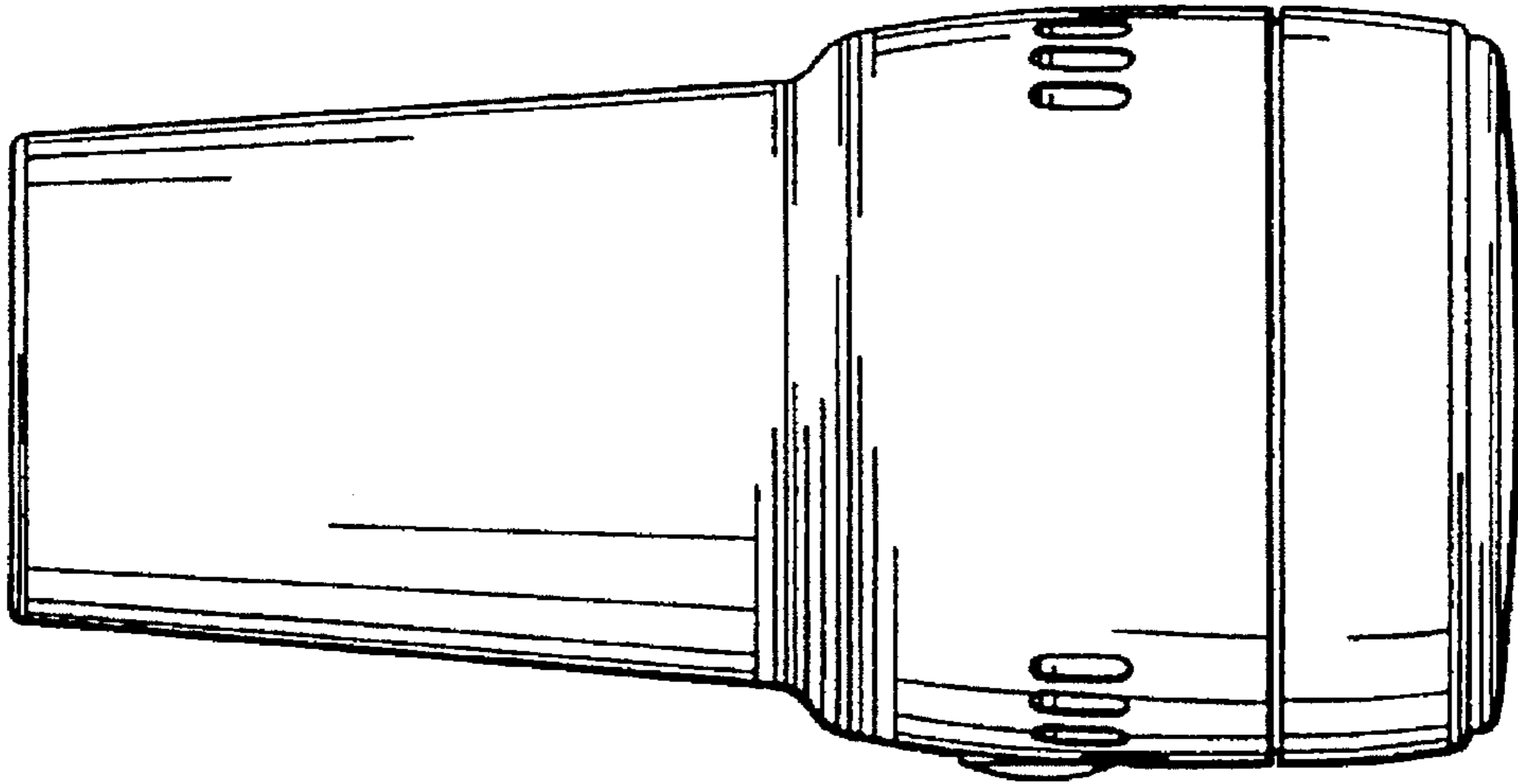

FIG. 7.

