



US00D380816S

United States Patent [19]
Westmoreland

[11] **Patent Number: Des. 380,816**
[45] **Date of Patent: **Jul. 8, 1997**

[54] **COMMODE CLEANING DEVICE**

5,031,252 7/1991 Oyama 4/222 X

[76] Inventor: **Dorothy P. Westmoreland**, 4799 U.S.
Hwy. 601-N, Mocksville, N.C.
27028-3656

Primary Examiner—Stella Reid
Assistant Examiner—Eric Watterson
Attorney, Agent, or Firm—Dennis H. Lambert

[**] Term: **14 Years**

[57] **CLAIM**

[21] Appl. No.: **47,642**

The ornamental design for a commode cleaning device, as shown and described.

[22] Filed: **Dec. 8, 1995**

DESCRIPTION

[51] **LOC (6) Cl.** **23-02**

[52] **U.S. Cl.** **D23/309**

[58] **Field of Search** D23/303, 311;
4/222, 233, 223, 224, 231, 420.4

FIG. 1 is a front, top and side perspective view of the commode cleaning device embodying the design of the present invention;

FIG. 2 is a front elevational view thereof;

FIG. 3 is a rear elevational view thereof;

FIG. 4 is a side elevational view thereof, the opposite being a mirror image of the side shown in FIG. 4;

FIG. 5 is a top plan view thereof;

FIG. 6 is a bottom plan view thereof; and,

FIG. 7 is a side elevational view thereof, showing a toilet in broken lines for illustrative purposes only and forming no part of the claimed design.

[56] **References Cited**

U.S. PATENT DOCUMENTS

1,070,108	8/1913	Brittian .	
1,145,669	7/1915	Brown .	
3,336,603	8/1967	Leland	4/223
4,096,593	6/1978	Vlahakis .	
4,183,105	1/1980	Womack	4/223 X
4,873,729	10/1989	Micallef	4/223 X

1 Claim, 4 Drawing Sheets

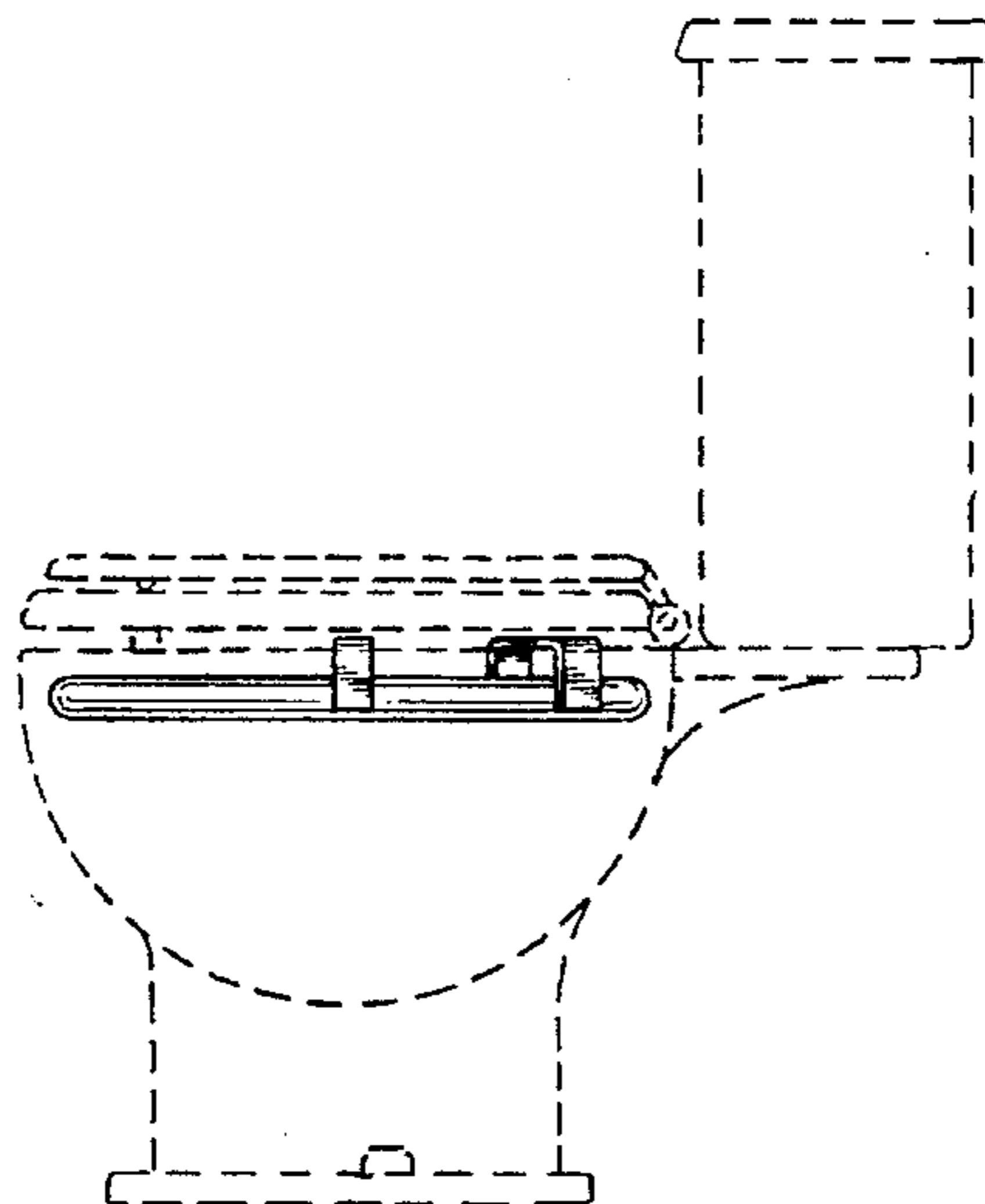
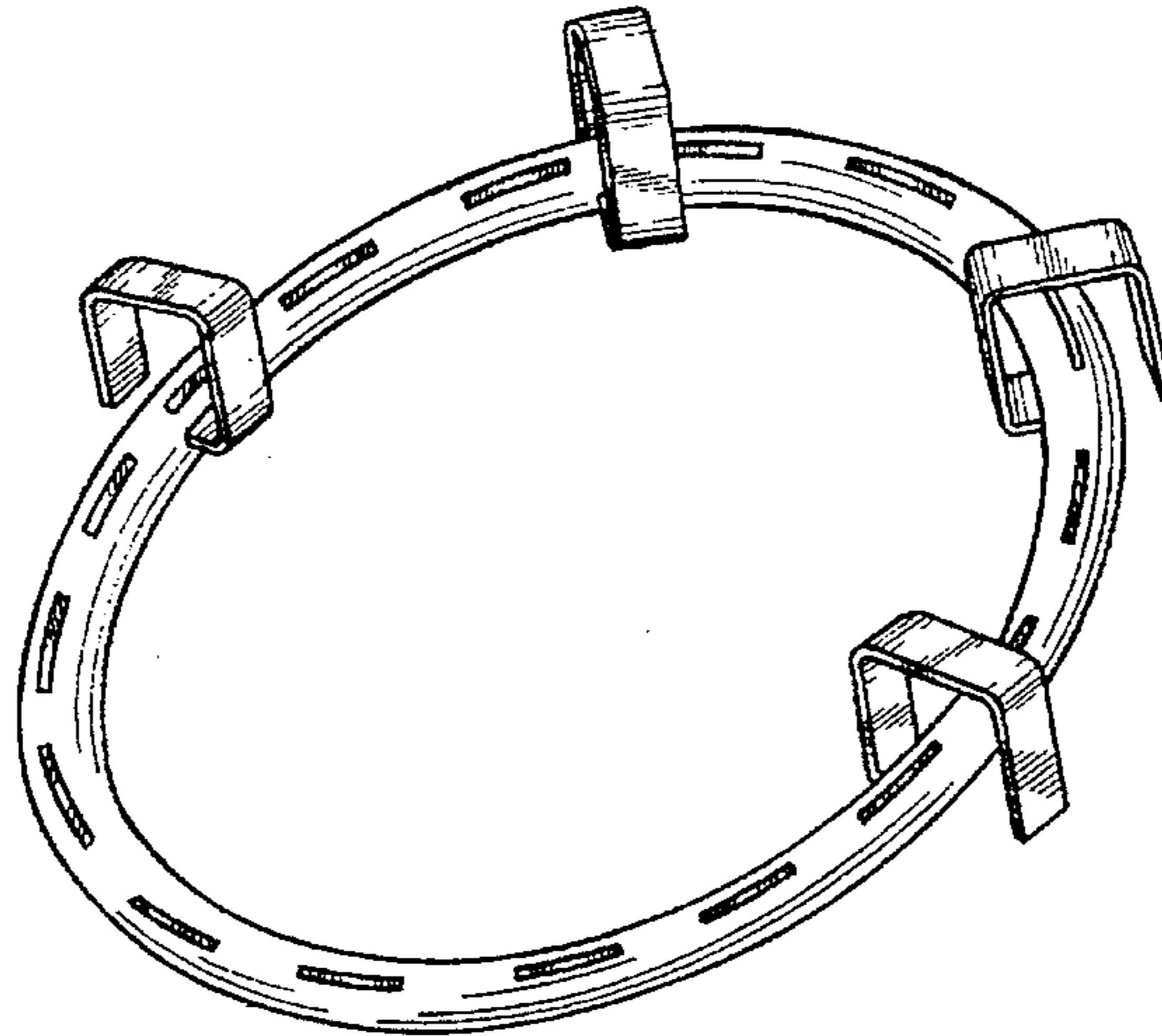

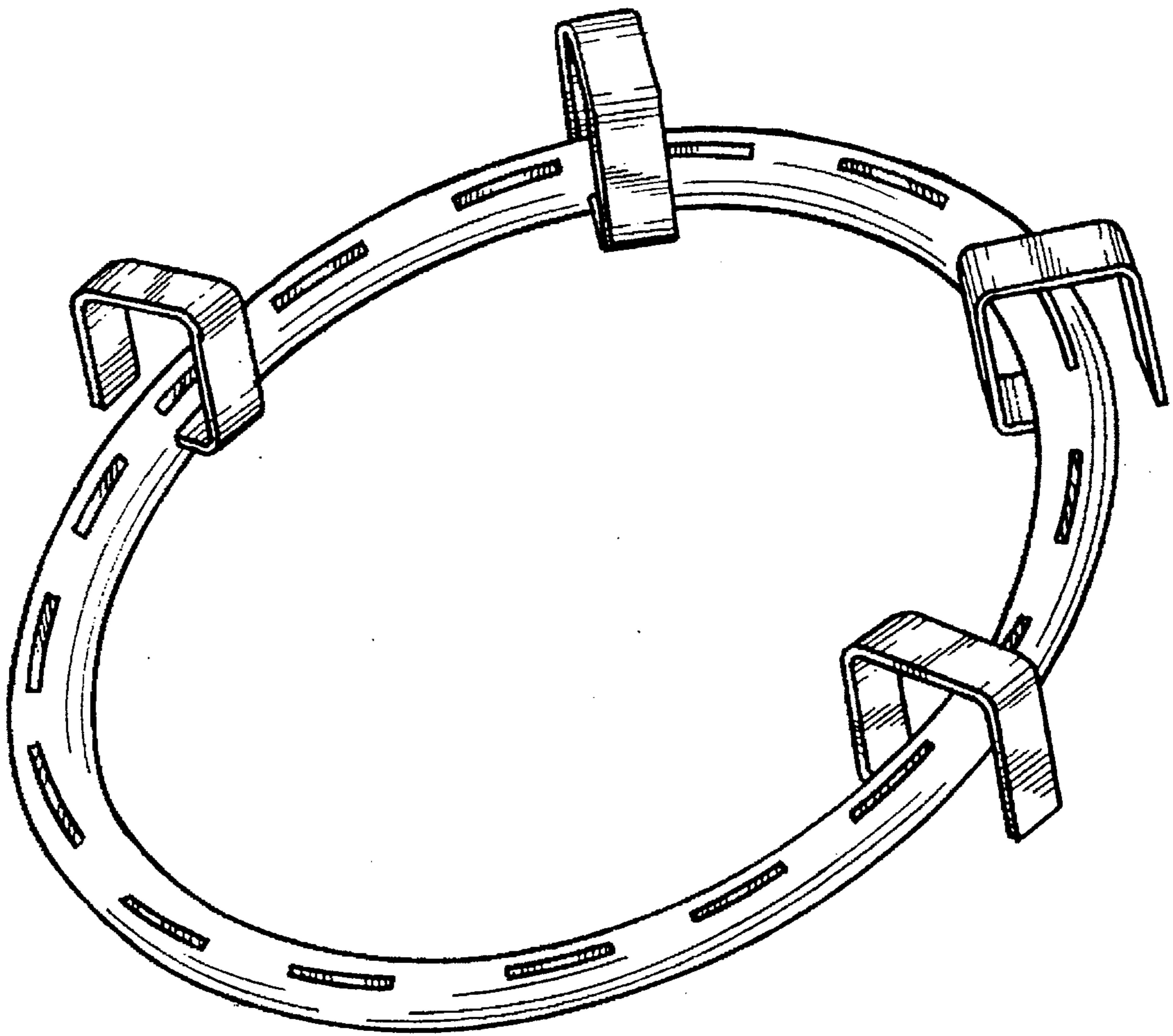

FIG. 1.

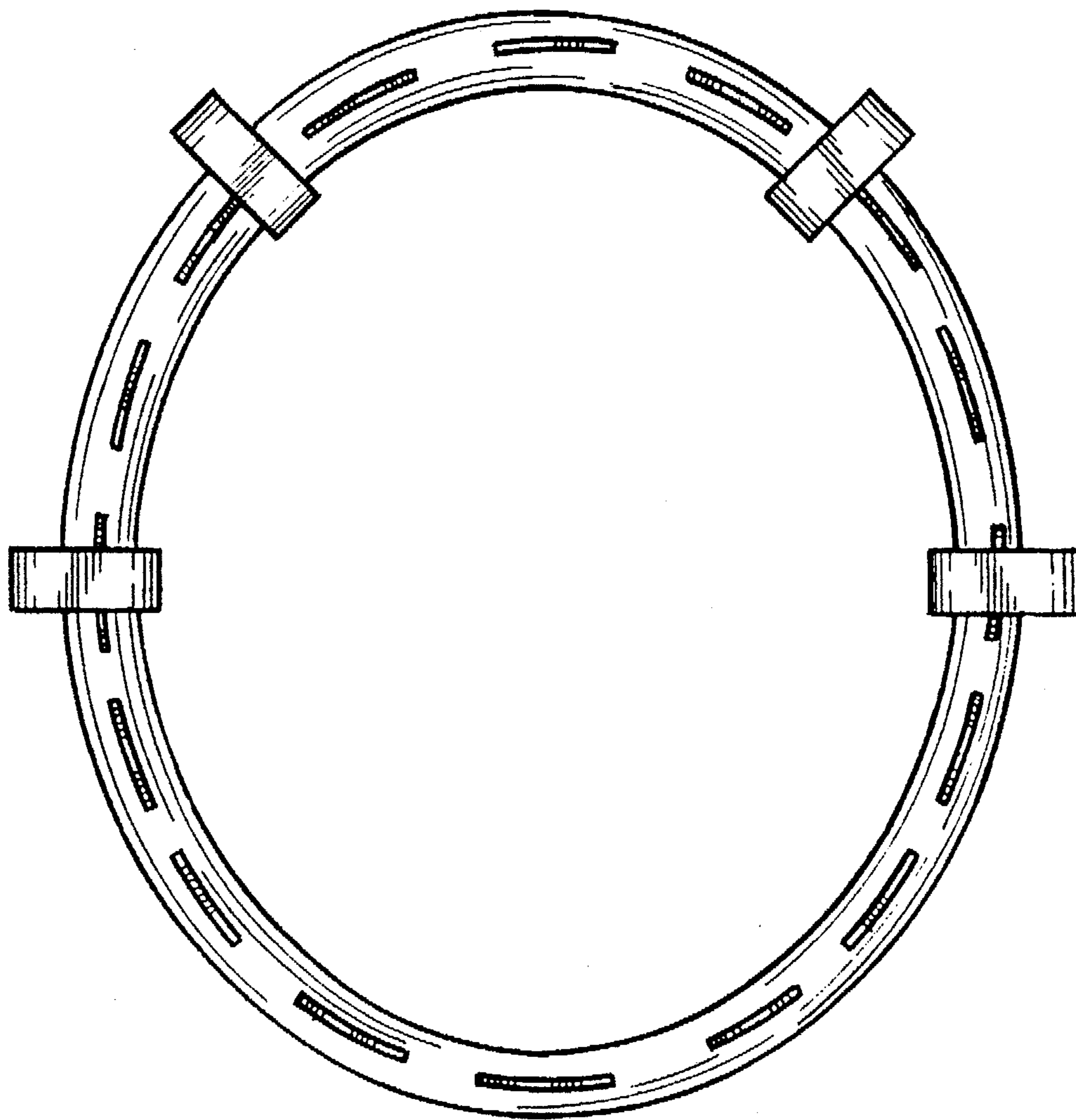

FIG. 5.

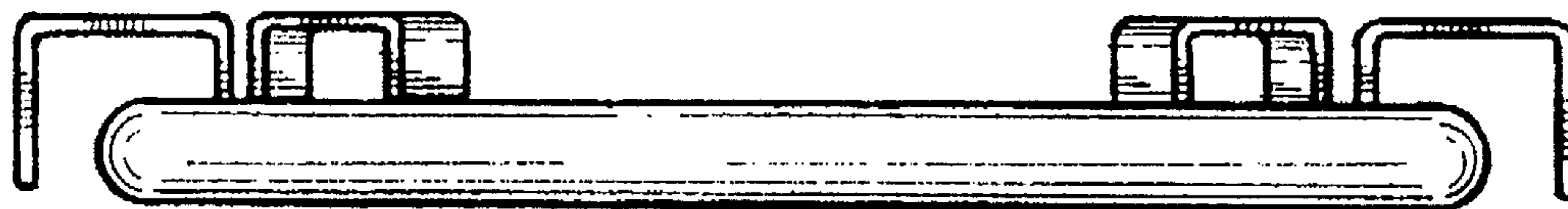

FIG. 2.

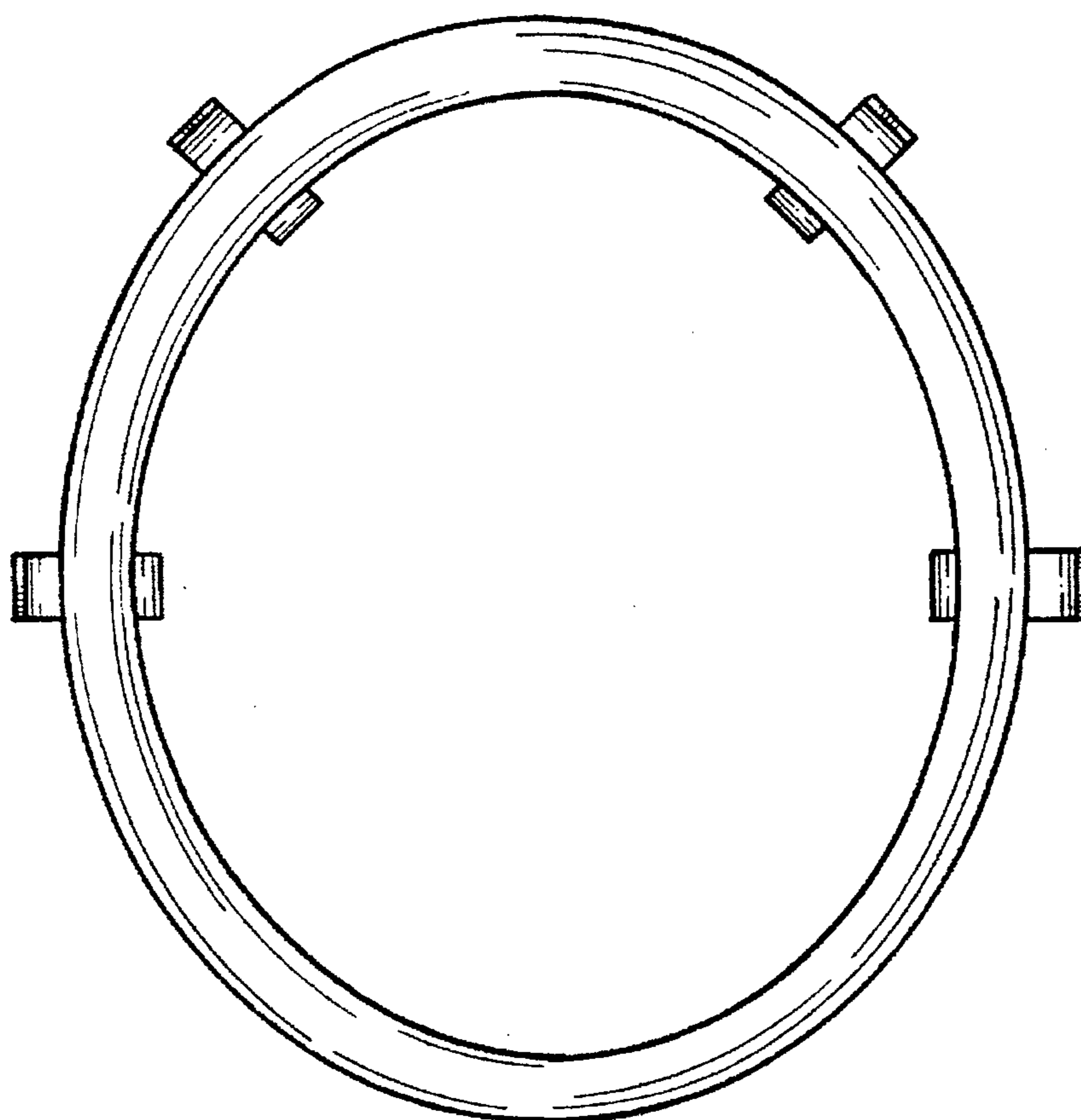

FIG. 6.

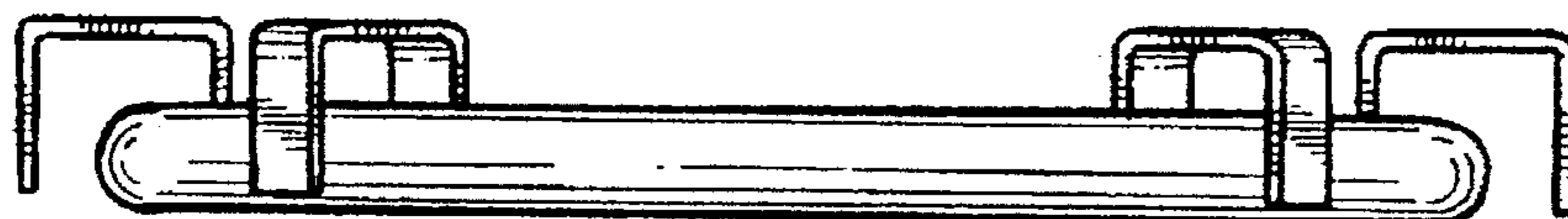

FIG. 3.

FIG. 4.



FIG. 7.

