



US00D380768S

United States Patent [19] Agata

[11] Patent Number: **Des. 380,768**
[45] Date of Patent: ****Jul. 8, 1997**

[54] **PHOTOCOPIER**

[75] Inventor: **Nobuyuki Agata, Soka, Japan**

[73] Assignee: **Canon Kabushiki Kaisha, Tokyo, Japan**

[**] Term: **14 Years**

[21] Appl. No.: **52,218**

[22] Filed: **Mar. 26, 1996**

[30] **Foreign Application Priority Data**

Sep. 27, 1995 [JP] Japan 7-28871

[51] LOC (6) Cl. **16-03**

[52] U.S. Cl. **D18/38**

[58] Field of Search D18/36-39; D14/111,
D14/112, 116, 118; 355/200, 210, 231,
233-236, 245, 326-328

[56] **References Cited**

U.S. PATENT DOCUMENTS

D. 280,629 9/1985 Goto et al. D18/38

D. 320,409 10/1991 Kosako et al. D18/39
D. 334,943 4/1993 Suzuki et al. D18/39
D. 362,457 9/1995 Shimizu D18/39

Primary Examiner—James Gandy
Assistant Examiner—Caron D. Veynar
Attorney, Agent, or Firm—Fitzpatrick, Cella, Harper & Scinto

[57] **CLAIM**

The ornamental design for a photocopier, as shown and described.

DESCRIPTION

FIG. 1 is a front view of a photocopier showing my new design;
FIG. 2 is a rear view thereof;
FIG. 3 is a top plan view thereof;
FIG. 4 is a bottom plan view thereof;
FIG. 5 is a left side view thereof;
FIG. 6 is a right side view thereof; and,
FIG. 7 is a perspective view thereof.

1 Claim, 4 Drawing Sheets

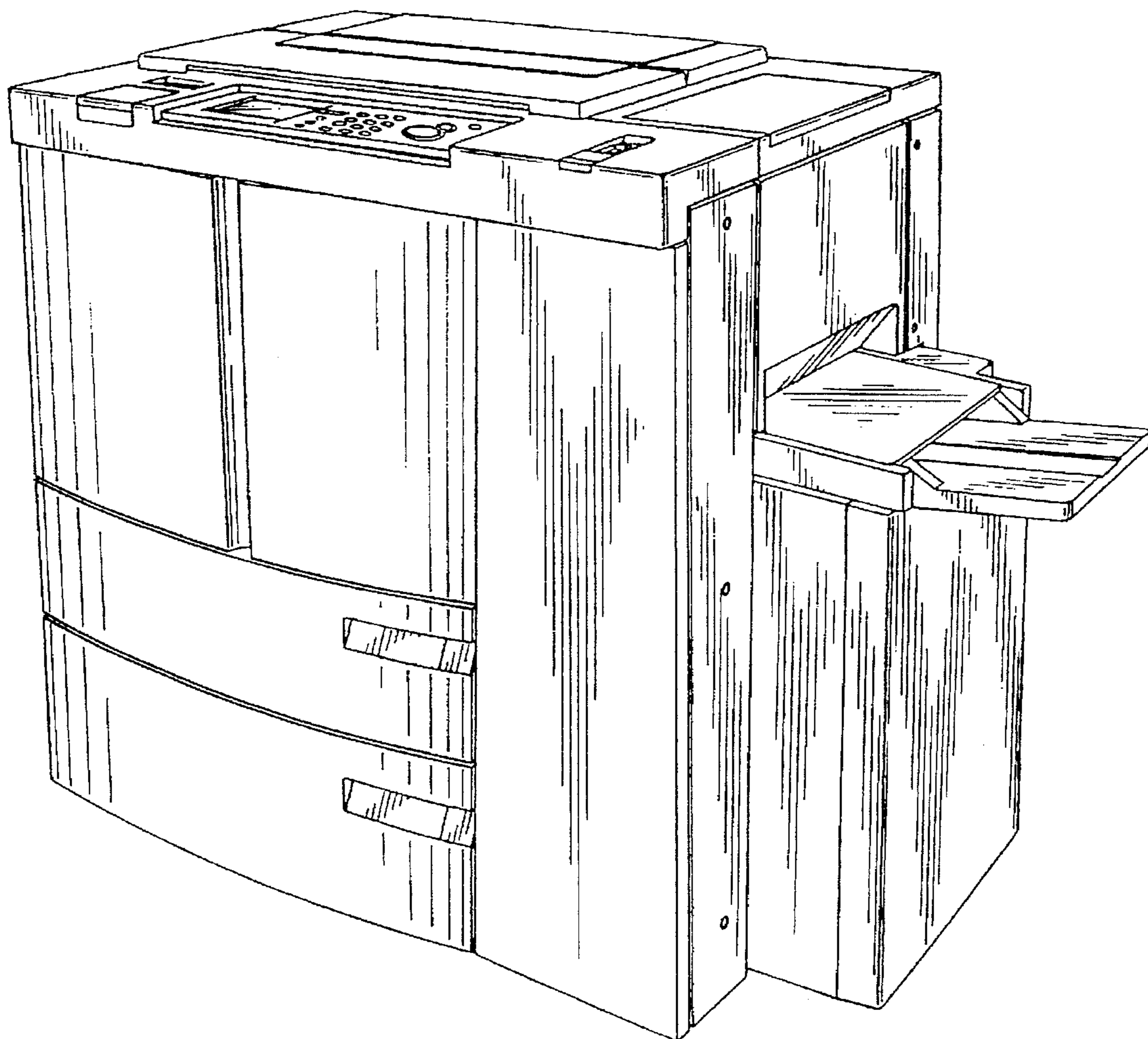

FIG. 1

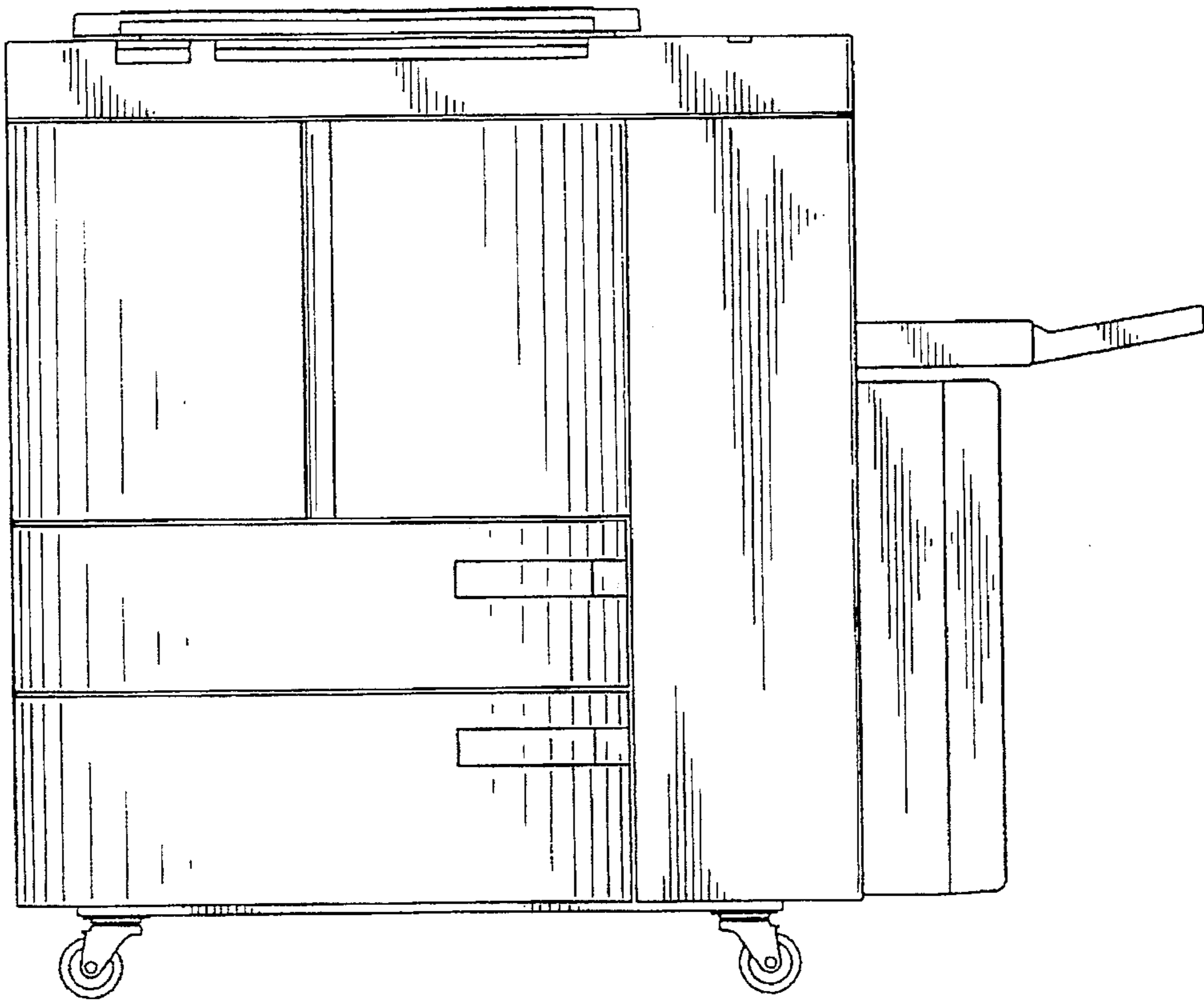

FIG. 2

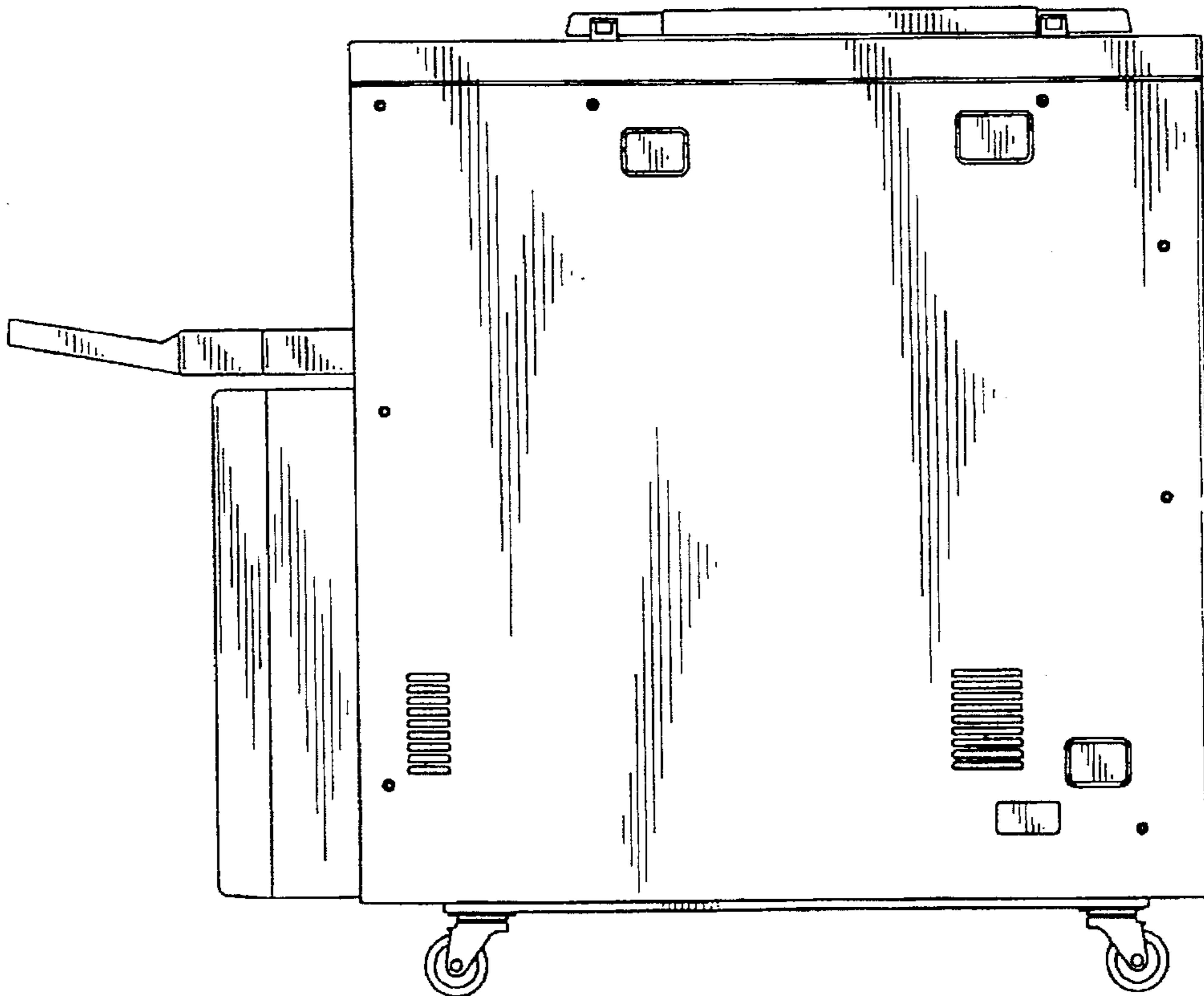

FIG. 3

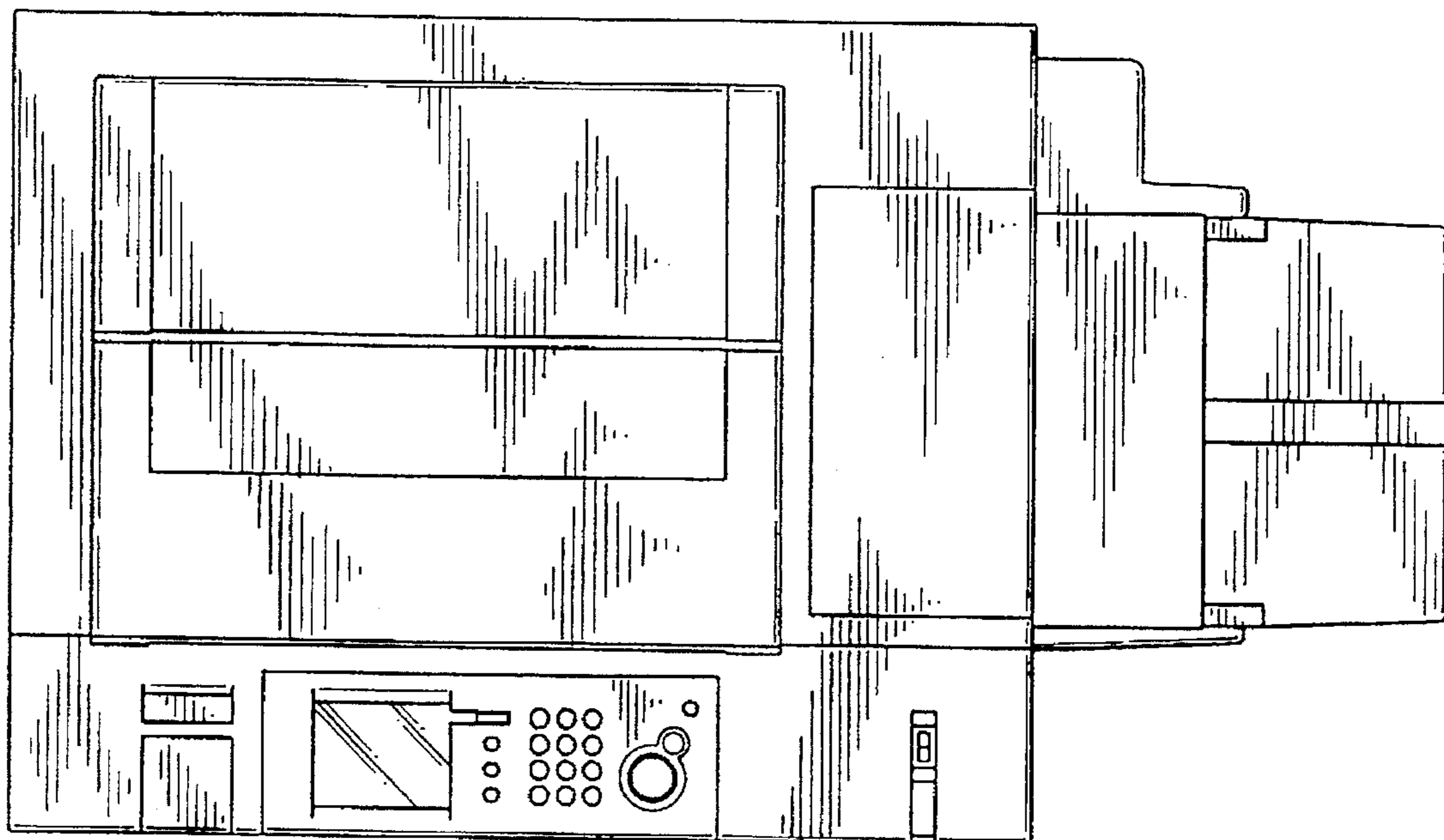

FIG. 4

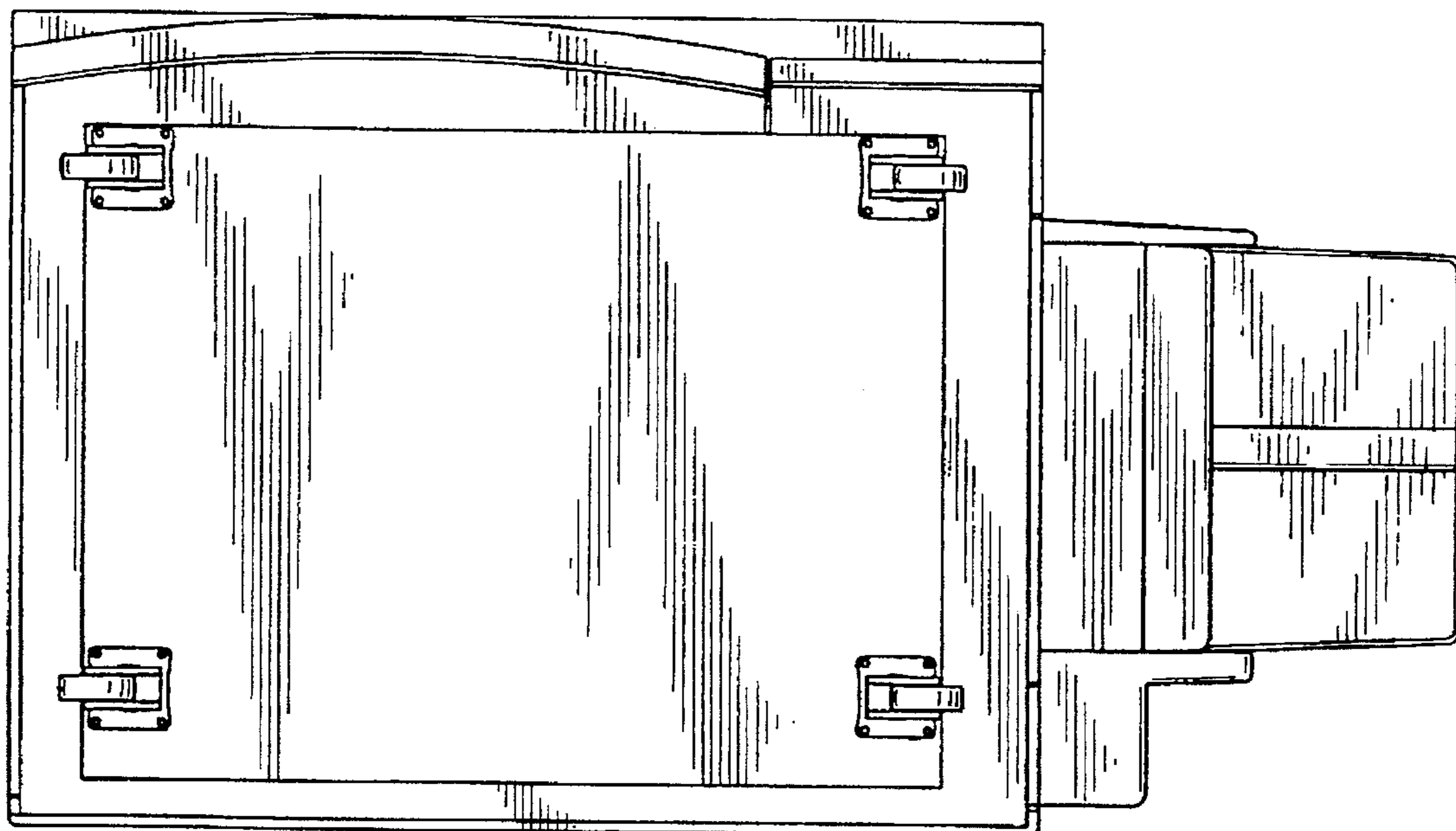

FIG. 5

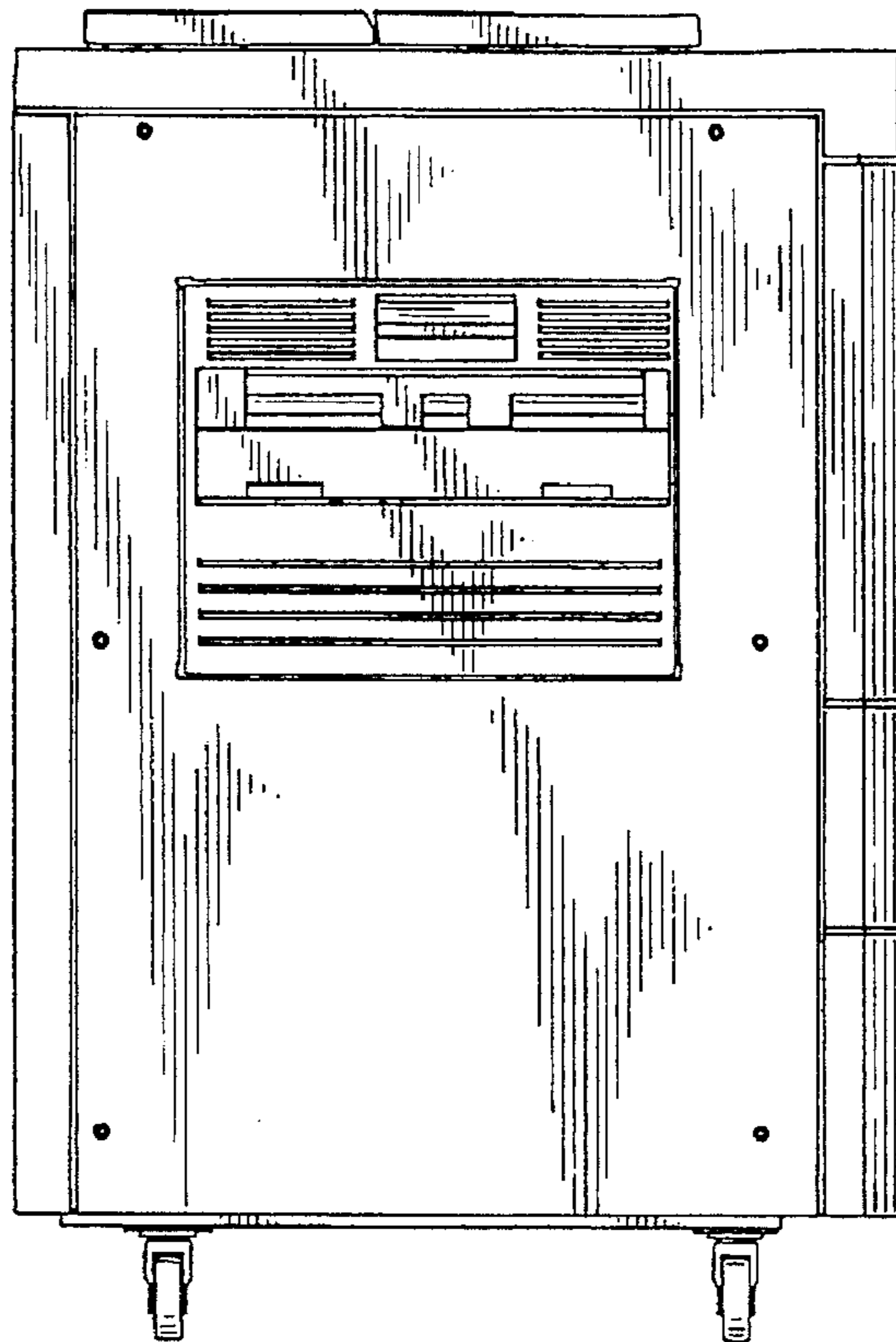

FIG. 6

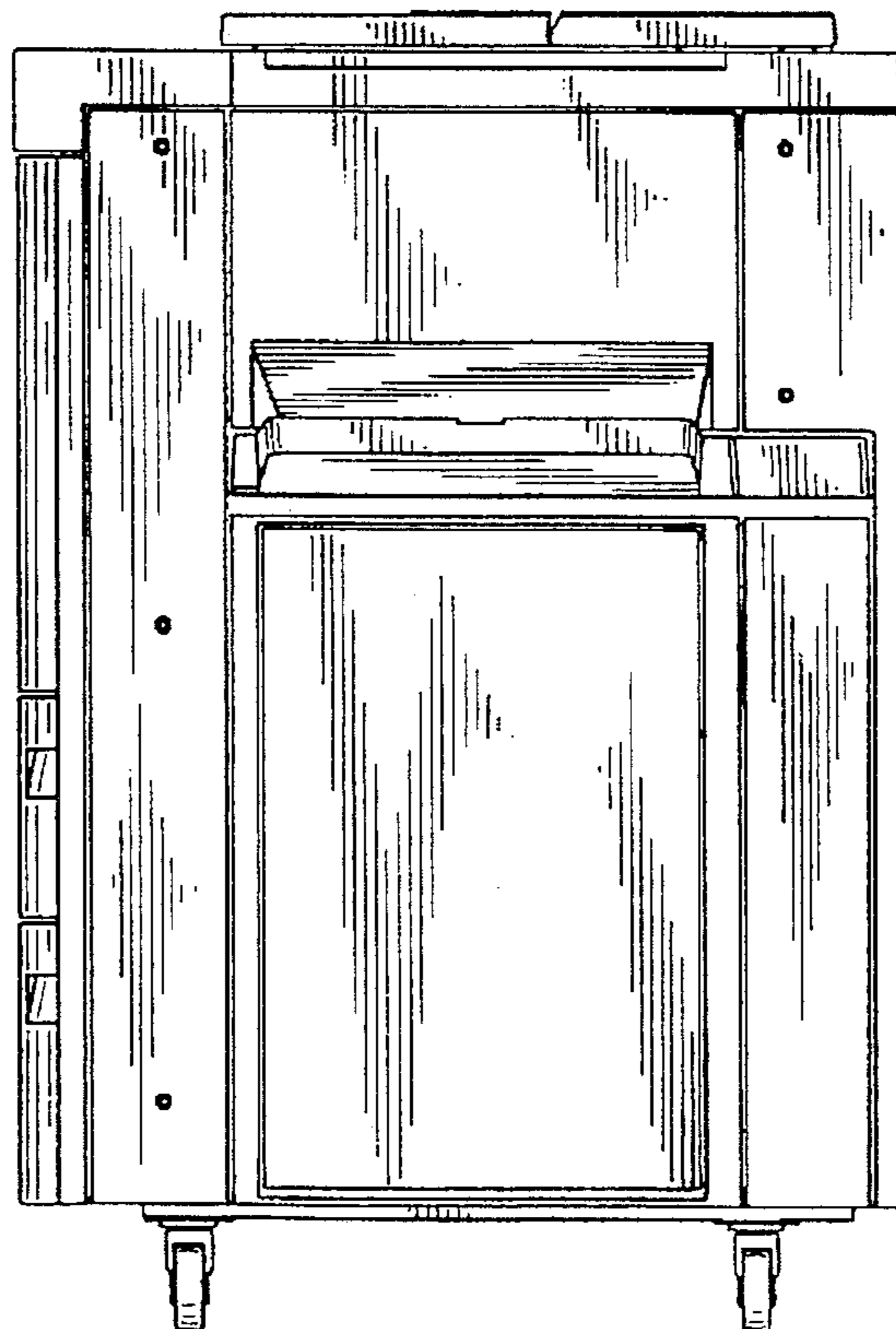

FIG. 7

