



US00D380680S

# United States Patent [19] Sun

[11] Patent Number: **Des. 380,680**

[45] Date of Patent: **\*\*Jul. 8, 1997**

[54] **PROTECTIVE DEVICE FOR PACKED GOODS**

92-2069 3/1992 Rep. of Korea .  
92-6355 9/1992 Rep. of Korea .  
17024/1992 10/1992 Rep. of Korea .

[76] Inventor: **Moon-Soo Sun**, 110-904, Lucky Apartment, Yeoksam-dong, Kangnam-ku, Seoul, Rep. of Korea

*Primary Examiner*—B. J. Bullock  
*Assistant Examiner*—Robert M. Spear  
*Attorney, Agent, or Firm*—Ratner & Prestia

[\*\*] Term: **14 Years**

[57] **CLAIM**

[21] Appl. No.: **32,780**

The ornamental design for a protective device for packed goods, as shown and described.

[22] Filed: **Dec. 28, 1994**

**DESCRIPTION**

[51] LOC (6) Cl. .... **09-99**

[52] U.S. Cl. .... **D9/456**

[58] **Field of Search** ..... D9/424, 425, 427, D9/430, 433, 434, 456, 499; D8/313; 206/147, 292; 220/630, 632, 638, 732, 737

FIG. 1 is a perspective view of a protective device for packed goods showing our new design;  
FIG. 2 is a front elevational view thereof;  
FIG. 3 is a rear elevational view thereof;  
FIG. 4 is a left elevational view thereof (the right elevational view being a mirror image thereof);  
FIG. 5 is a top plan view thereof;  
FIG. 6 is a bottom plan view thereof; and,  
FIG. 7 is a perspective view thereof of a protective device for packed goods showing our new design in use on packed goods.

[56] **References Cited**

**U.S. PATENT DOCUMENTS**

D. 10,435	2/1878	Luchs	.....	D9/430
D. 138,413	8/1944	Powers	.....	D9/430
D. 225,206	11/1972	Heggen	.....	D8/313
D. 338,620	8/1993	Brozowski	.....	D9/430
5,295,598	3/1994	Gerlach et al.	.....	220/630

**FOREIGN PATENT DOCUMENTS**

92-2068 3/1992 Rep. of Korea .

The broken lines showing packed goods are for illustrative purposes only and form no part of the claimed design.

**1 Claim, 4 Drawing Sheets**

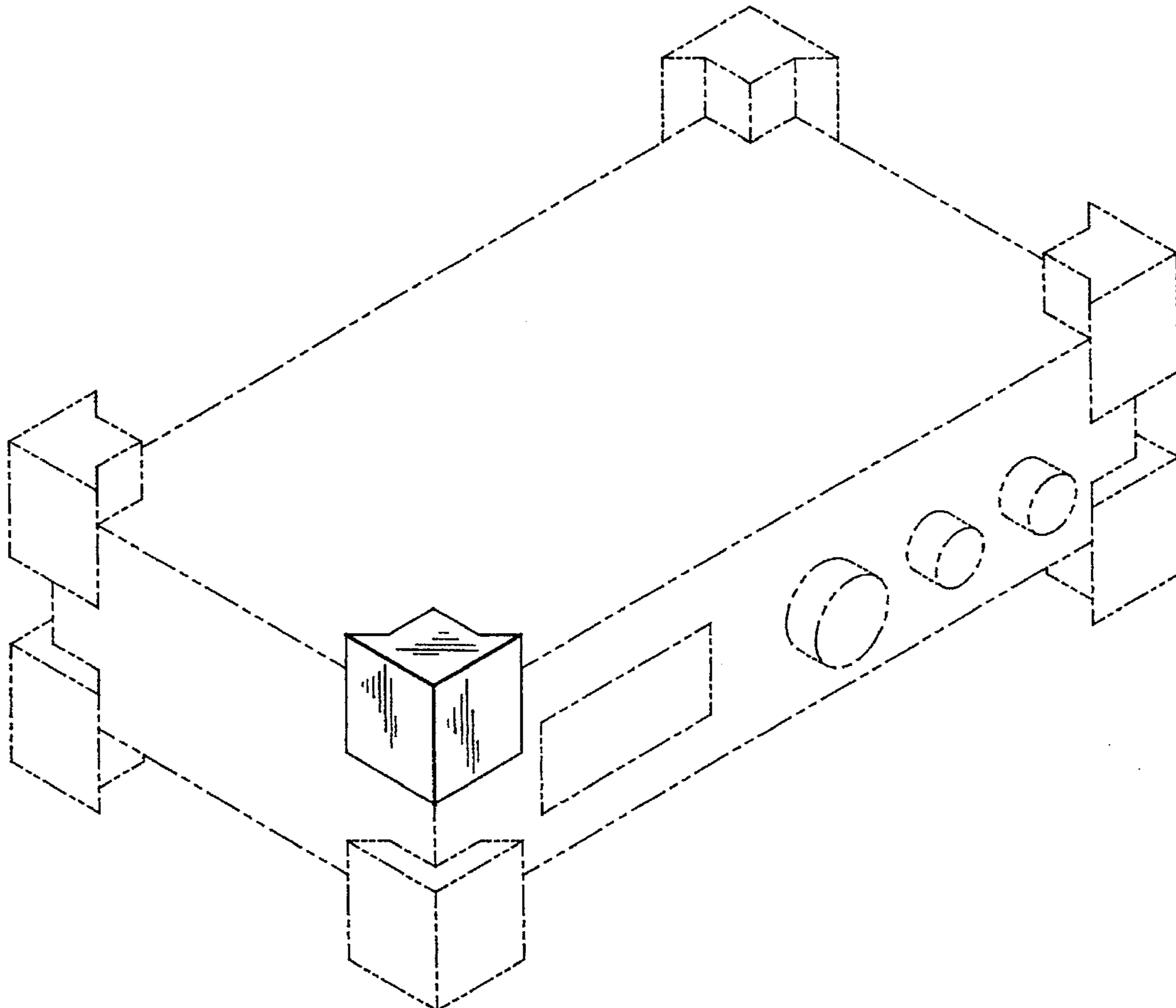

Fig 1

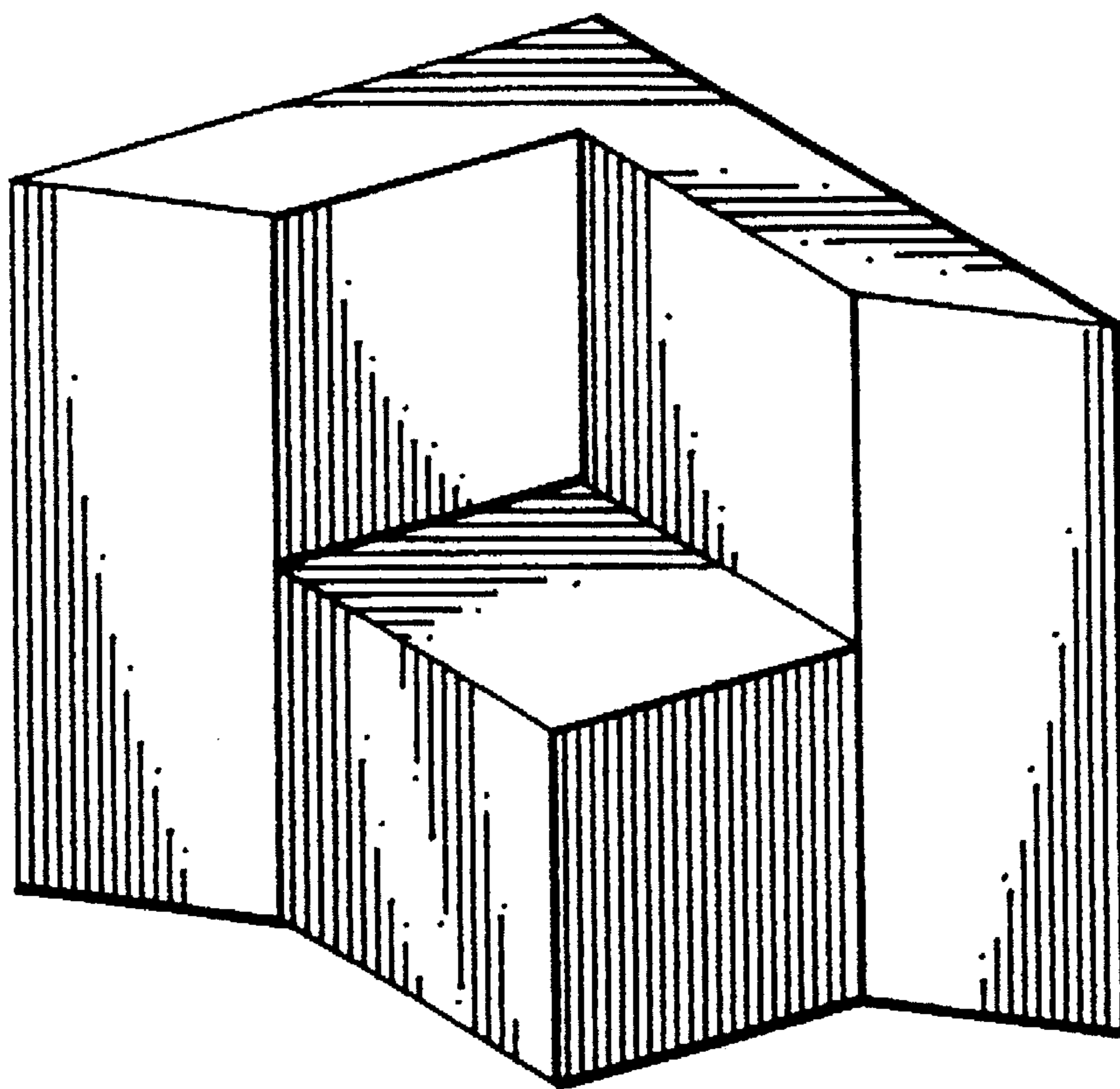

Fig 2

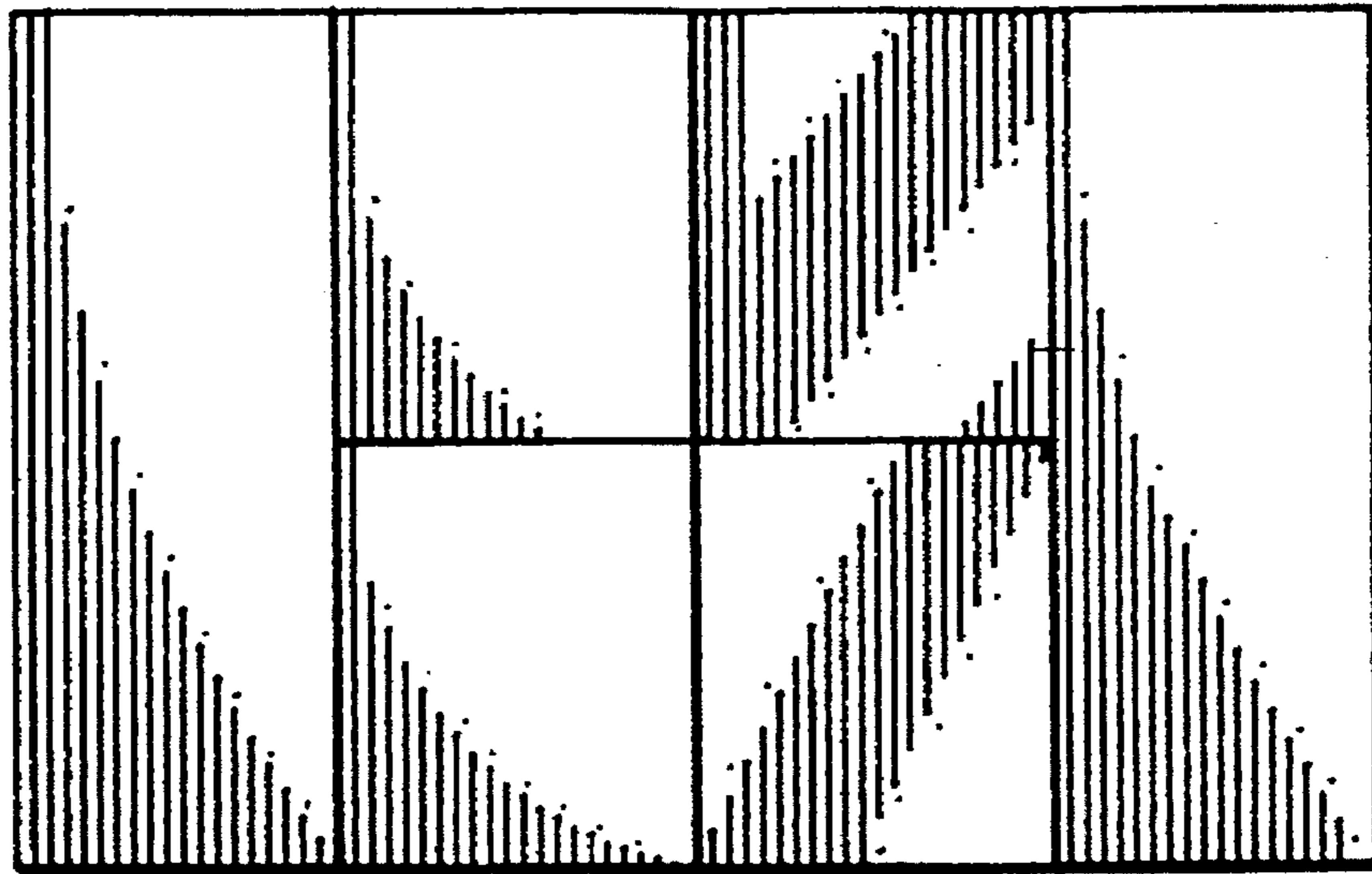

Fig 3

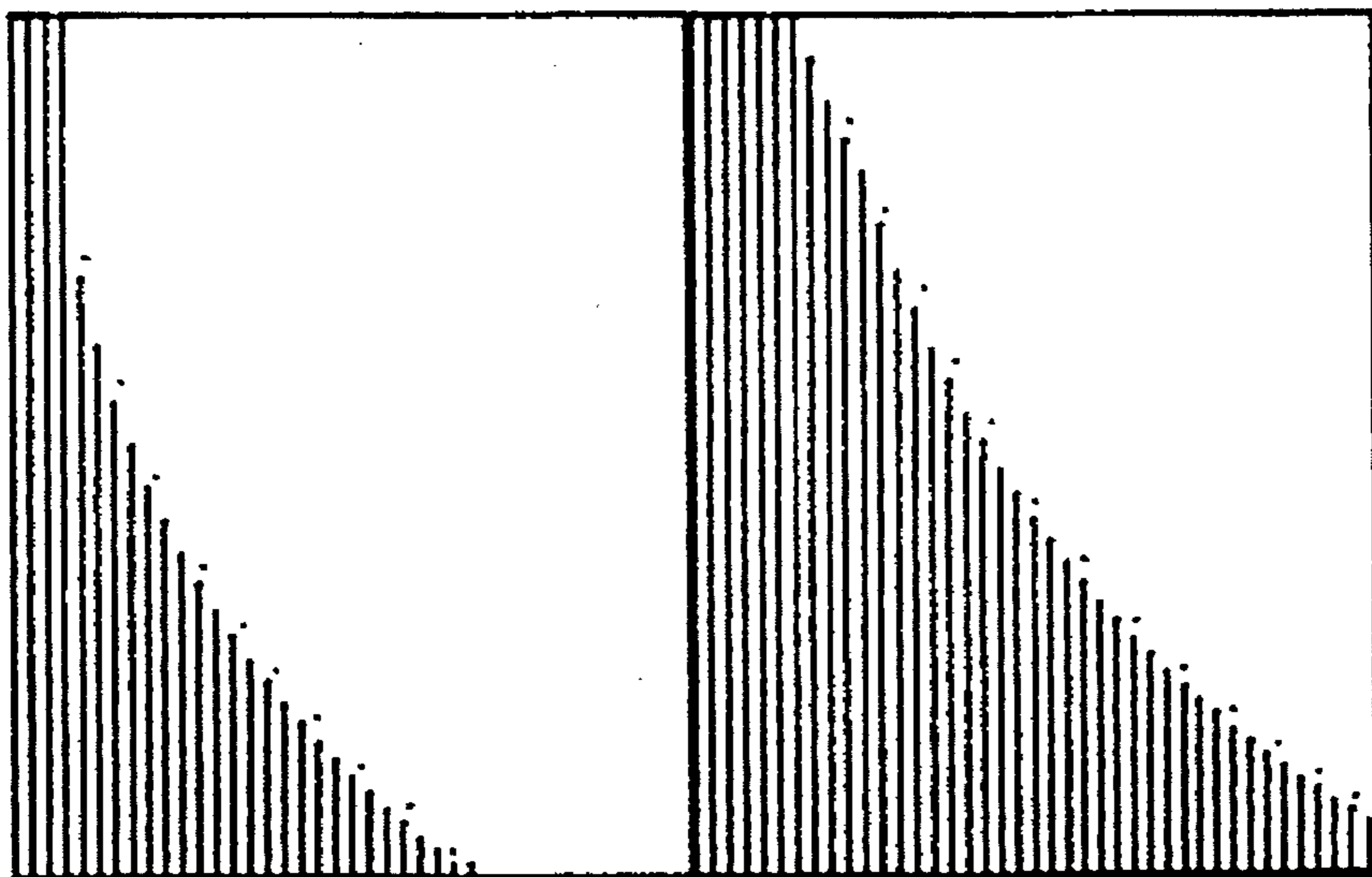

Fig 4

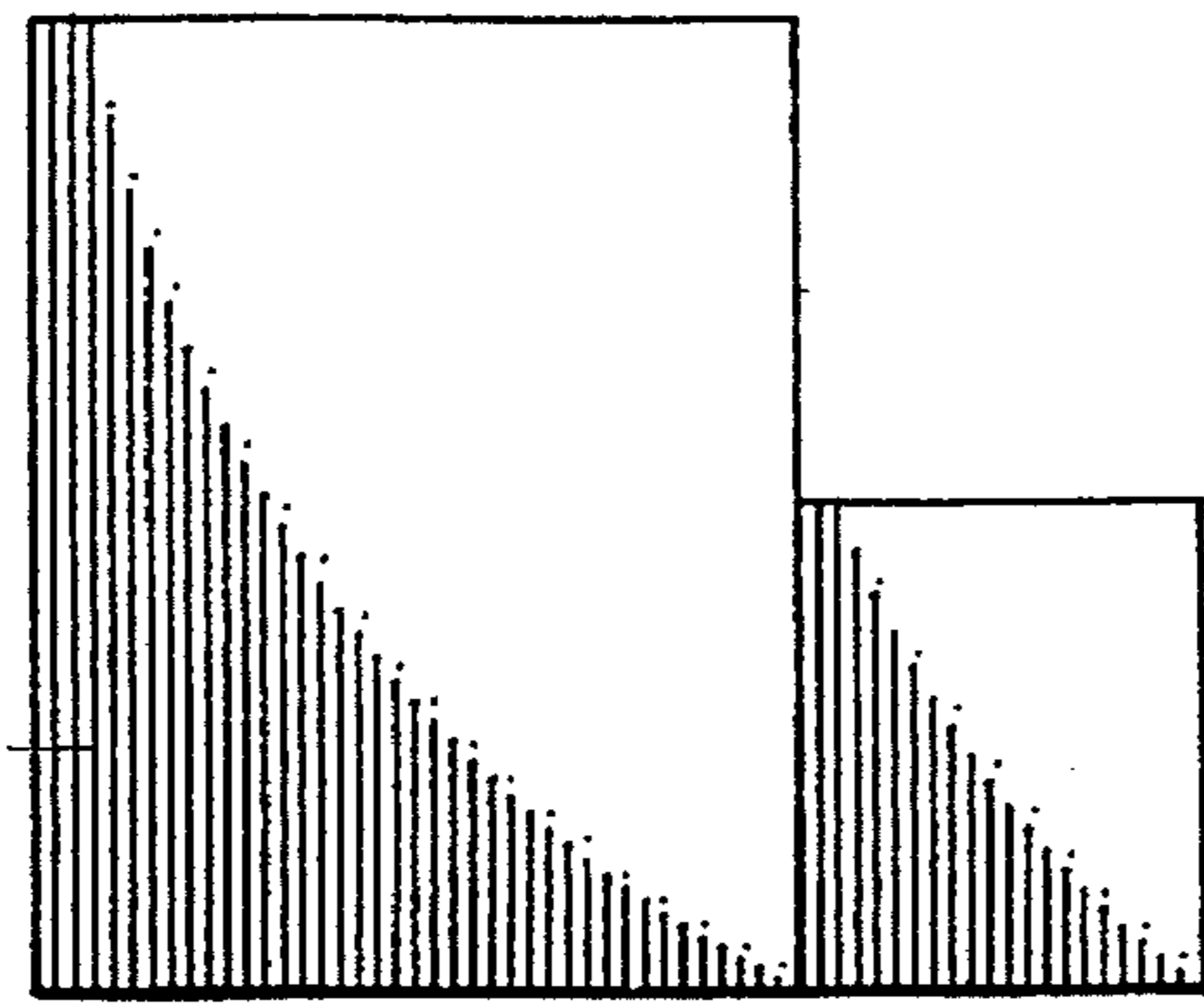

Fig 5

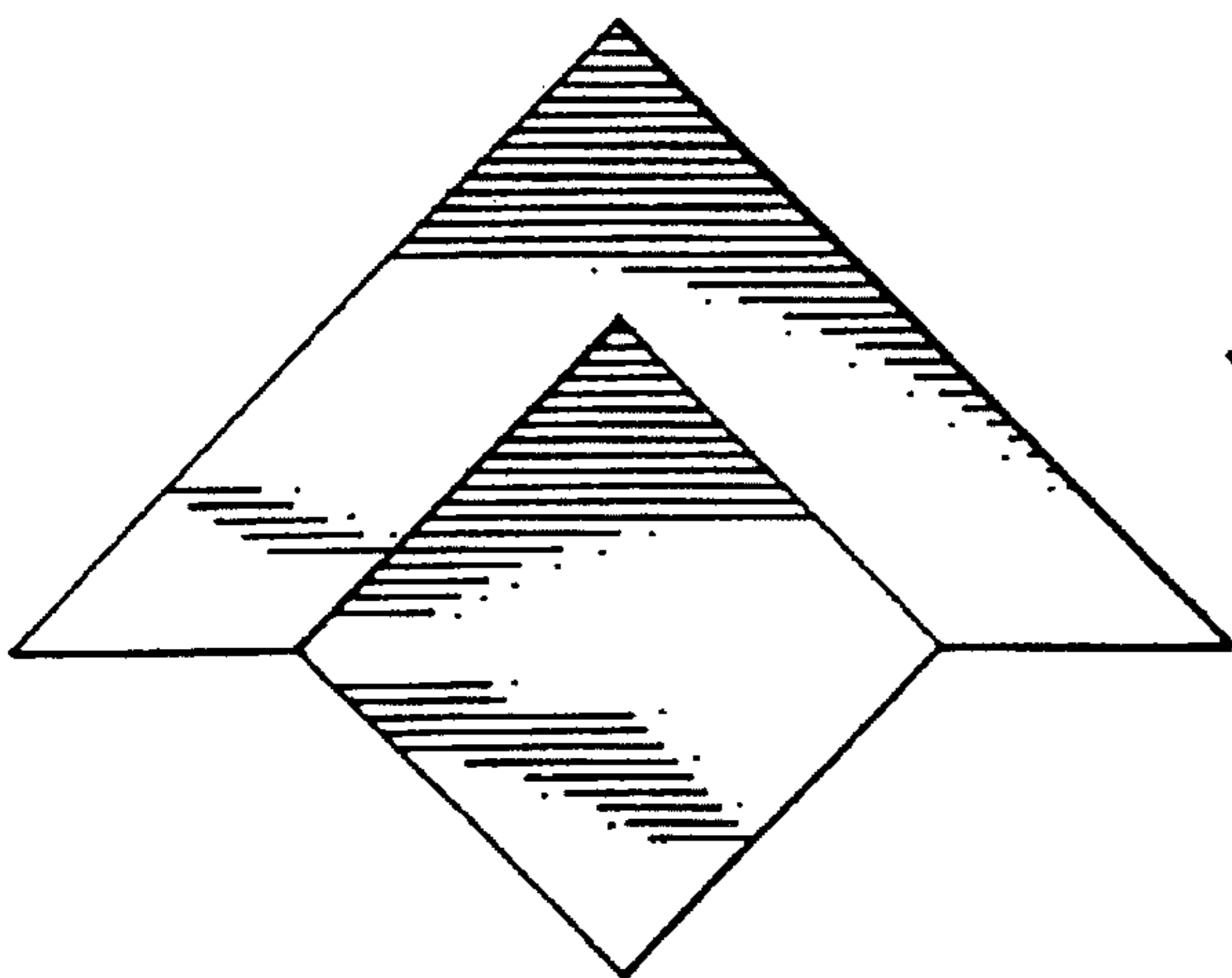

Fig 6

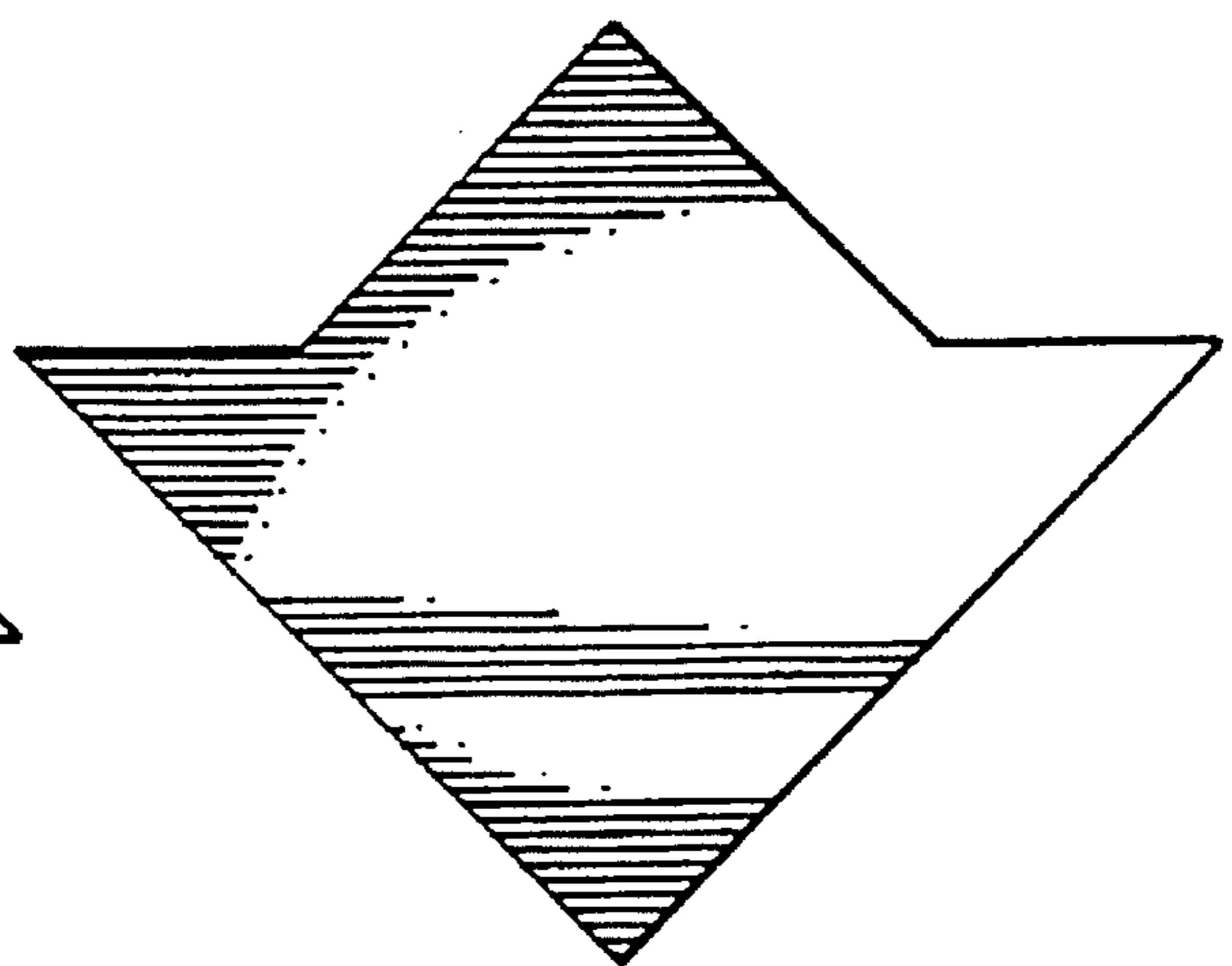

FIG. 7

