



US00D380678S

# United States Patent [19]

Borgstede et al.

[11] Patent Number: **Des. 380,678**

[45] Date of Patent: **\*\*Jul. 8, 1997**

[54] **POURING SPOUT ATTACHMENT FOR A PAINT CAN**

[76] Inventors: **Eric Borgstede; Robert Love**, both of 1580 Harbor Dr., Apt. 318, Slidell, La. 70458

[\*\*] Term: **14 Years**

[21] Appl. No.: **52,549**

[22] Filed: **Apr. 5, 1996**

[51] LOC (6) Cl. .... **09-07**

[52] U.S. Cl. .... **D9/440**

[58] Field of Search ..... D9/434, 435, 440, D9/447, 449; D32/53-54; 220/695, 698, 700; 222/567, 570

[56] **References Cited**

**U.S. PATENT DOCUMENTS**

D. 358,915 5/1995 O'Donoghue ..... D32/54  
3,221,955 12/1965 Banaszak ..... D9/447 X

**FOREIGN PATENT DOCUMENTS**

126333 6/1928 Switzerland ..... 222/567  
2246757 2/1992 United Kingdom ..... 222/567

*Primary Examiner*—James Gandy  
*Assistant Examiner*—Cathrin B. Matta

[57] **CLAIM**

The ornamental design for a pouring spout attachment for a paint can, as shown and described.

**DESCRIPTION**

FIG. 1 is a front elevational view of the pouring spout attachment for a paint can showing our new design; FIG. 2 is a rear elevational view thereof; FIG. 3 is a right view thereof; FIG. 4 is a left view thereof; FIG. 5 is a cross-sectional view taken vertically through the mid-plane of the device at line 5—5 of FIG. 1. FIG. 6 is a top plan view thereof; and, FIG. 7 is a bottom plan view thereof.

**1 Claim, 3 Drawing Sheets**

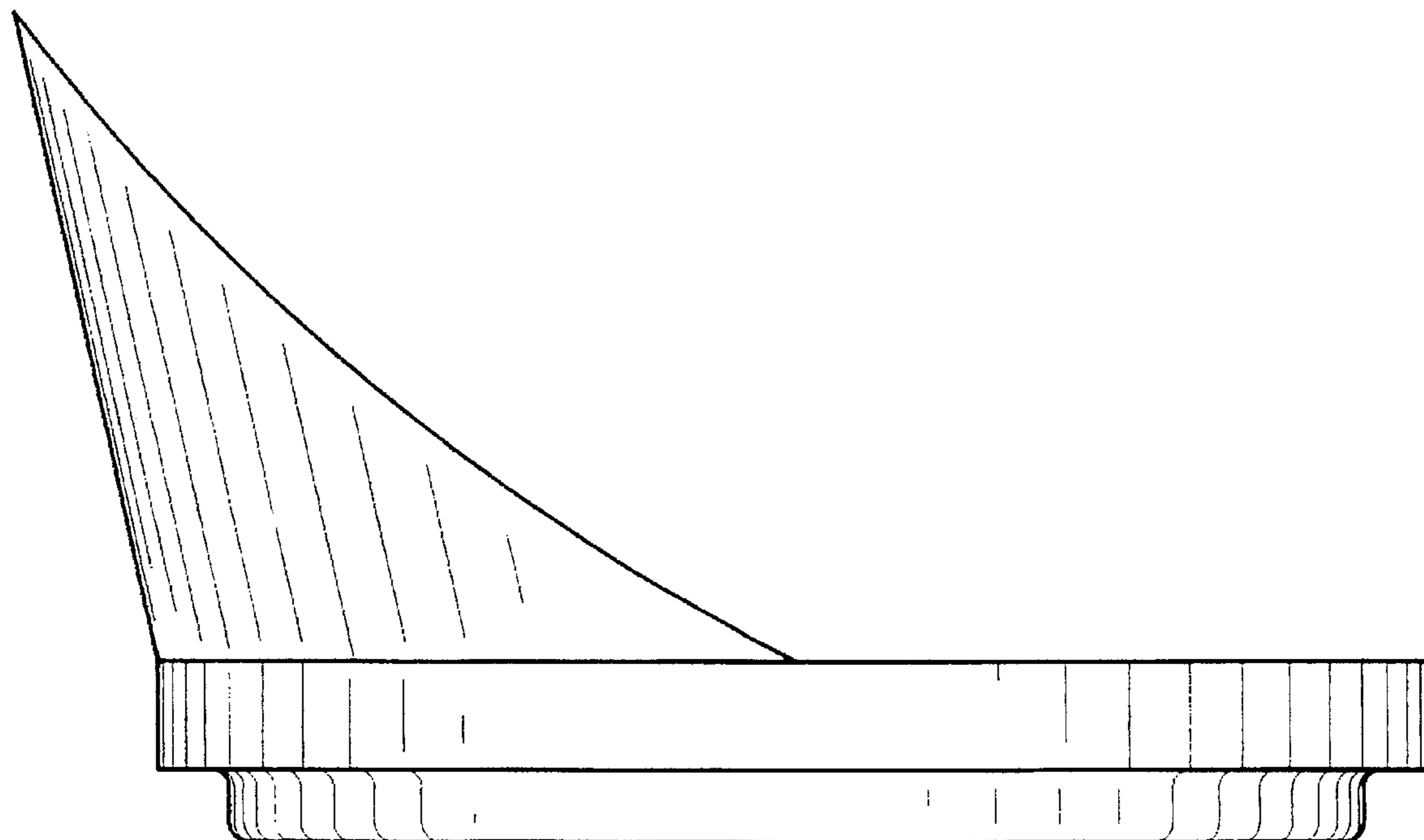

FIG. 1

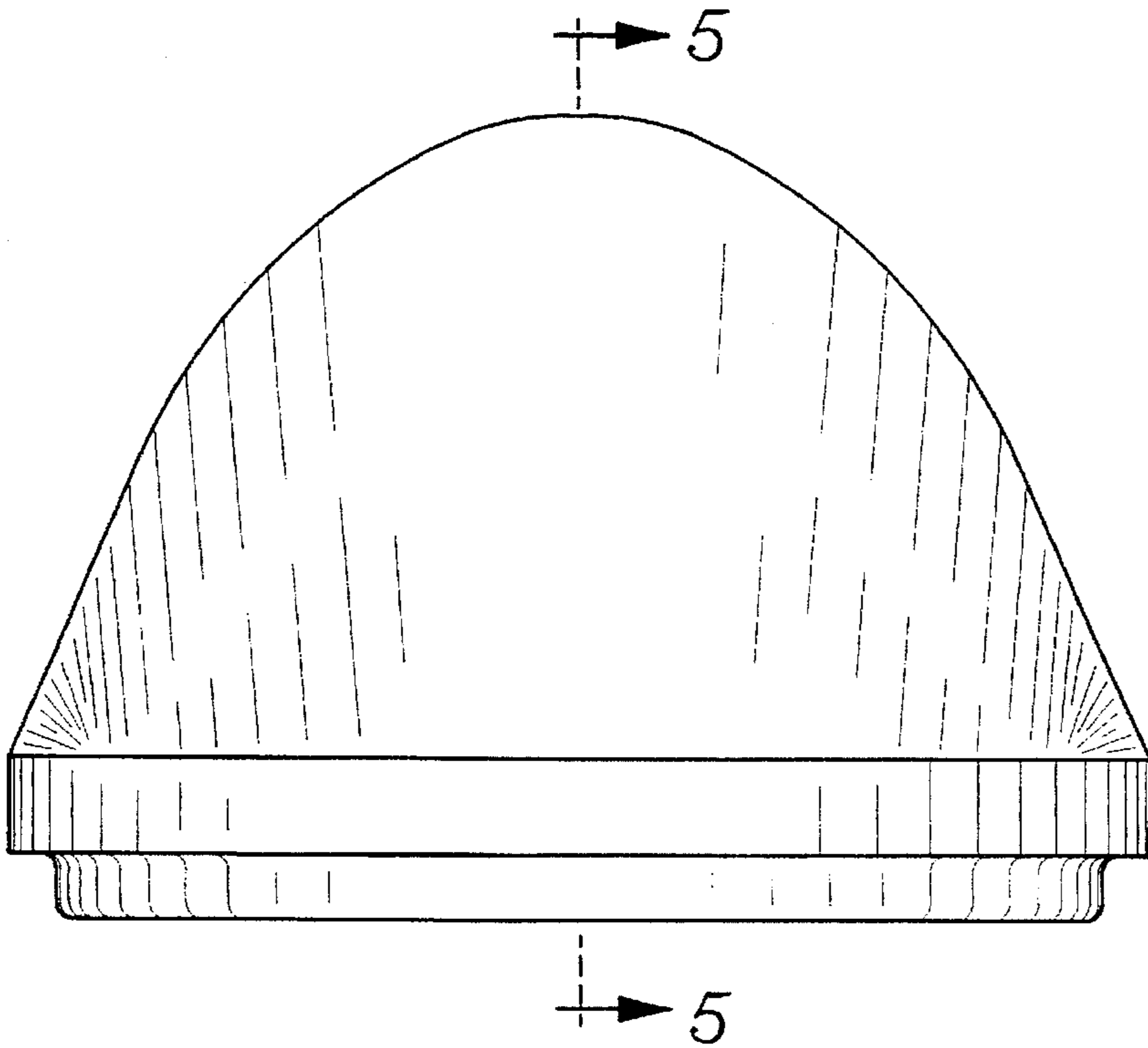

FIG. 2

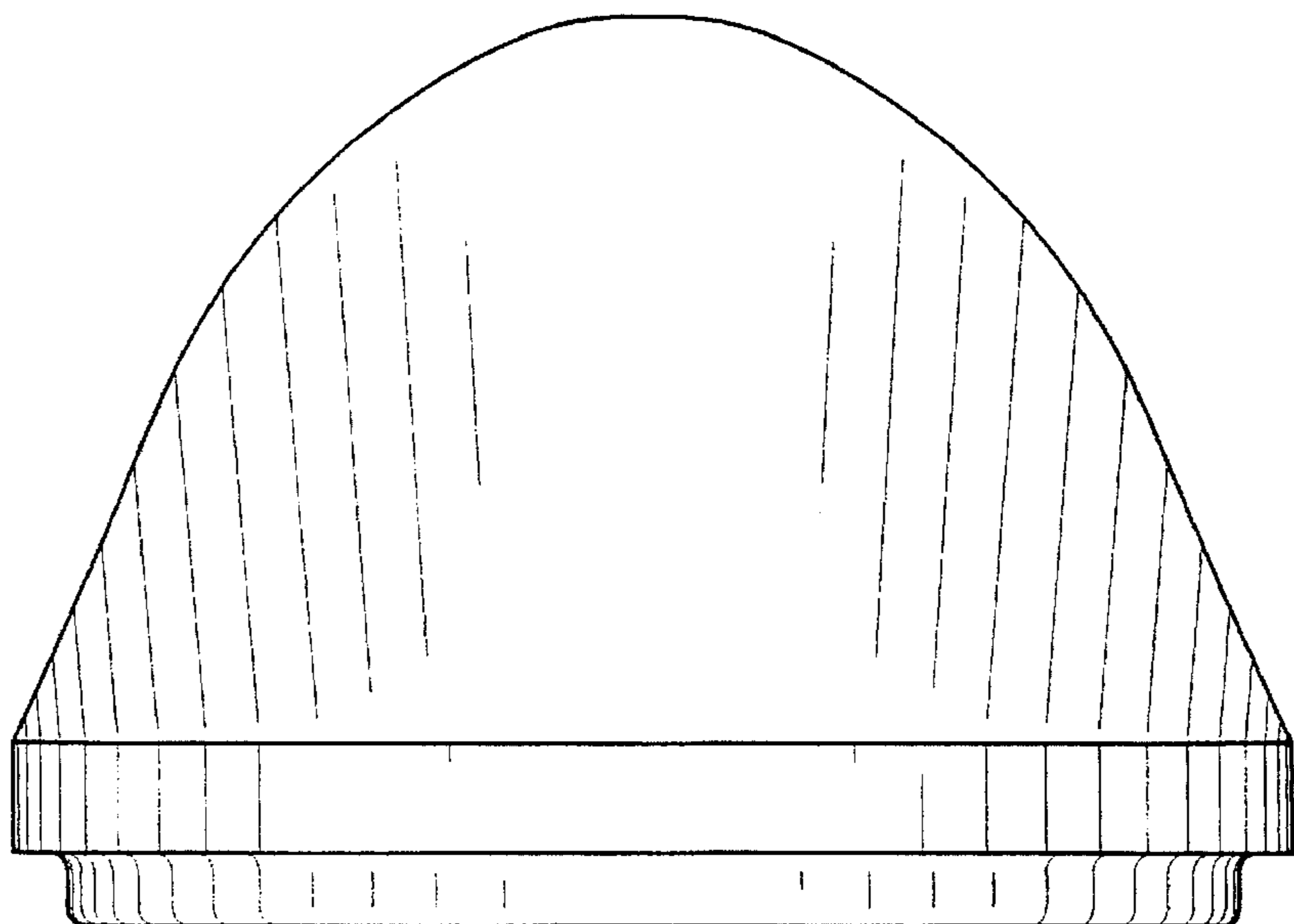

FIG. 3

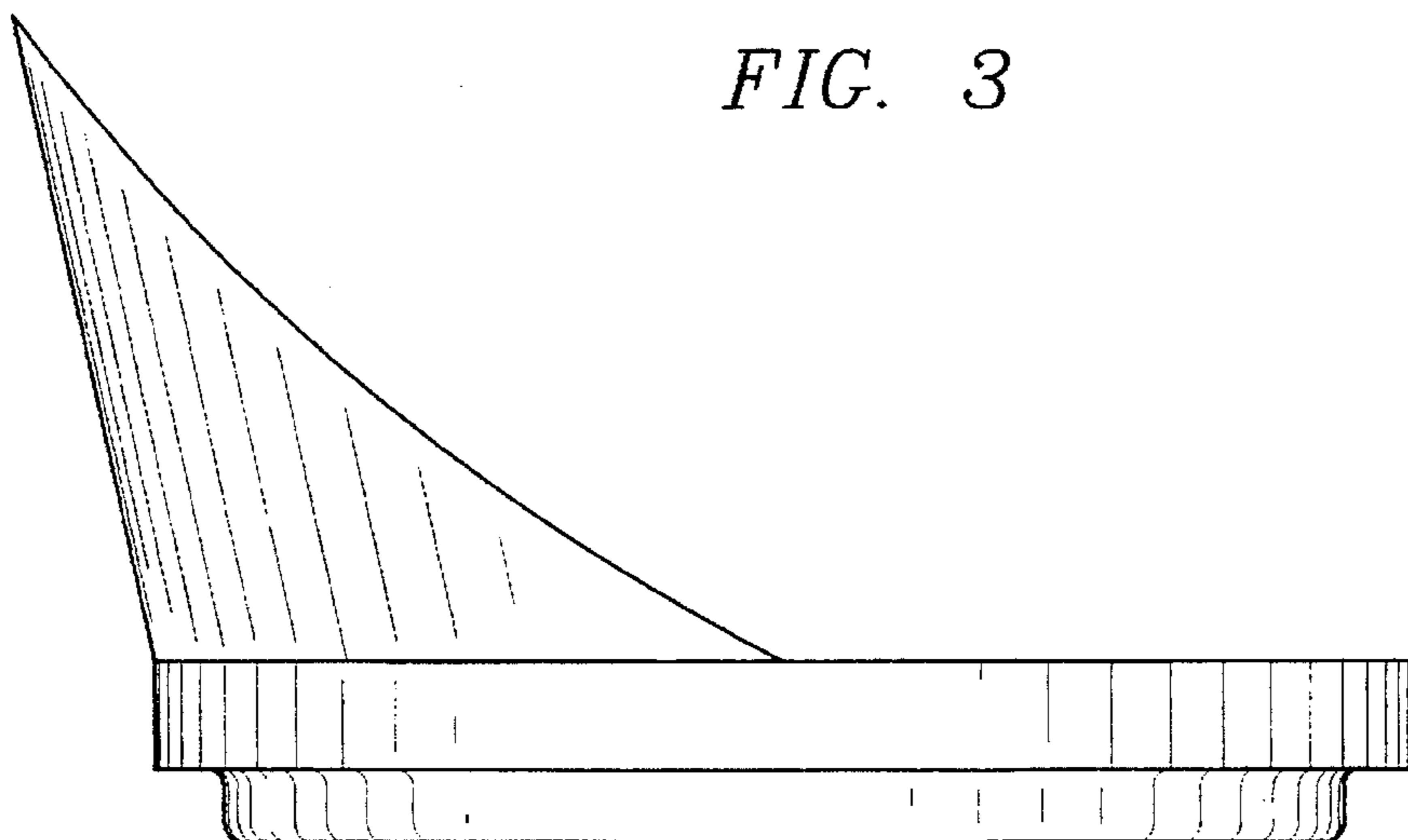

FIG. 4

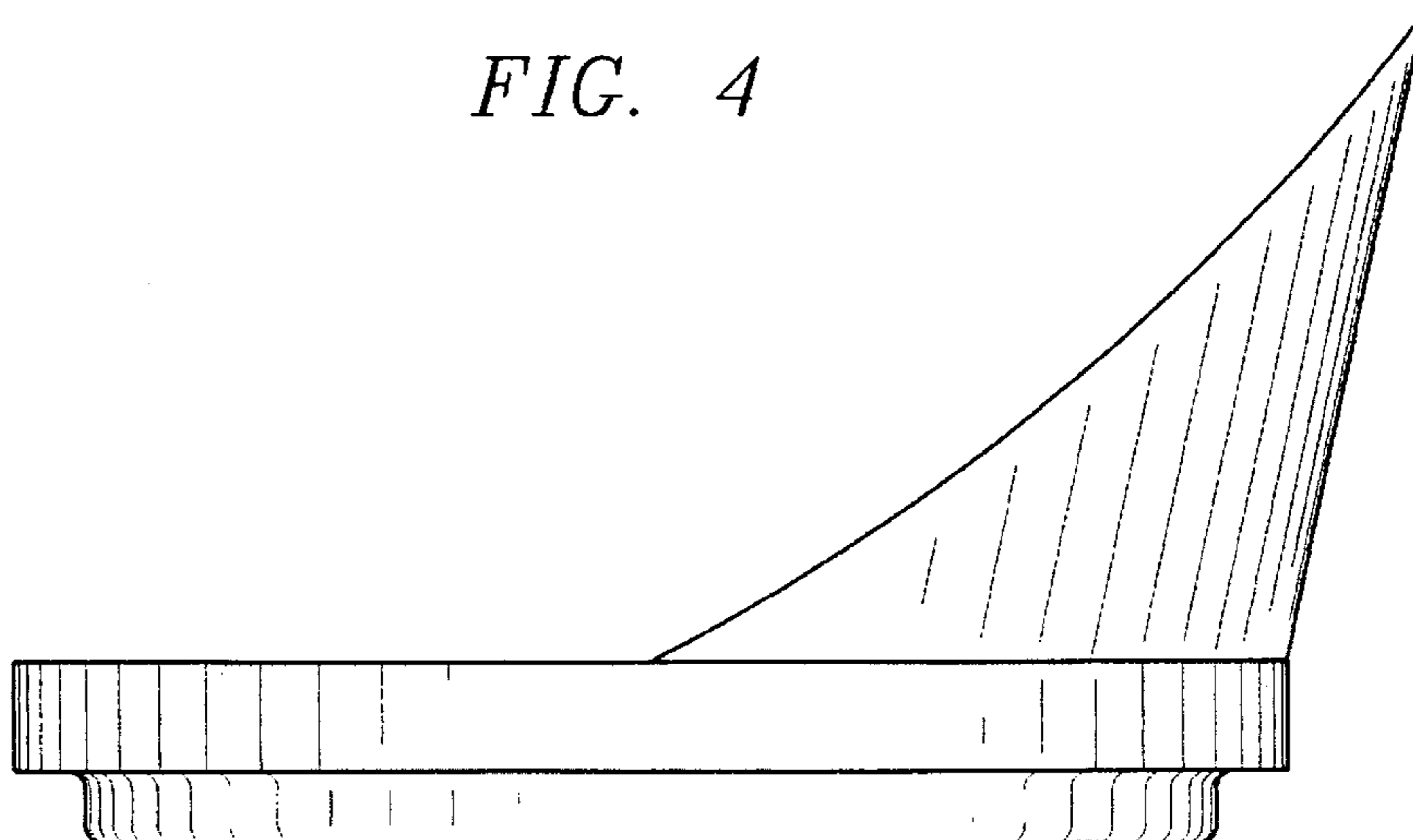

FIG. 5

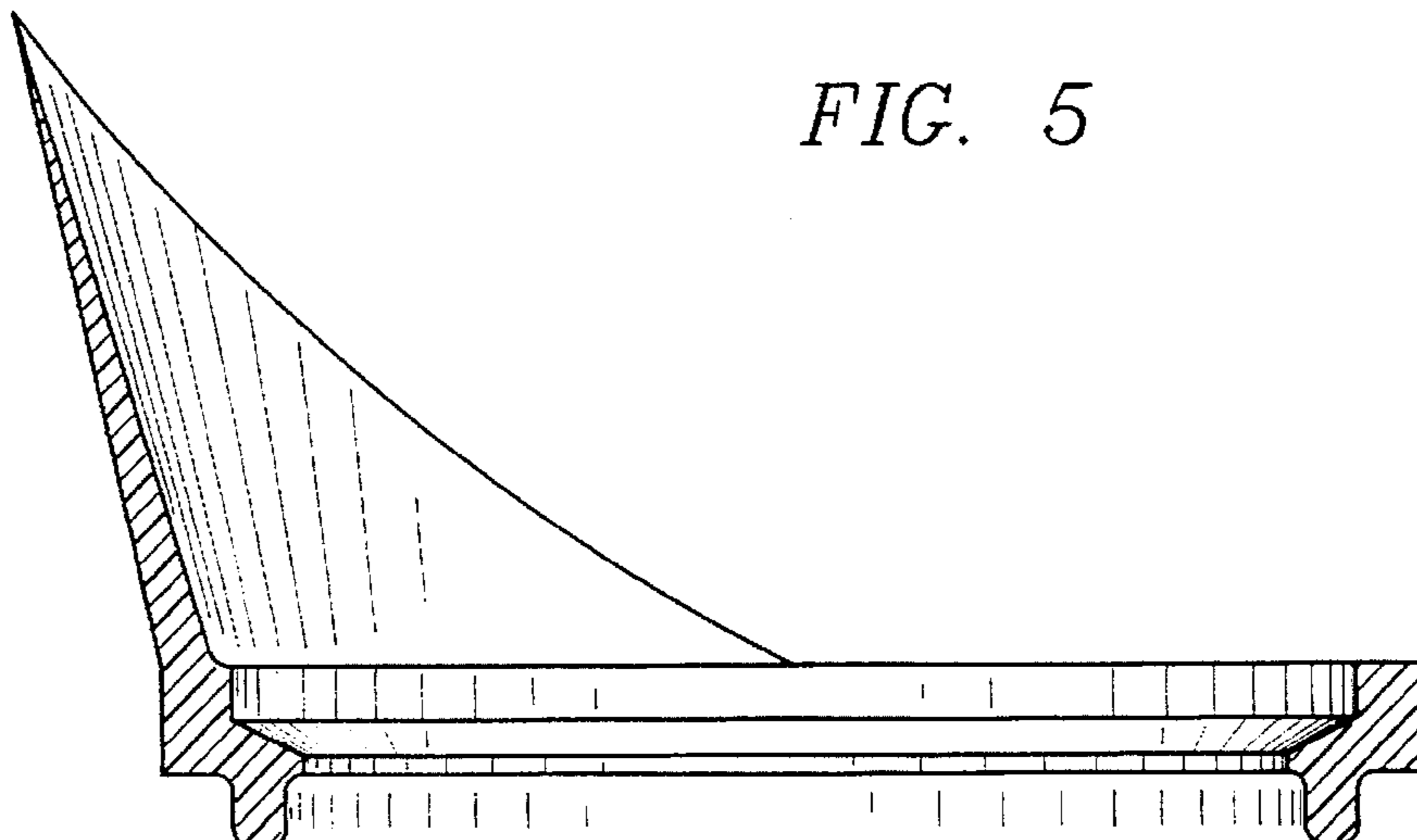

FIG. 6

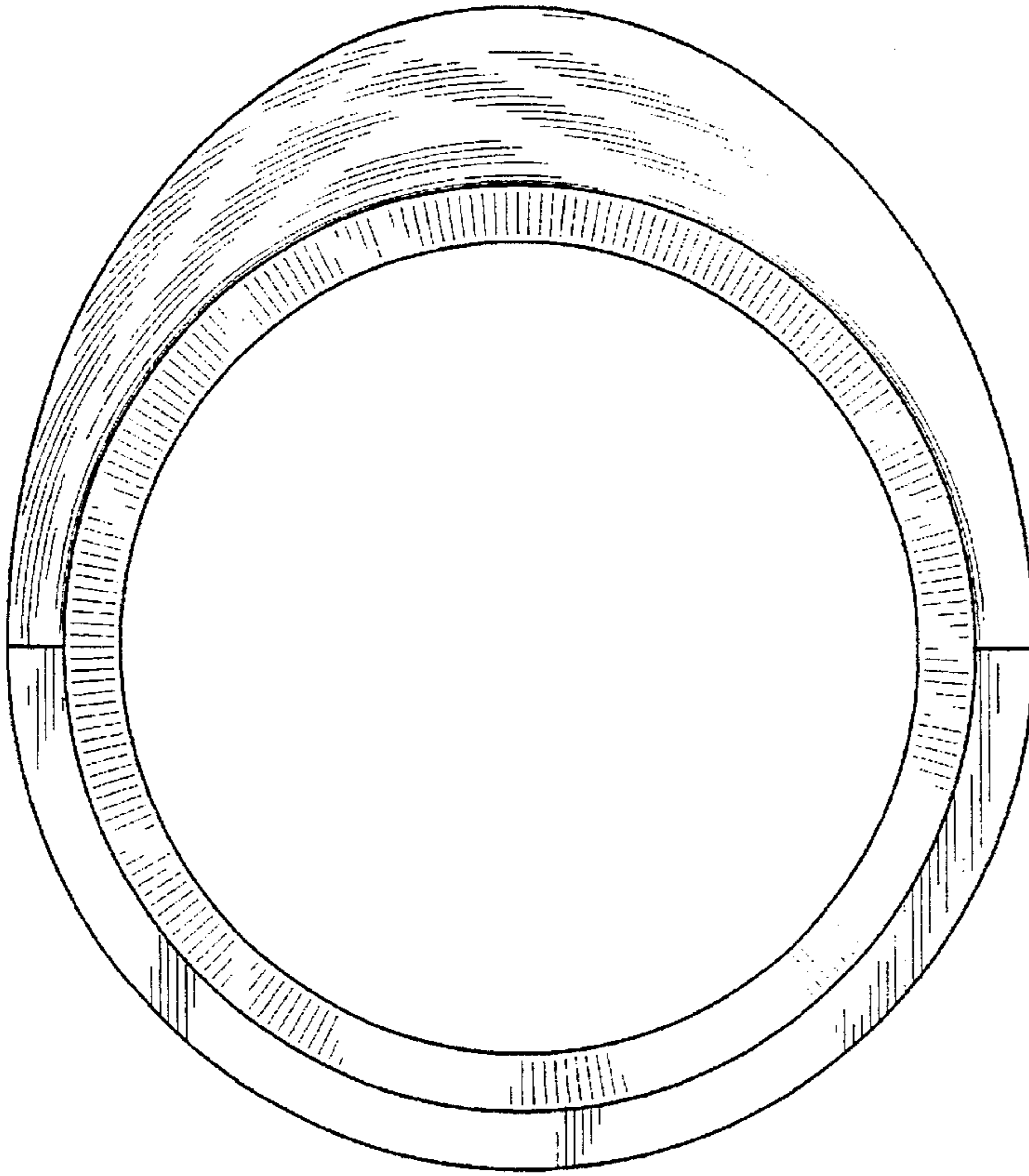

FIG. 7

