



US00D380651S

**United States Patent** [19]  
**Herrera**

[11] **Patent Number: Des. 380,651**

[45] **Date of Patent: \*\*Jul. 8, 1997**

[54] **BEVERAGE CAN HOLDER**

D. 347,361 5/1994 Herrera ..... D7/606  
D. 350,878 9/1994 Hockstra ..... D7/619

[76] Inventor: **Frederick F. Herrera**, 9414 Brenham Ct., Houston, Tex. 77064-7430

*Primary Examiner*—Terry A. Wallace  
*Attorney, Agent, or Firm*—Arnold, White & Durkee

[\*\*] Term: **14 Years**

[57] **CLAIM**

[21] Appl. No.: **51,795**

The ornamental design for a beverage can holder, as shown and described.

[22] Filed: **Mar. 18, 1996**

[51] LOC (6) Cl. .... **07-06**

[52] U.S. Cl. .... **D7/619**

[58] **Field of Search** ..... D7/619-624; D34/17; 211/71, 74; 220/737, 739; 280/47.26, 27.27

**DESCRIPTION**

FIG. 1 is a perspective view of a beverage can holder, showing my new design;  
FIG. 2 is a side elevational view;  
FIG. 3 is a front elevational view;  
FIG. 4 is a rear elevational view;  
FIG. 5 is a top plan view; and,  
FIG. 6 is a bottom plan view.

[56] **References Cited**

**U.S. PATENT DOCUMENTS**

D. 290,922 7/1987 Herrera .  
D. 310,943 10/1990 Spencer, Sr. .... D7/619  
D. 335,614 5/1993 Diab ..... D7/619

**1 Claim, 2 Drawing Sheets**

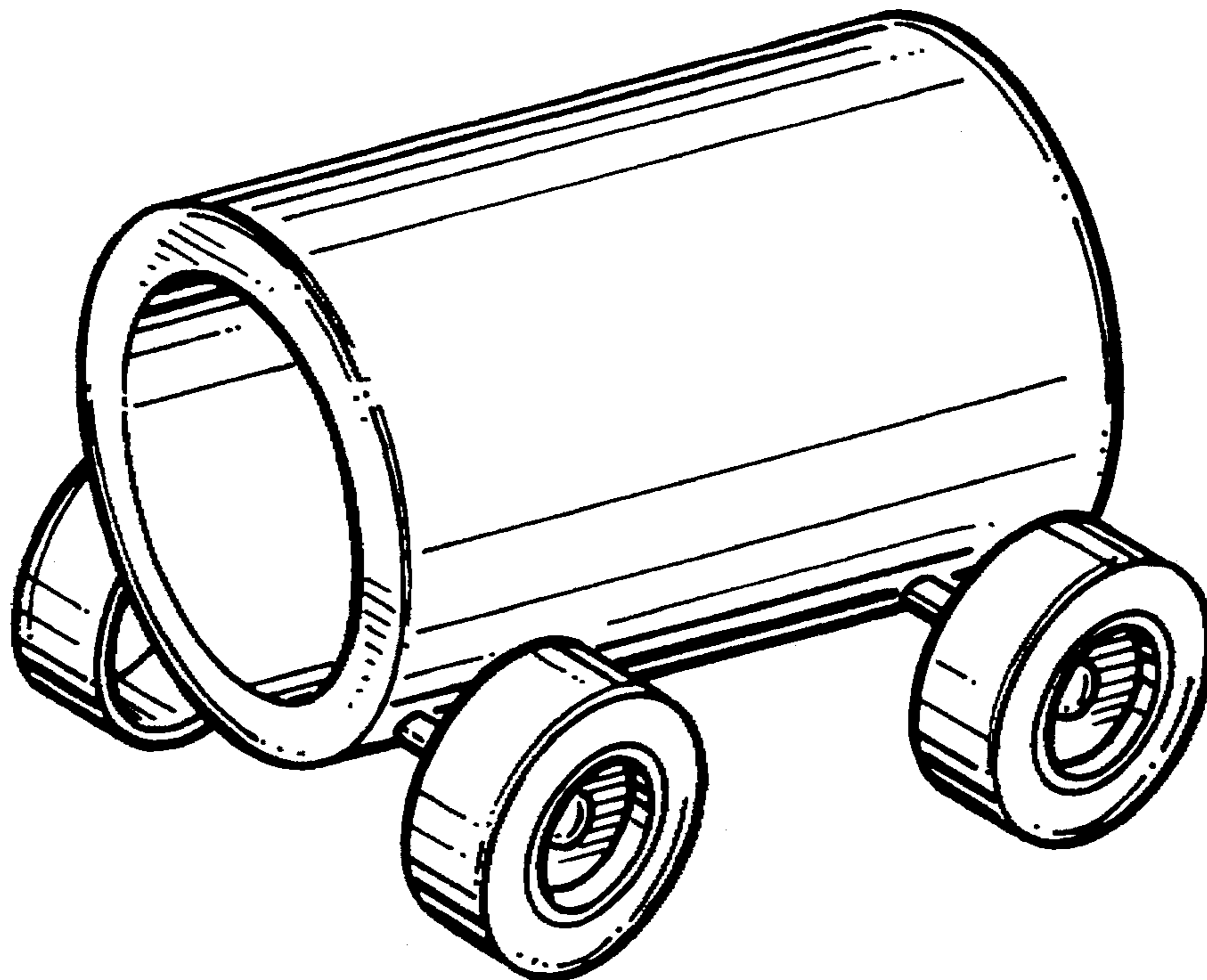

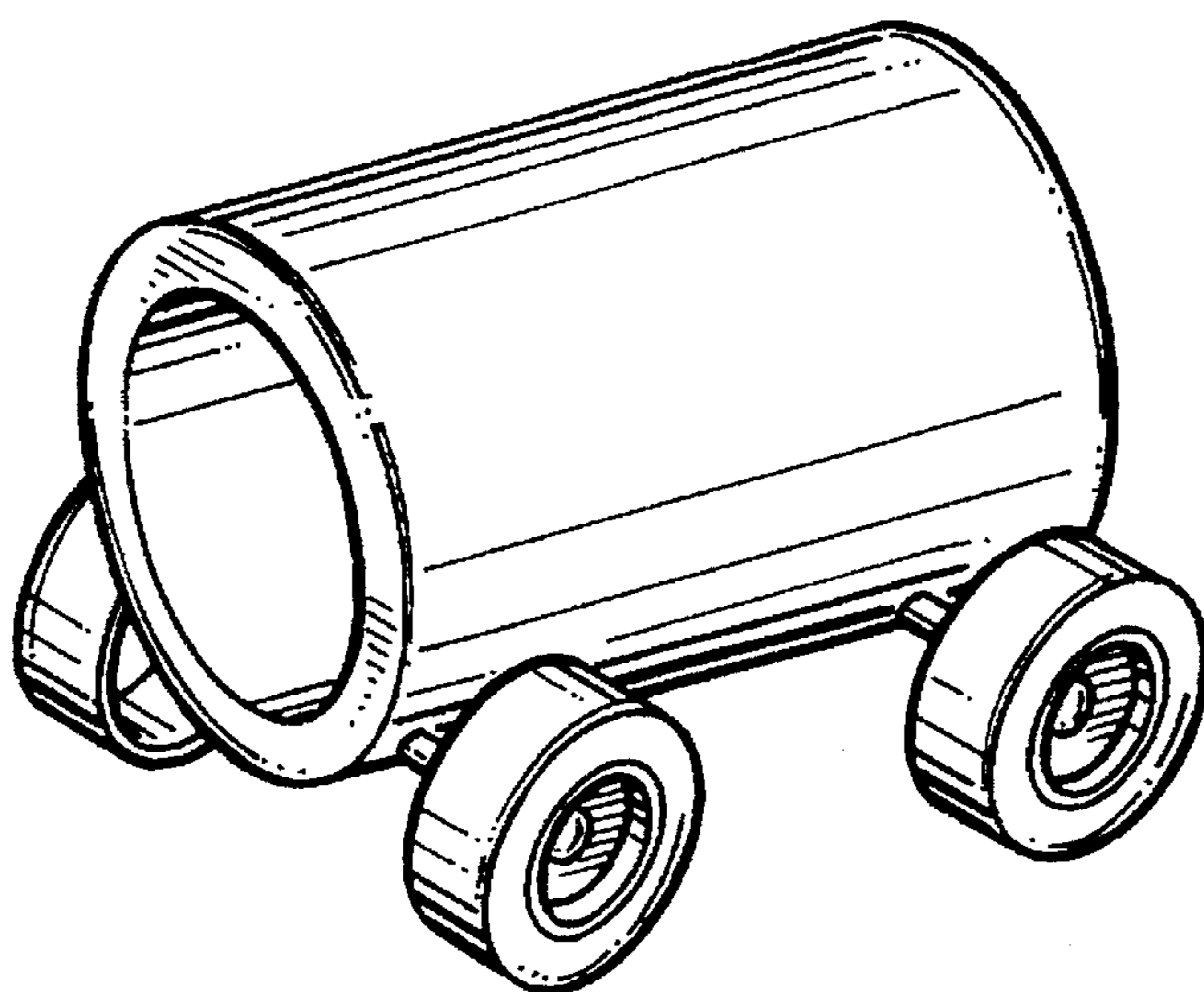

FIG. 1

FIG. 2

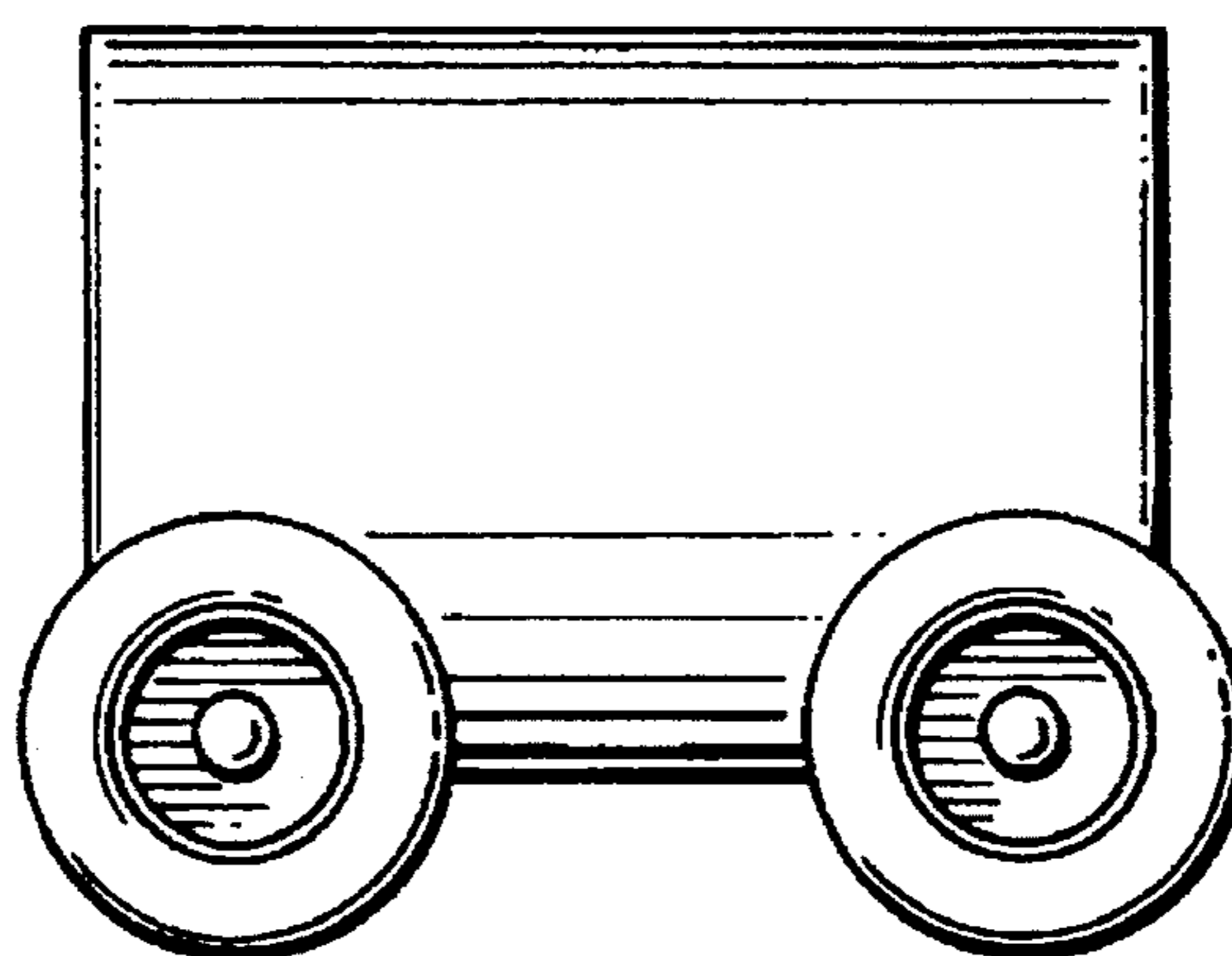

FIG. 3

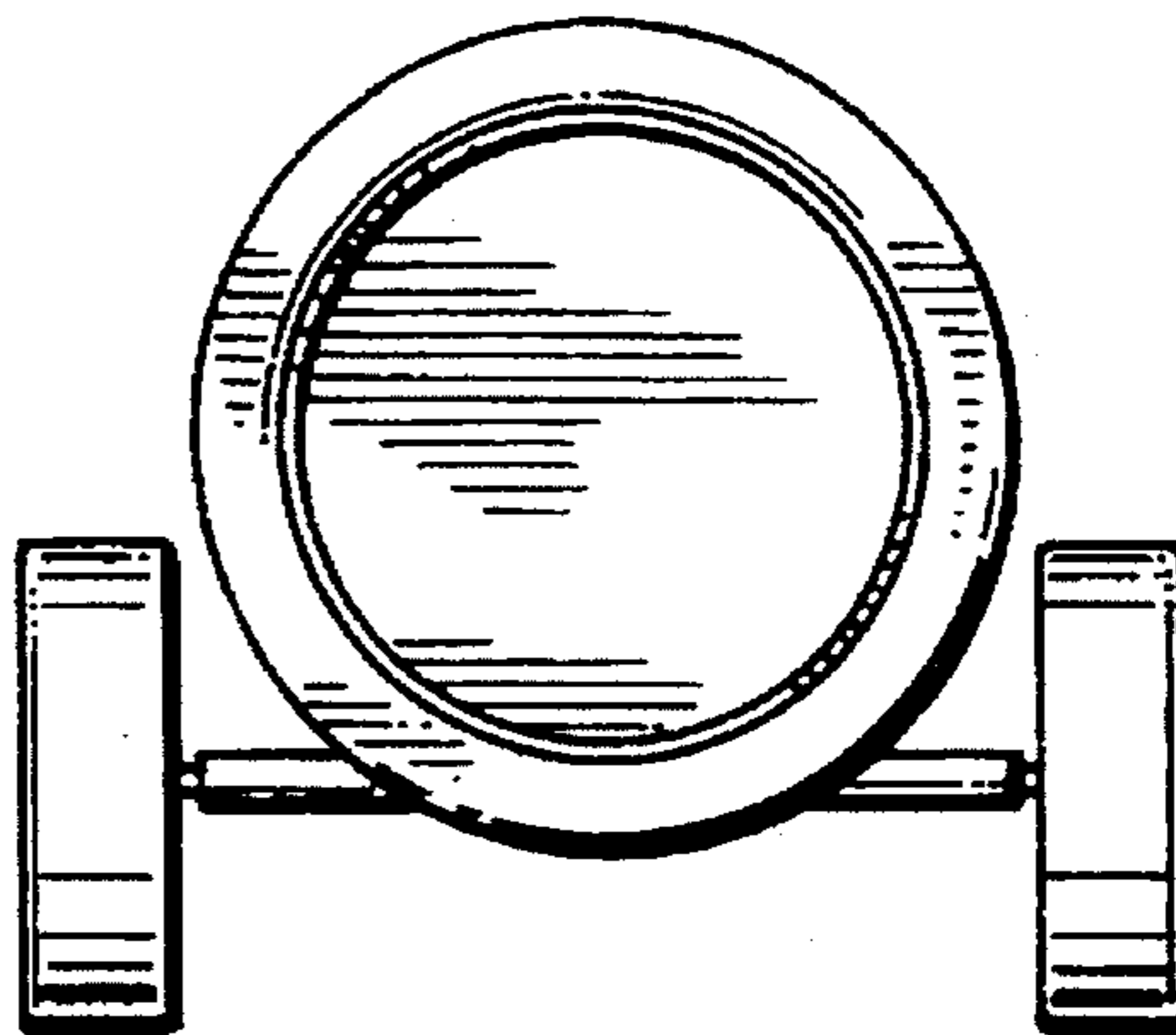
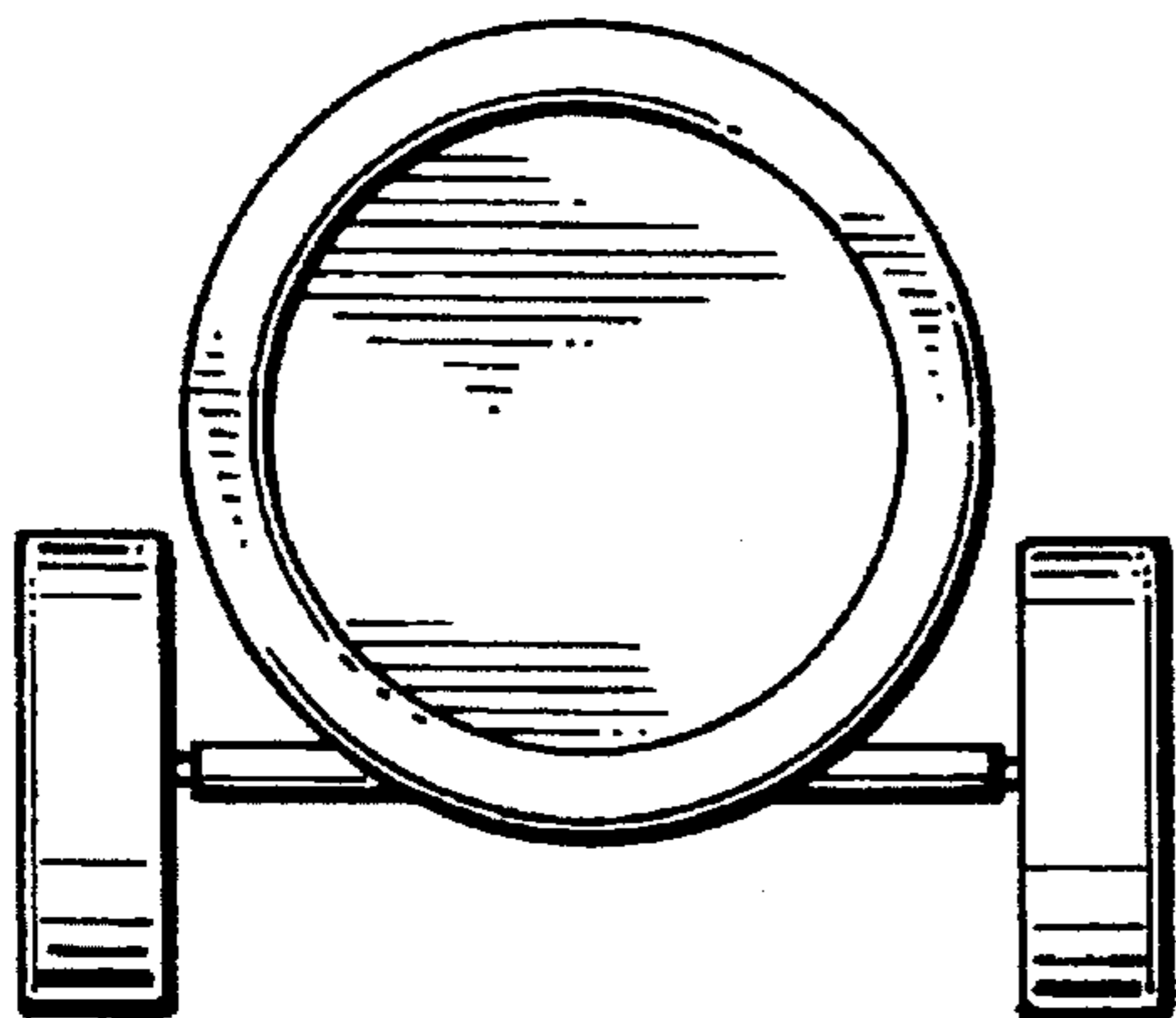
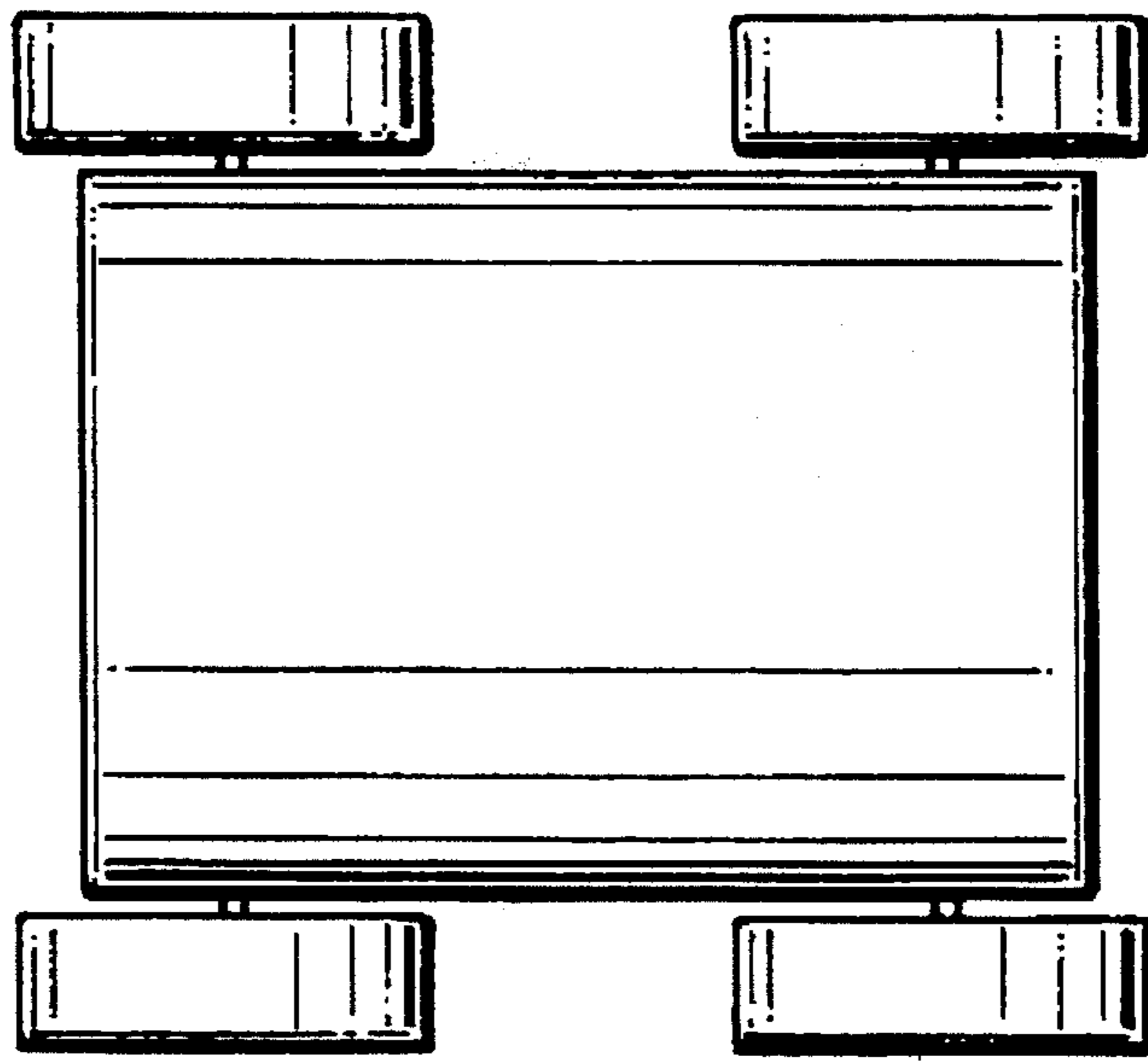
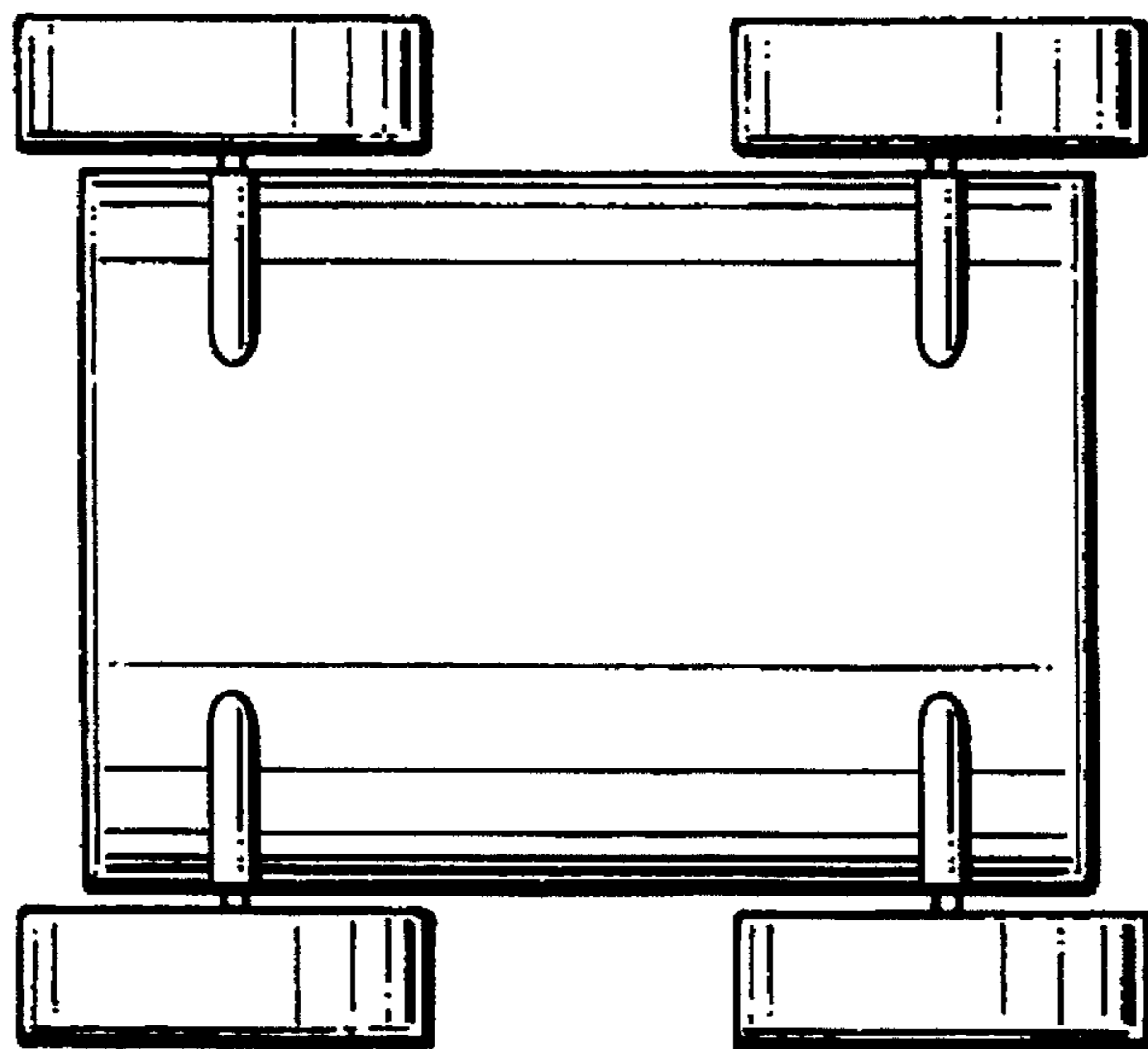

FIG. 4



**FIG. 5**



**FIG. 6**