



US00D380635S

United States Patent [19]

[11] Patent Number: **Des. 380,635**

Brotz

[45] Date of Patent: ****Jul. 8, 1997**

[54] **STAPLING TABLE**

[76] Inventor: **Gregory R. Brotz**, P.O. Box 1322,
Sheboygan, Wis. 53081

[**] Term: **14 Years**

[21] Appl. No.: **40,292**

[22] Filed: **Jun. 14, 1995**

[51] LOC (6) Cl. **06-03**

[52] U.S. Cl. **D6/511**

[58] Field of Search D6/511, 510, 512;
227/5, 130, 131, 151, 154; 108/90; 206/371,
471, 557; 220/735

[56] **References Cited**

U.S. PATENT DOCUMENTS

D. 348,904	7/1994	Linder	D6/511 X
D. 367,387	2/1996	Sweere	D6/511
2,897,500	8/1959	Lang	227/151
4,932,579	6/1990	Simonec et al.	227/5

Primary Examiner—B. J. Bullock
Assistant Examiner—Linda Brooks
Attorney, Agent, or Firm—William Nitkin

[57] **CLAIM**

The ornamental design for a stapling table, as shown and described.

DESCRIPTION

FIG. 1 is a top plan view of a stapling table showing my new design;

FIG. 2 is a bottom plan view thereof;

FIG. 3 is a rear elevational view thereof;

FIG. 4 is a front elevational view thereof;

FIG. 5 is a right side elevational view thereof;

FIG. 6 is a left side elevational view thereof; and,

FIG. 7 is a right side perspective view thereof.

The broken line showing of a stapler in FIGS. 1, 3, 4, 5, 6, and 7 is for illustrative purposes only and forms no part of the claimed design.

1 Claim, 4 Drawing Sheets

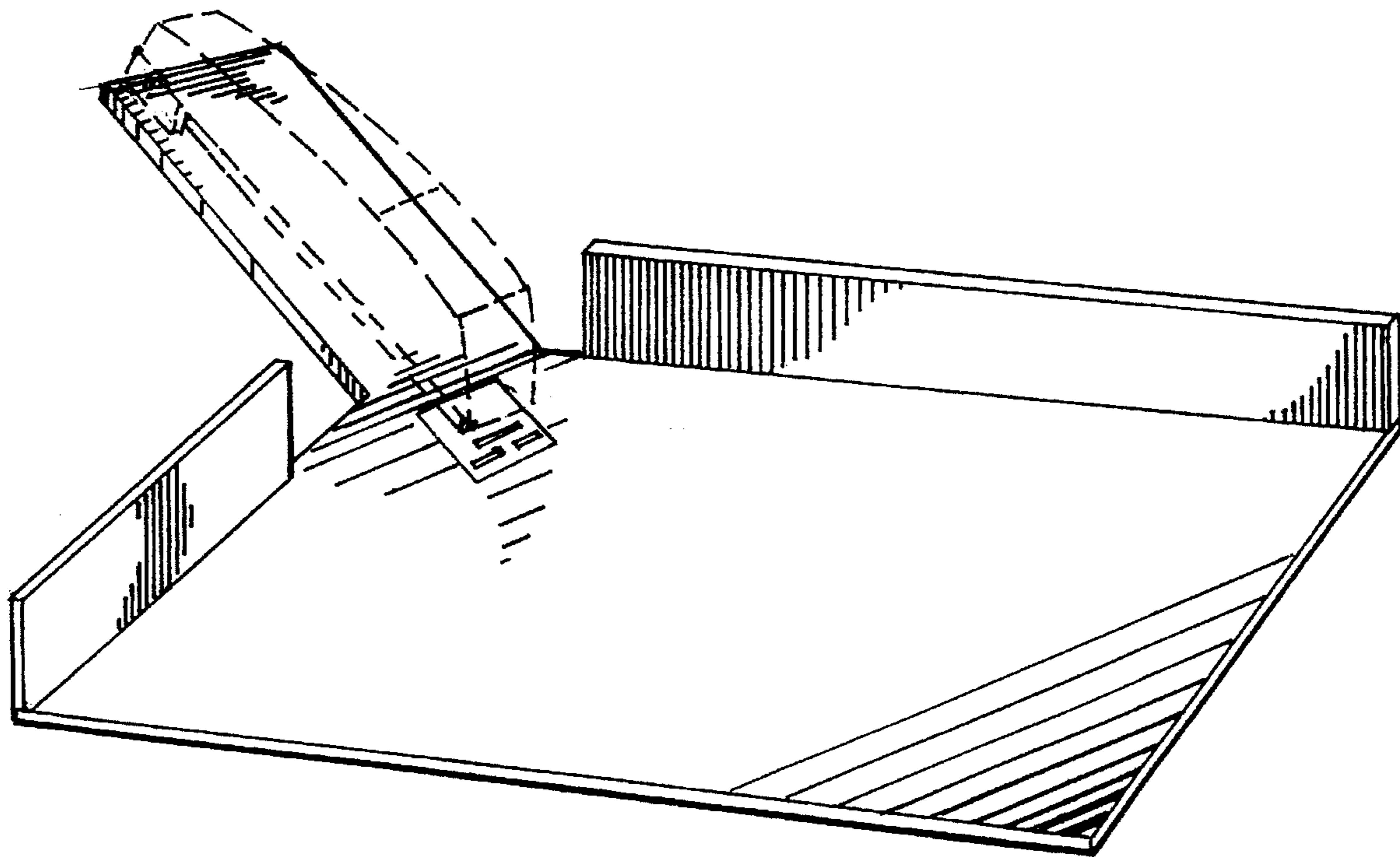

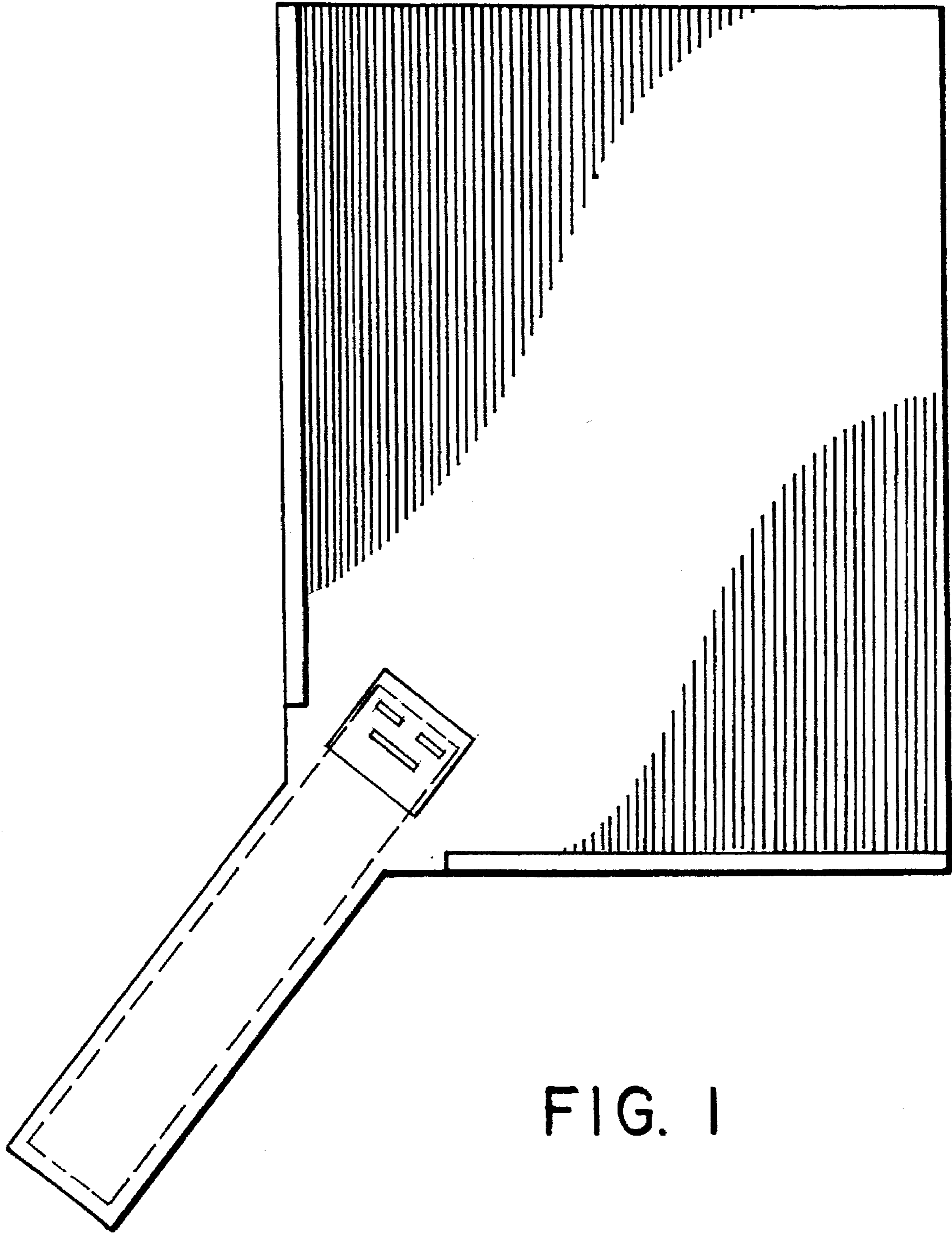

FIG. 1

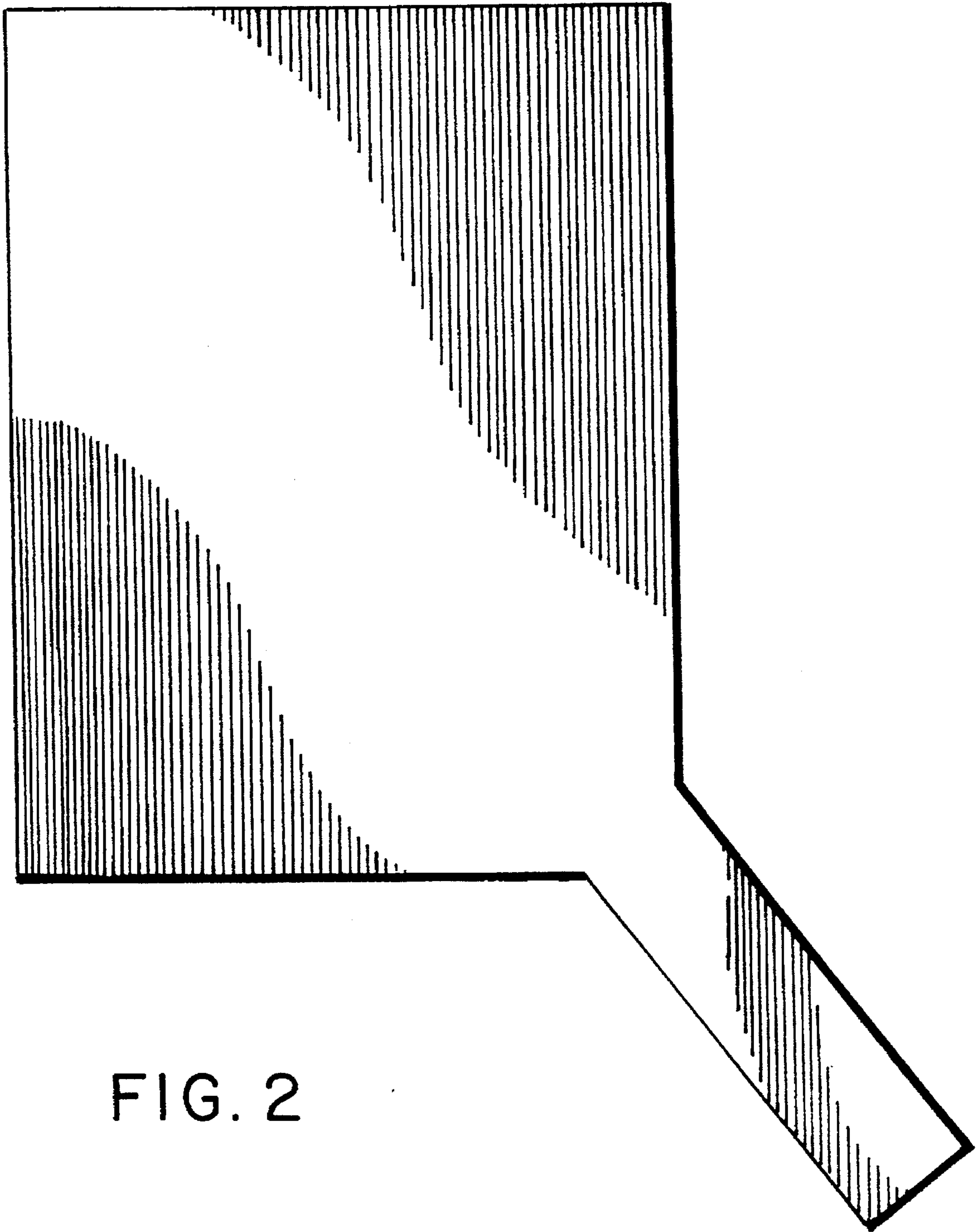

FIG. 2

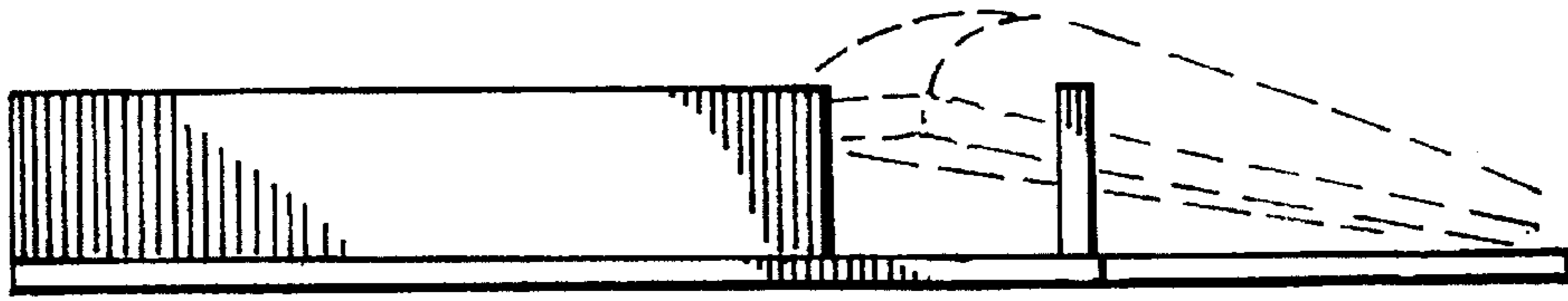

FIG. 3

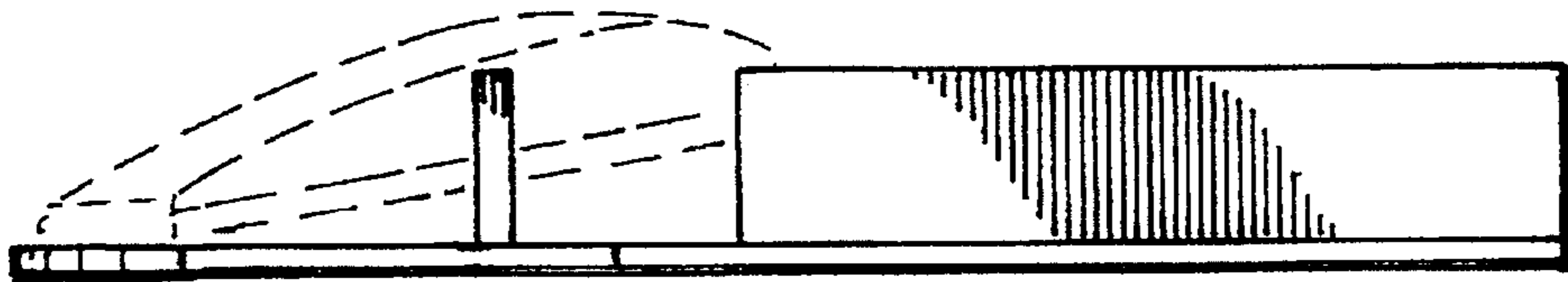

FIG. 4

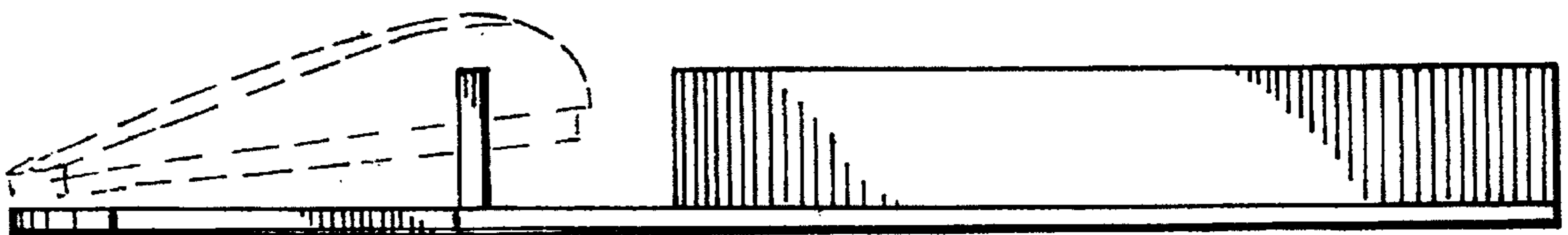

FIG. 5

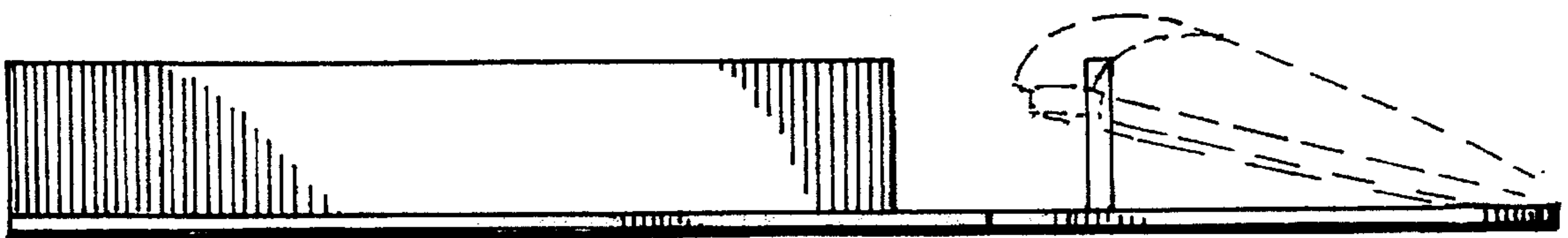

FIG. 6

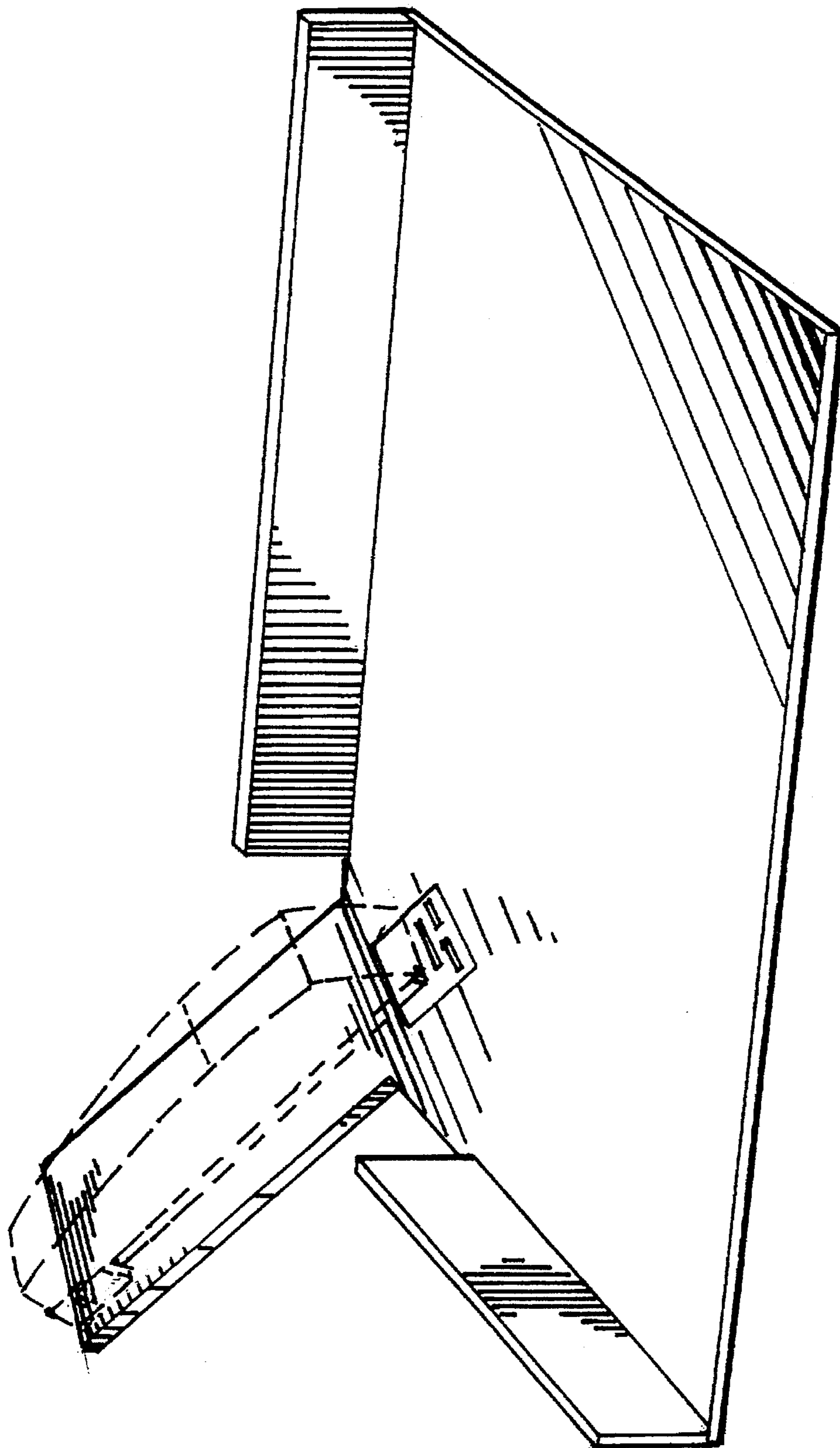

FIG. 7