



US00D380625S

United States Patent [19]
Yeh

[11] **Patent Number: Des. 380,625**
[45] **Date of Patent: **Jul. 8, 1997**

[54] **JEWELRY CASE**
[75] **Inventor: Don-Fong Yeh, Taipei, Taiwan**
[73] **Assignee: Pan-Ocean Forest Development Co., Ltd., Taipei, Taiwan**
[**] **Term: 14 Years**
[21] **Appl. No.: 53,567**
[22] **Filed: Apr. 25, 1996**
[51] **LOC (6) Cl. 06-04**
[52] **U.S. Cl. D6/441; D6/440; D6/445**
[58] **Field of Search D6/432-448, 396, D6/397; 312/204, 257, 325, 227, 293, 201; D3/273-275, 294-297, 904**

D. 319,153 8/1991 Powell D6/440
D. 322,525 12/1991 Powell D6/440
1,242,916 10/1917 Brooks 312/201

OTHER PUBLICATIONS

Best 1992/93, p. 163; Powell-Traditional Bowed-Front Jewelry Armoire Item #8, bottom of page.

Primary Examiner—Carmen H. Vales-Lado
Attorney, Agent, or Firm—Fitzpatrick, Cella, Harper & Scinto

CLAIM

The ornamental design for a jewelry case, as shown and described.

DESCRIPTION

FIG. 1 is a perspective view of a jewelry case showing my new design;
FIG. 2 is a front elevational view thereof;
FIG. 3 is a rear elevational view thereof;
FIG. 4 is a left side elevational view thereof;
FIG. 5 is a right side elevational view thereof;
FIG. 6 is a top plan view thereof; and,
FIG. 7 is a bottom plan view thereof.

1 Claim, 6 Drawing Sheets

[56] **References Cited**
U.S. PATENT DOCUMENTS

D. 84,471 6/1931 French D6/446 X
D. 116,574 9/1939 Pellegrin et al. D6/441
D. 160,123 9/1950 Reinheimer et al. D6/441
D. 200,475 3/1965 Fortson D6/440
D. 262,169 12/1981 Sonder et al. D6/439
D. 301,416 6/1989 Powell D6/440
D. 314,291 2/1991 Powell D6/440

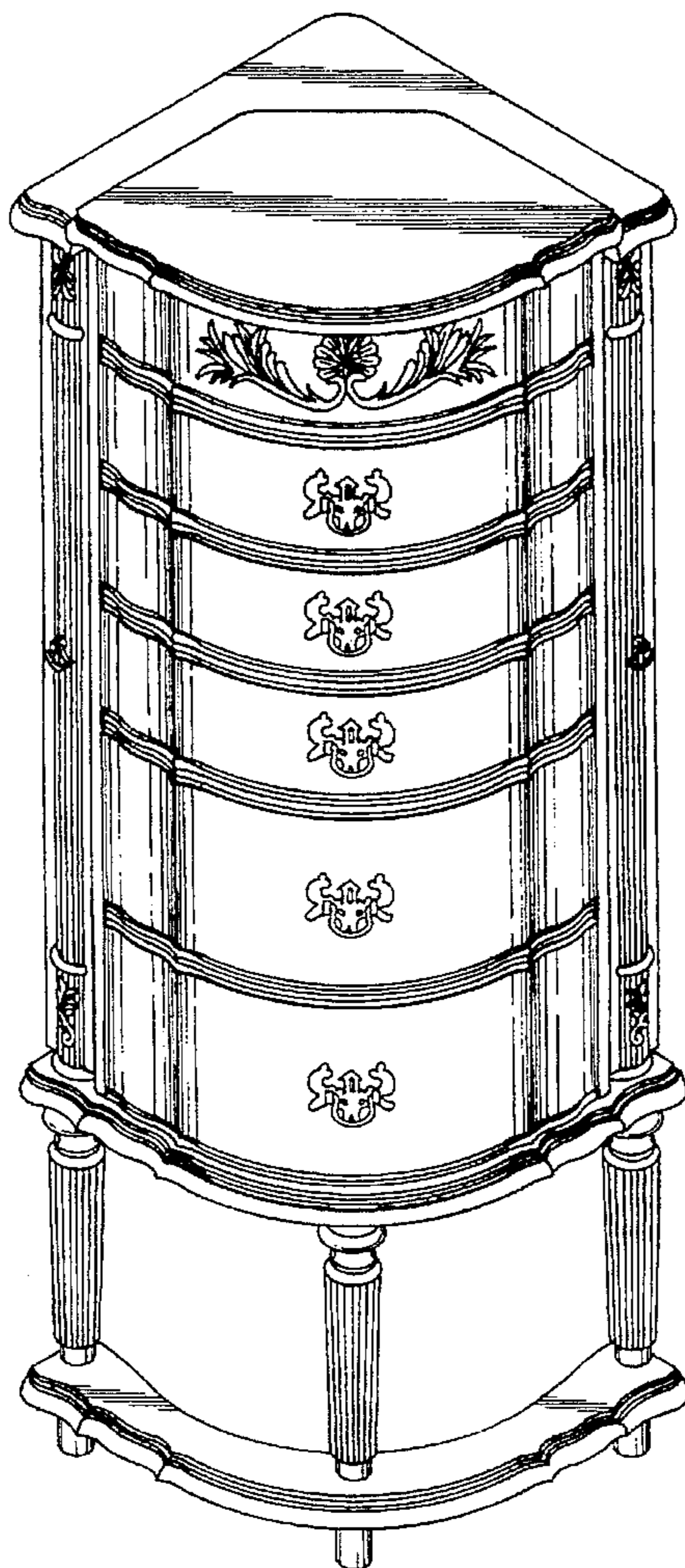

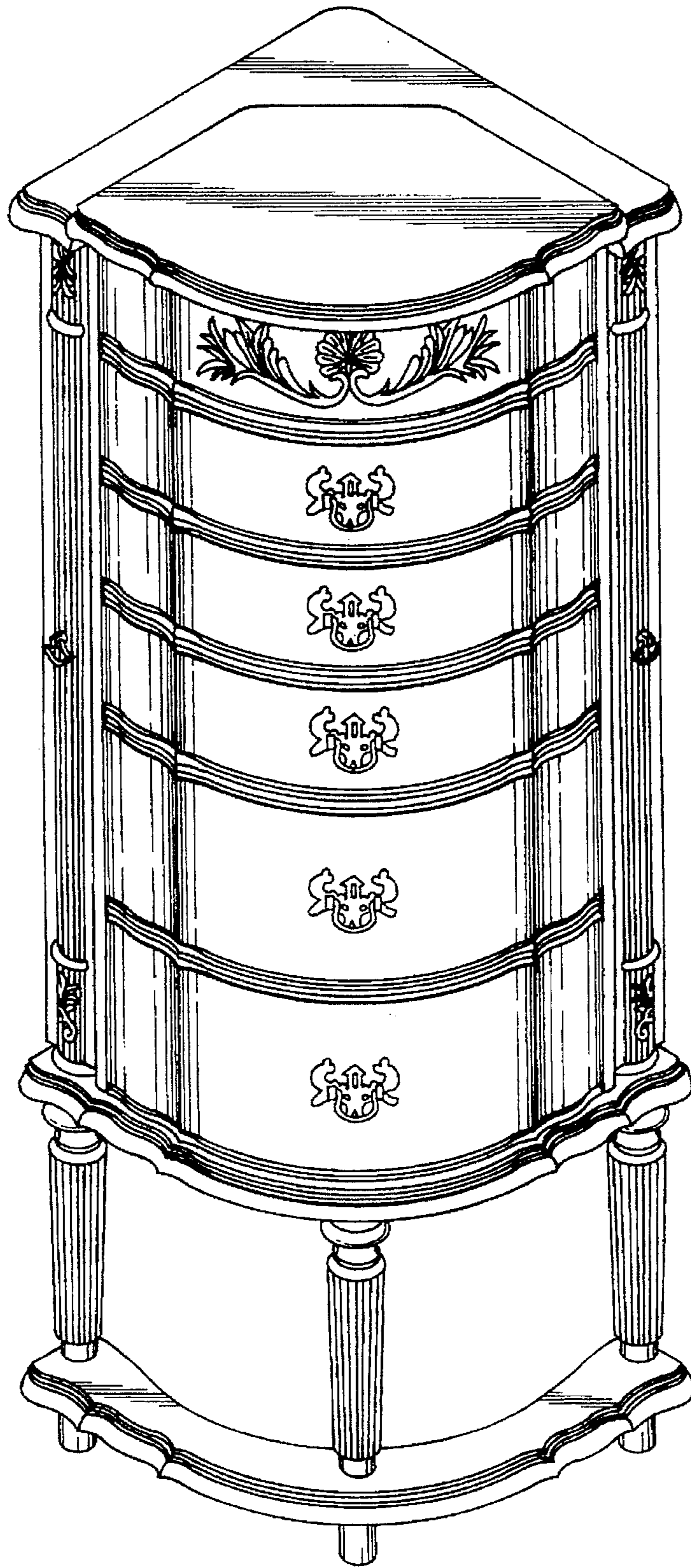

FIG. 1

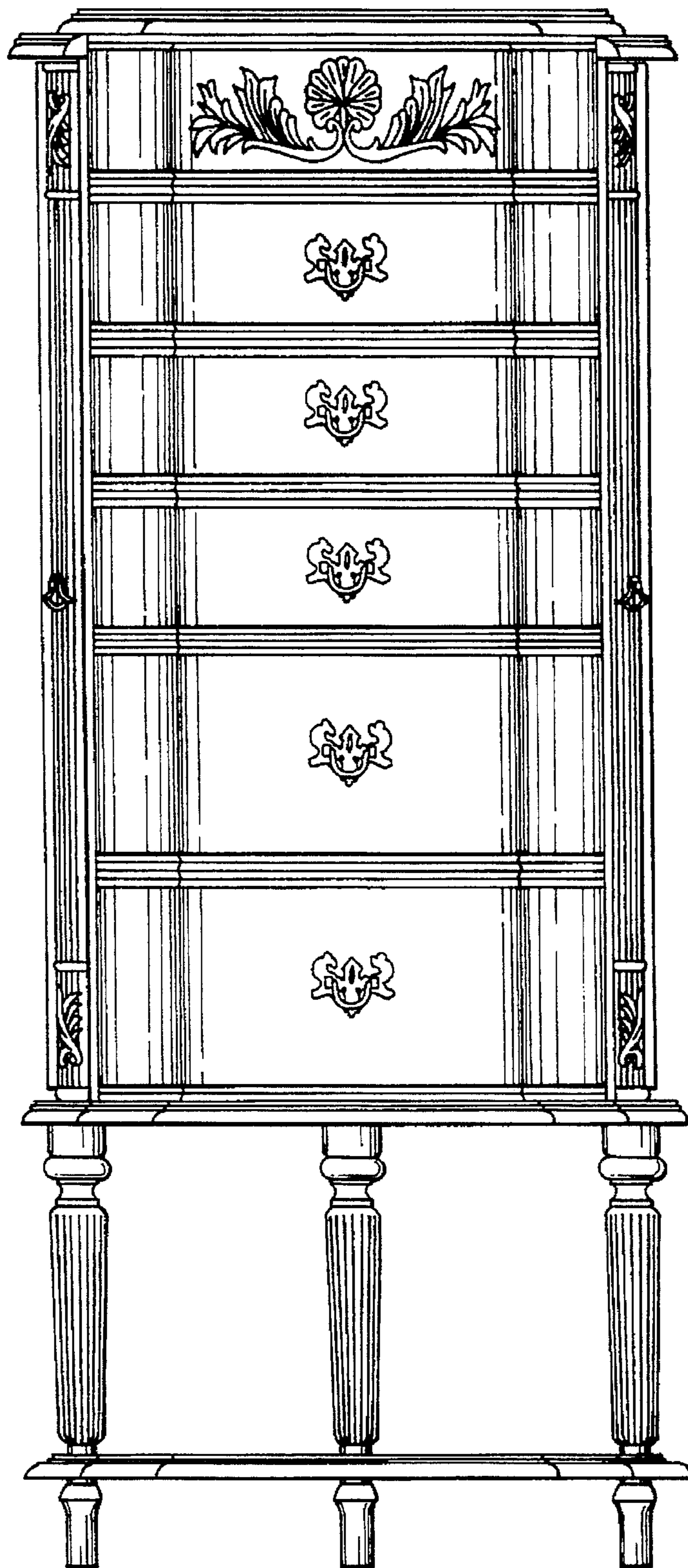

FIG. 2

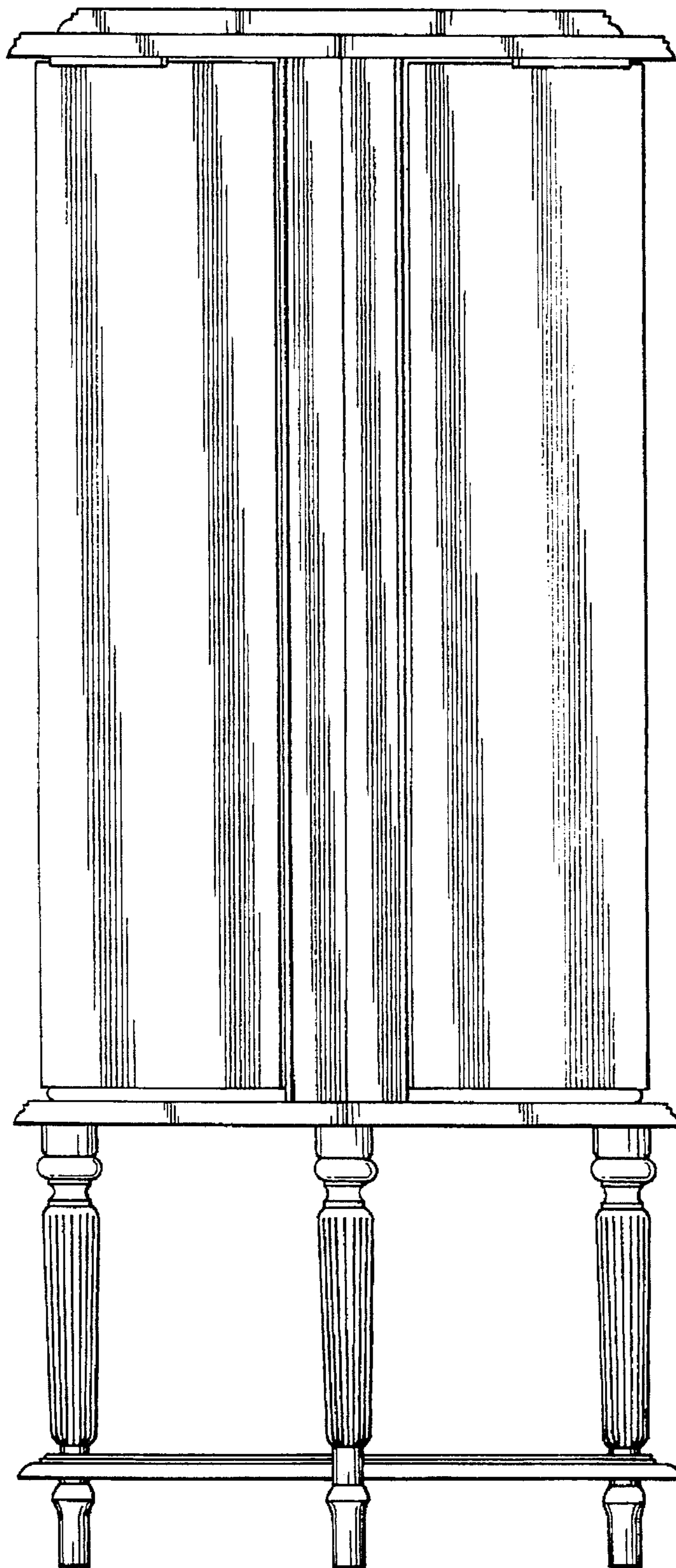

FIG. 3

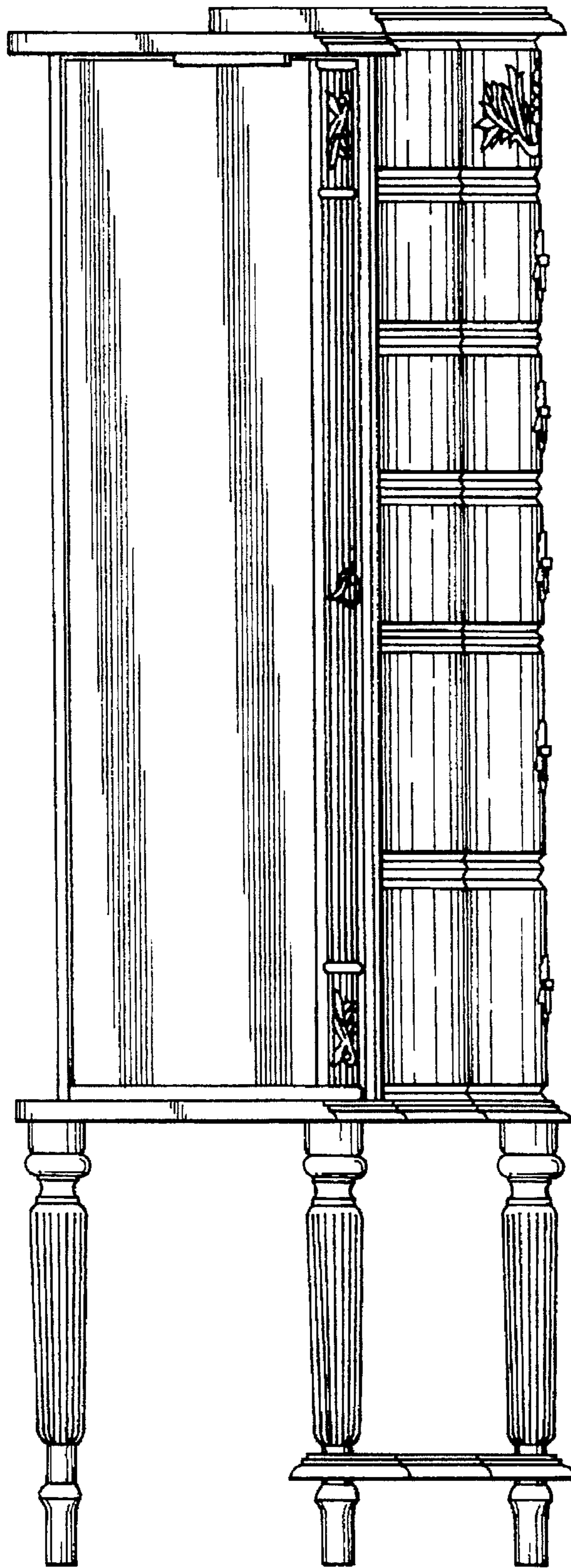

FIG.4

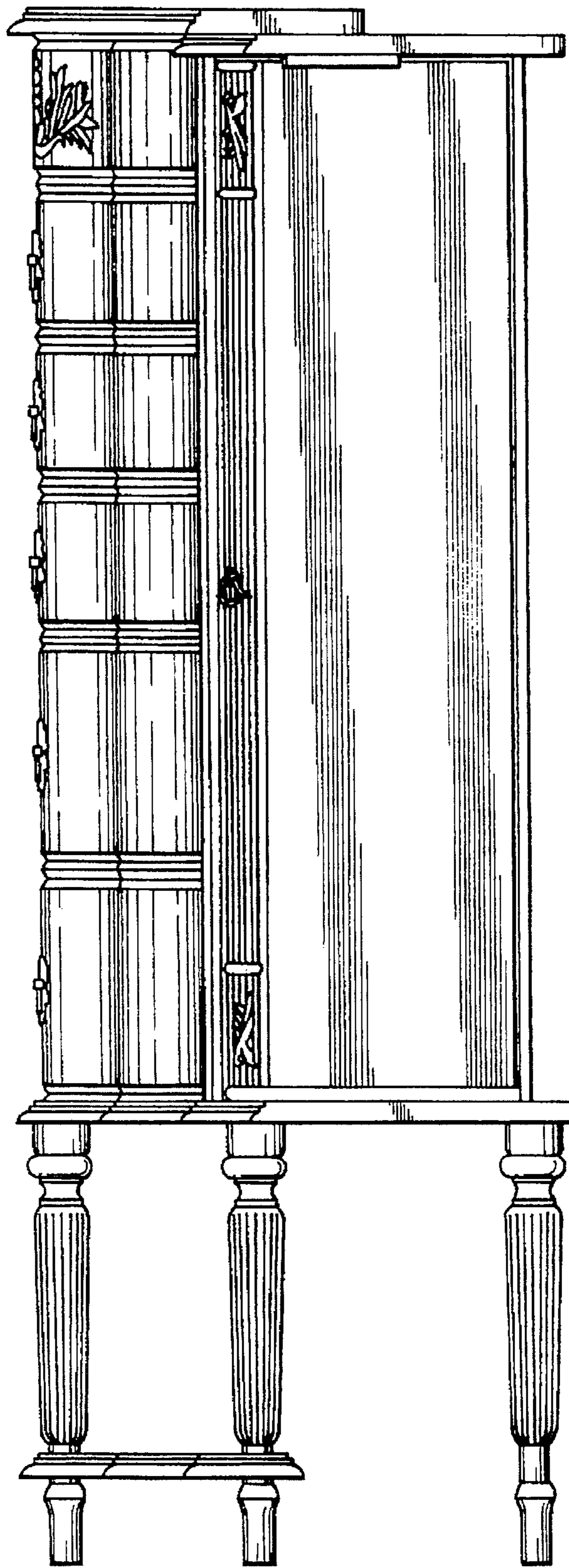

FIG. 5

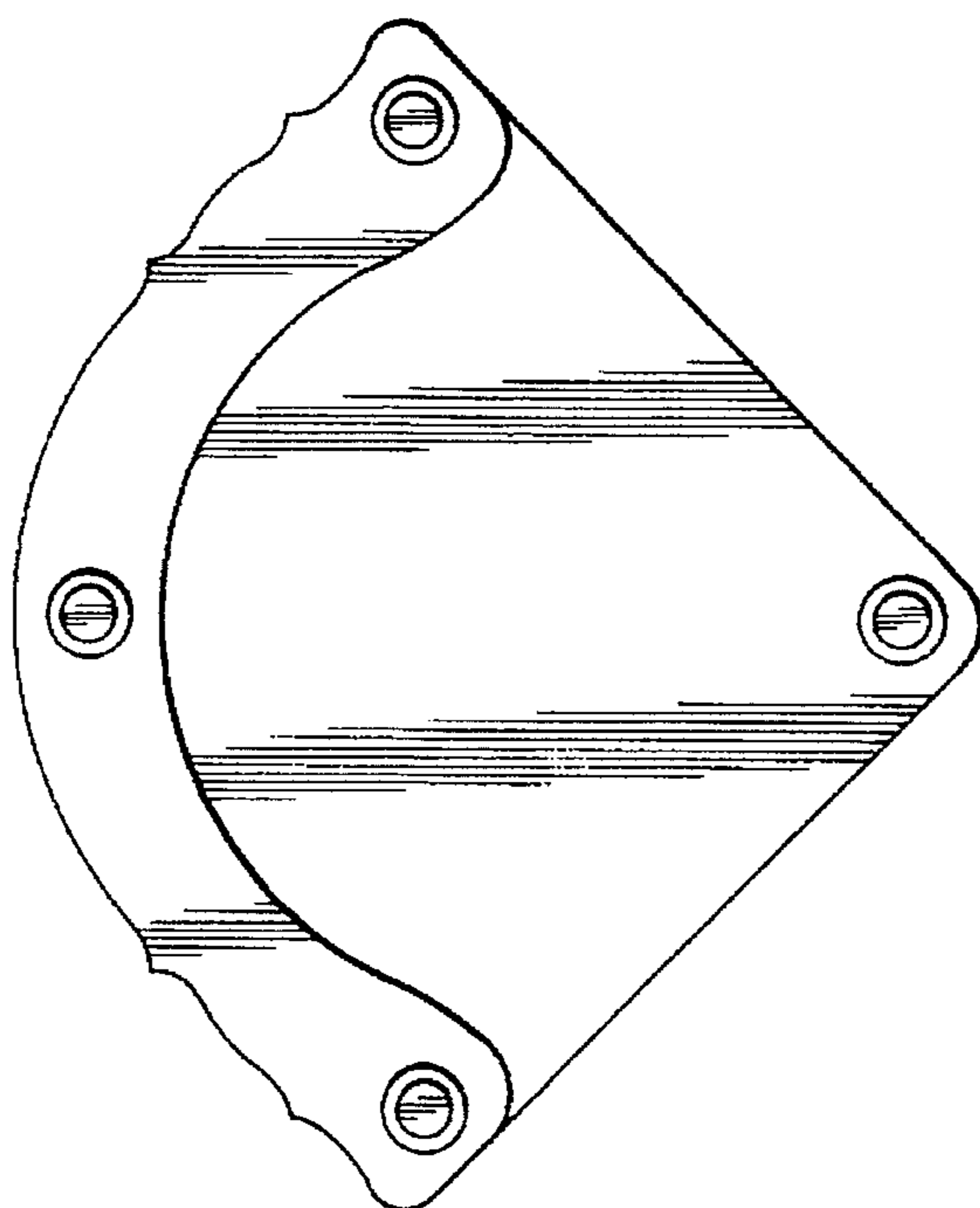

FIG. 7

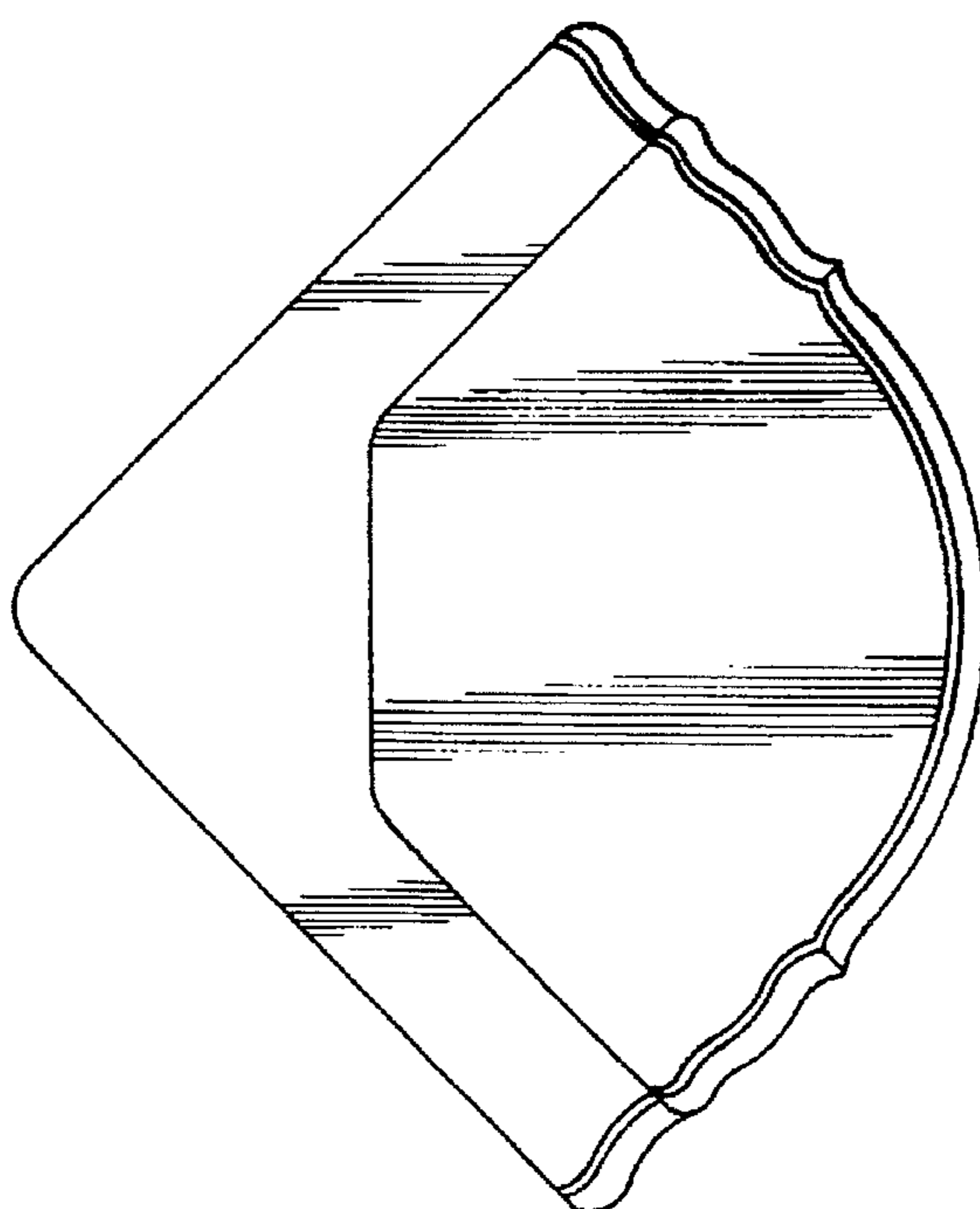

FIG. 6