



US00D380515S

United States Patent [19]

[11] Patent Number: **Des. 380,515**

Fabbri, Jr. et al.

[45] Date of Patent: ****Jul. 1, 1997**

[54] **GOLF PUTTER HEAD**

5,377,541 1/1995 Patten 73/379.02
5,419,563 5/1995 Abrams et al. 273/187.5

[75] Inventors: **Remo Fabbri, Jr.**, 32 Trumbull St.,
New Haven, Conn. 06511; **Mark R. Schmitt**, Tipp City, Ohio

Primary Examiner—Terry A. Wallace
Assistant Examiner—Mitchell I. Siegel

[73] Assignee: **Remo Fabbri, Jr.**, Cape May, N.J.

[57] **CLAIM**

[**] Term: **14 Years**

The ornamental design for a golf putter head, as shown and described.

[21] Appl. No.: **50,355**

DESCRIPTION

[22] Filed: **Feb. 15, 1996**

FIG. 1 is a perspective view of a golf putter head having a top portion, two sides, a front, a back and a bottom portion showing my new design;

[51] LOC (6) Cl. **21-02**

[52] U.S. Cl. **D21/219**

FIG. 2 is an enlarged top plan view thereof;

[58] Field of Search **D21/217-219;**

FIG. 3 is a side elevational view of FIG. 2;

473/340, 341, 251-256

FIG. 4 is another side elevational view of FIG. 2;

FIG. 5 is a front view of FIG. 2;

FIG. 6 is a bottom view of FIG. 2;

FIG. 7 is a back view of FIG. 2;

FIG. 8 is a perspective view of an alternate embodiment of a golf putter head having a top portion, two sides, a front, a back and a bottom portion, showing my design;

FIG. 9 is an enlarged top plan view of FIG. 8;

FIG. 10 is a side elevational view of FIG. 9;

FIG. 11 is another side elevational view of FIG. 9;

FIG. 12 is a front view of FIG. 9;

FIG. 13 is a bottom view of FIG. 9; and,

FIG. 14 is a back view of FIG. 9.

The broken line showing of a shaft is for illustrative purposes only and forms no part of the claimed design.

[56] **References Cited**

U.S. PATENT DOCUMENTS

D. 149,156	3/1948	Weatherington	D21/219
2,558,805	7/1951	Yaglou	73/172
2,954,231	9/1960	MacIntyre	D21/219 X
2,957,696	10/1960	Warotas	D21/219 X
3,323,367	6/1967	Searle	73/379
3,897,058	7/1975	Koch	273/26 B
3,954,271	5/1976	Tredway	273/186 A
4,103,896	8/1978	Lorang	273/183 D
4,138,118	2/1979	Budney	273/183 D
4,861,034	8/1989	Lee	273/183 D
4,930,785	6/1990	Mills	273/183 D
5,322,289	6/1994	Abrams et al.	273/187.5
5,372,365	12/1994	McTeigue et al.	273/187.2

1 Claim, 4 Drawing Sheets

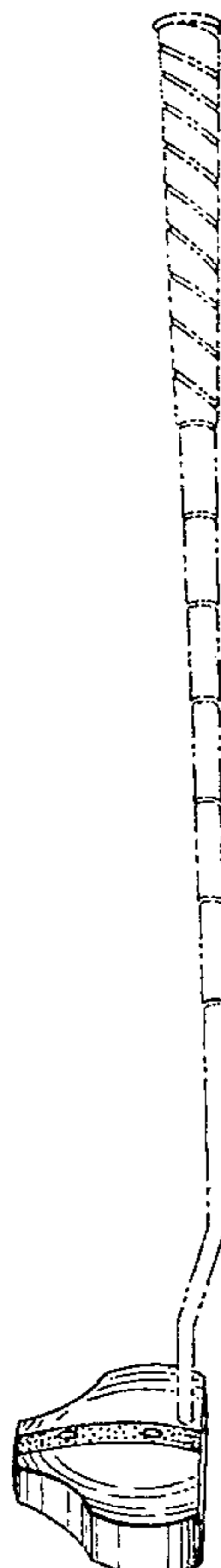

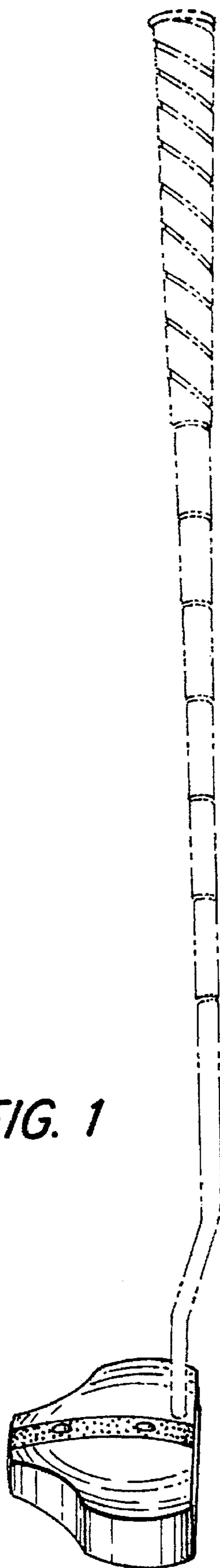

FIG. 1

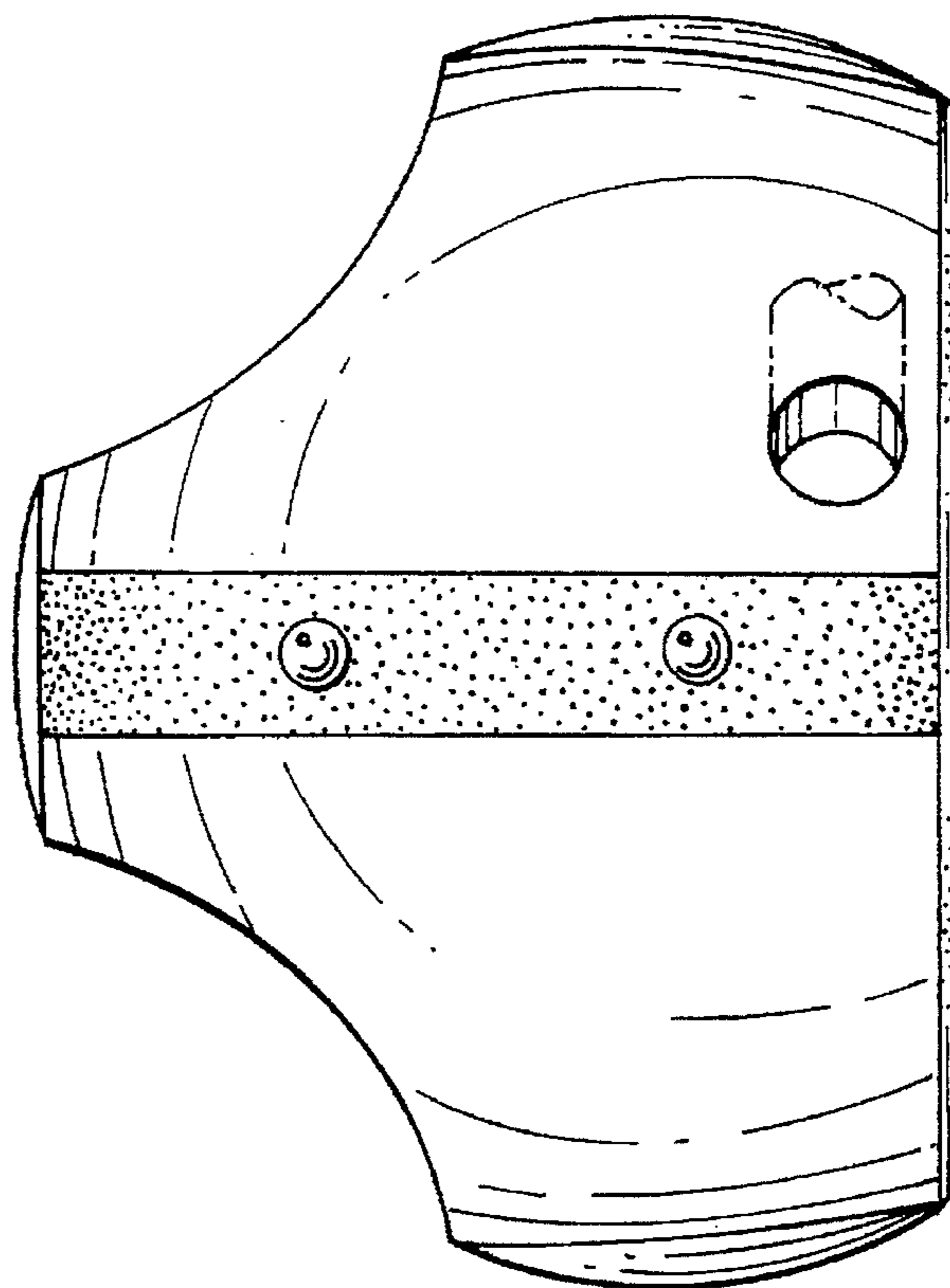

FIG. 2

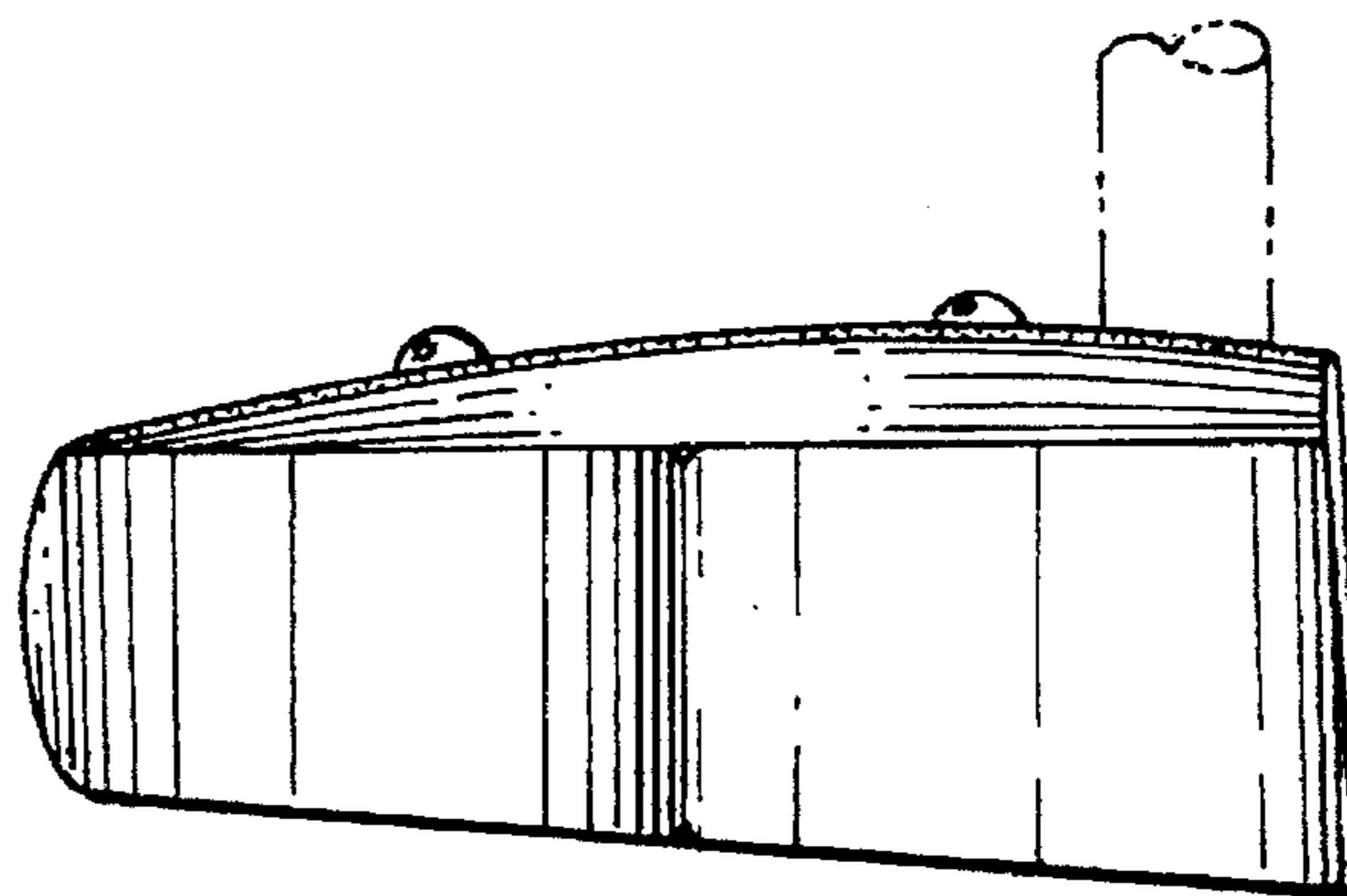

FIG. 3

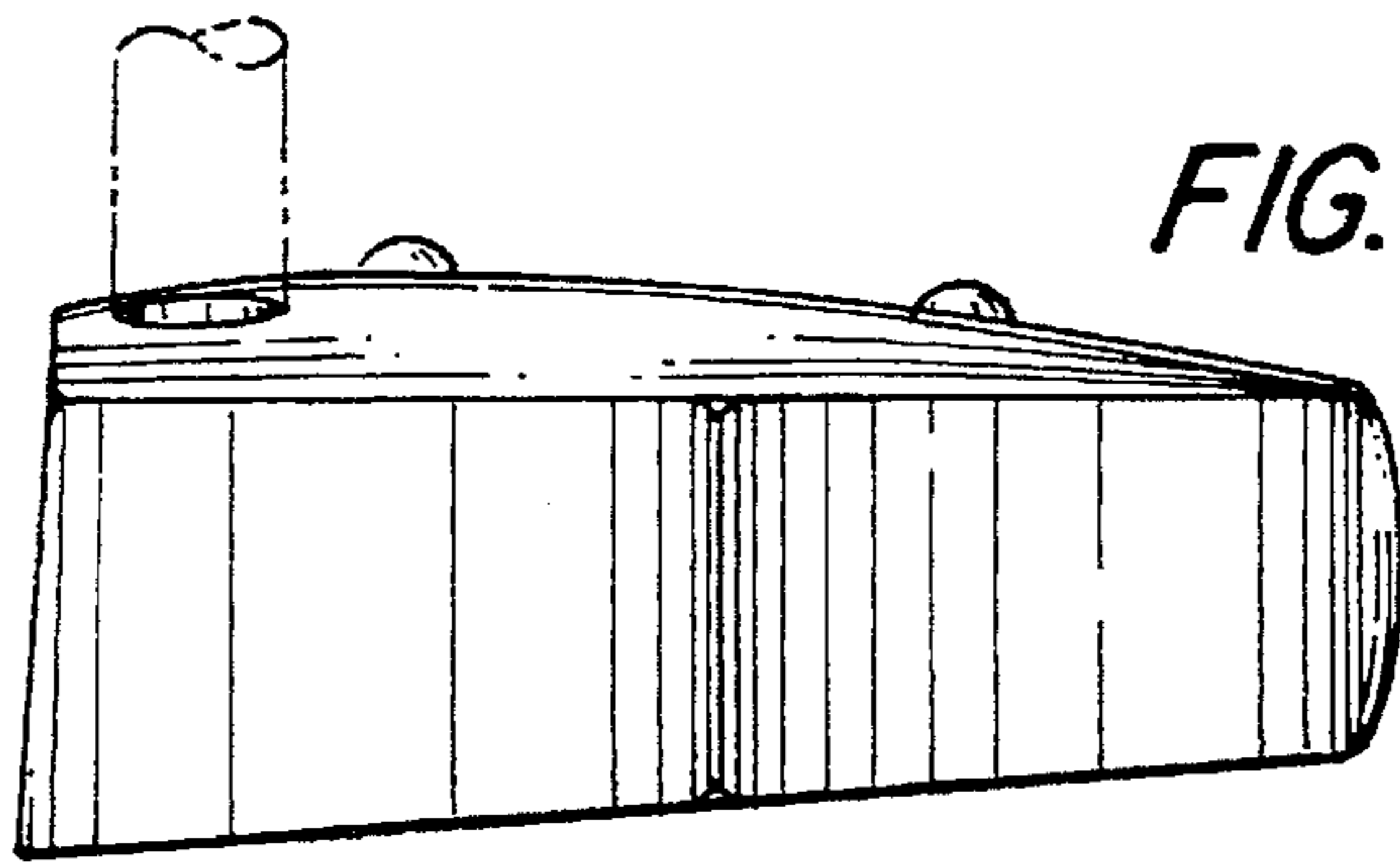

FIG. 4

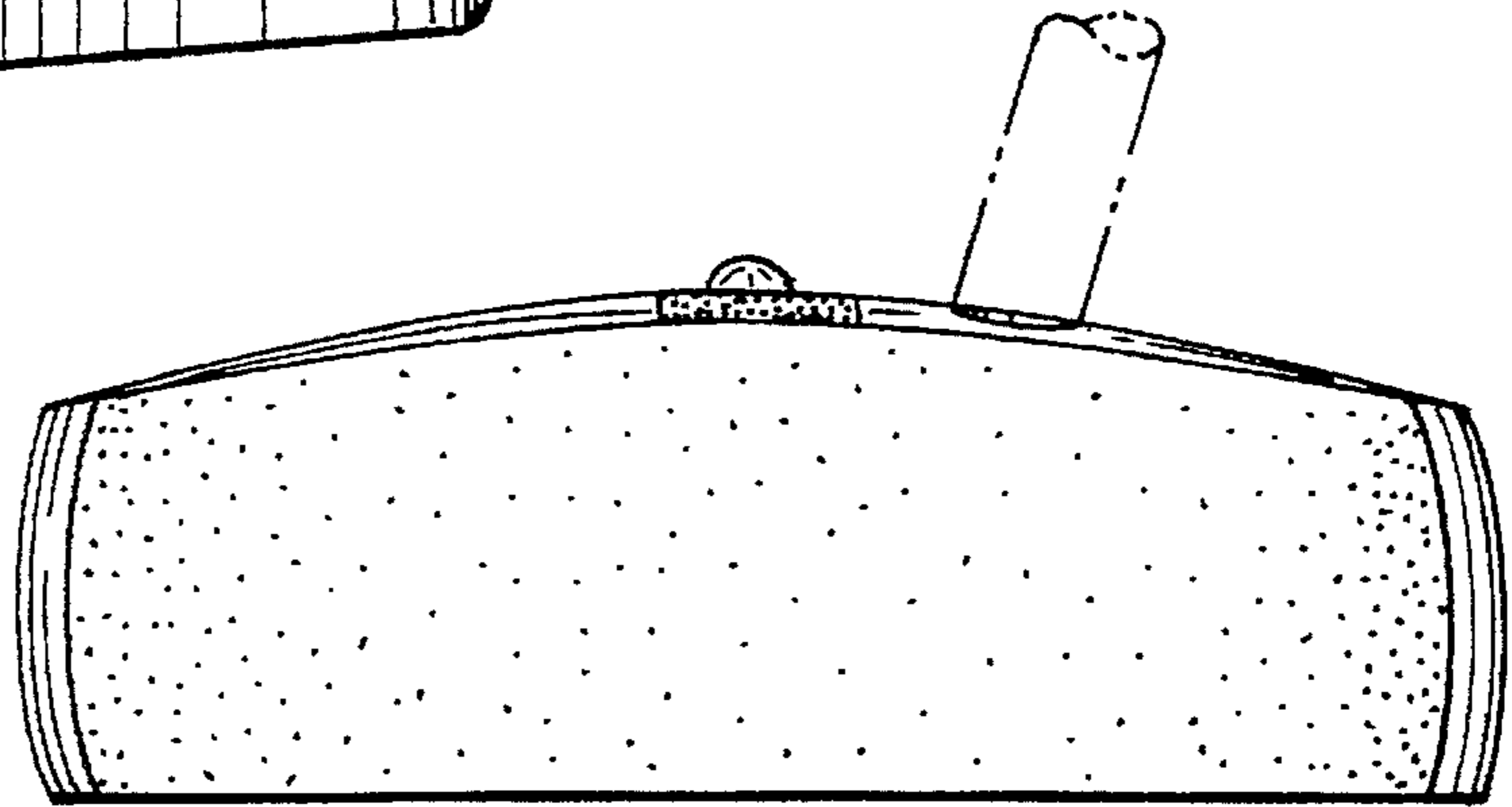
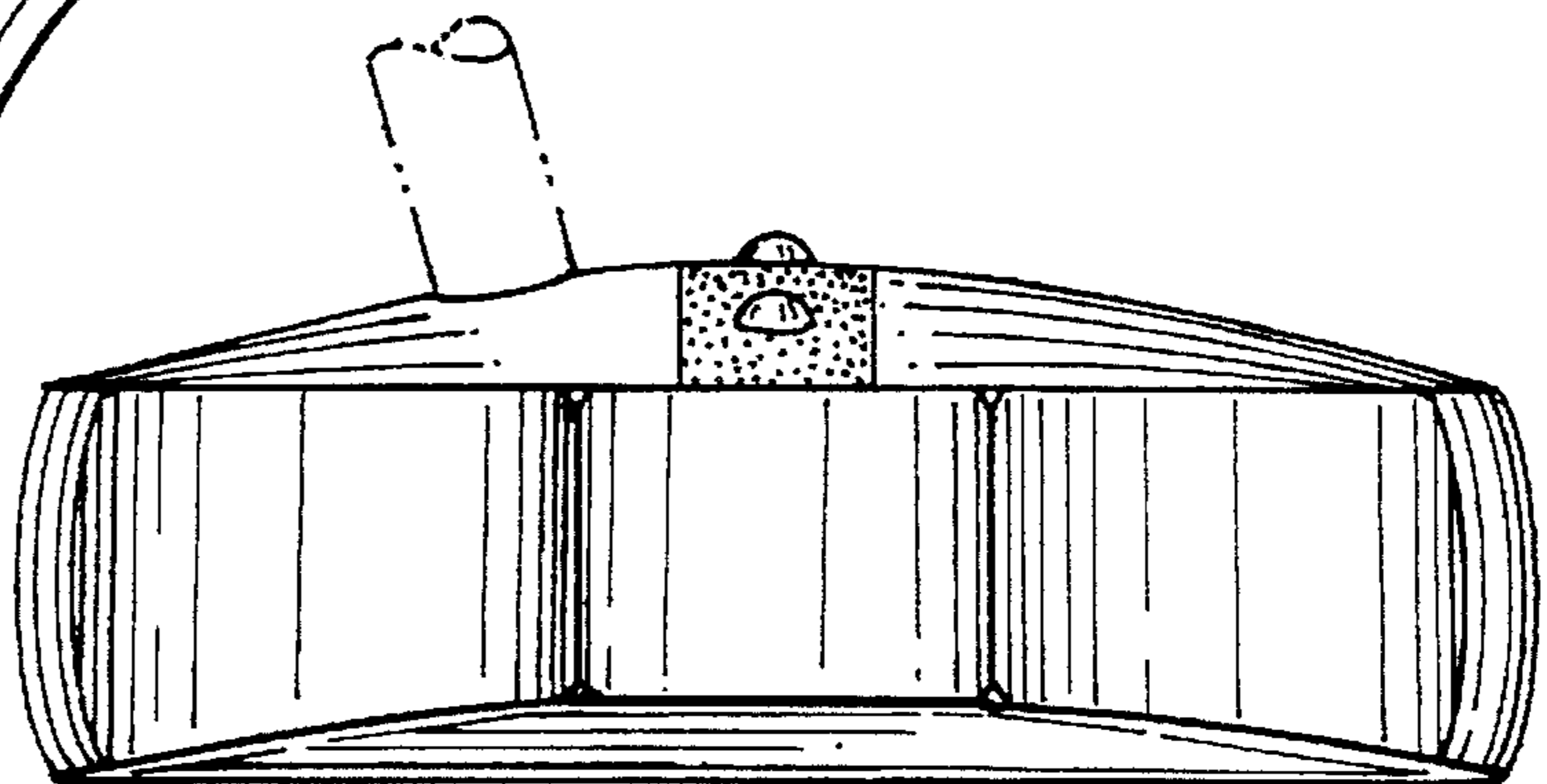

FIG. 5



FIG. 6

FIG. 7



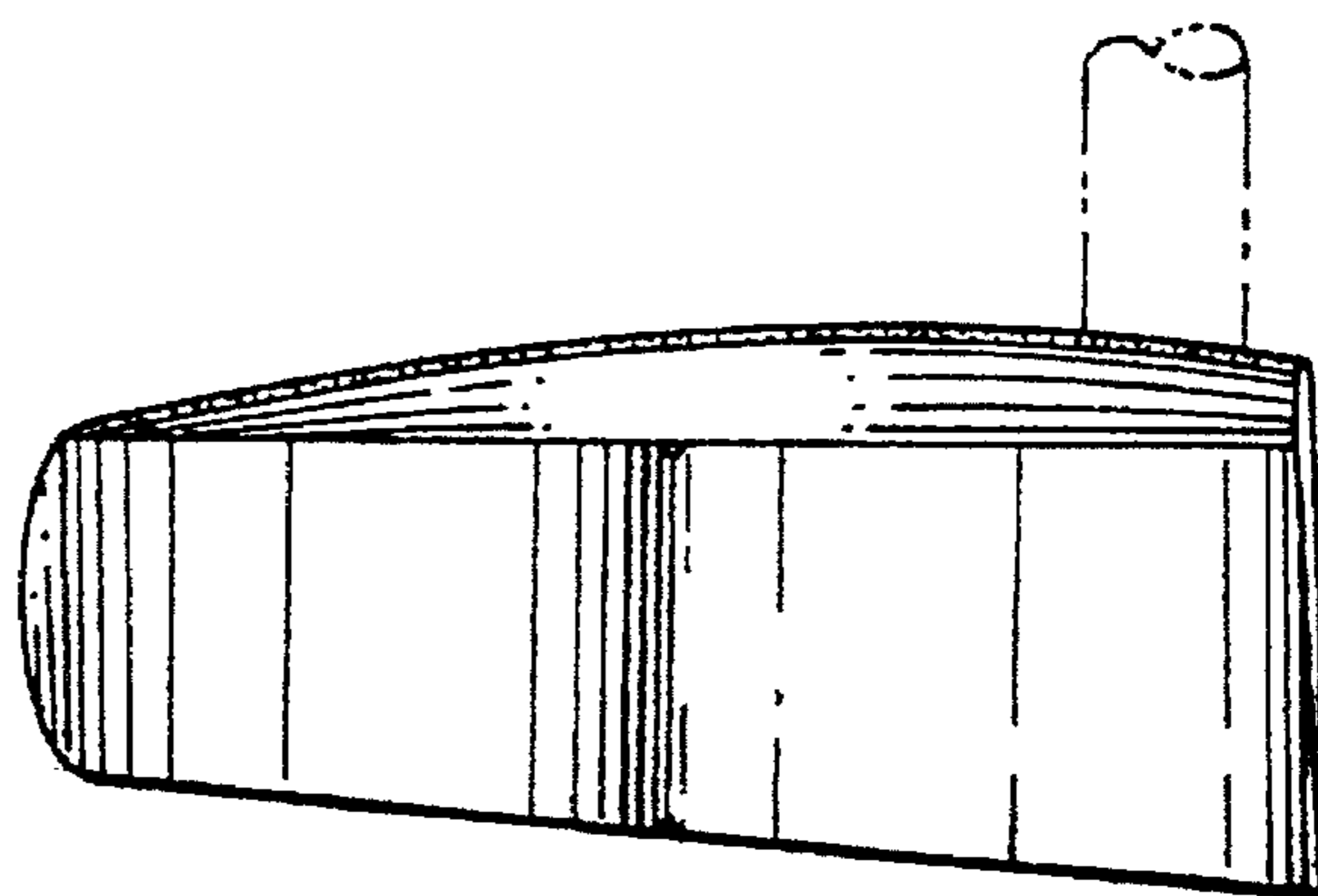
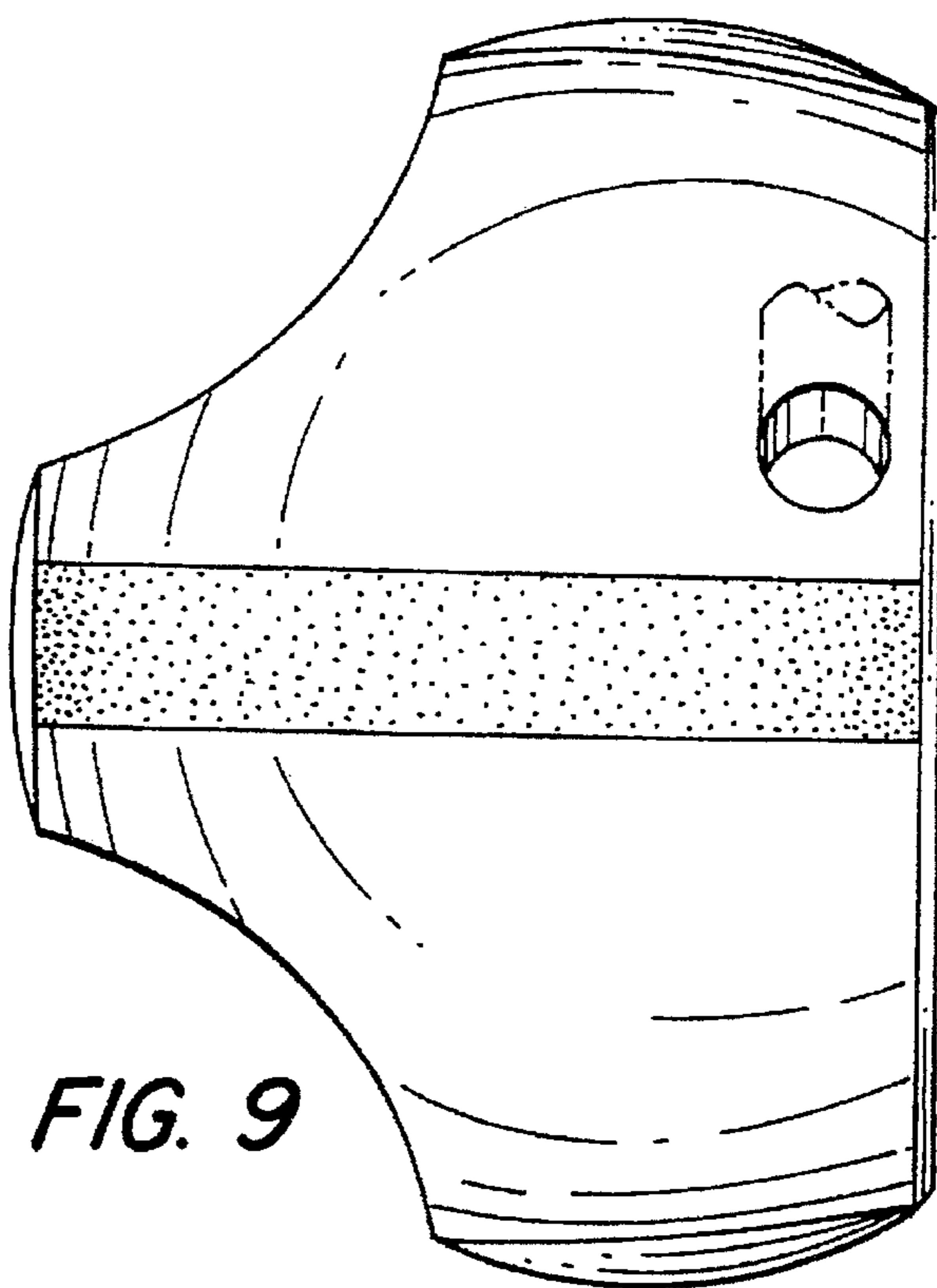
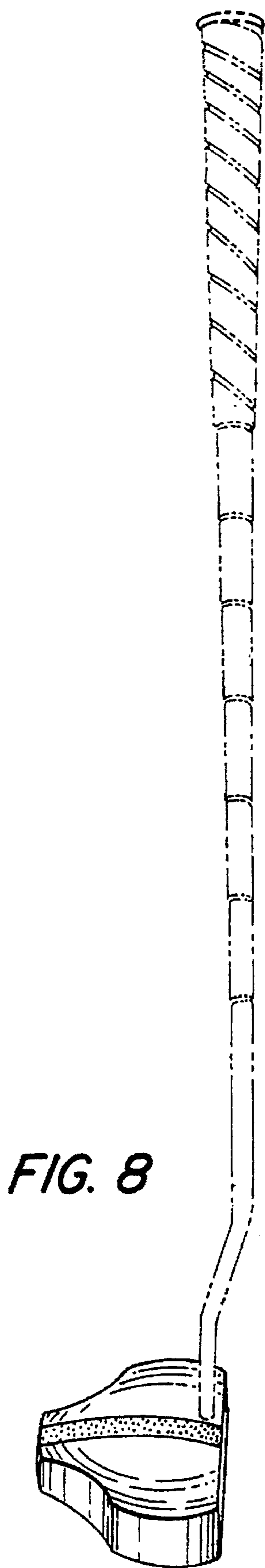

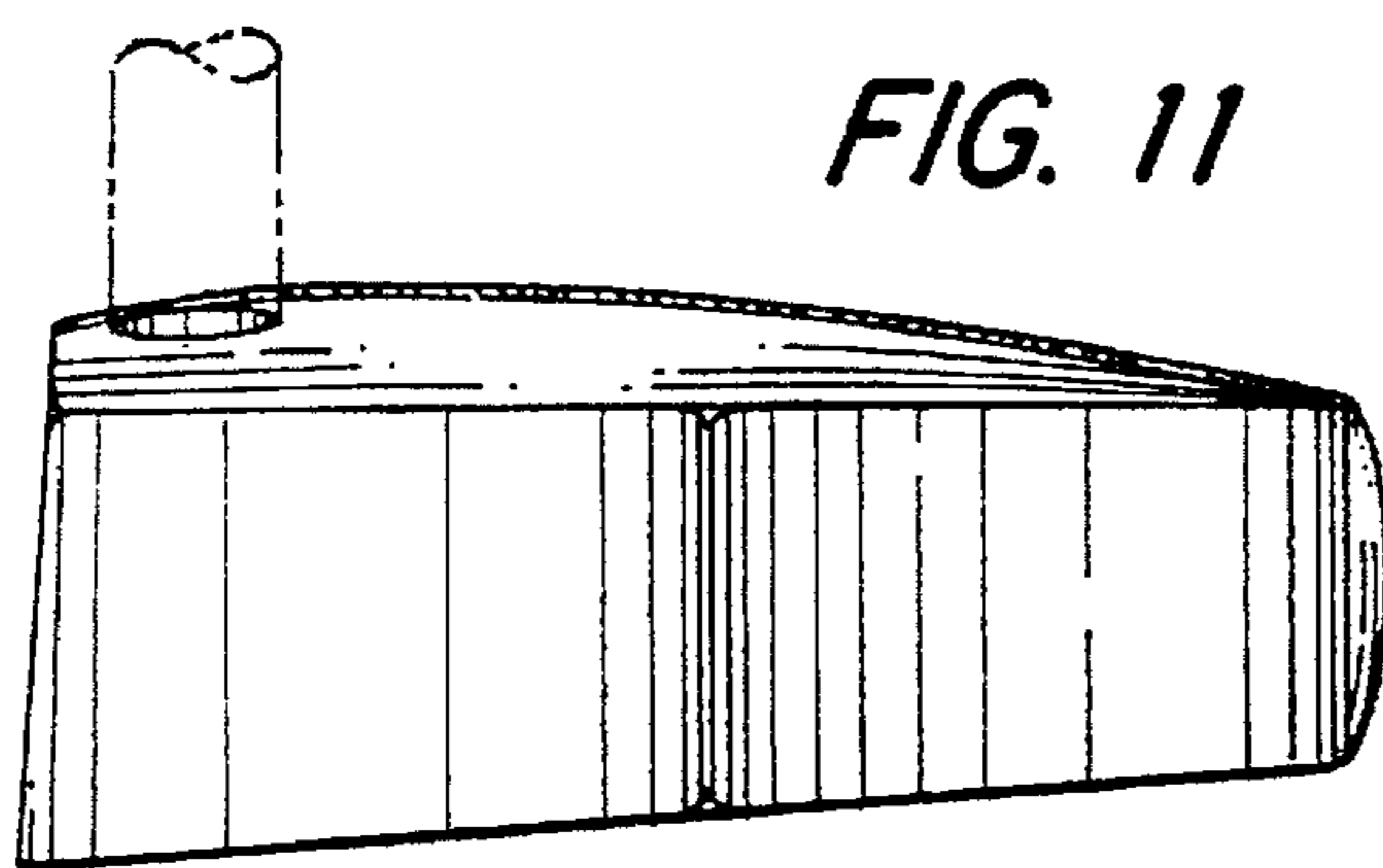

FIG. 11

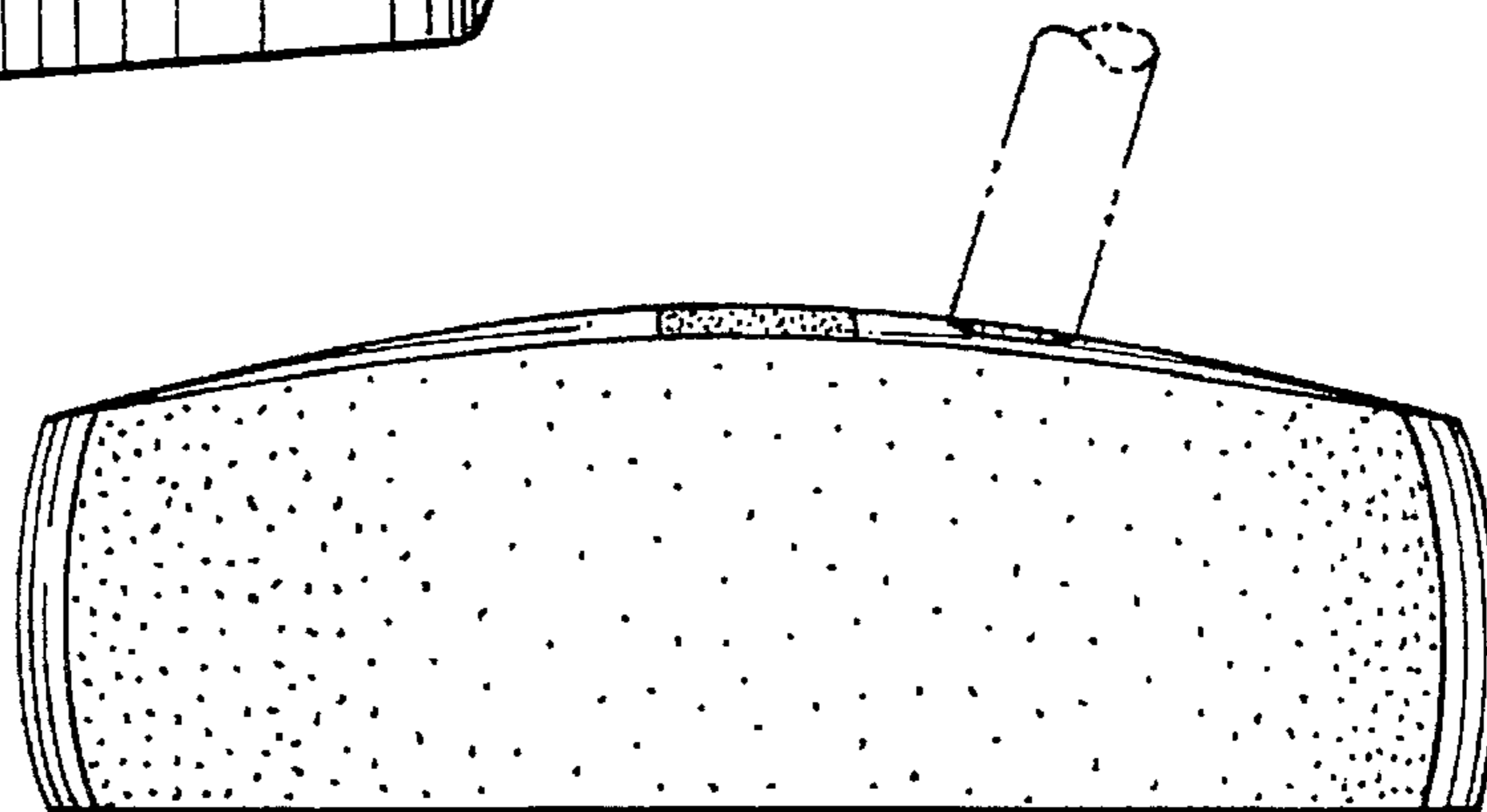

FIG. 12

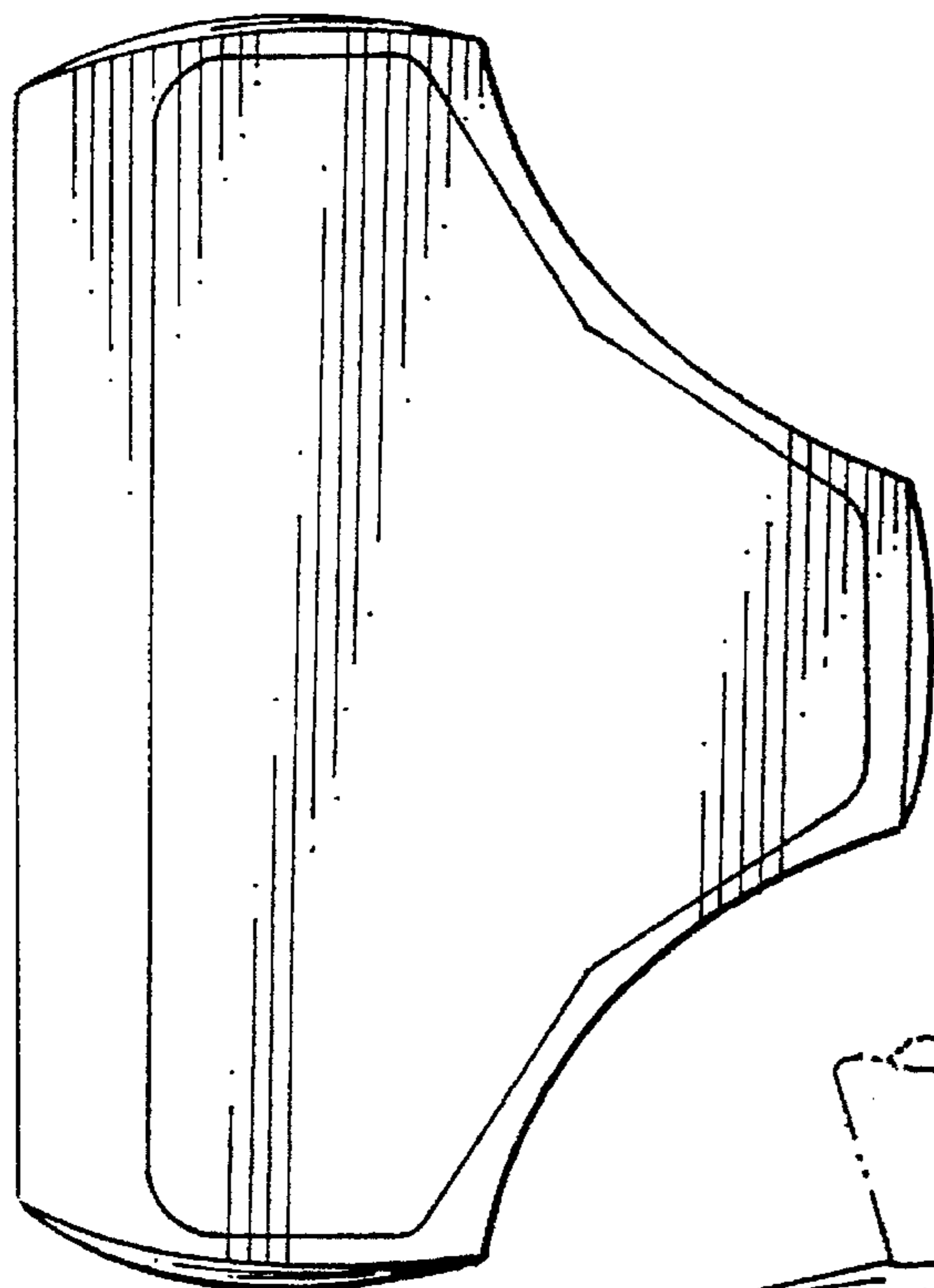

FIG. 13

FIG. 14

