



US00D380491S

# United States Patent [19]

Tashiro et al.

[11] Patent Number: **Des. 380,491**

[45] Date of Patent: **\*\*\*Jul. 1, 1997**

[54] **INK CARTRIDGE FOR PRINTER**

[75] Inventors: **Naoki Tashiro, Kawasaki; Toshihiko Ujita, Yamato; Teruo Arashima, Kawasaki; Yuji Hamasaki, Sagami-hara; Hisashi Yamamoto, Hiratsuka; Wataru Takahashi, Yokohama, all of Japan**

[73] Assignee: **Canon Kabushiki Kaisha, Tokyo, Japan**

[\*] Notice: The portion of the term of this patent subsequent to Dec. 31, 2010, has been disclaimed.

[\*\*] Term: **14 Years**

[21] Appl. No.: **42,263**

[22] Filed: **Aug. 4, 1995**

[30] **Foreign Application Priority Data**

Feb. 6, 1995 [JP] Japan ..... 7-2795

[51] LOC (6) Cl. .... **18-02**

[52] U.S. Cl. .... **D18/56**

[58] Field of Search ..... D18/12, 43, 56;  
347/42-43, 86-87

[56] **References Cited**

**U.S. PATENT DOCUMENTS**

D. 325,743	4/1992	Kojima et al. ....	D18/56
D. 326,111	5/1992	Otsuka et al. ....	D18/56
D. 331,939	12/1992	Ujita .....	D18/12
D. 338,224	8/1993	Ujita .....	D18/56
D. 338,232	8/1993	Kotaki et al. ....	D18/56
D. 341,619	11/1993	Ujita et al. ....	D18/56
D. 341,620	11/1993	Ujita et al. ....	D18/56
D. 348,477	7/1994	Ujita et al. ....	D18/56
D. 348,478	7/1994	Ujita et al. ....	D18/56
D. 348,479	7/1994	Ujita et al. ....	D18/56

D. 348,480	7/1994	Ujita et al. ....	D18/56
D. 348,688	7/1994	Ujita .....	D18/12
D. 349,723	8/1994	Ujita .....	D18/12
D. 351,855	10/1994	Kubota et al. ....	D18/56
D. 351,856	10/1994	Watanabe et al. ....	D18/56
D. 352,059	11/1994	Kubota et al. ....	D18/56
D. 352,060	11/1994	Kubota et al. ....	D18/56
D. 355,210	2/1995	Kubota et al. ....	D18/56
D. 355,213	2/1995	Kubota et al. ....	D18/56
D. 355,215	2/1995	Kubota et al. ....	D18/56
D. 355,929	2/1995	Kubota et al. ....	D18/56
D. 356,332	3/1995	Kubota et al. ....	D18/56
D. 363,736	10/1995	Ujita et al. ....	D18/56
D. 367,884	3/1996	Taneya et al. ....	D18/56

**FOREIGN PATENT DOCUMENTS**

523635	1/1993	European Pat. Off. ....	347/86
4369557	12/1992	Japan .....	D18/56

**OTHER PUBLICATIONS**

Canon brochure; Replaceable BJ Cartridge; Rear Cover.

*Primary Examiner*—Cathy Anne MacCormac  
*Attorney, Agent, or Firm*—Fitzpatrick, Cella, Harper & Scinto

[57] **CLAIM**

The ornamental design for an ink cartridge for printer, as shown and described.

**DESCRIPTION**

FIG. 1 is a front elevational view of an ink cartridge for printer, showing our new design;  
FIG. 2 is a rear elevational view thereof;  
FIG. 3 is a top plan view thereof;  
FIG. 4 is a bottom plan view thereof;  
FIG. 5 is a left side elevational view thereof;  
FIG. 6 is a right side elevational view thereof; and,  
FIG. 7 is a perspective view thereof.

**1 Claim, 1 Drawing Sheet**

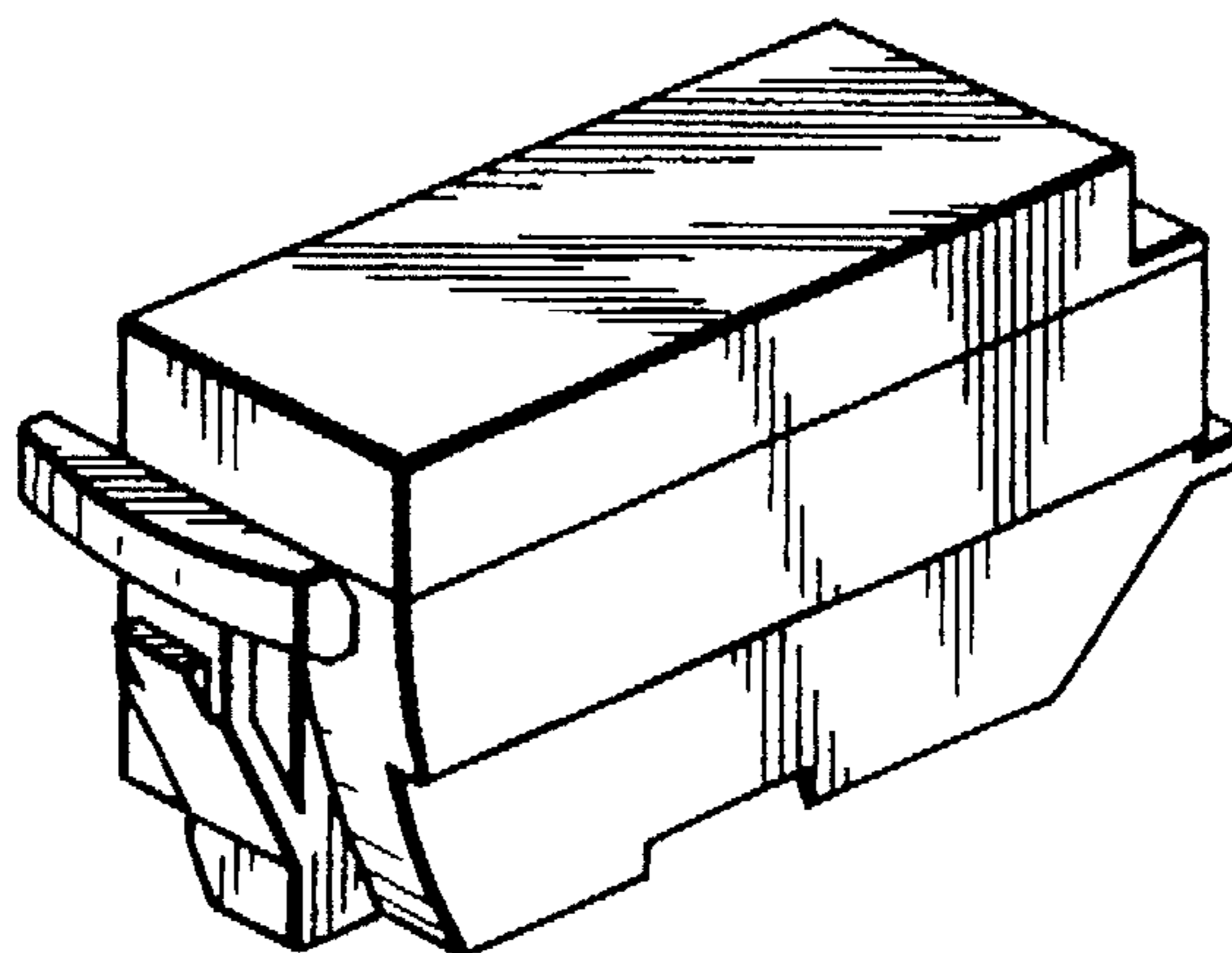

FIG. 1

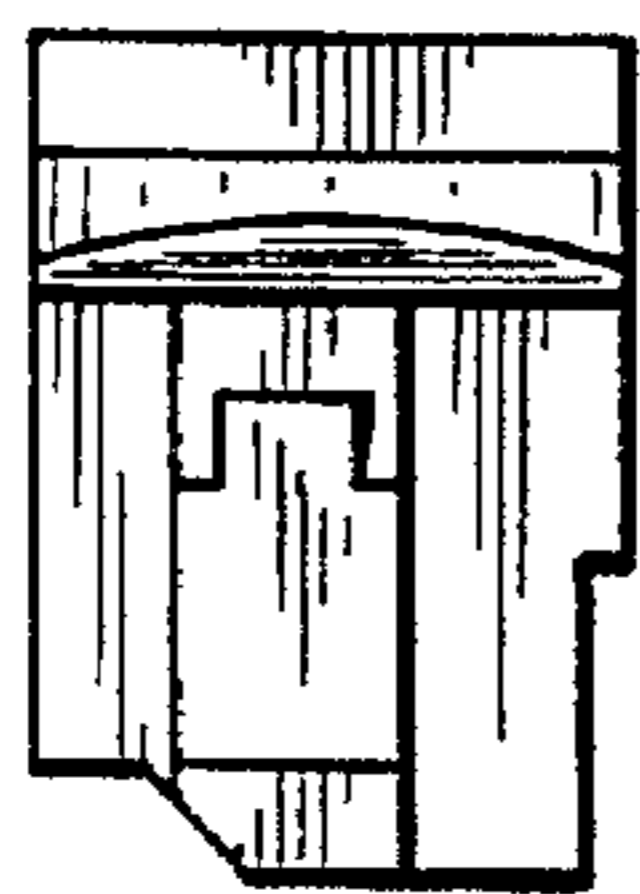

FIG. 2

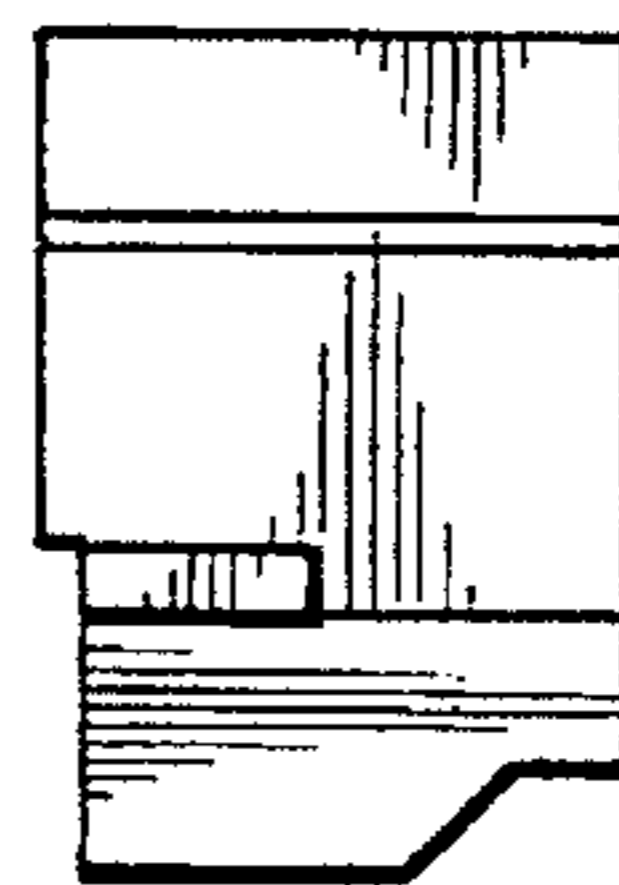

FIG. 3

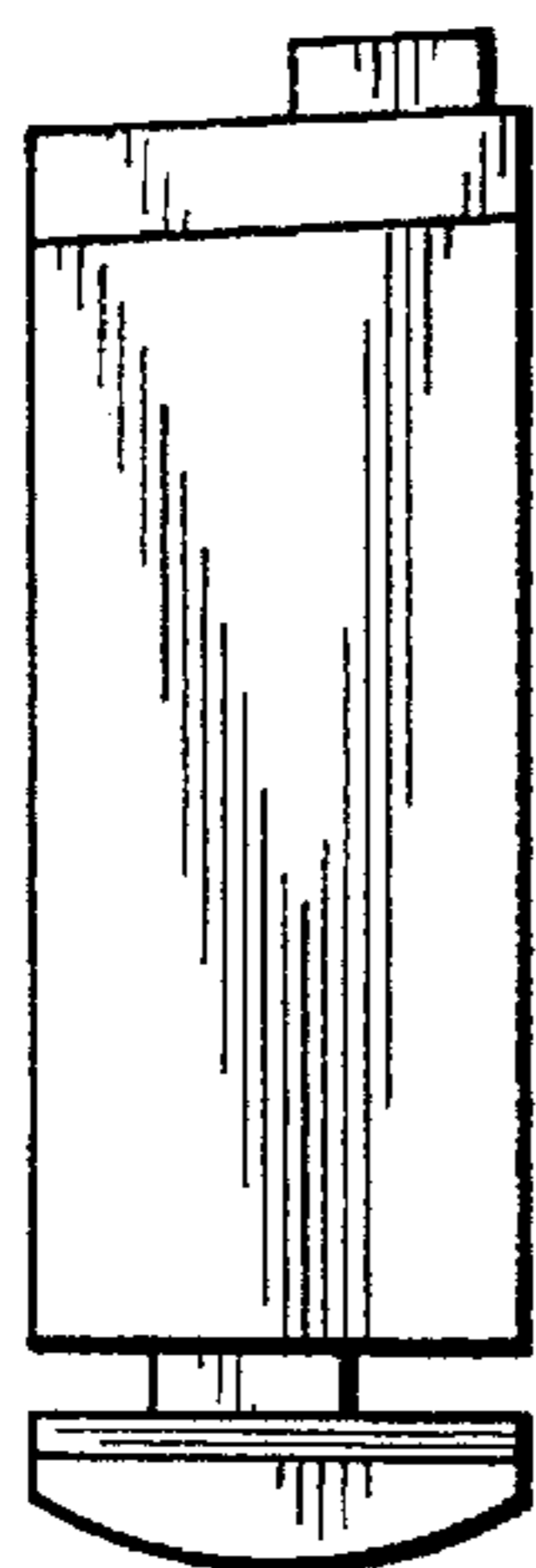

FIG. 4

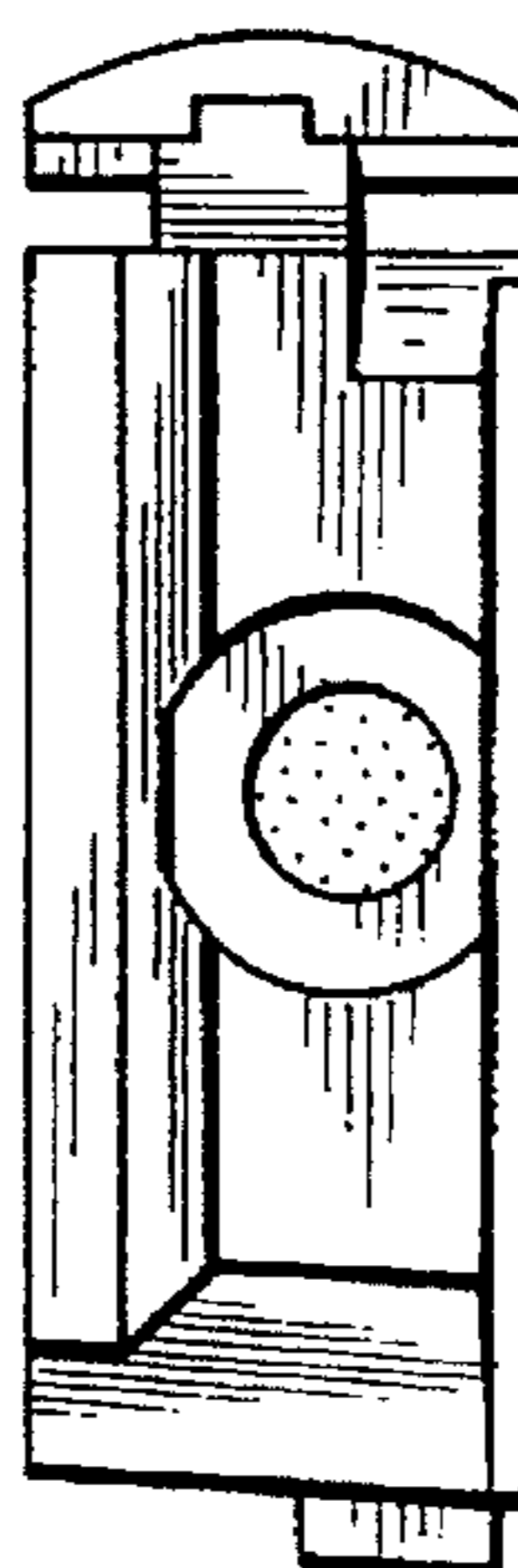

FIG. 5

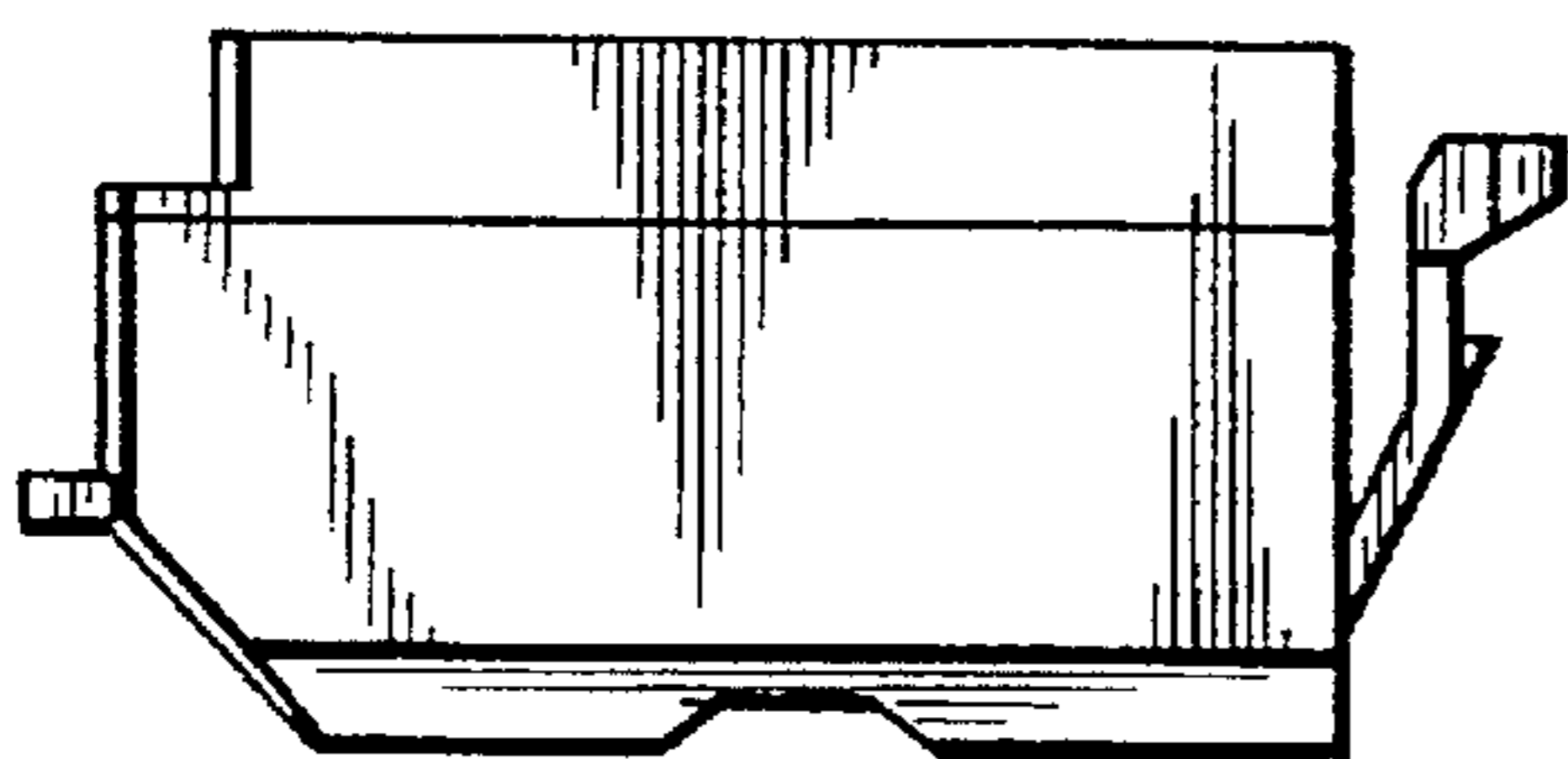

FIG. 6

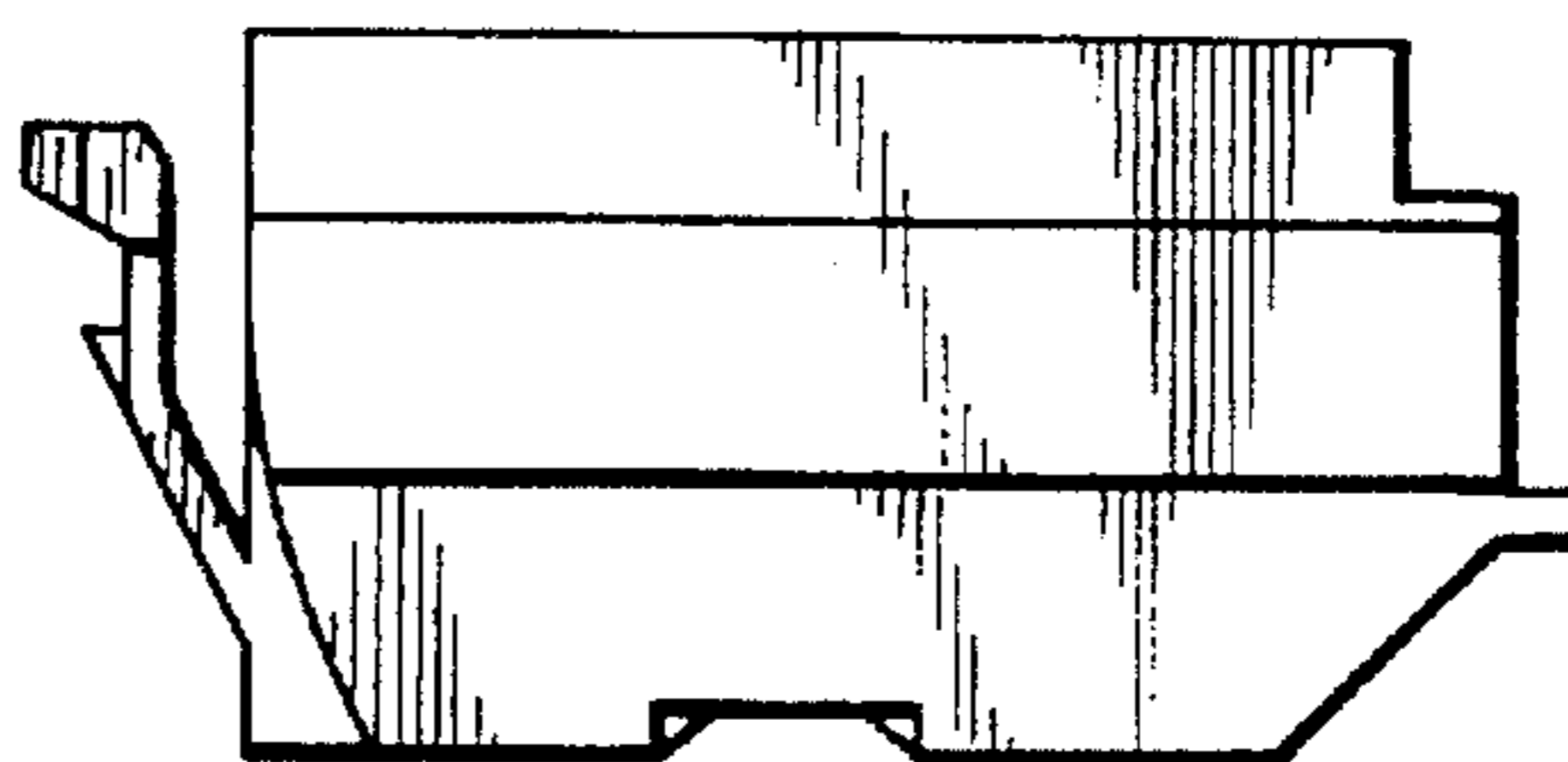

FIG. 7

