



US00D380407S

# United States Patent [19]

Weder et al.

[11] Patent Number: **Des. 380,407**

[45] Date of Patent: **\*\*Jul. 1, 1997**

## [54] FLOWER POT COVER

[75] Inventors: **Donald E. Weder; Joseph G. Straeter**, both of Highland, Ill.

[73] Assignee: **Southpac Trust International, Inc.**, Oklahoma City, Okla.

[\*\*] Term: **14 Years**

[21] Appl. No.: **45,384**

[22] Filed: **Oct. 18, 1995**

### Related U.S. Application Data

[60] Division of Ser. No. 673, Oct. 20, 1992, Pat. No. Des. 364,116, which is a continuation-in-part of Ser. No. 781,453, Oct. 21, 1991, Pat. No. Des. 348,634, which is a continuation-in-part of Ser. No. 617,454, Nov. 21, 1990, abandoned, Ser. No. 411,249, Sep. 22, 1989, Pat. No. Des. 358,113, Ser. No. 411,247, Sep. 22, 1989, abandoned, and Ser. No. 411,245, Sep. 22, 1989, abandoned.

[51] LOC (6) Cl. .... **11-02**

[52] U.S. Cl. .... **D11/164**

[58] Field of Search ..... D11/143, 149, D11/152-156, 164, 89, 90; 47/66, 72; 206/423; 215/100.5; 229/1.5 R, 1.5 B, 4.5, 108, 108.1, 109, 110, 87.01, 922, 930, 186, 189; 428/27, 35.1, 24, 542.6; 338/122; D9/346, 428-431; D27/102, 133; D26/128-136; D19/96; D7/540, 584, 586, 587, 354

### [56] References Cited

#### U.S. PATENT DOCUMENTS

D. 239,192	3/1976	Wiles et al. ....	D35/3 A
D. 254,659	4/1980	Karotseris .....	D11/143
D. 289,024	3/1987	Vaughn .....	D11/164
D. 292,182	10/1987	Weder et al. ....	D11/164
D. 293,224	12/1987	Weder et al. ....	D11/164
D. 293,774	1/1988	Weder et al. ....	D11/164
D. 315,878	4/1991	Weder et al. ....	D11/164
D. 315,879	4/1991	Weder et al. ....	D11/164
D. 318,030	7/1991	Weder et al. ....	D11/164
D. 318,635	7/1991	Weder et al. ....	D11/164
D. 322,403	12/1991	Eaton .....	D9/429
D. 324,659	3/1992	Stehouwer .....	D11/164
D. 336,041	6/1993	Zama .....	D9/429

D. 348,634	7/1994	Weder et al. ....	D11/164
D. 359,931	7/1995	Weder et al. ....	D11/164
D. 364,116	11/1995	Weder et al. ....	D11/164
D. 364,119	11/1995	Weder et al. ....	D11/164
D. 364,585	11/1995	Weder et al. ....	D11/164
1,924,926	8/1933	Gray .....	65/53
1,951,642	3/1934	Augustin et al. ....	47/34
3,253,768	5/1966	Gjesdal .....	229/37
3,443,741	5/1969	Stockdale .....	229/51
4,043,077	8/1977	Stonehocker .....	47/66
4,216,620	8/1980	Weder et al. ....	47/72
4,300,312	11/1981	Weder et al. ....	47/72
4,712,725	12/1987	Moore .....	229/8
4,733,521	3/1988	Weder et al. ....	53/580
5,076,011	12/1991	Stehouwer .....	47/72

### FOREIGN PATENT DOCUMENTS

2489126	3/1982	France .
2603159	4/1988	France .

### OTHER PUBLICATIONS

Exhibit A —“The Simple Solution For Those Peak Volume Periods”, (5 pages) a brochure published by Highland Supply Corporation, 1111 Sixth St., Highland, Illinois 62249, ©1989.

Exhibit B —“The Glass of Frederick Carder”, ©1971 by P. V. Gardner, showing various styles of glass basket-like vases or containers.

*Primary Examiner*—Jeffrey Asch  
*Attorney, Agent, or Firm*—Dunlap & Coddling, P.C.

### [57] CLAIM

The ornamental design for a flower pot cover, as shown and described.

### DESCRIPTION

FIG. 1 is a perspective view of our new flower pot cover design;

FIG. 2 is a side elevational view thereof;

FIG. 3 is a top plan view thereof;

FIG. 4 is a bottom plan view thereof;

FIG. 5 is a side elevational view of the design of FIG. 1, the only difference being in the horizontal angle of the skirt;

FIG. 6 is a side elevational view of the design of FIG. 1, the only difference being in the near vertical angle of the skirt;

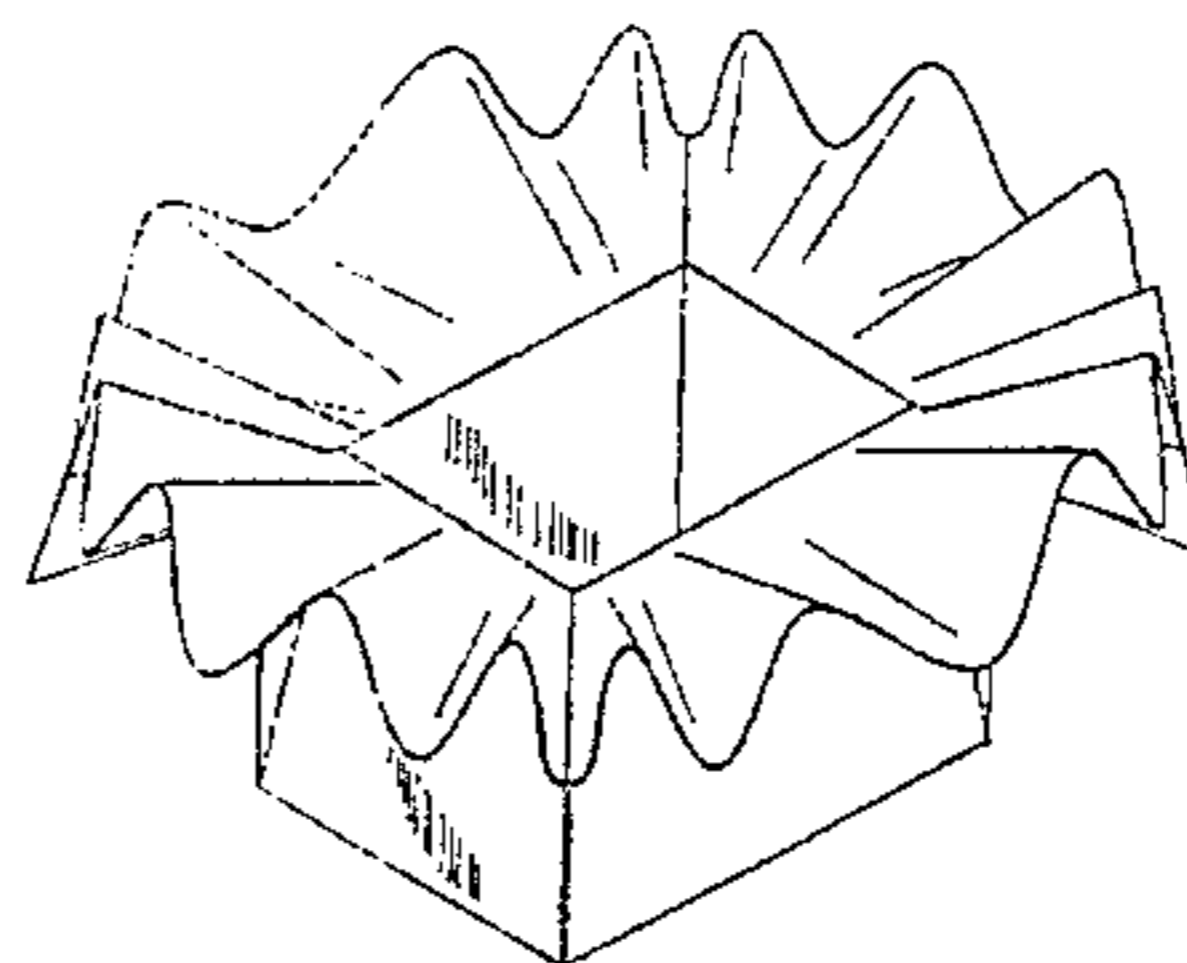
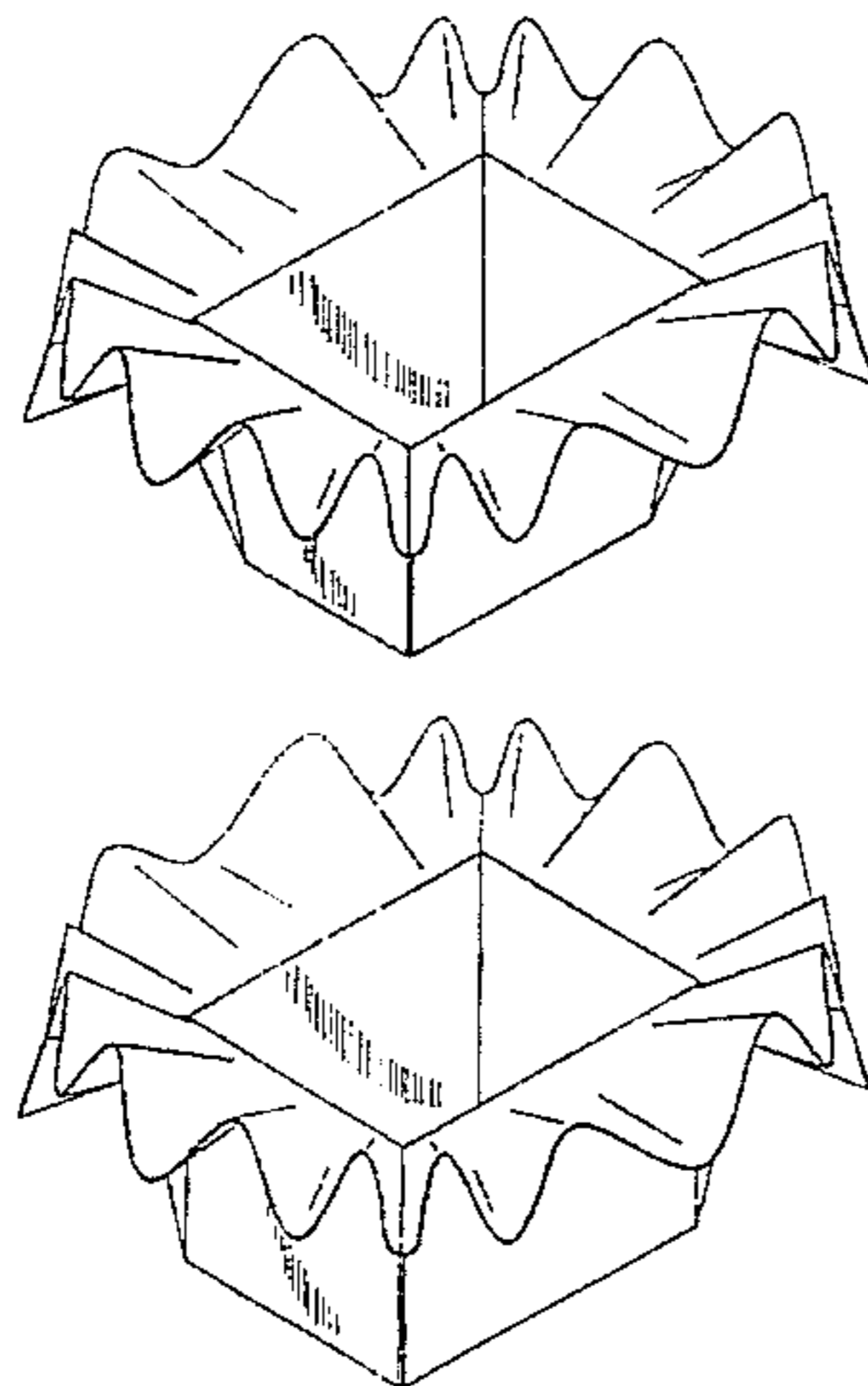

FIG. 7 is a side elevational view of the design of FIG. 1, the only difference being in the downward angle of the skirt;  
FIG. 8 is a side elevational view of a second embodiment of the design of FIG. 1, the only difference being in the height of the base;

FIG. 9 is a side elevational view of a third embodiment of the design of FIG. 1, the only difference being in the height of the base;

FIG. 10 is a side elevational view of a fourth embodiment of the design of FIG. 1, the only difference being in the size of the skirt;

FIG. 11 is a side elevational view of a fifth embodiment of the design of FIG. 1, the only difference being in the size of the skirt;

FIG. 12 is a perspective view of a sixth embodiment of our new flower pot cover design;

FIG. 13 is a side elevational view thereof;

FIG. 14 is a top plan view thereof;

FIG. 15 is a bottom plan view thereof;

FIG. 16 is a side elevational view of the design of FIG. 12, the only difference being in the horizontal angle of the skirt;

FIG. 17 is a side elevational view of the design of FIG. 12, the only difference being in the near vertical angle of the skirt;

FIG. 18 is a side elevational view of the design of FIG. 12, the only difference being in the downward angle of the skirt;

FIG. 19 is a side elevational view of a seventh embodiment of the flower pot cover design, the only difference over FIG. 12 being in the height of the base;

FIG. 20 is a side elevational view of an eighth embodiment of the flower pot cover design, the only difference over FIG. 12 being in the height of the base;

FIG. 21 is a side elevational view of a ninth embodiment of the flower pot cover design, the only difference over FIG. 12 being in the size of the skirt;

FIG. 22 is a side elevational view of a tenth embodiment of the flower pot cover design, the only difference over FIG. 12 being in the size of the skirt;

FIG. 23 is a perspective view of an eleventh embodiment of our new flower pot cover design;

FIG. 24 is a side elevational view thereof;

FIG. 25 is a top plan view thereof;

FIG. 26 is a bottom plan view thereof;

FIG. 27 is a side elevational view of the design of FIG. 23, the only difference being in the horizontal angle of the skirt;

FIG. 28 is a side elevational view of the design of FIG. 23, the only difference being in the near vertical angle of the skirt;

FIG. 29 is a side elevational view of the design of FIG. 23, the only difference being in the downward angle of the skirt;

FIG. 30 is a side elevational view of a twelfth embodiment of the flower pot cover design, the only difference over FIG. 23 being in the height of the base;

FIG. 31 is a side elevational view of a thirteenth embodiment of the flower pot cover design, the only difference over FIG. 23 being in the height of the base.

FIG. 32 is a side elevational view of a fourteenth embodiment of the flower pot cover design, the only difference over FIG. 23 being in the size of the skirt; and,

FIG. 33 is a side elevational view of a fifteenth embodiment of the flower pot cover design, the only difference over FIG. 23 being in the size of the skirt.

**1 Claim, 6 Drawing Sheets**

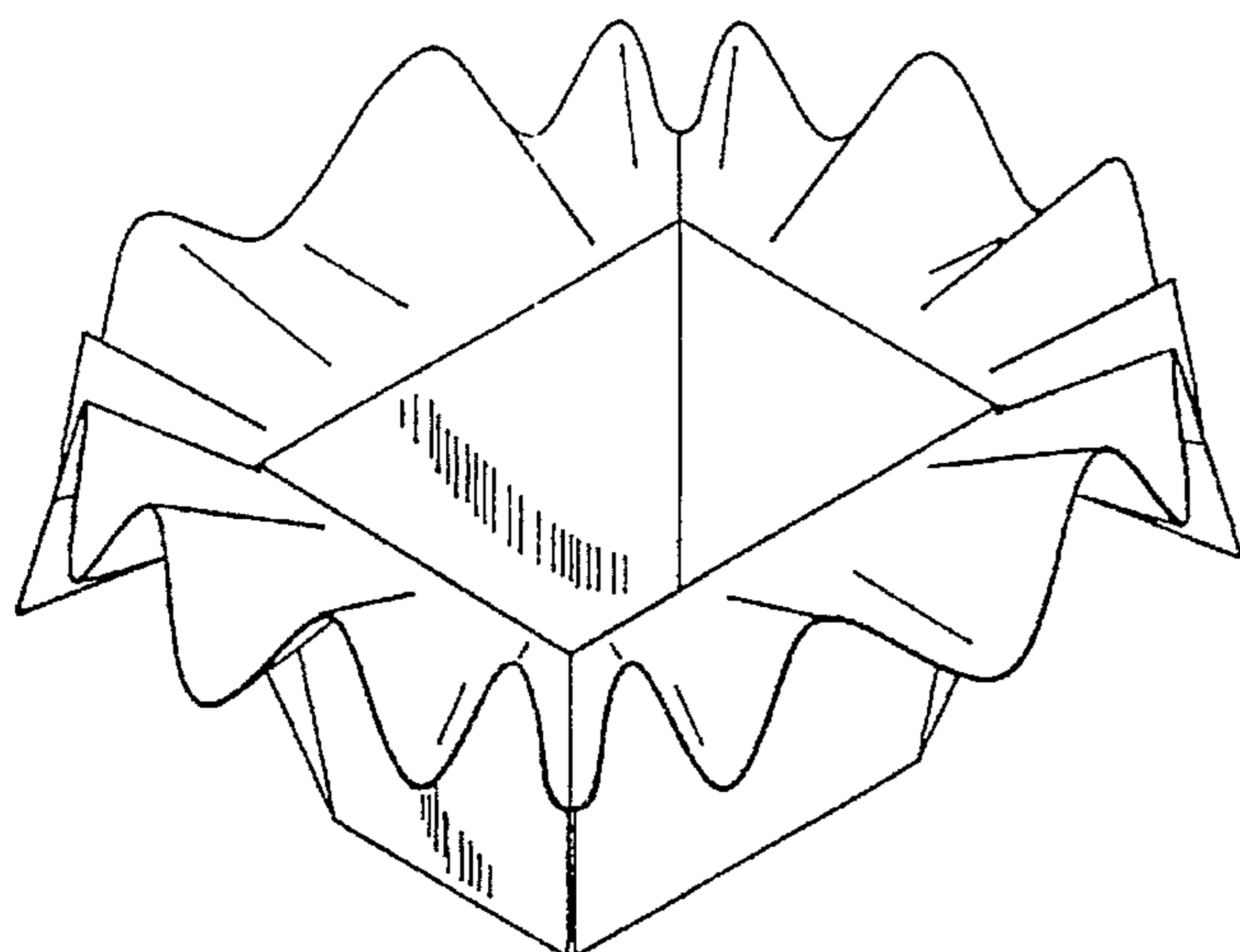

FIG. 1

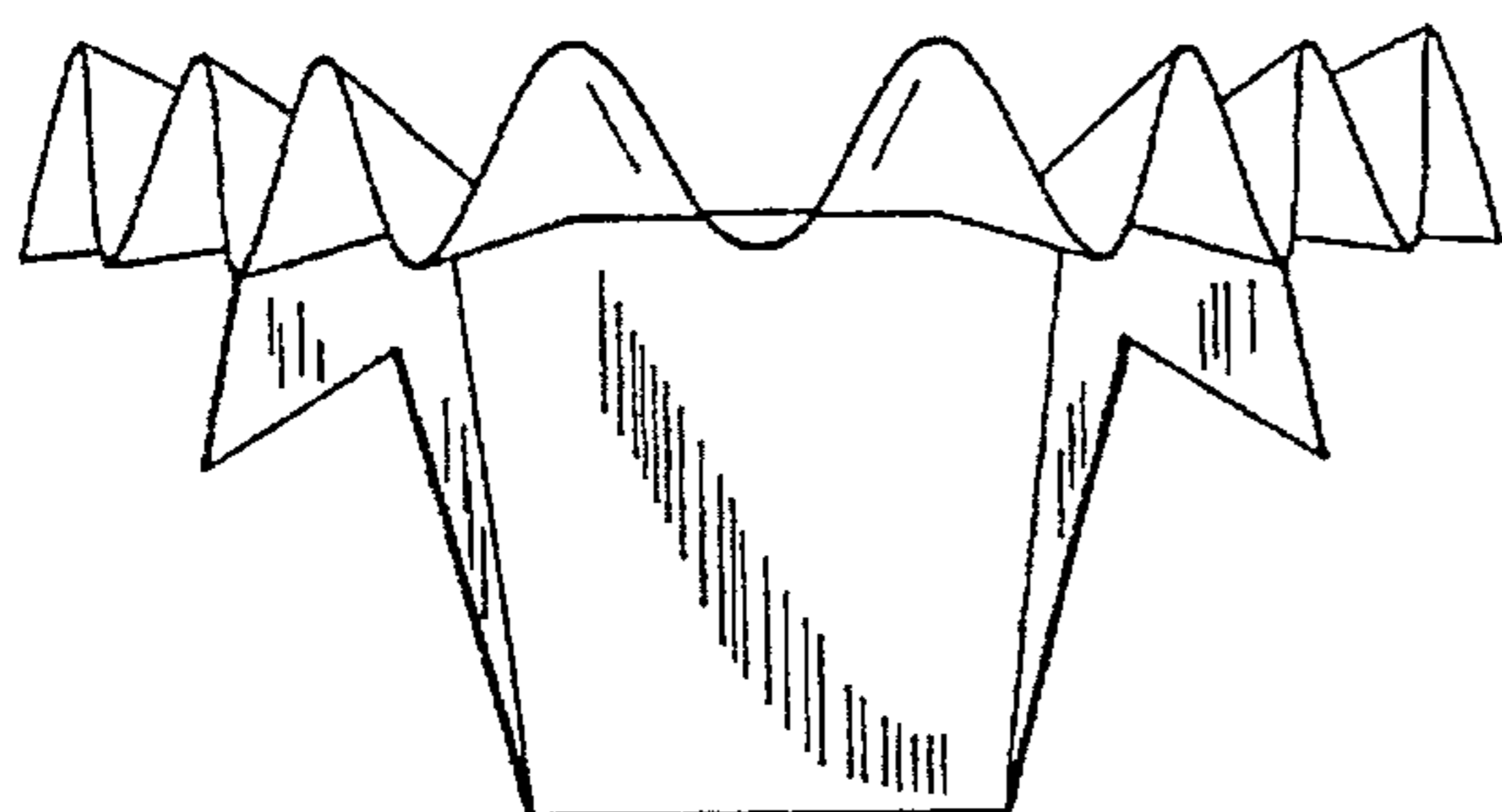

FIG. 2

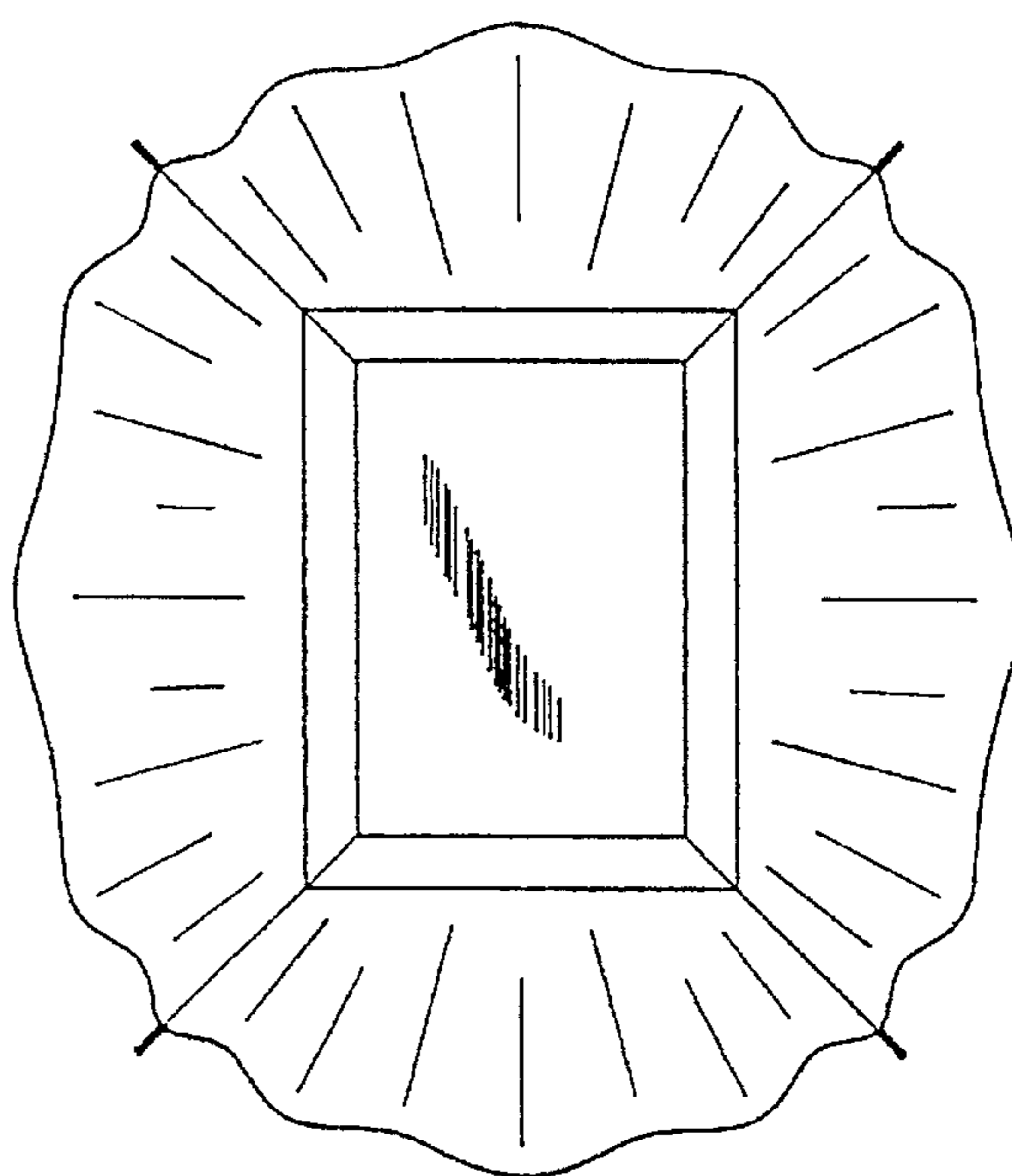

FIG. 3

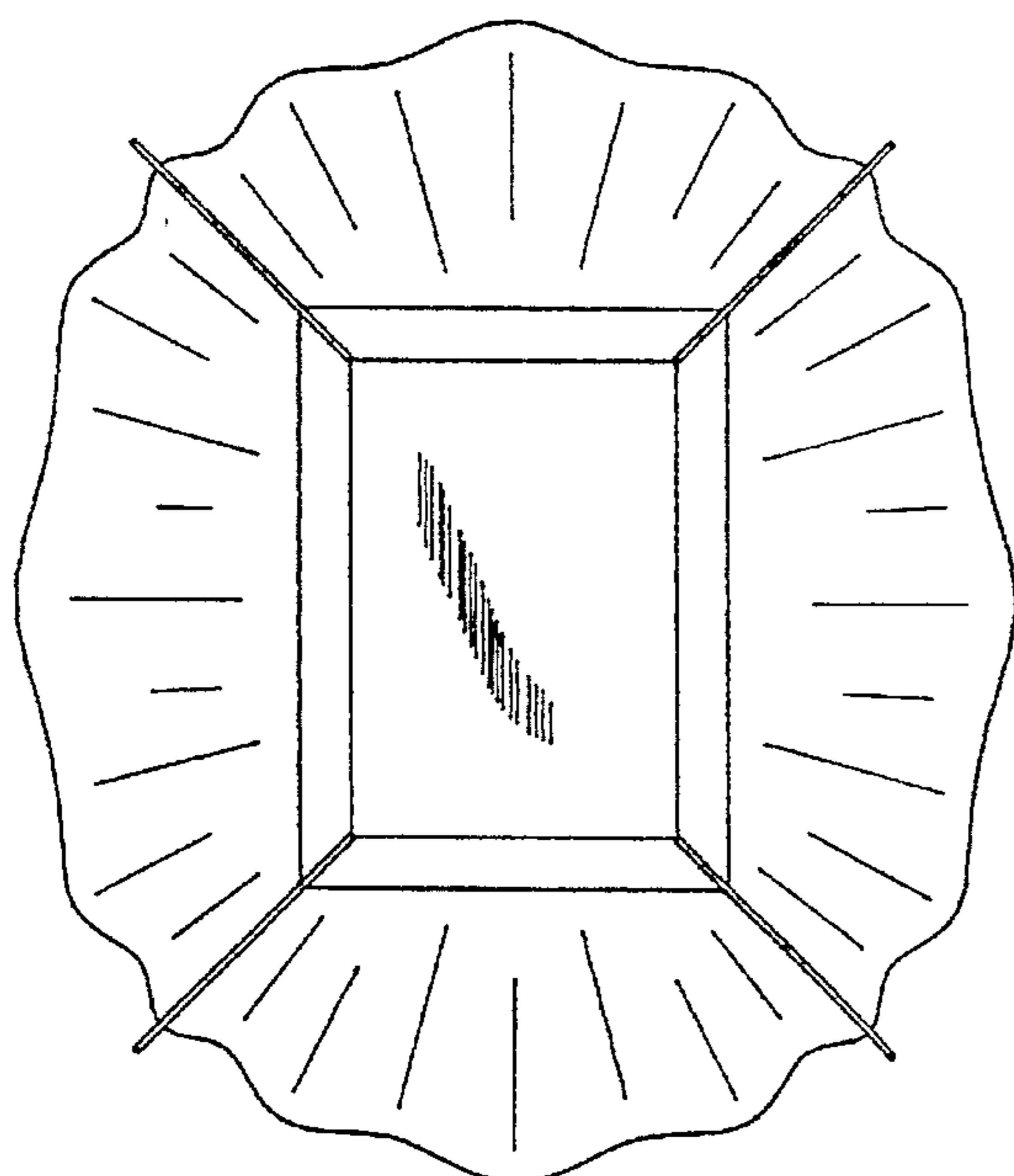

FIG. 4

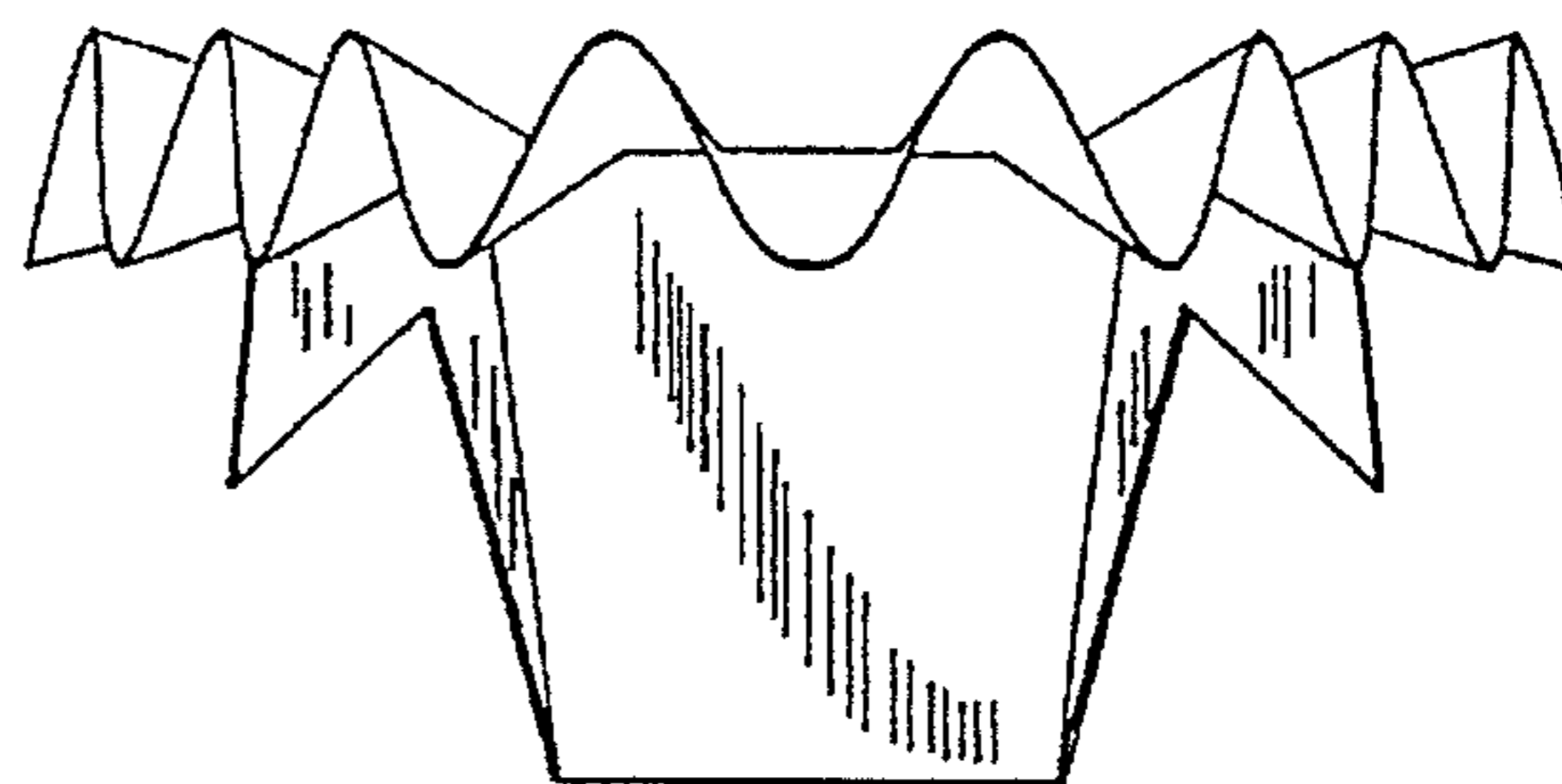

FIG. 5

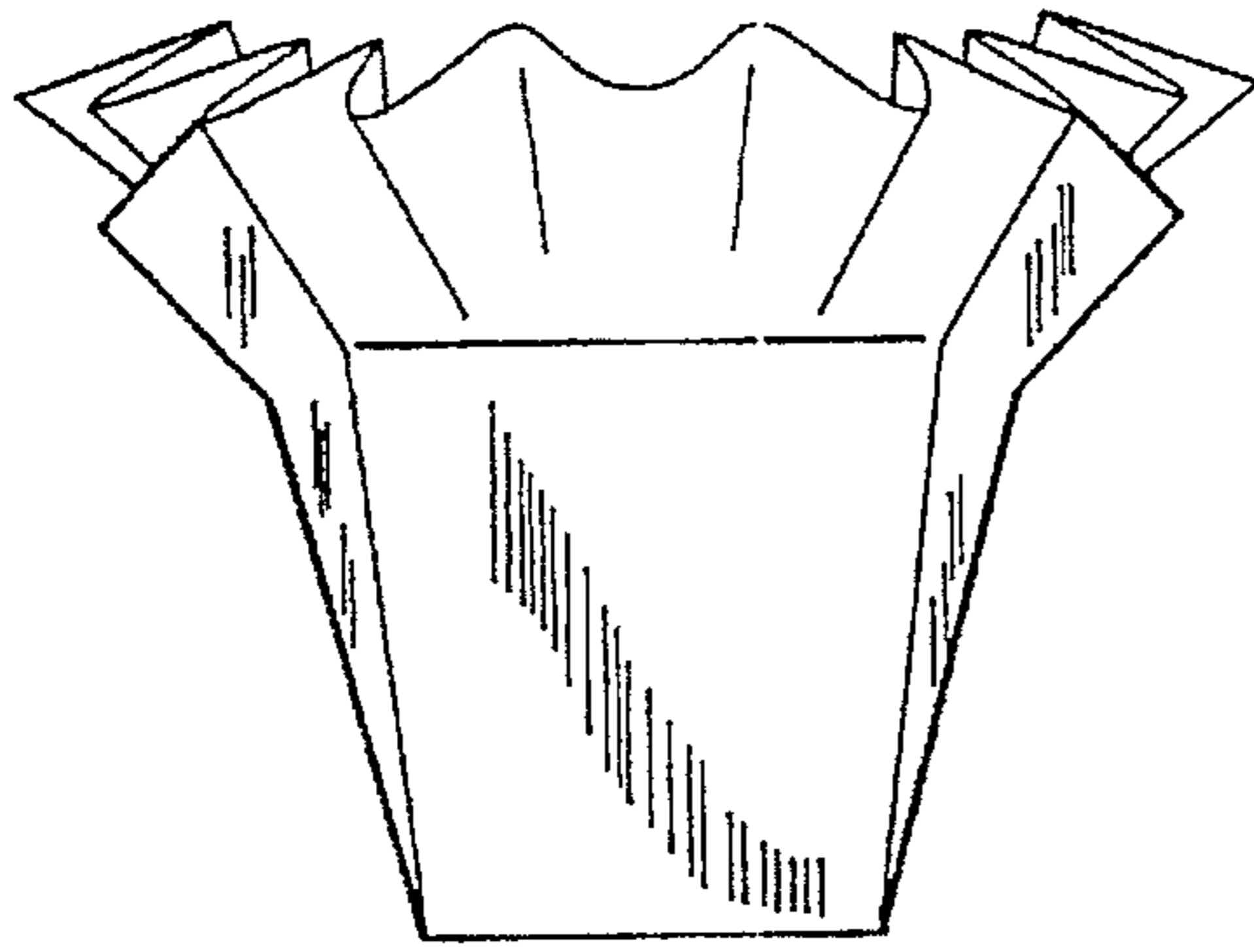

FIG. 6

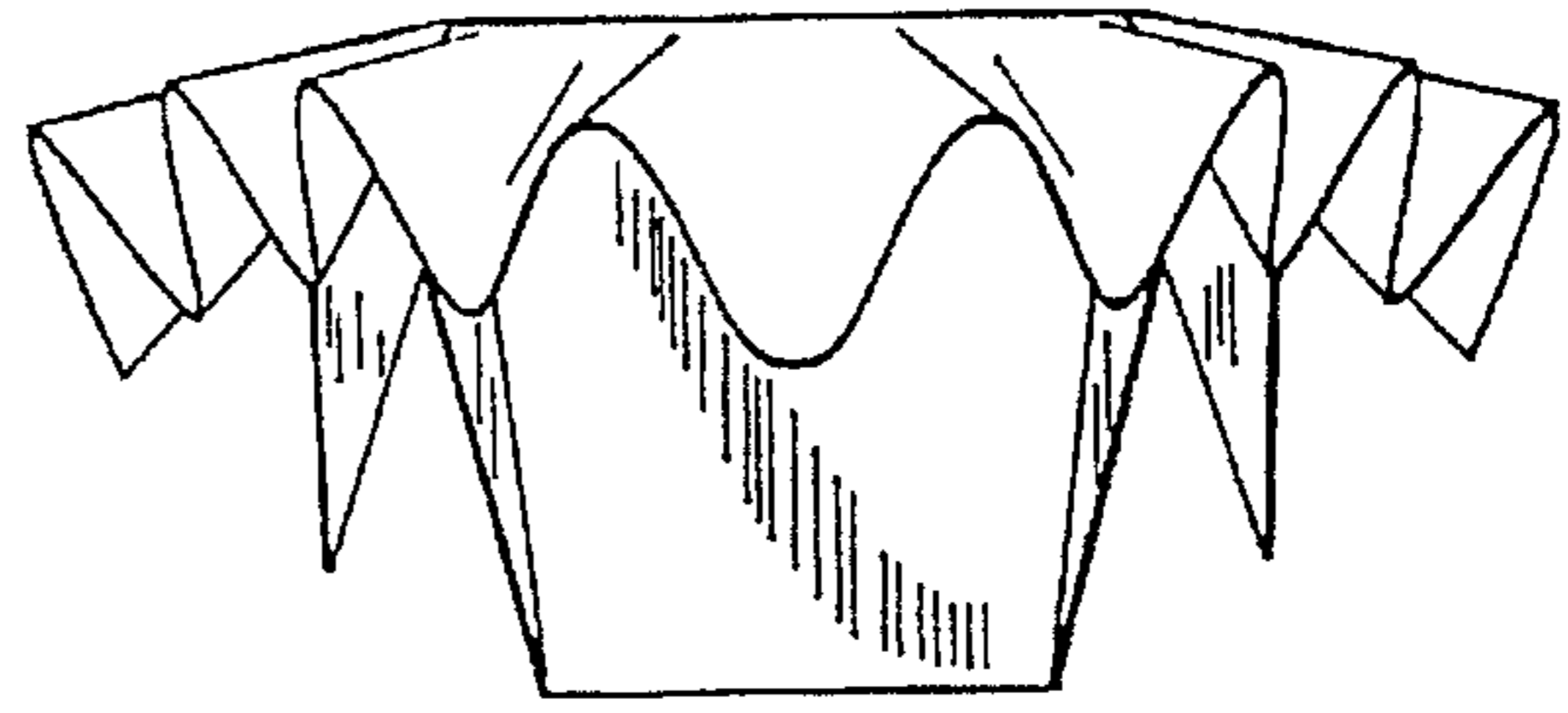

FIG. 7

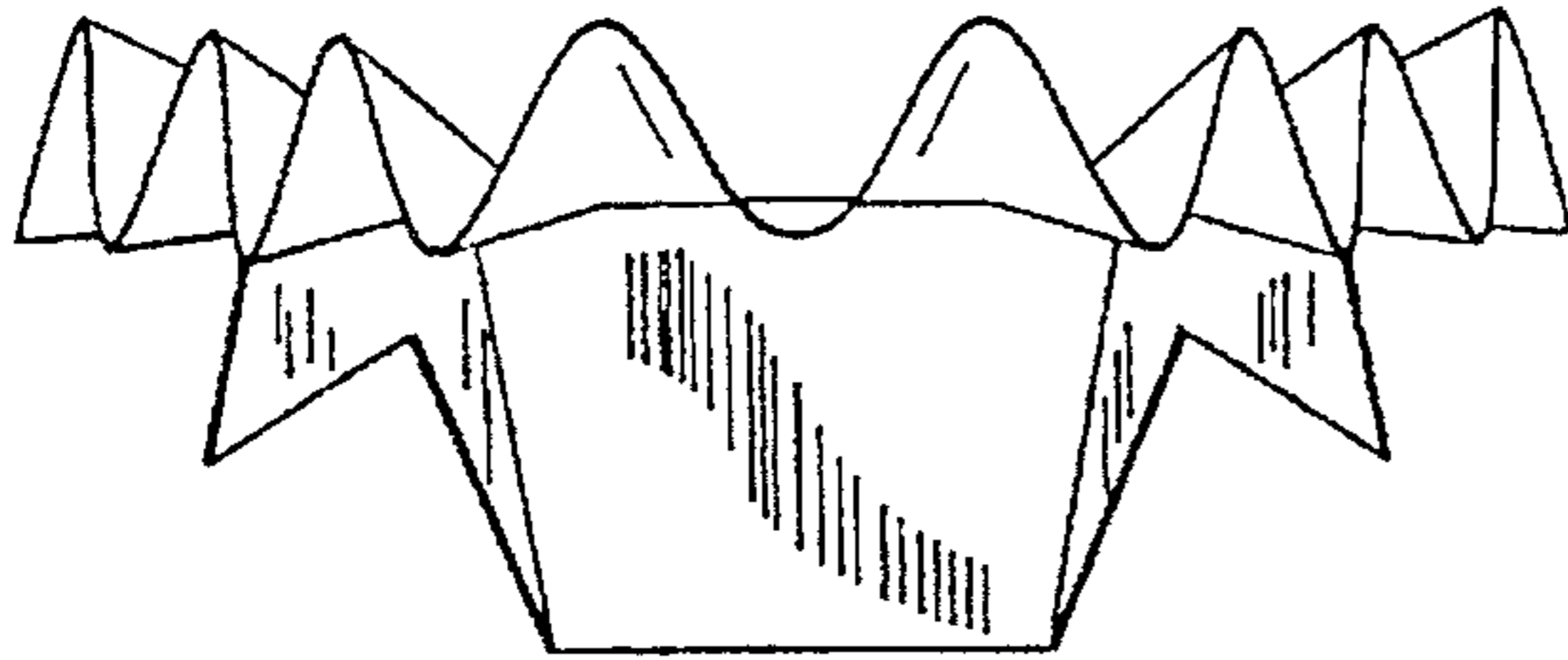

FIG. 8

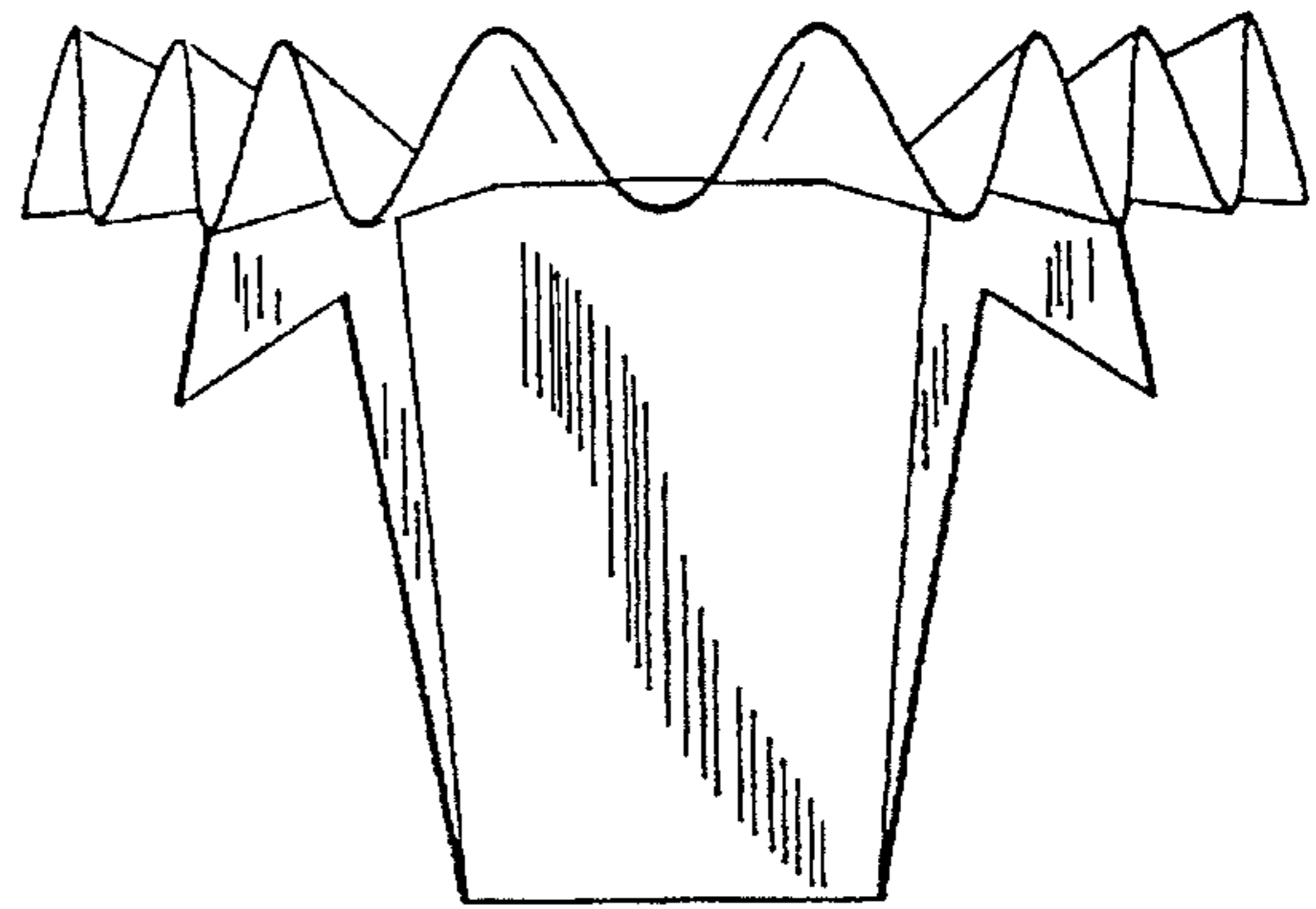

FIG. 9

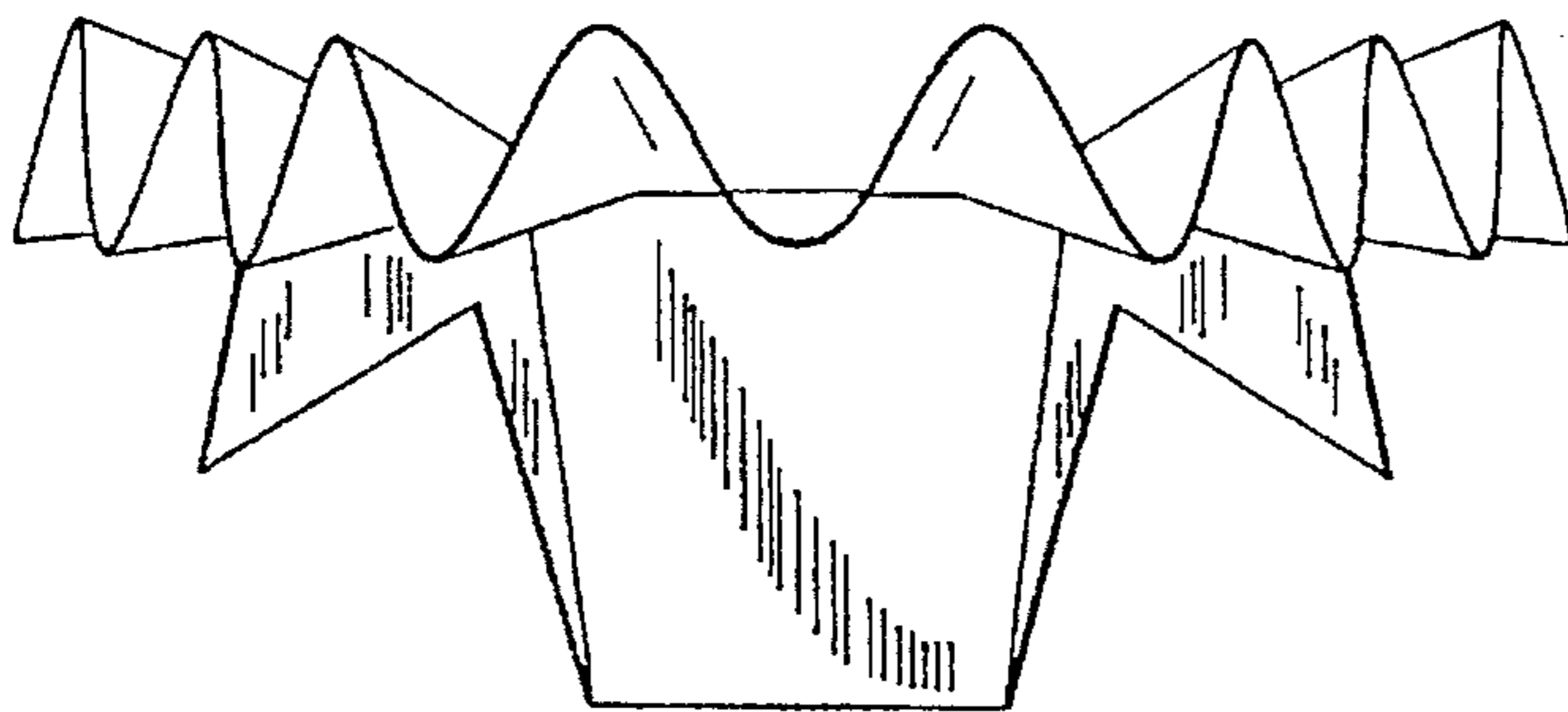

FIG. 10

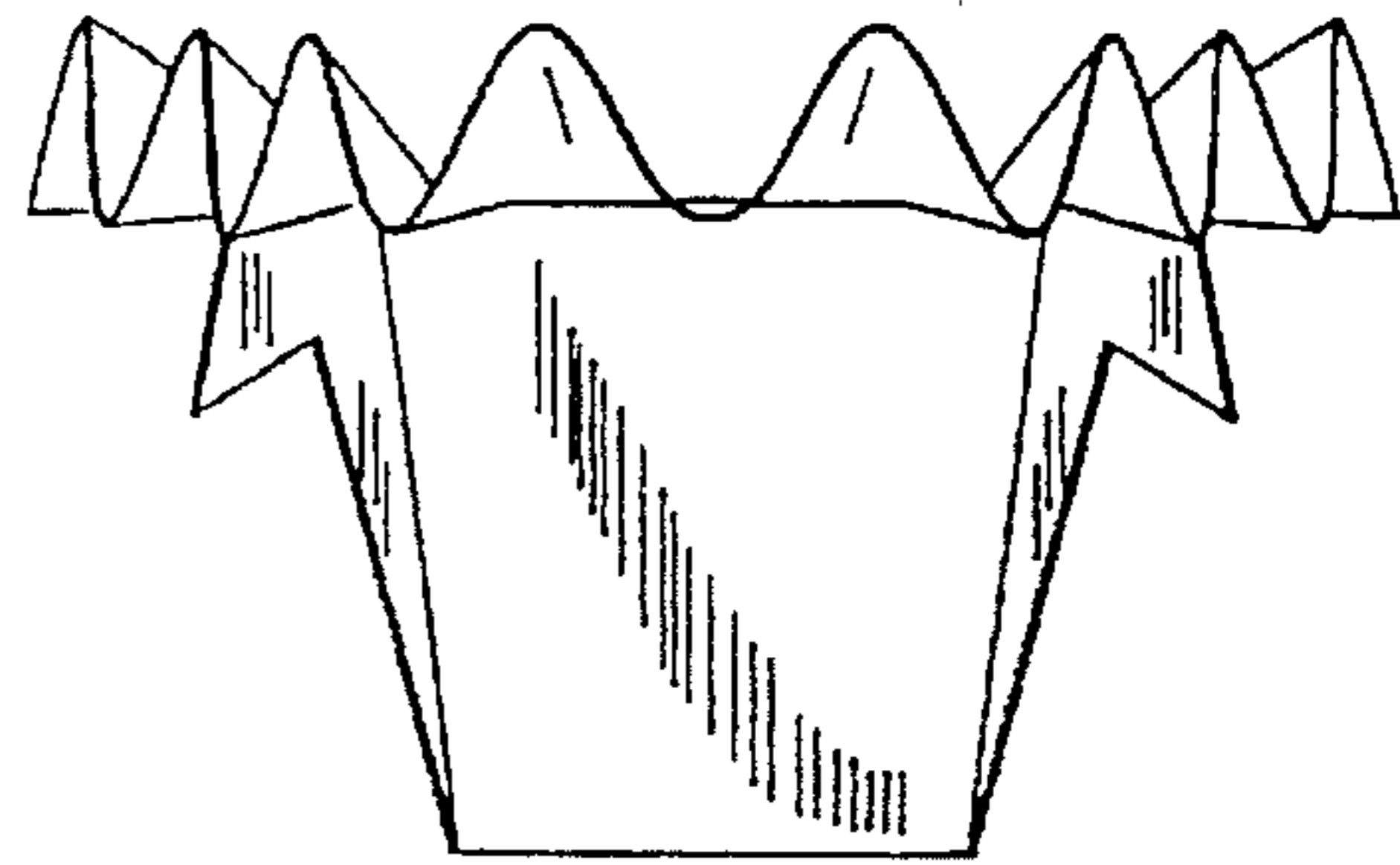

FIG. 11

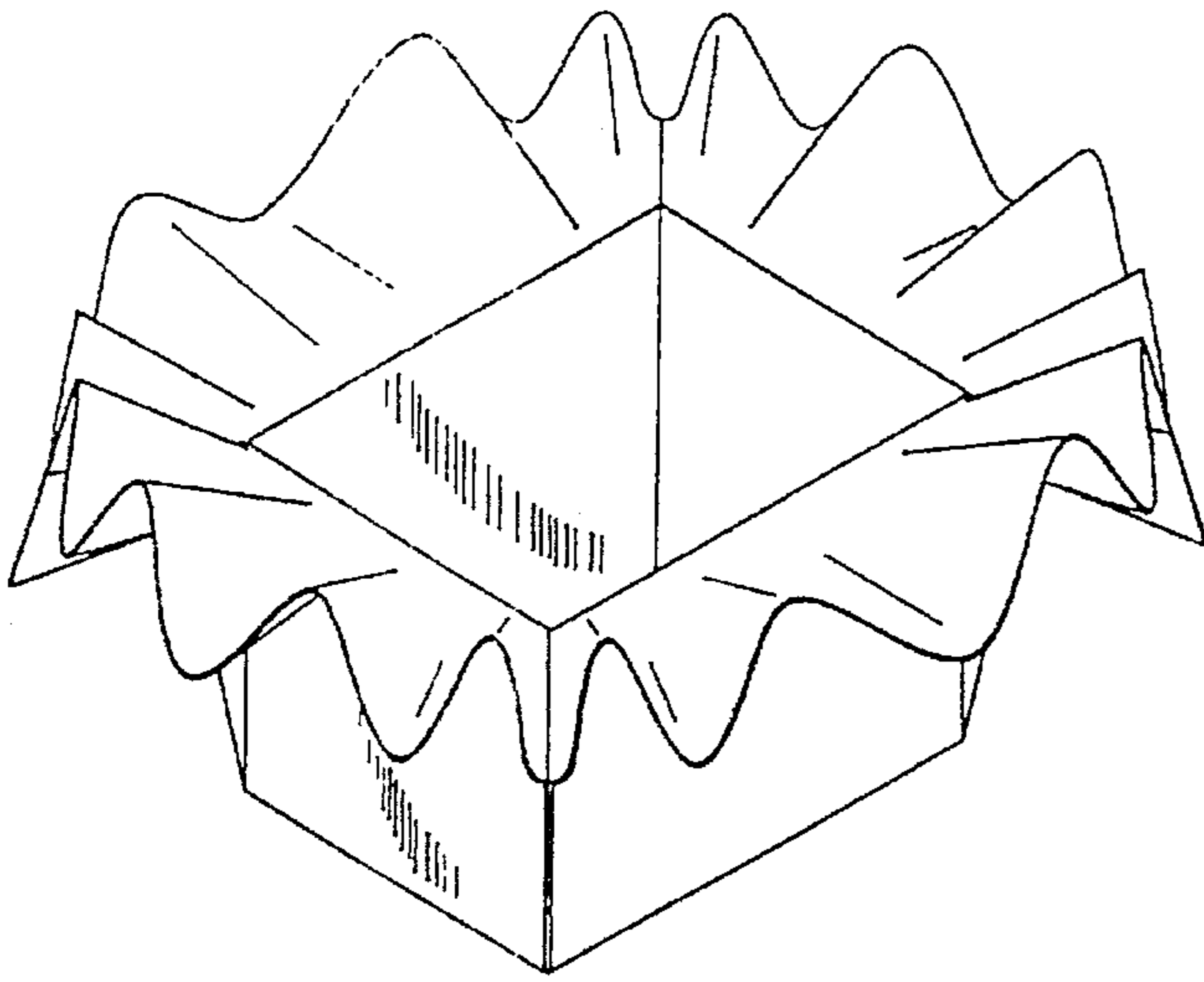

FIG. 12

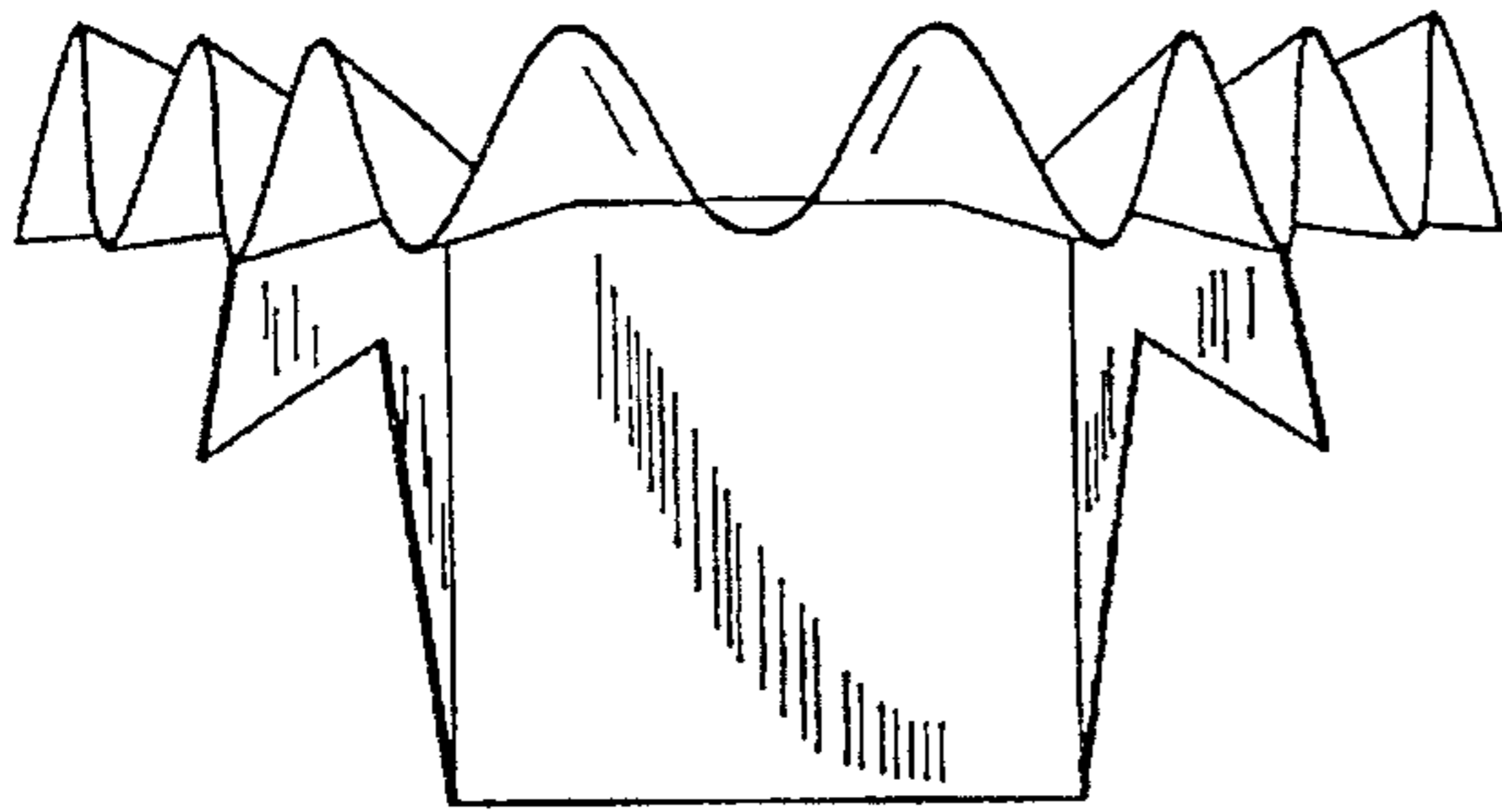

FIG. 13

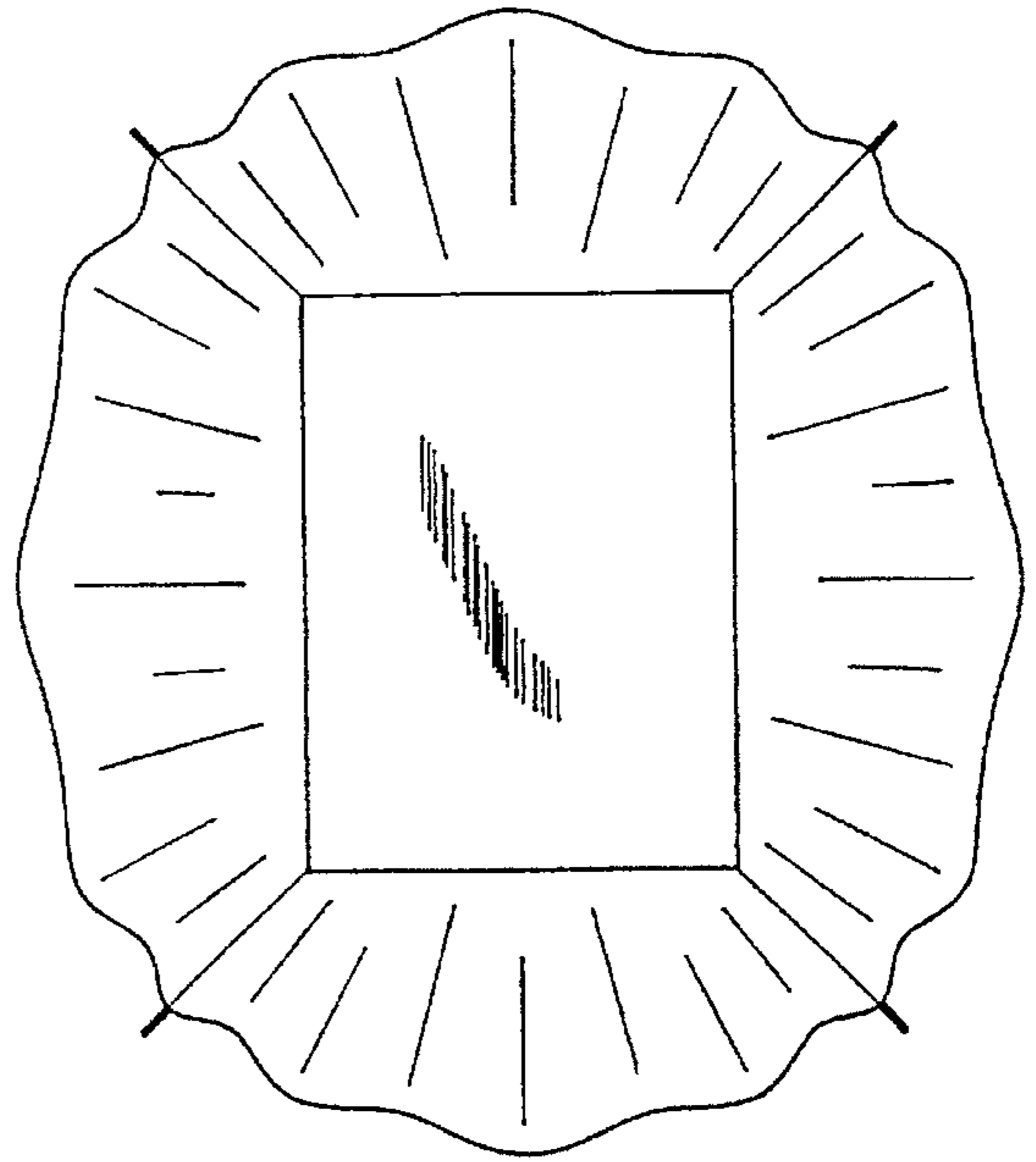

FIG. 14

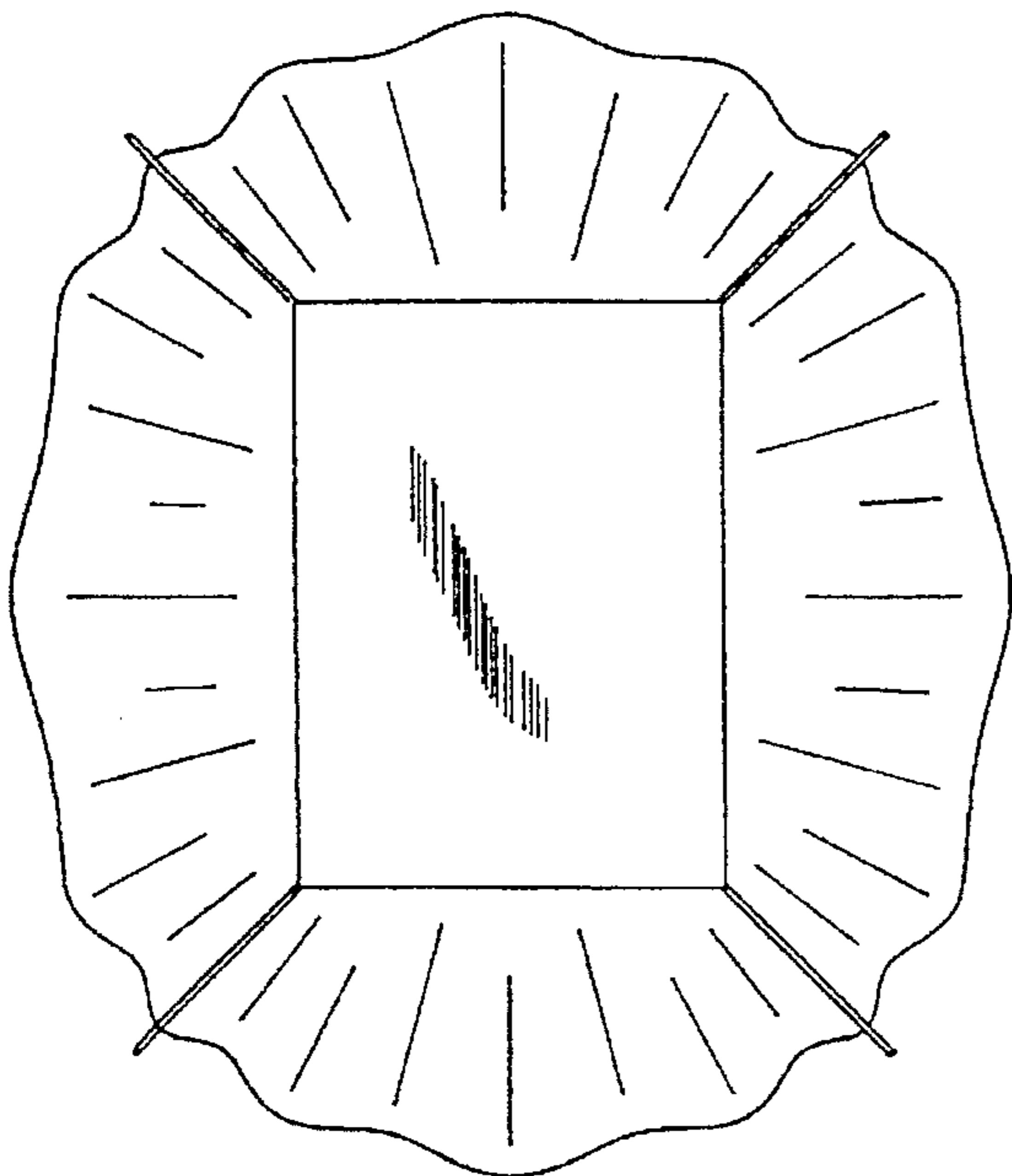

FIG. 15

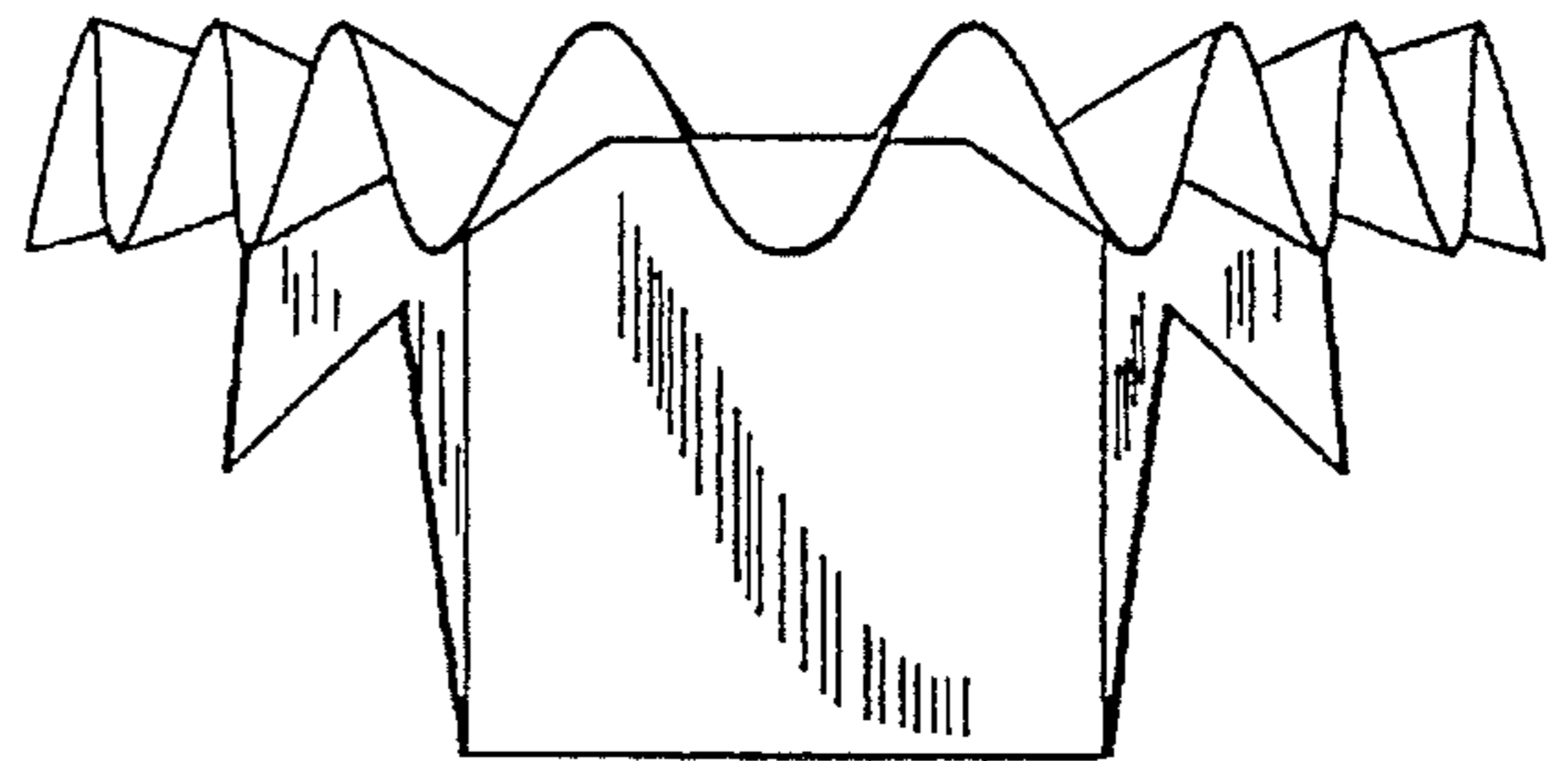

FIG. 16

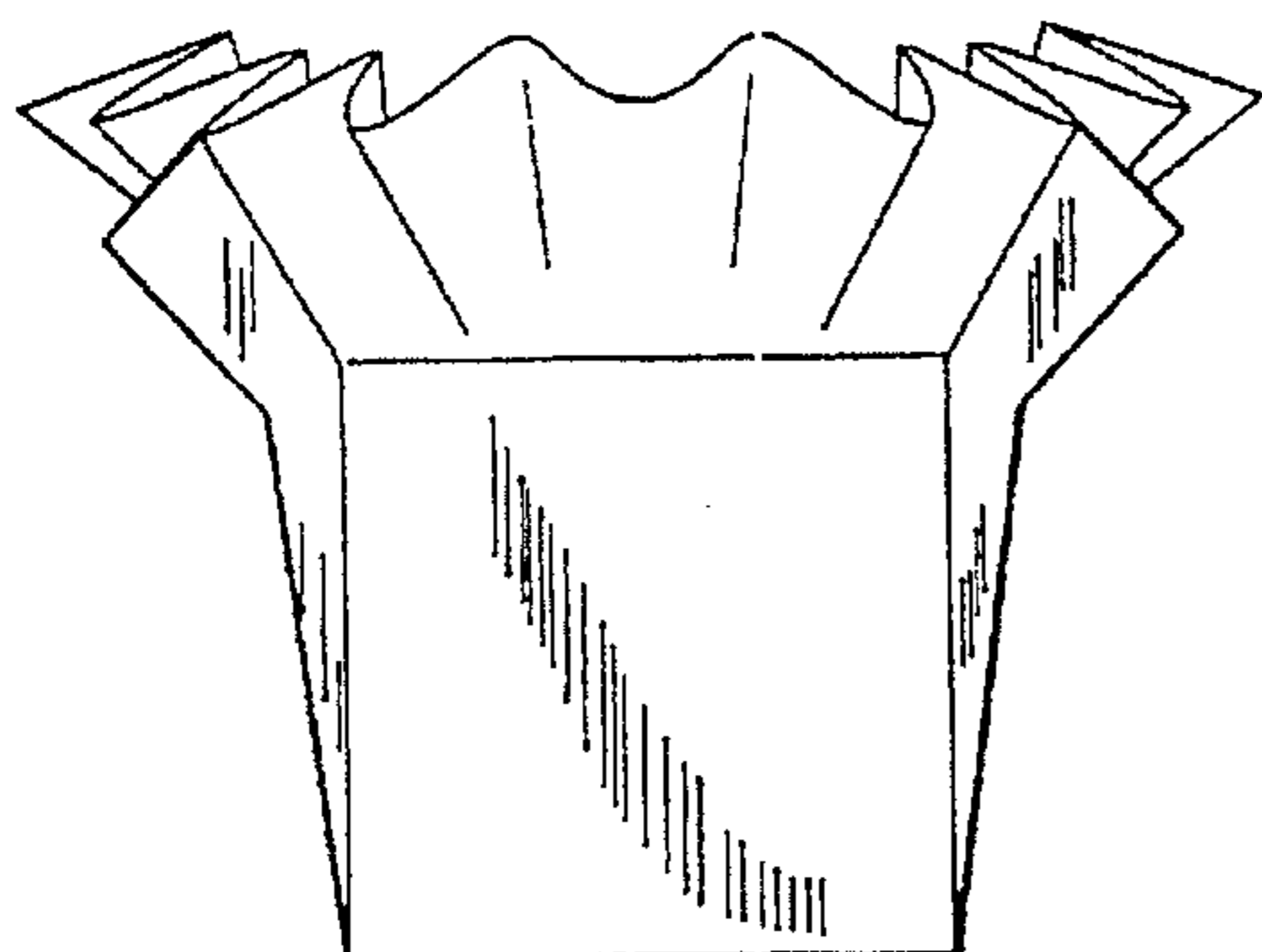

FIG. 17

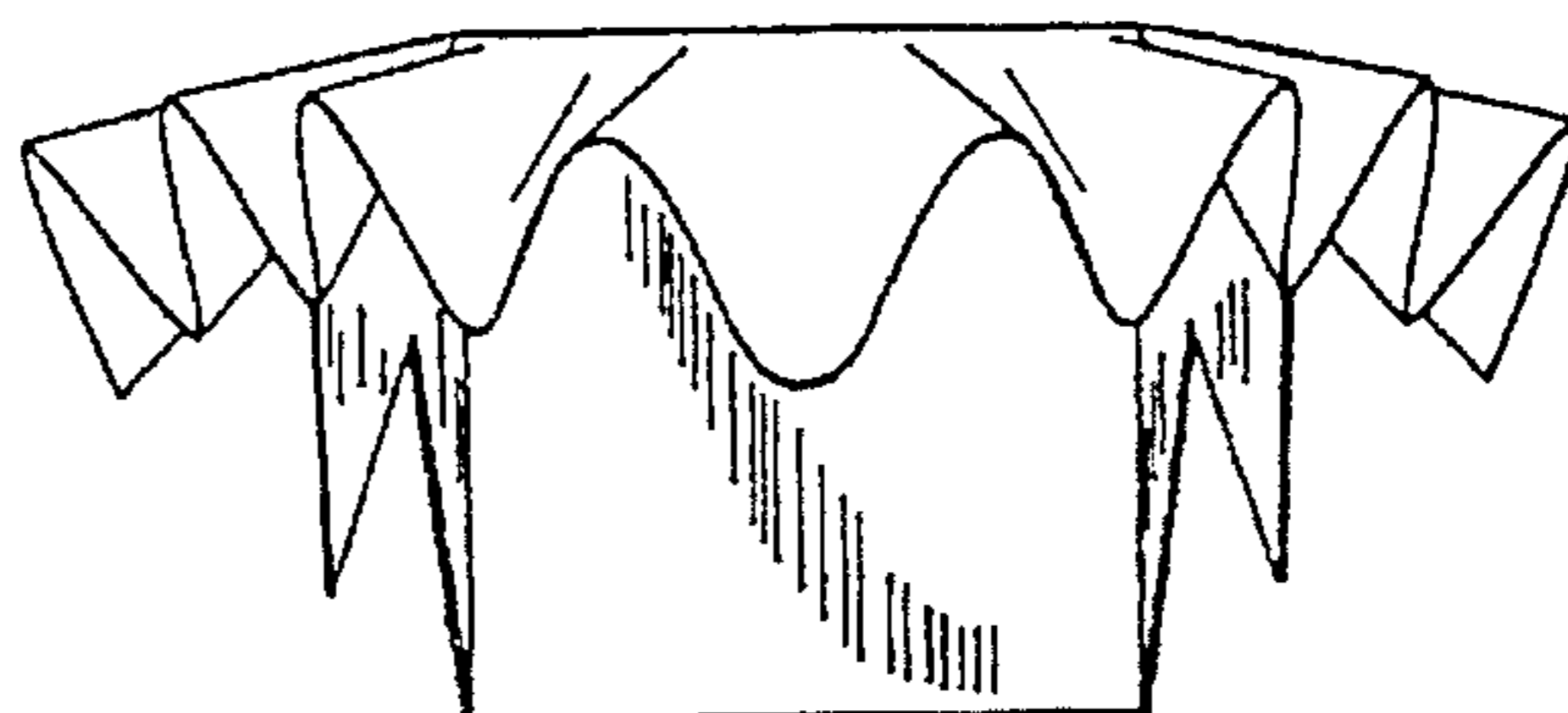

FIG. 18

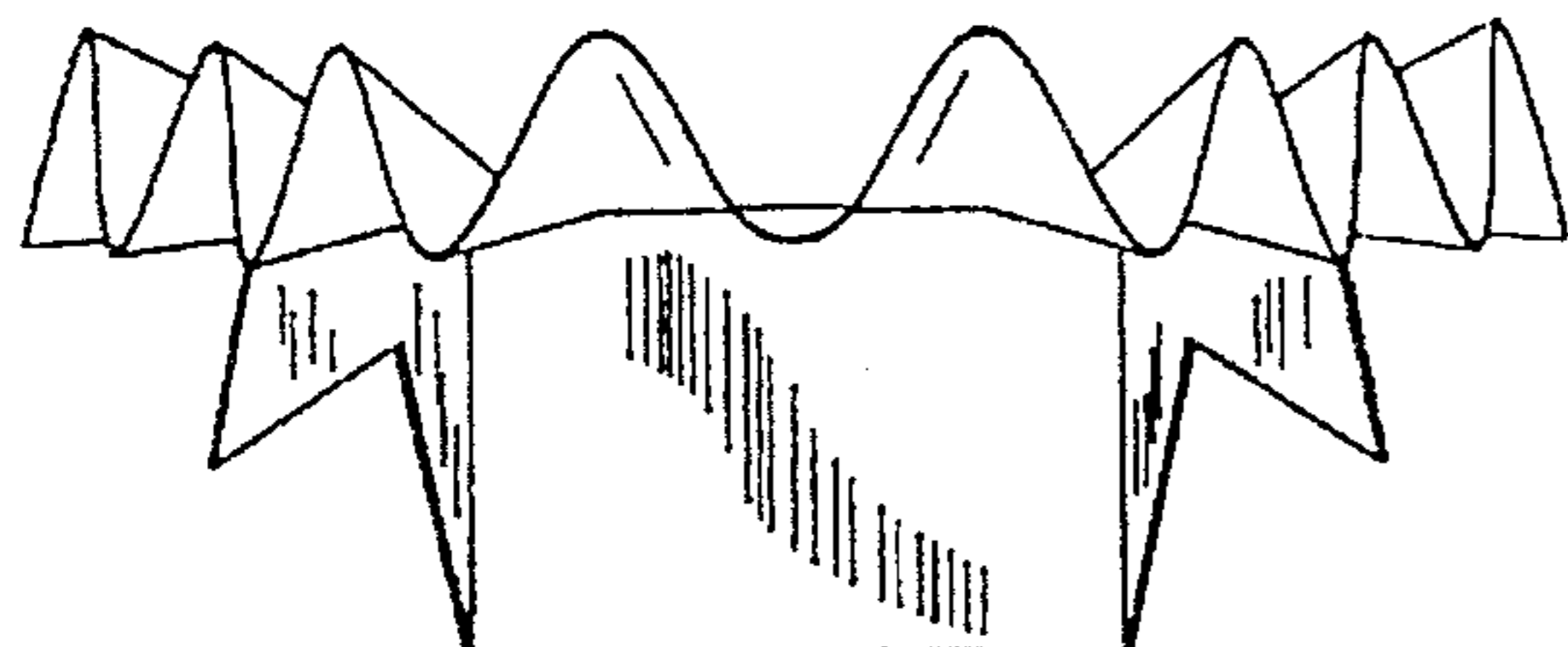

FIG. 19

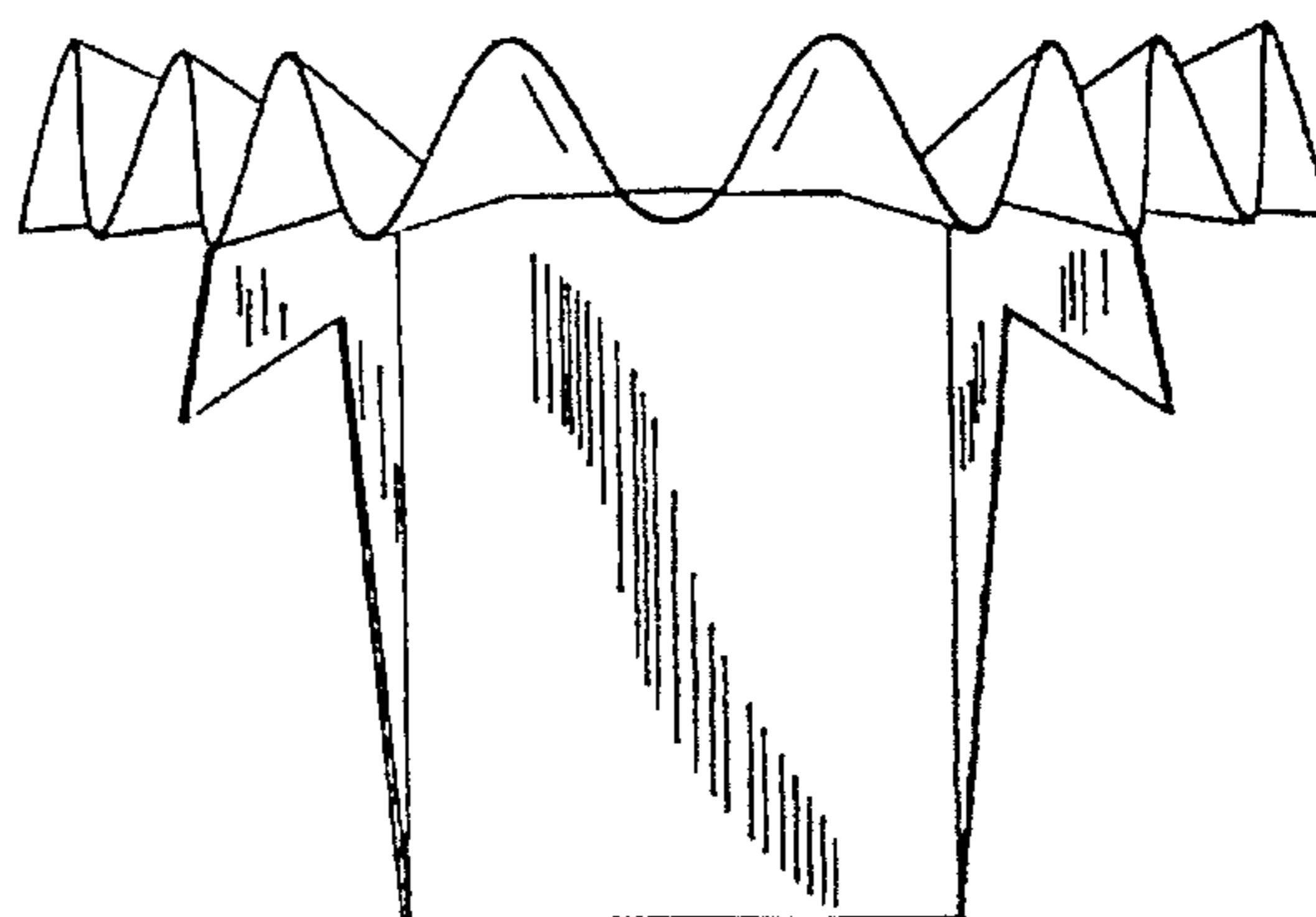

FIG. 20

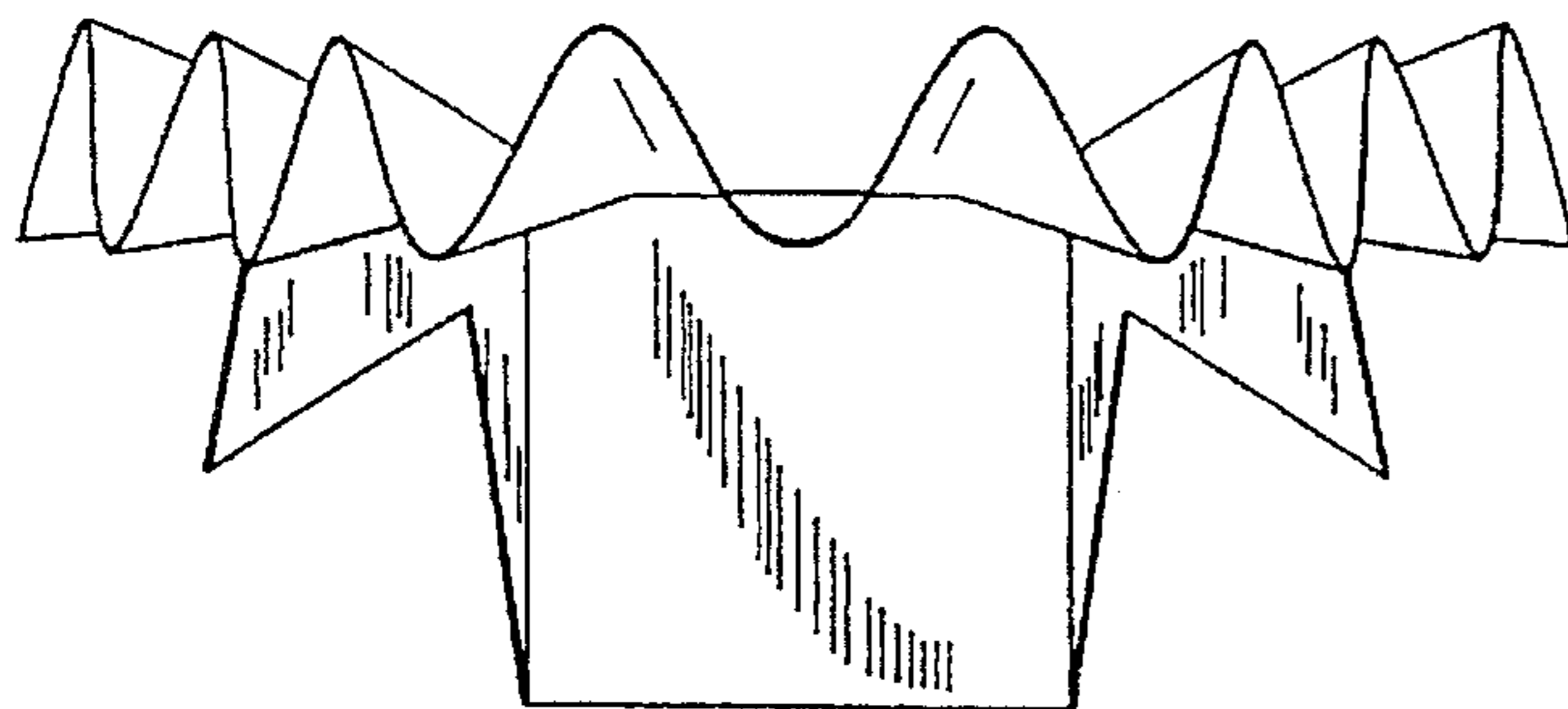

FIG. 21

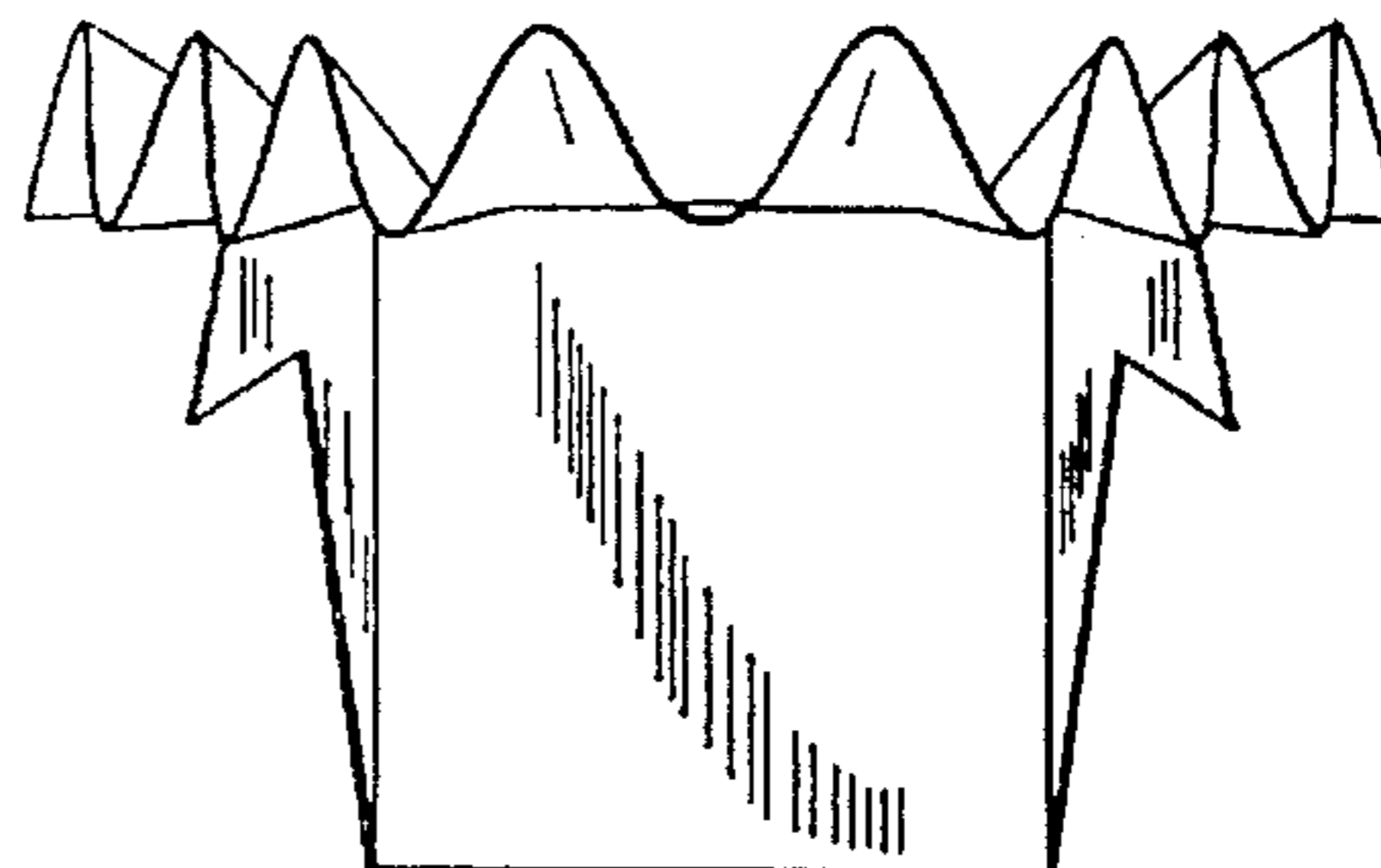

FIG. 22

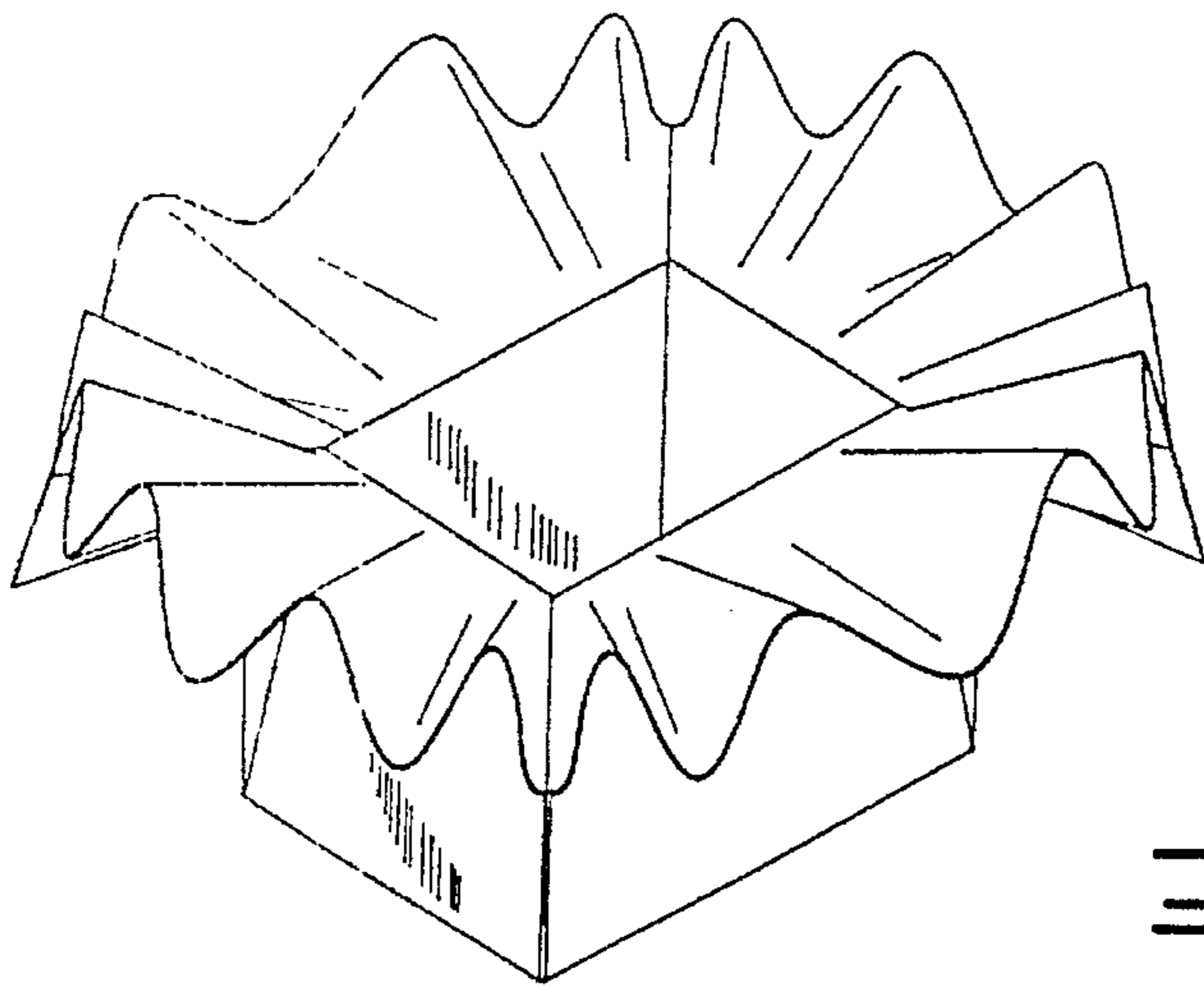

FIG. 23

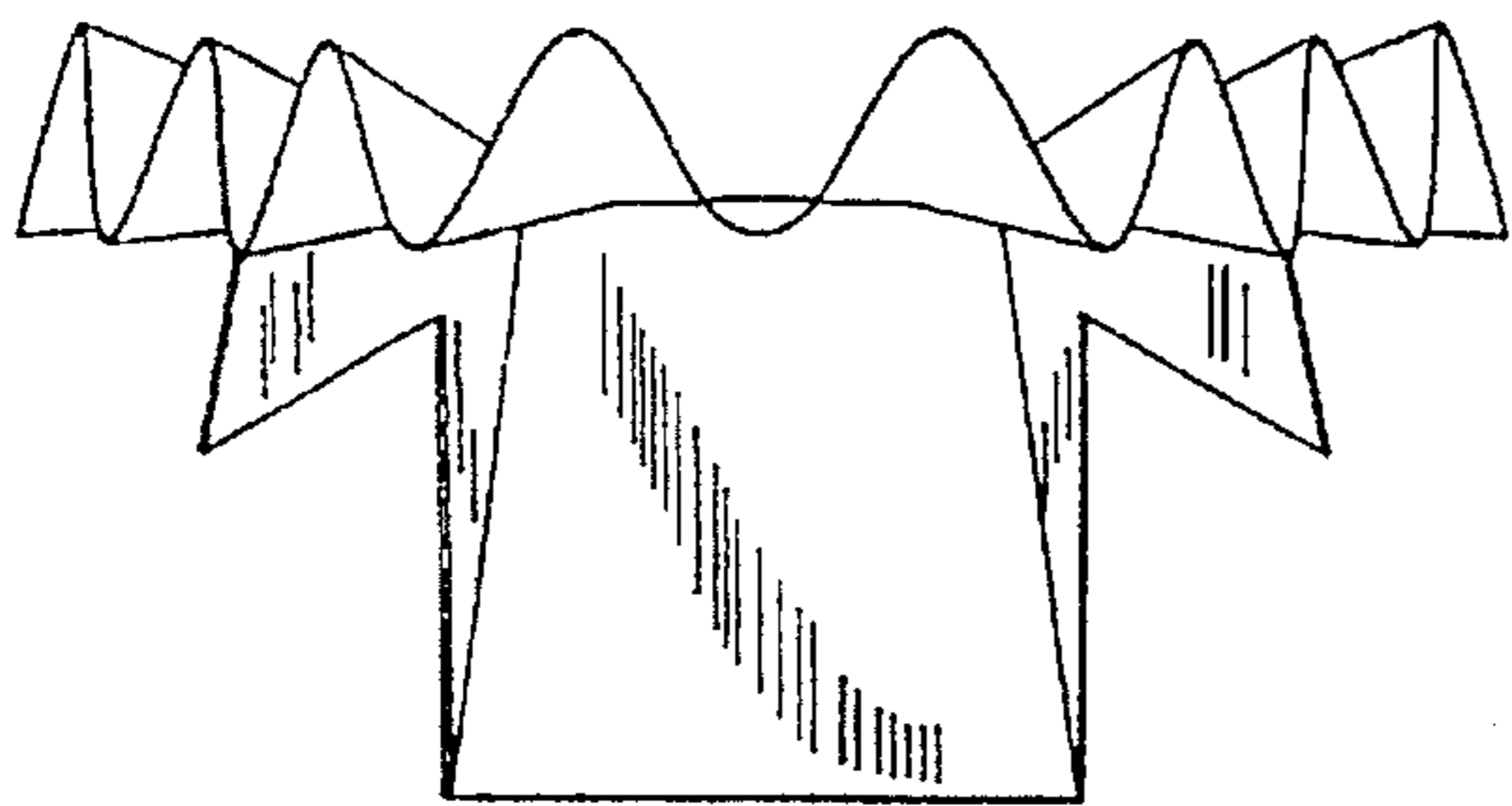

FIG. 24

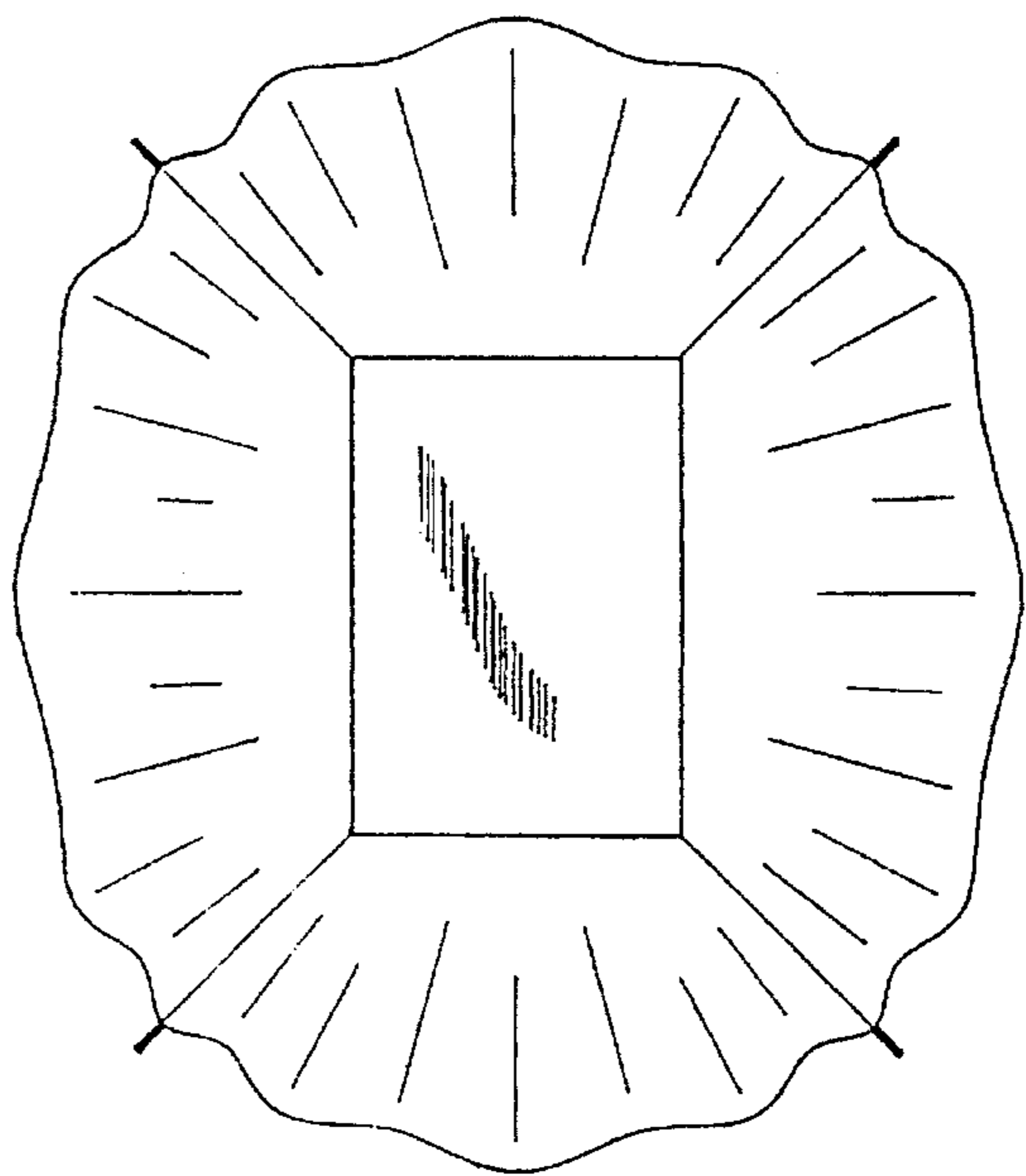

FIG. 25

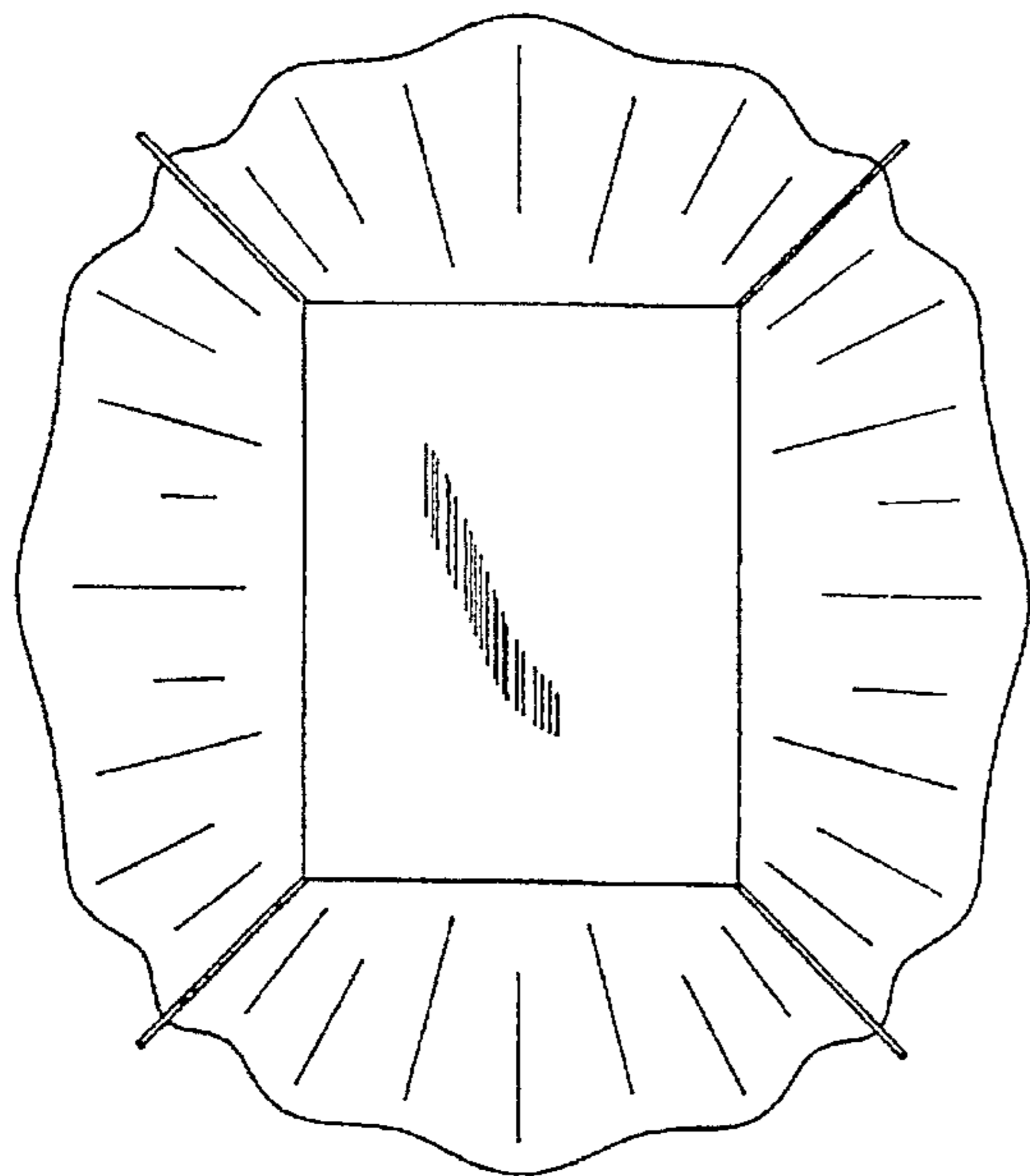

FIG. 26

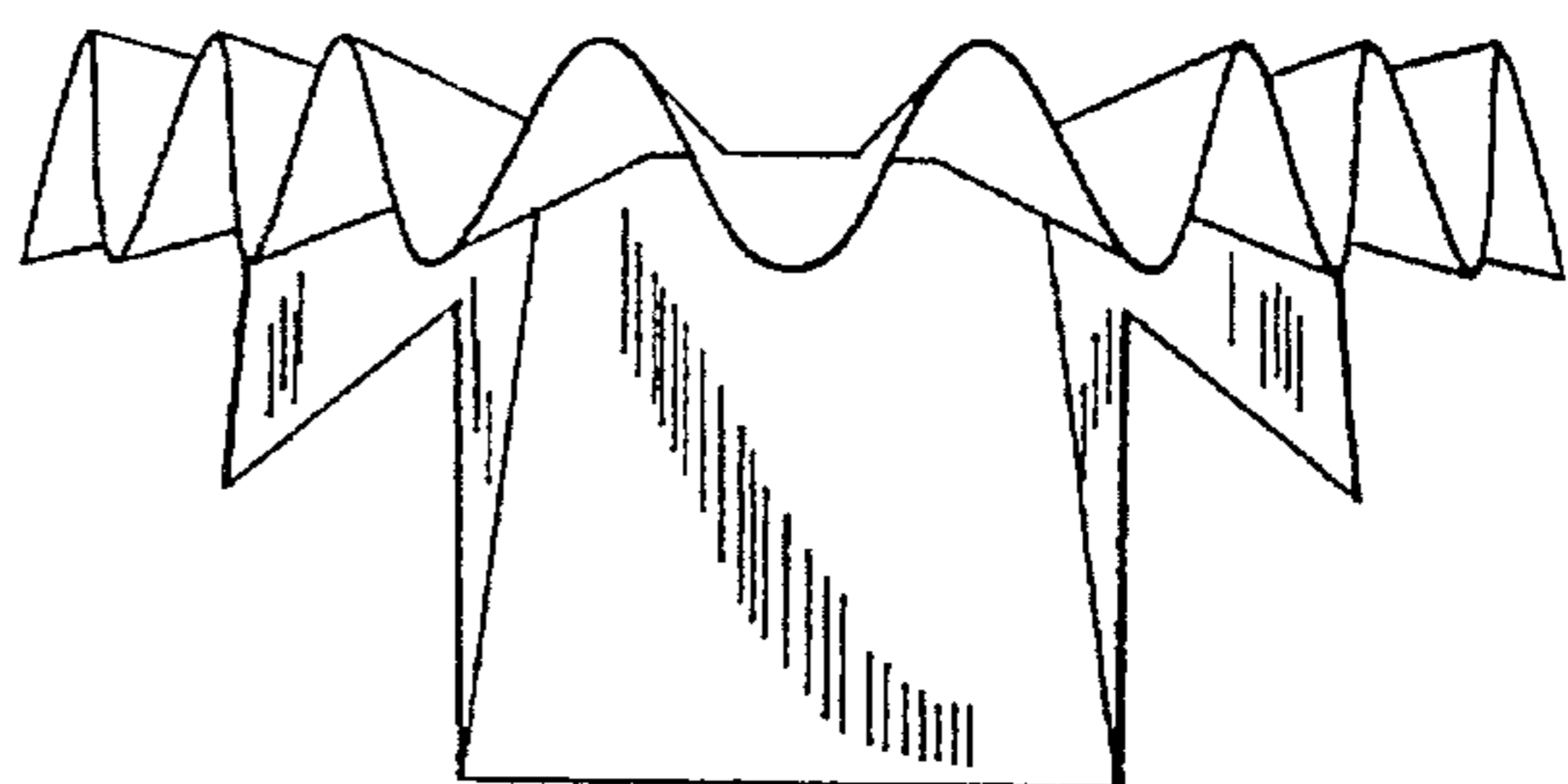

FIG. 27

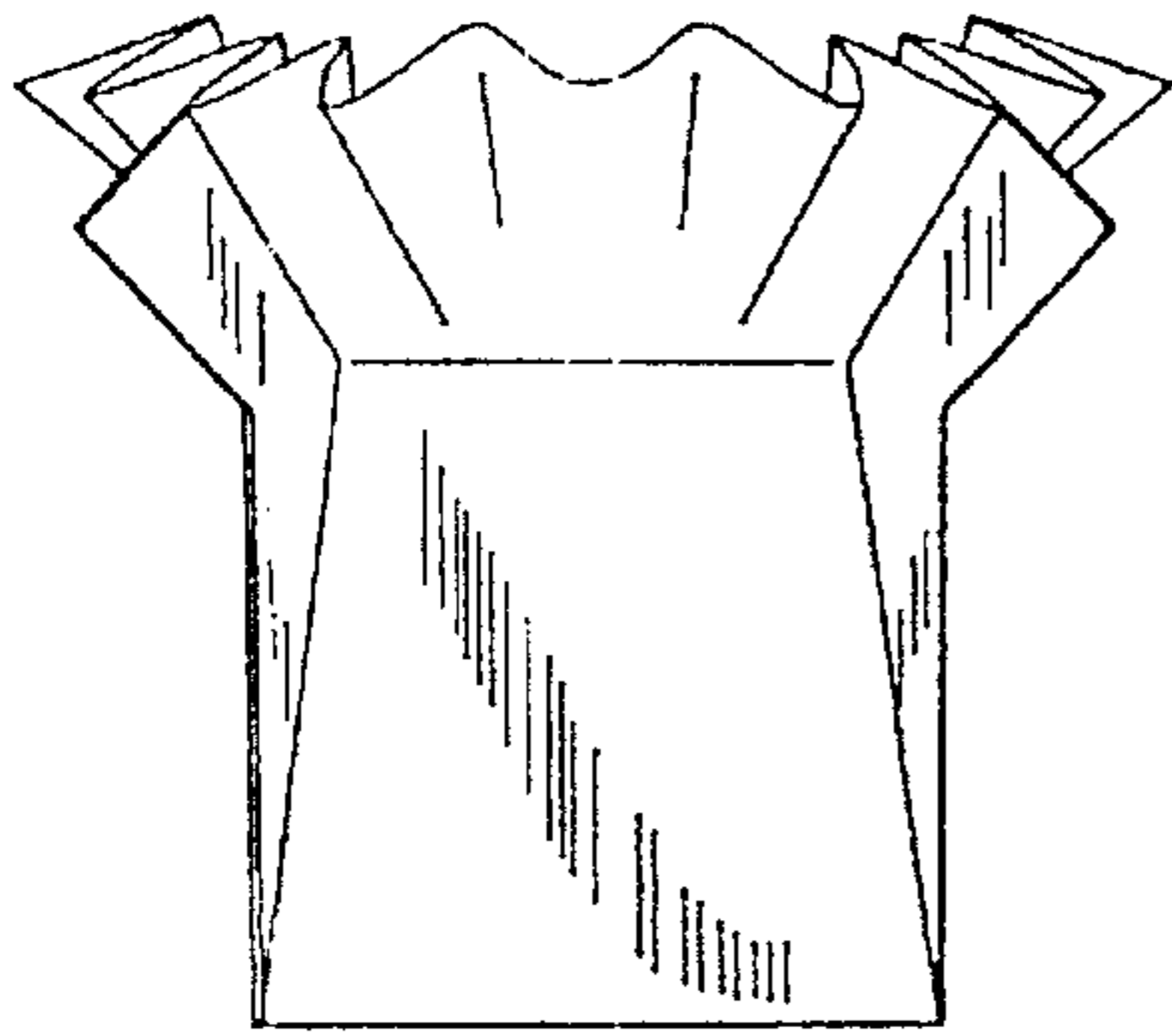

FIG. 28

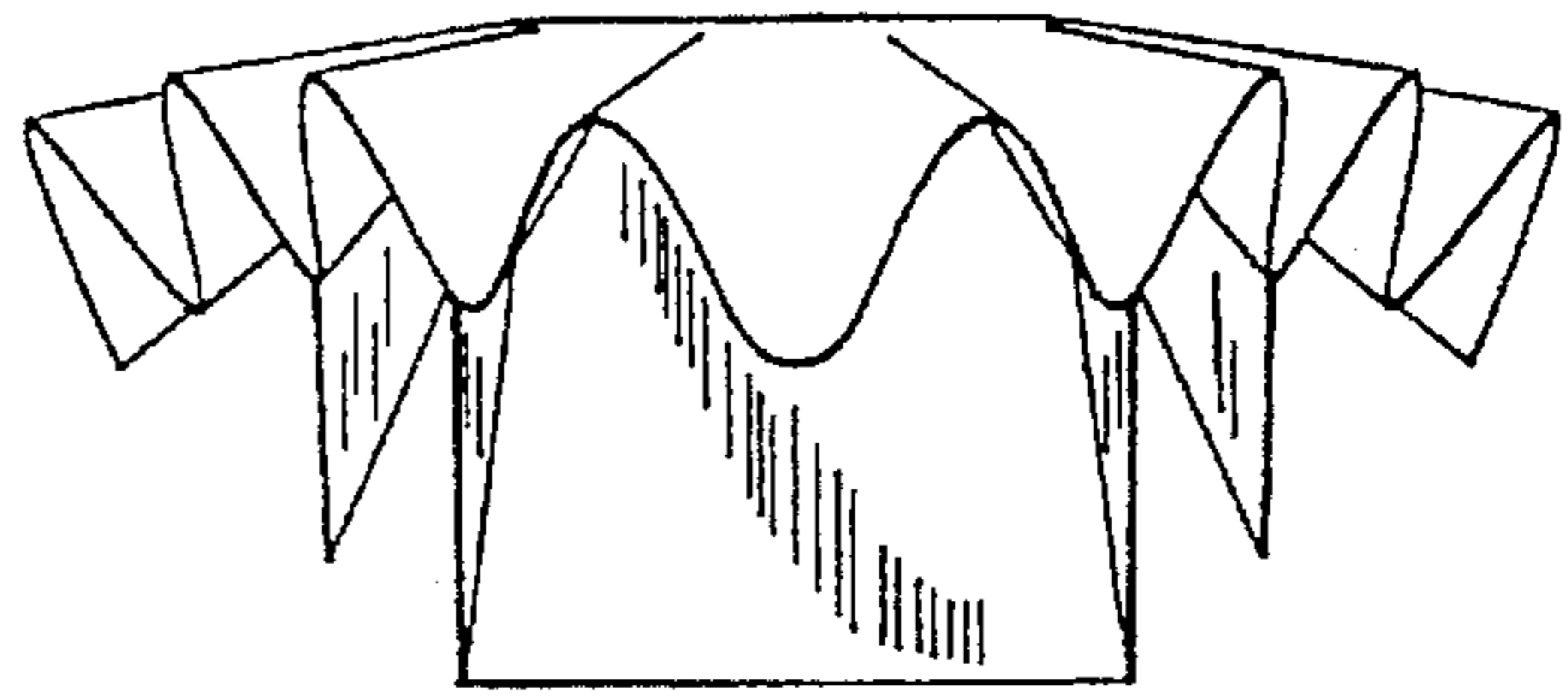

FIG. 29

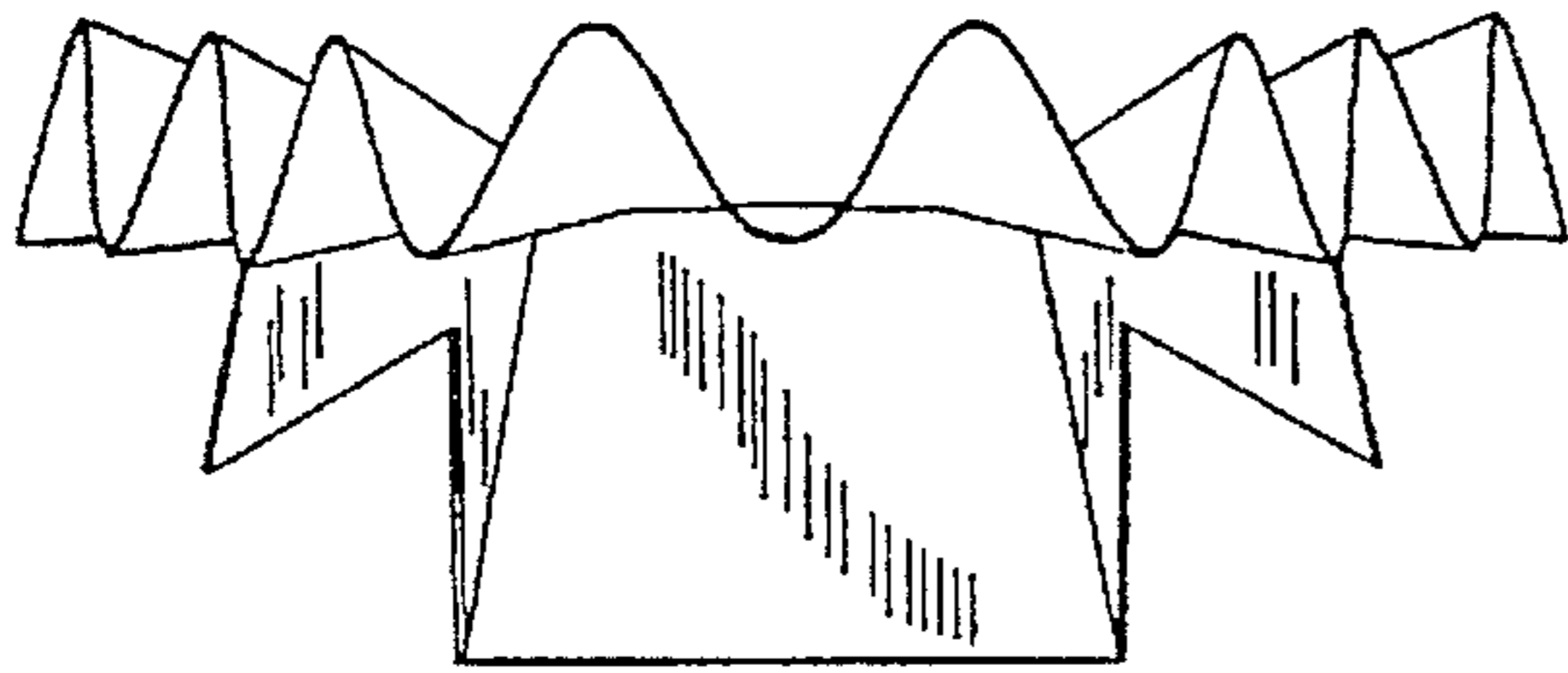

FIG. 30

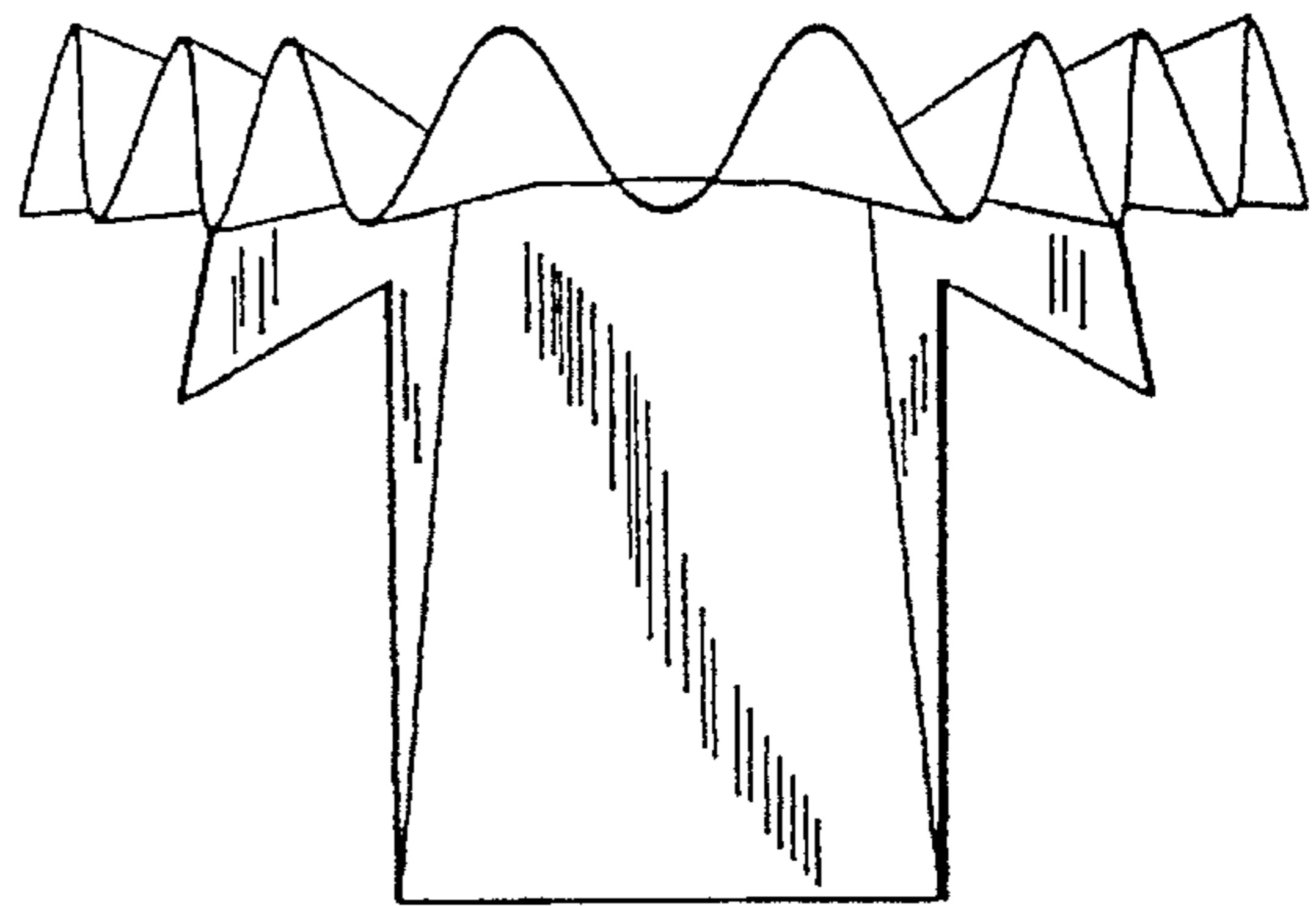

FIG. 31

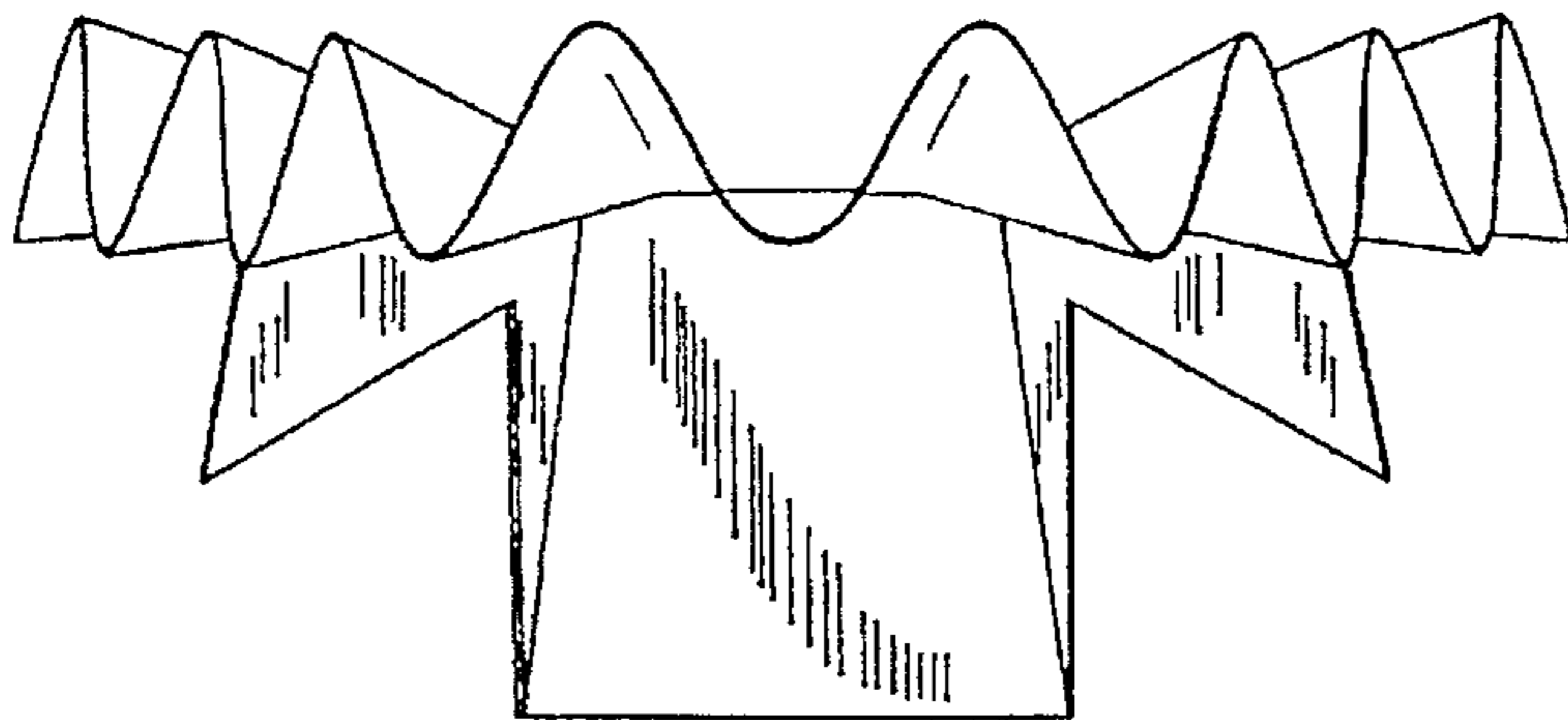

FIG. 32

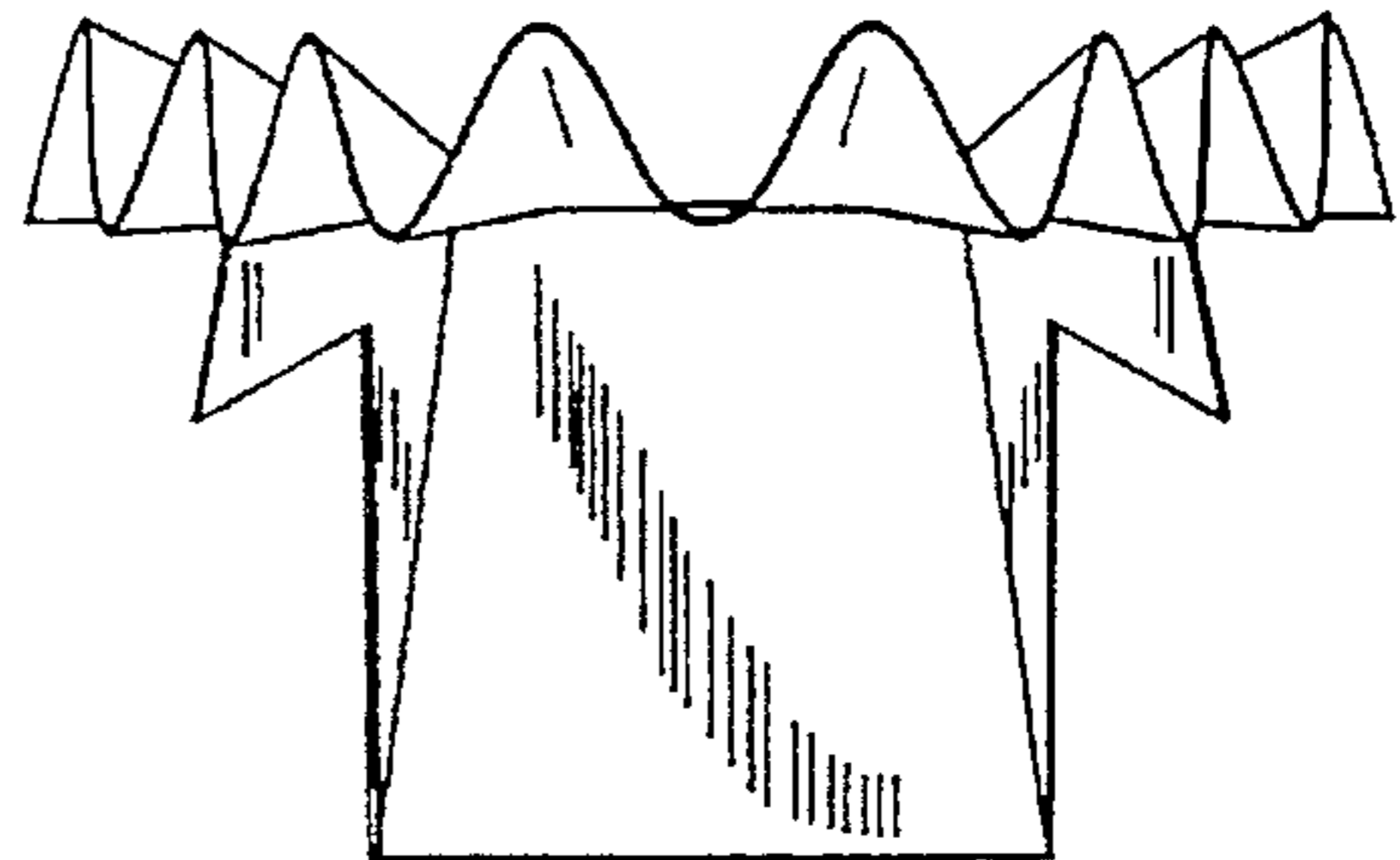

FIG. 33