



US00D380353S

United States Patent [19]

Cohen et al.

[11] Patent Number: **Des. 380,353**

[45] Date of Patent: ****Jul. 1, 1997**

[54] **STORAGE CAROUSEL FOR KNIVES AND KITCHEN TOOLS, UTENSILS AND GADGETS**

[75] Inventors: **Milton L. Cohen**, Hewlett Bay Park;
Jeff Siegel, Great Neck, both of N.Y.

[73] Assignee: **Lifetime Hoan Corporation**, Westbury, N.Y.

[**] Term: **14 Years**

[21] Appl. No.: **52,875**

[22] Filed: **Apr. 10, 1996**

[51] LOC (6) Cl. **06-04**

[52] U.S. Cl. **D7/641; D19/75**

[58] Field of Search **D7/637-641; D19/75, D19/77, 78, 81, 84, 85; 206/553; 211/60.1, 70, 70.6, 70.7, 71, 163; 248/37.3**

[56] **References Cited**

U.S. PATENT DOCUMENTS

- D. 349,011 7/1994 Cohen et al. D7/641
- D. 360,811 8/1995 Cohen et al. D7/641

Primary Examiner—Terry A. Wallace

Attorney, Agent, or Firm—Goodman & Teitelbaum, Esqs.

[57] **CLAIM**

The ornamental design for a storage carousel for knives and kitchen tools, utensils and gadgets, as shown.

DESCRIPTION

FIG. 1 is a perspective view of a storage carousel for knives and kitchen tools, utensils and gadgets, showing our new design;

FIG. 2 is a front elevational view thereof;

FIG. 3 is a left side elevational view thereof;

FIG. 4 is a rear elevational view thereof;

FIG. 5 is a right side elevational view thereof;

FIG. 6 is a top plan view thereof; and,

FIG. 7 is a bottom plan view thereof.

1 Claim, 2 Drawing Sheets

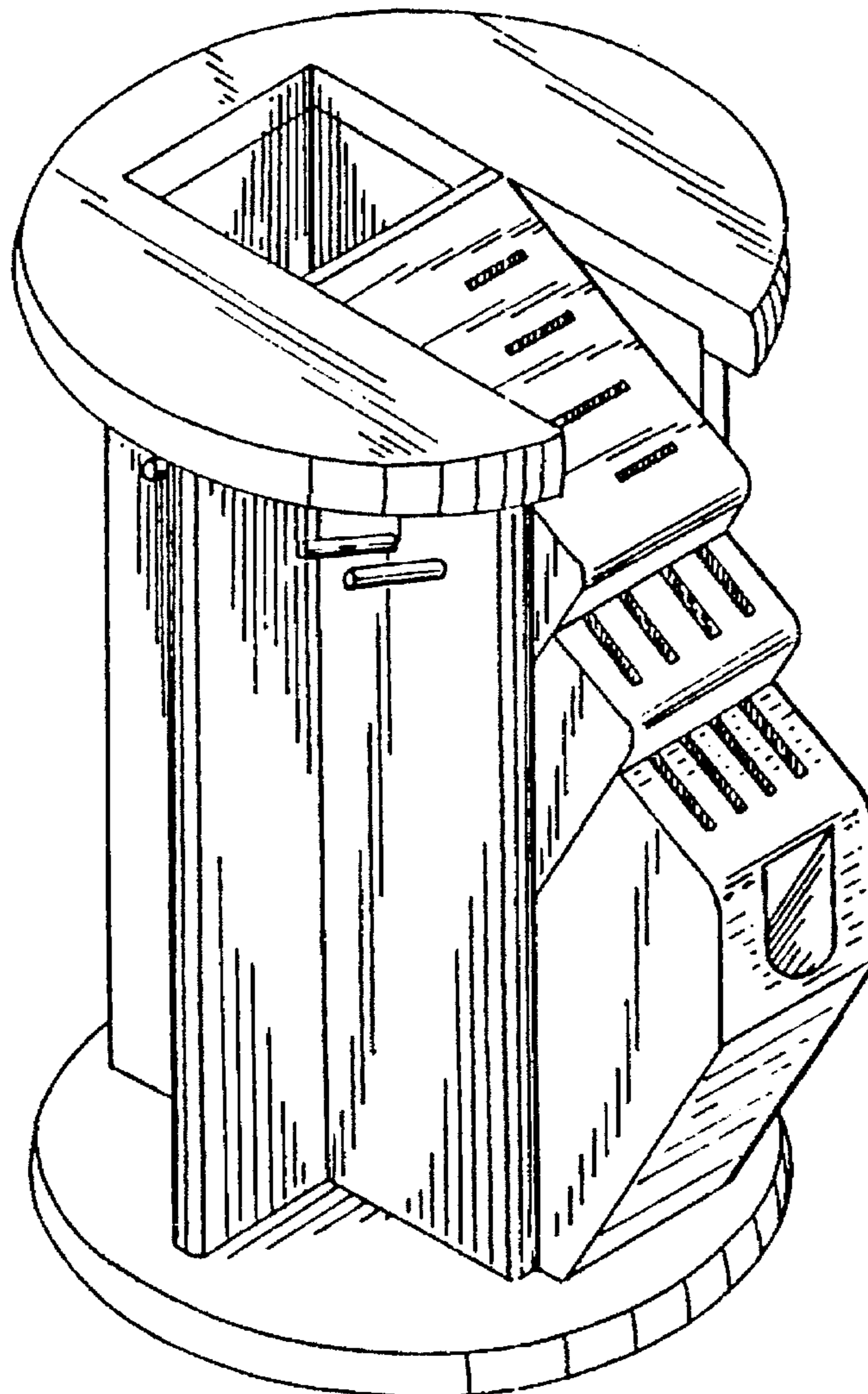

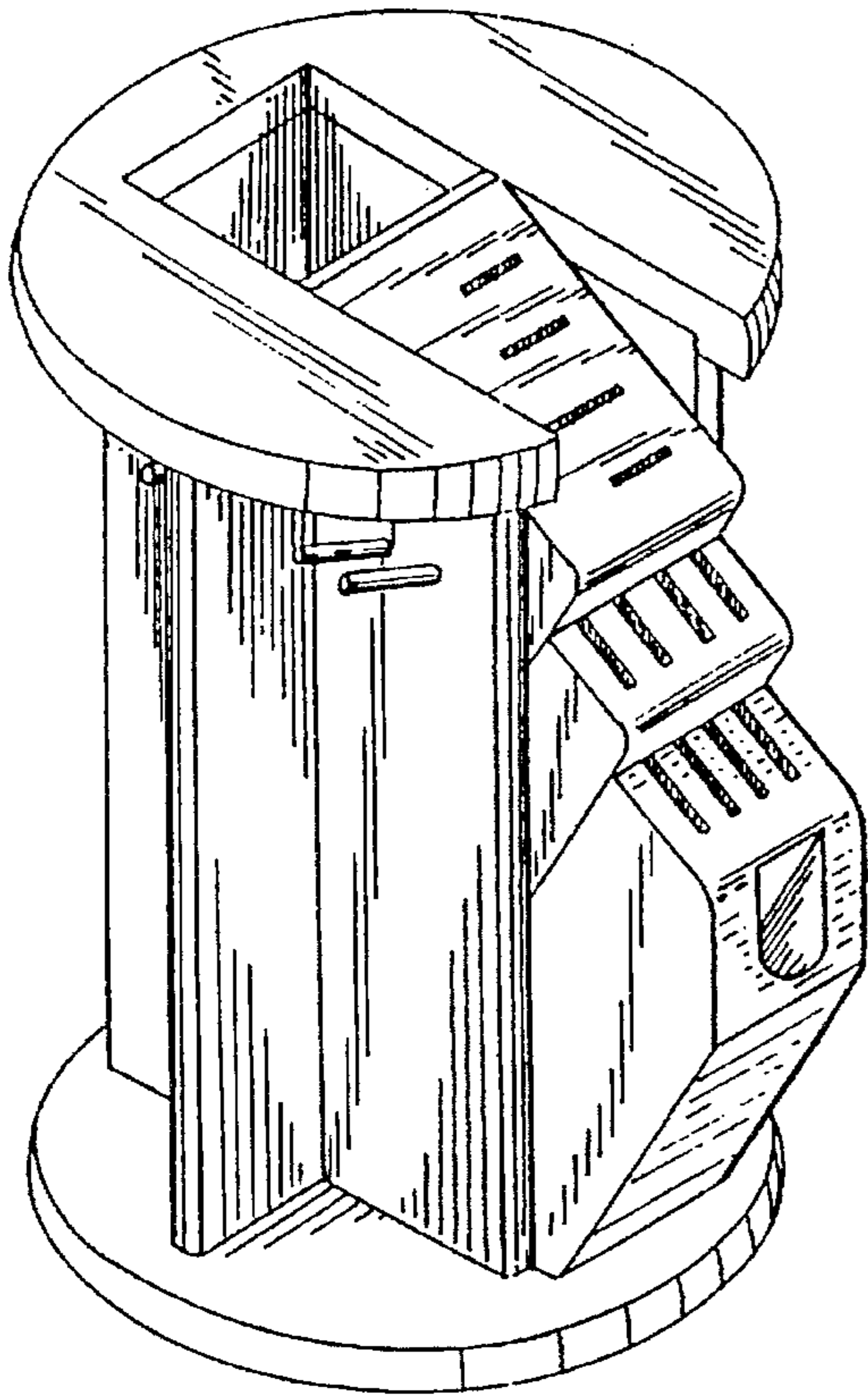

FIG. 1

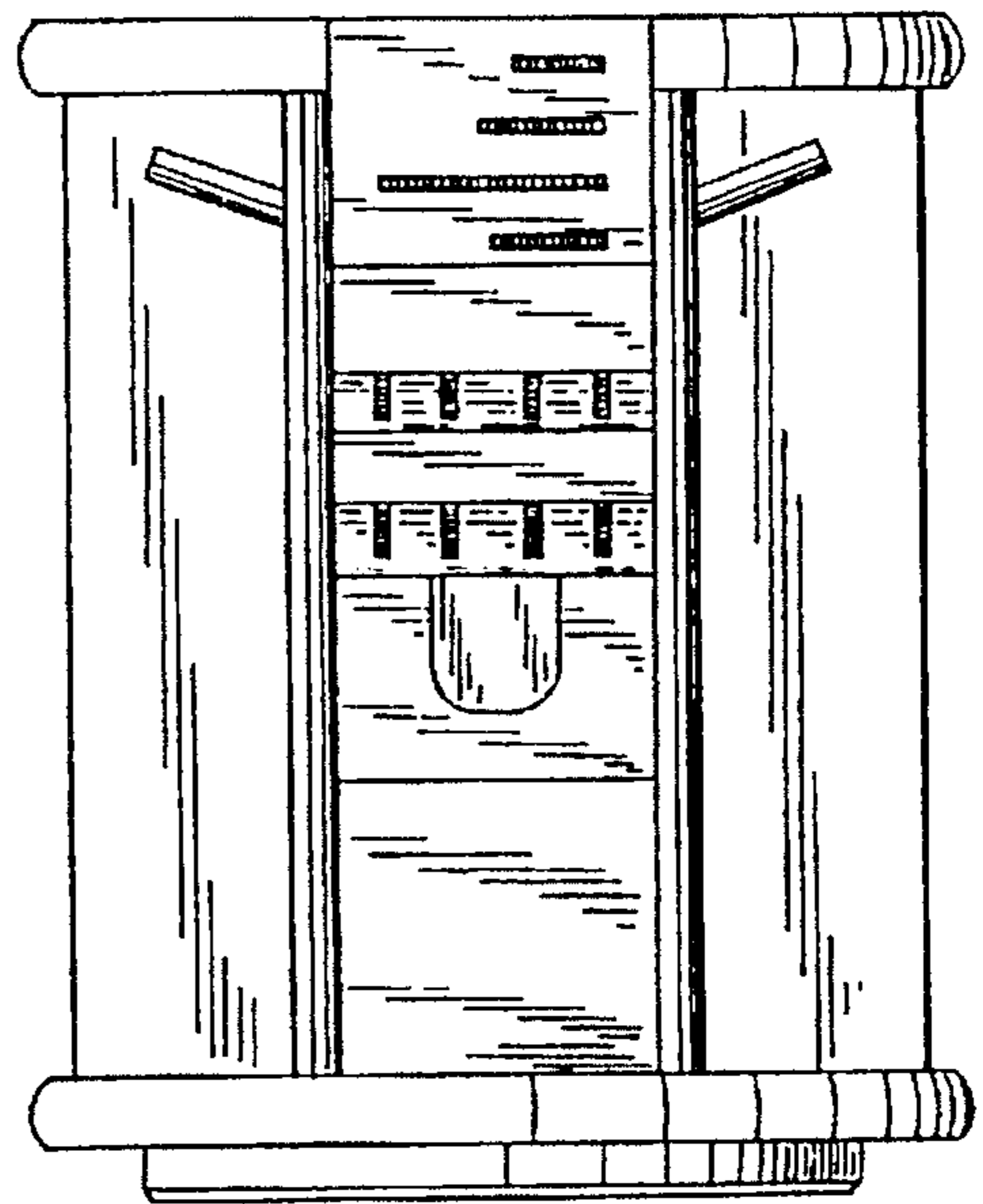

FIG. 2

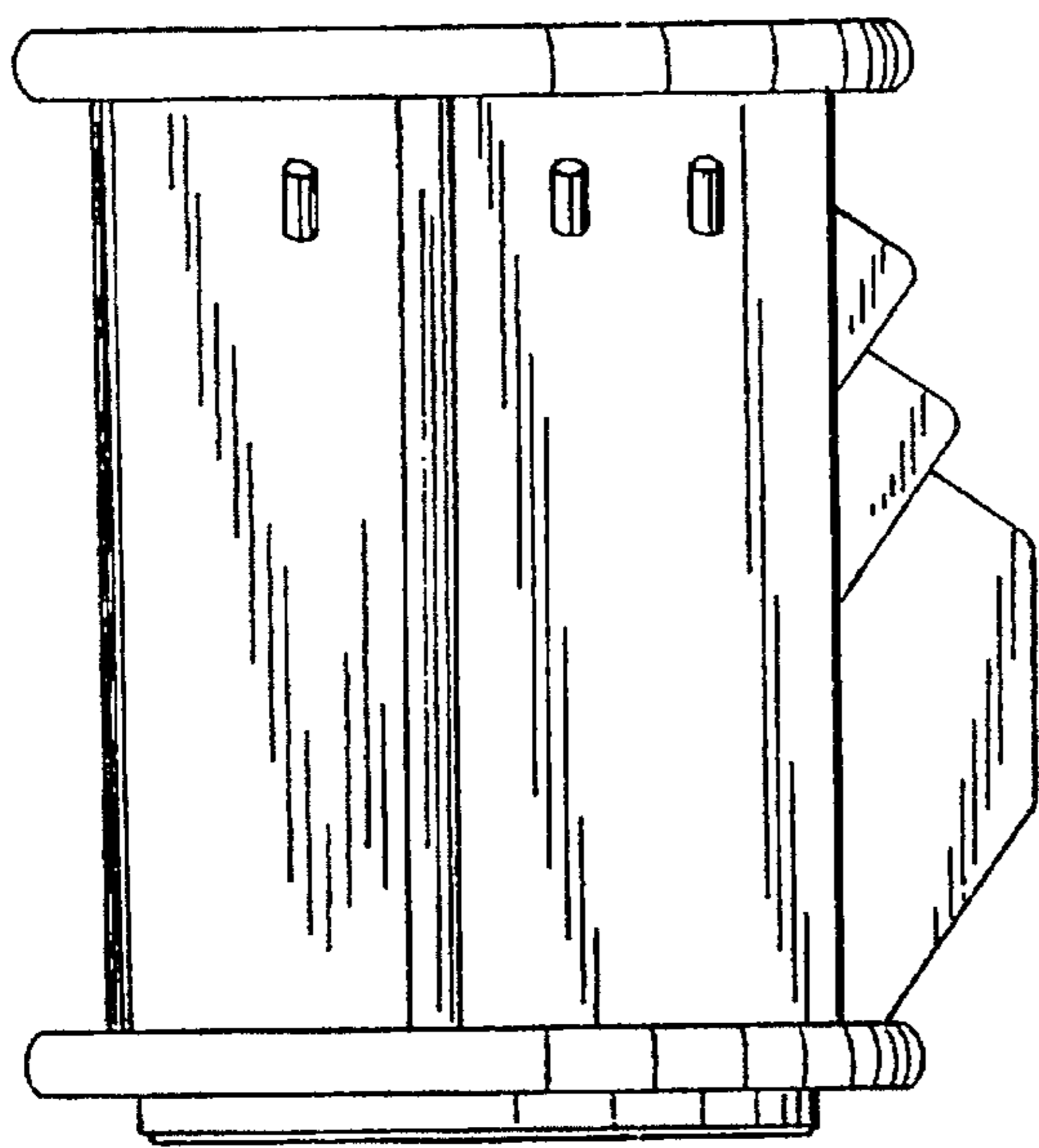

FIG. 3

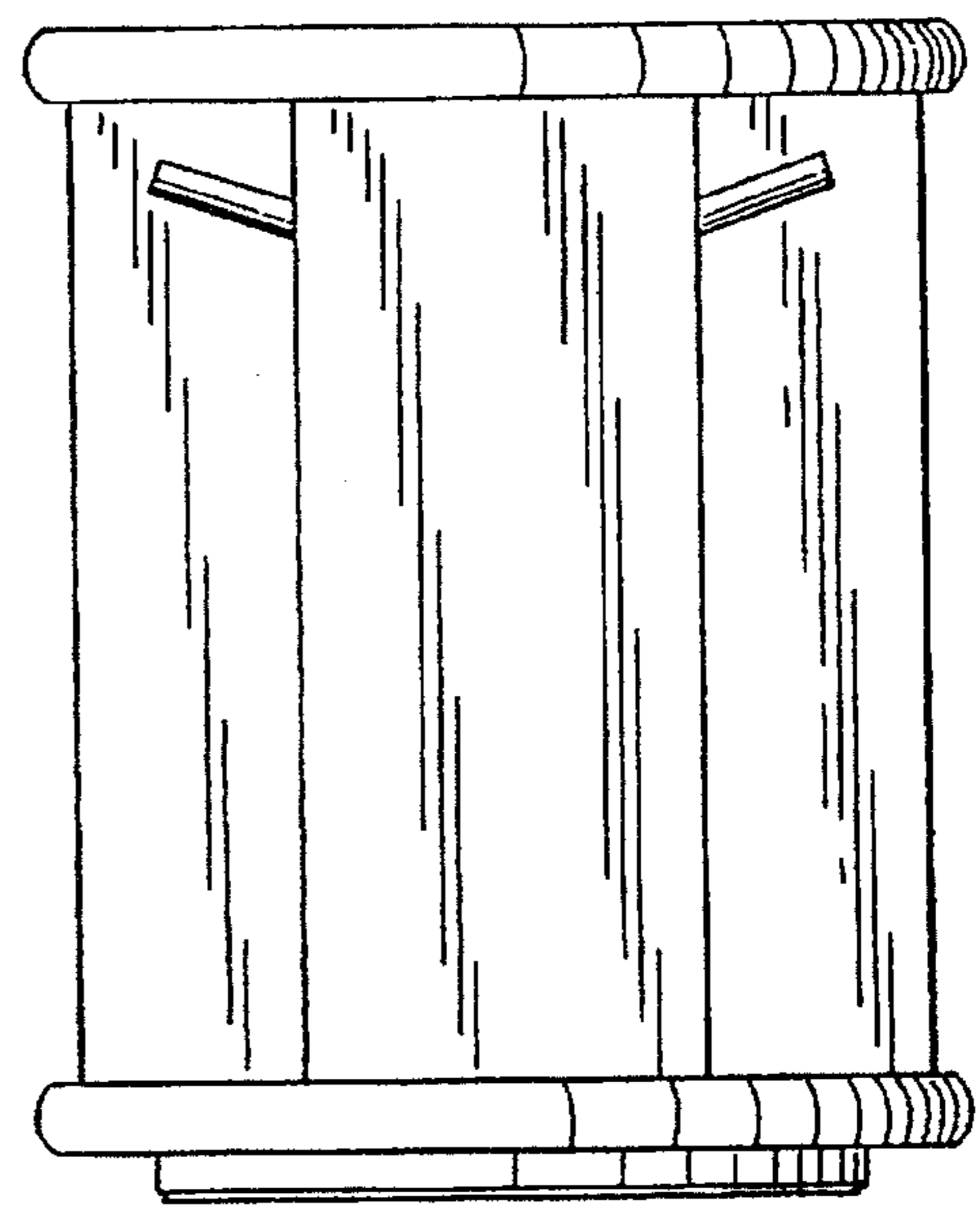

FIG. 4

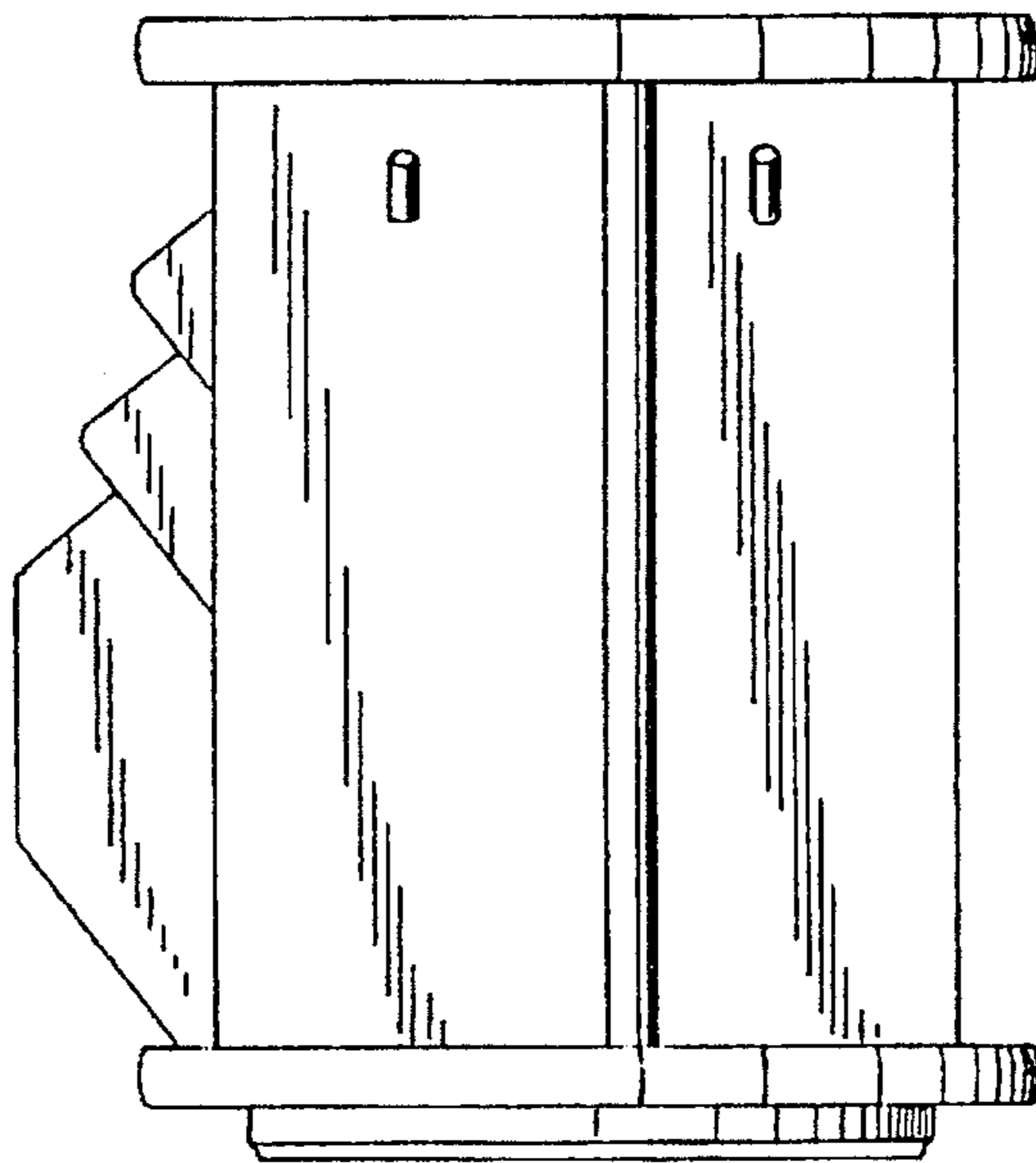

FIG. 5

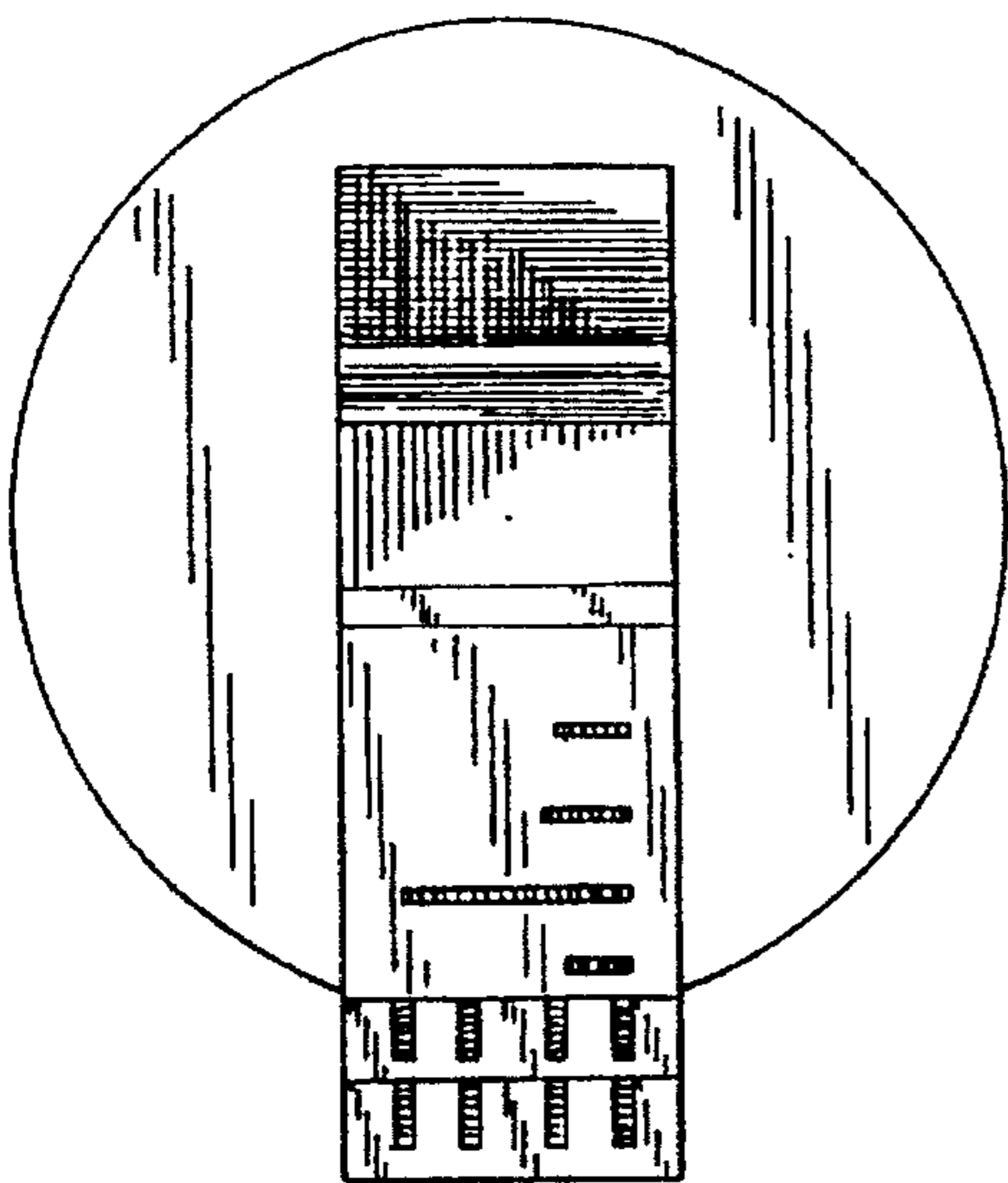

FIG. 6

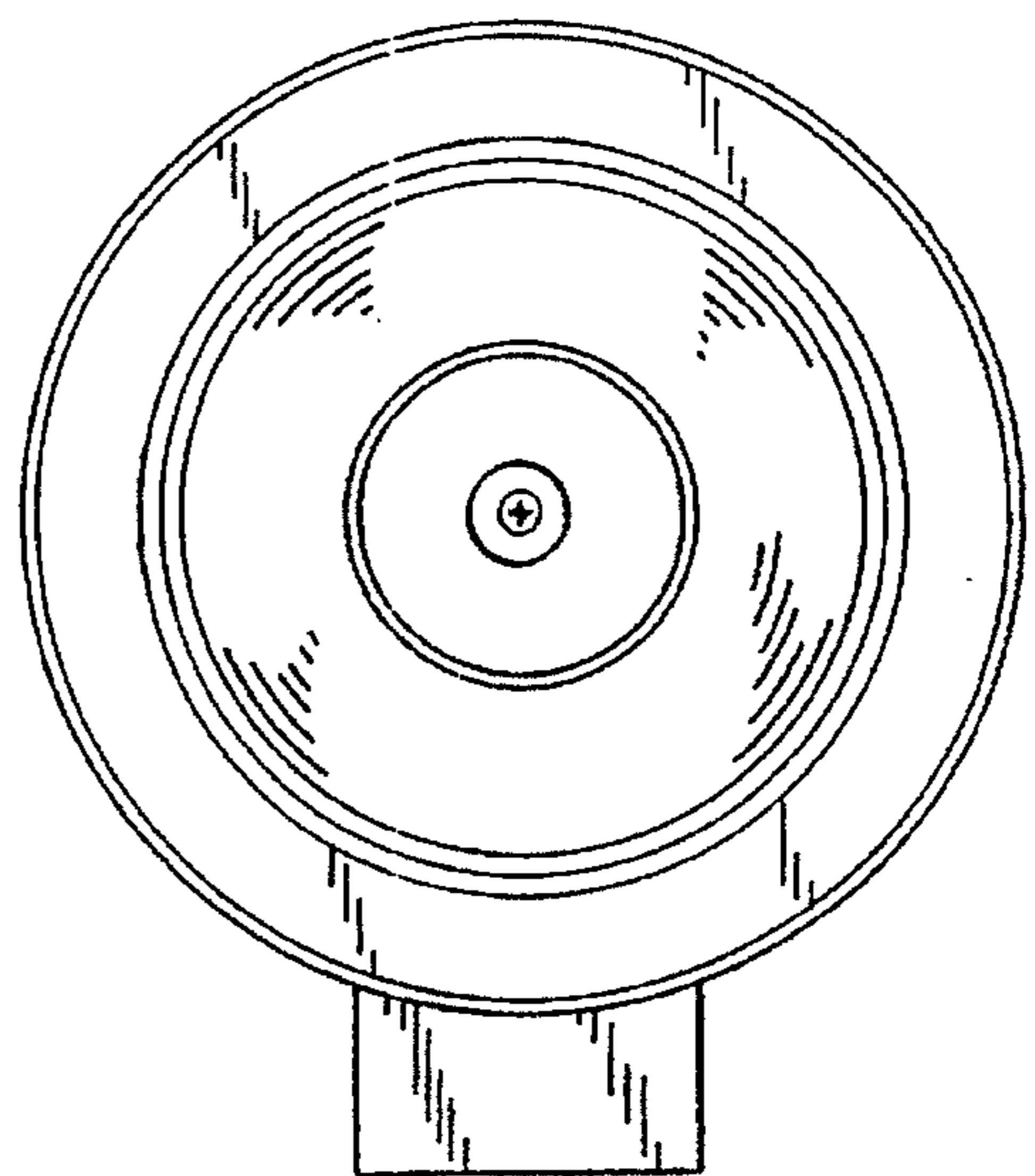

FIG. 7