



US00D380351S

United States Patent [19]

Jeppesen et al.

[11] Patent Number: **Des. 380,351**

[45] Date of Patent: ****Jul. 1, 1997**

[54] **CONDIMENT SHAKER**

[75] Inventors: **Hanne Dalsgaard Jeppesen, Holte; Jakob Heiberg, Charlottenlund; Stig Lillelund, Gentofte, all of Denmark**

[73] Assignee: **Dart Industries Inc., Orlando, Fla.**

[**] Term: **14 Years**

[21] Appl. No.: **49,656**

[22] Filed: **Feb. 15, 1996**

[51] LOC (6) Cl. **07-06**

[52] U.S. Cl. **D7/597; D9/509**

[58] Field of Search **D7/590-597, 679; 222/142.1-142.9; 241/168; D9/500, 503, 509, 511, 513**

[56] **References Cited**

U.S. PATENT DOCUMENTS

1,439,259	12/1922	Pasnik	D7/597 X
2,937,793	5/1960	Cornelius	D7/597 X
3,664,554	5/1972	Shiozawa	D7/597 X

Primary Examiner—Terry A. Wallace
Attorney, Agent, or Firm—John A. Doninger

[57] **CLAIM**

The ornamental design for a condiment shaker, as shown and described.

DESCRIPTION

FIG. 1 is a top, front and side perspective view of a condiment shaker showing our new design;
 FIG. 2 is a top, front and side perspective view thereof with the seal open;
 FIG. 3 is a top plan view thereof;
 FIG. 4 is a bottom plan view thereof;
 FIG. 5 is a front elevation view thereof;
 FIG. 6 is a rear elevation view thereof;
 FIG. 7 is a right side elevation view thereof;
 FIG. 8 is a left side elevation view thereof;
 FIG. 9 is a cross-section thereof taken on line 9—9 in FIG. 3; and,
 FIG. 10 is a cross-section thereof taken on line 10—10 in FIG. 3.

1 Claim, 3 Drawing Sheets

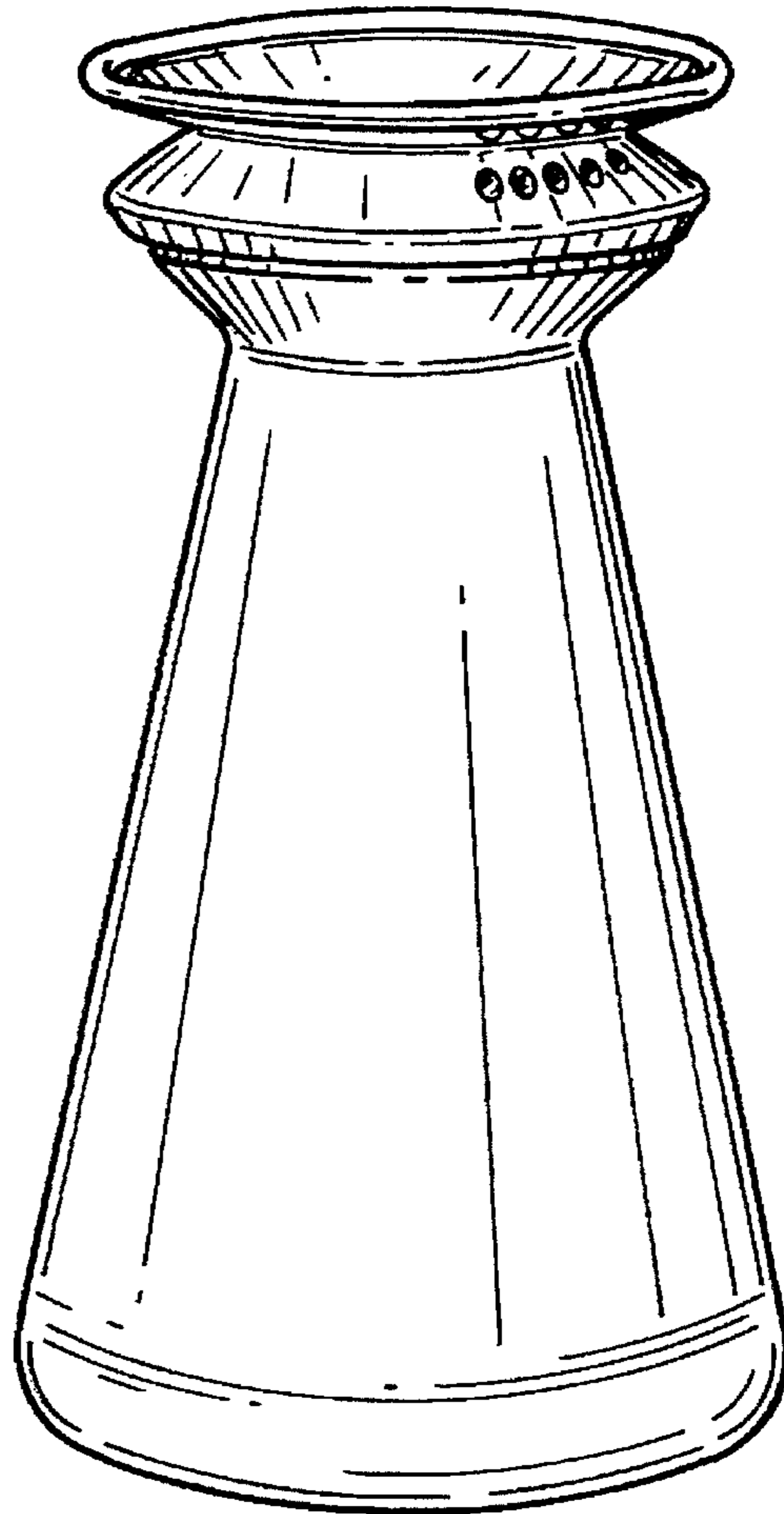
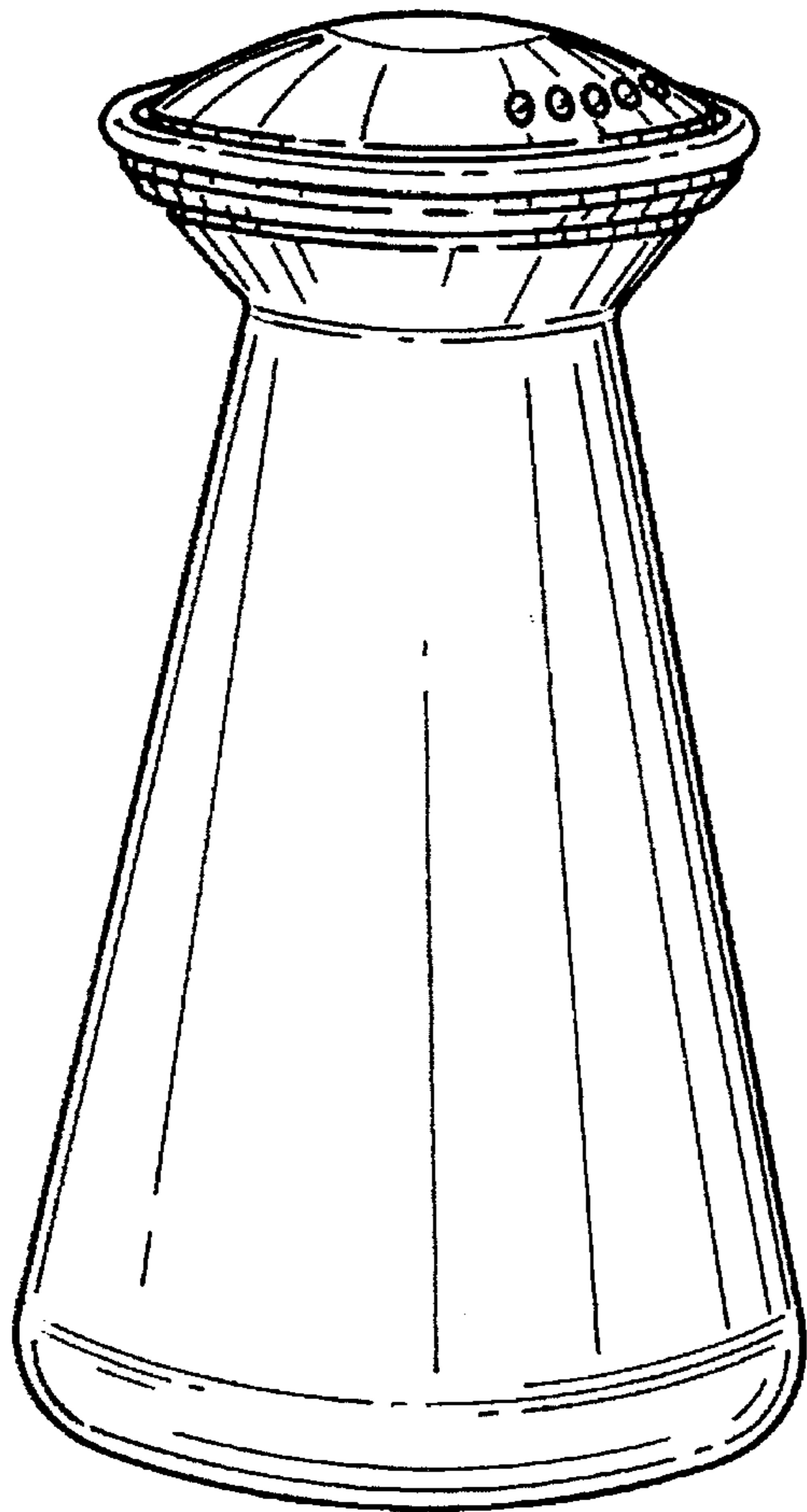

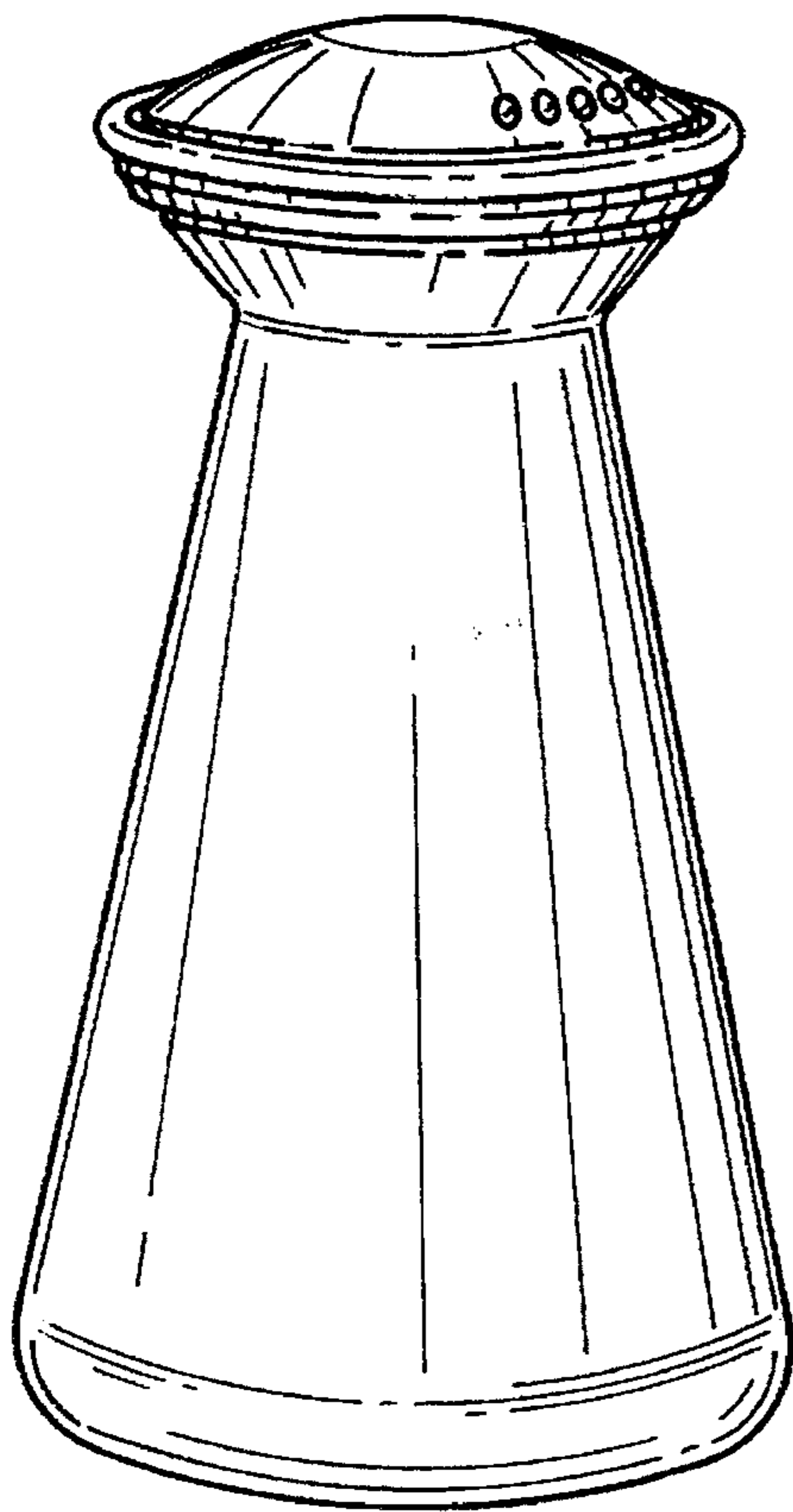

FIG. 1

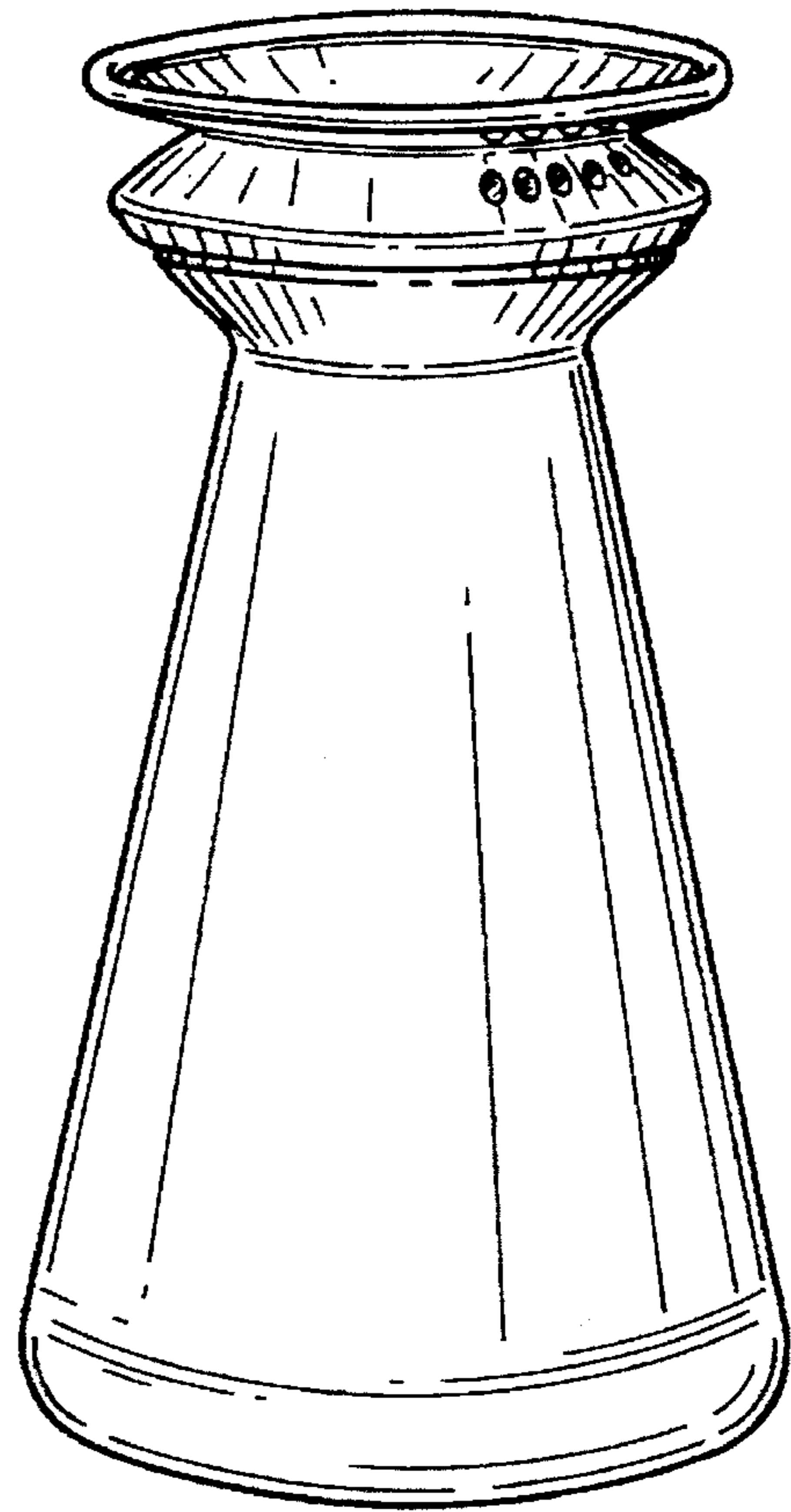

FIG. 2

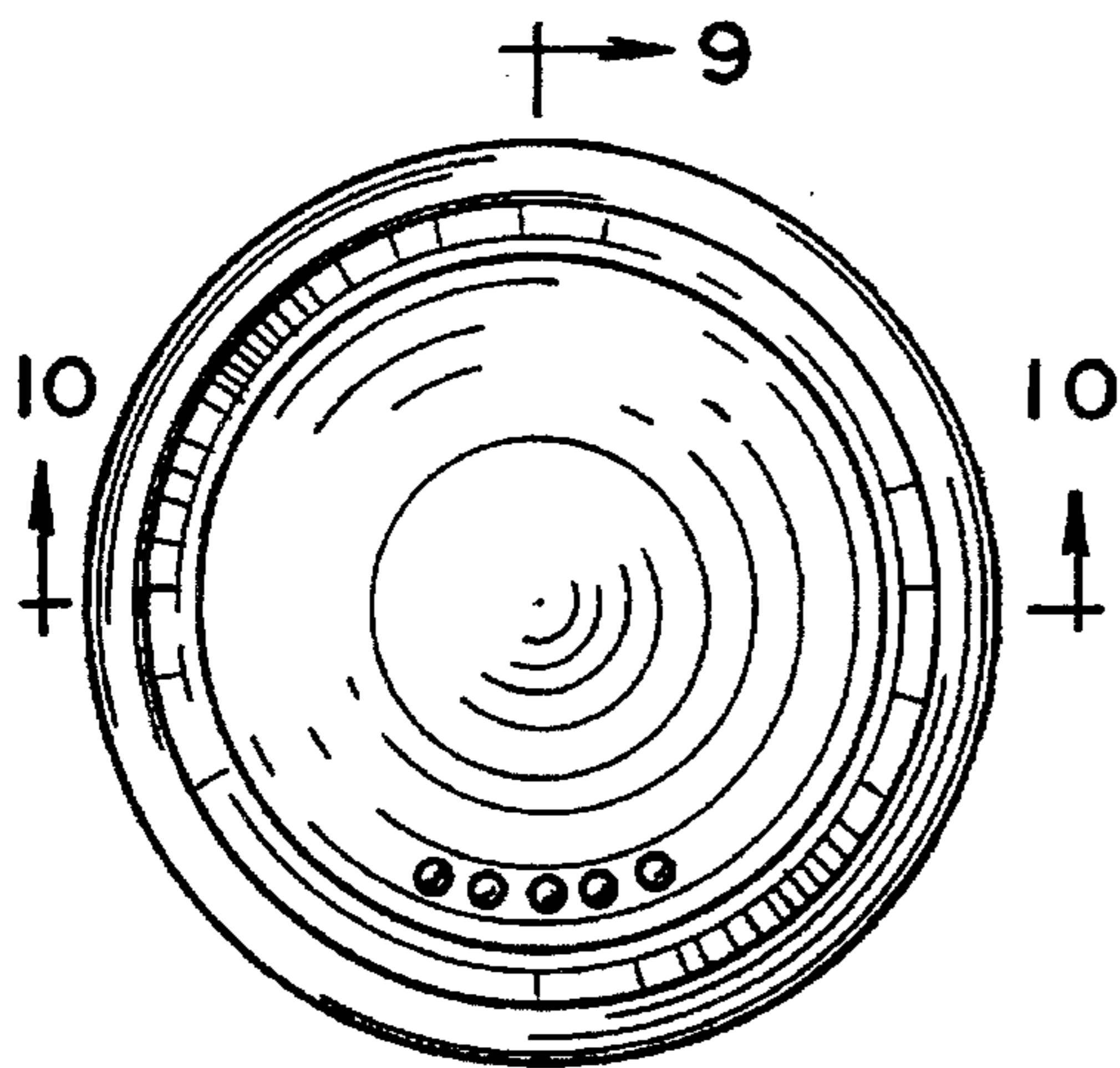

FIG. 3

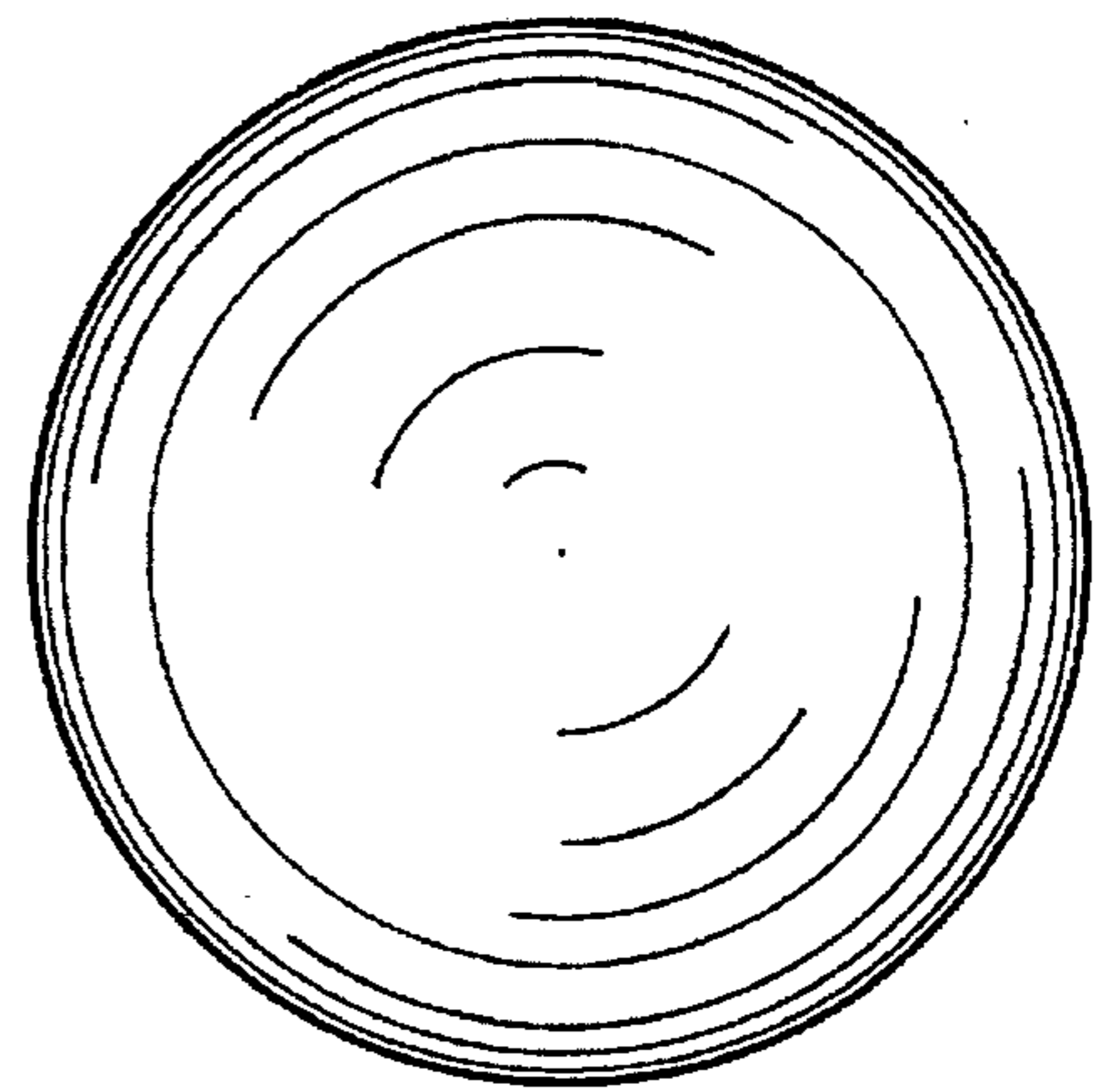

FIG. 4

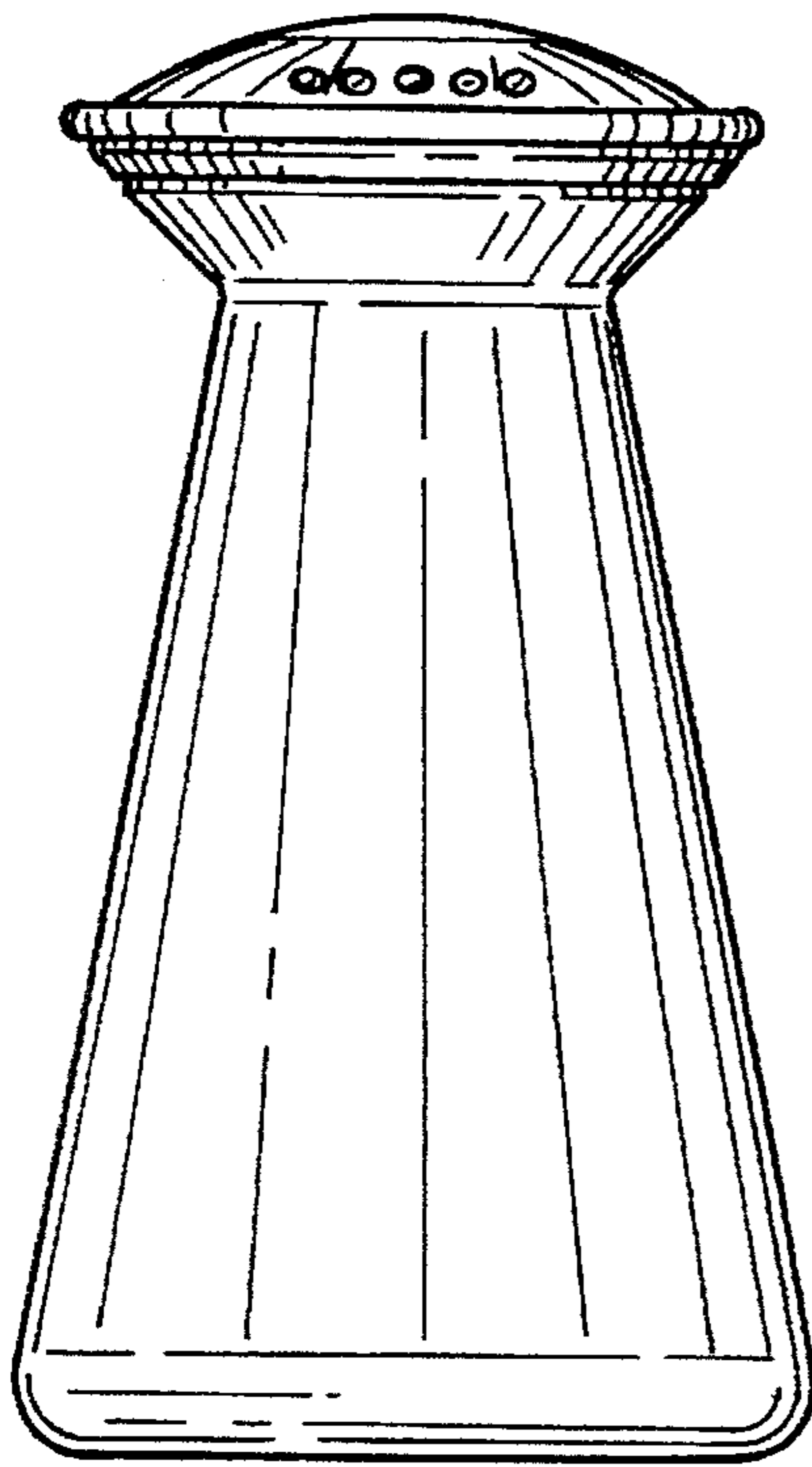

FIG. 5

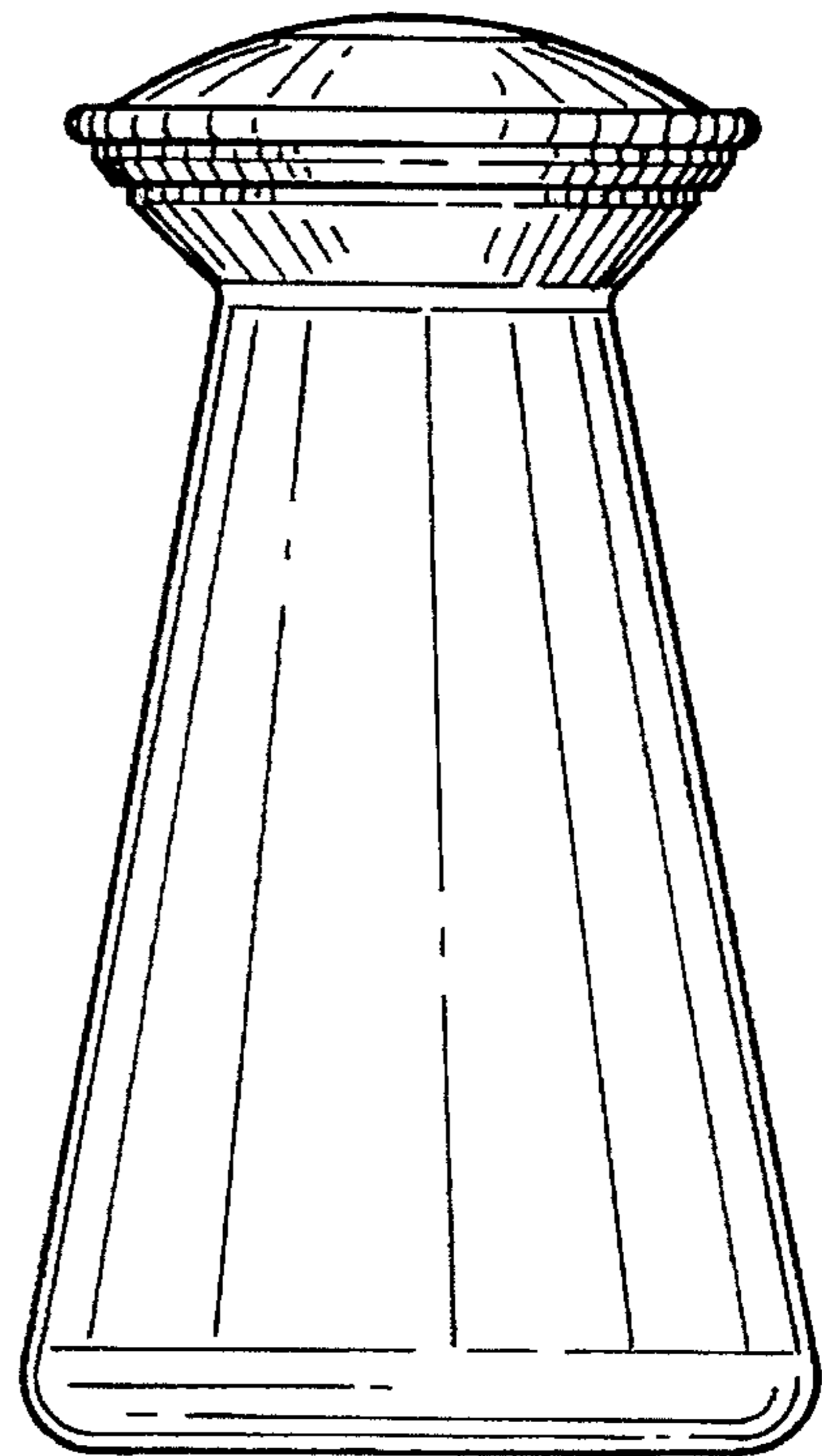

FIG. 6

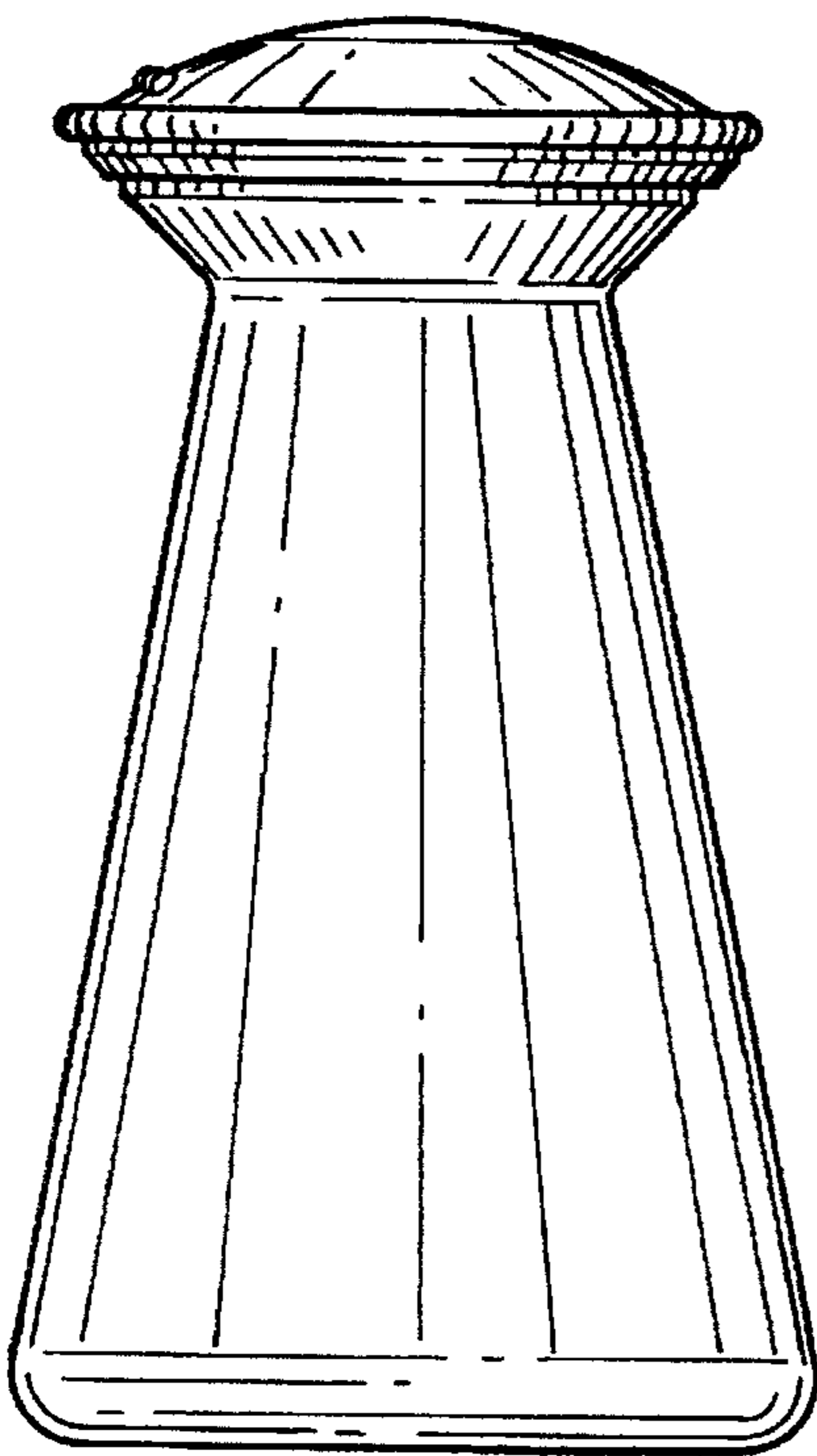

FIG. 7

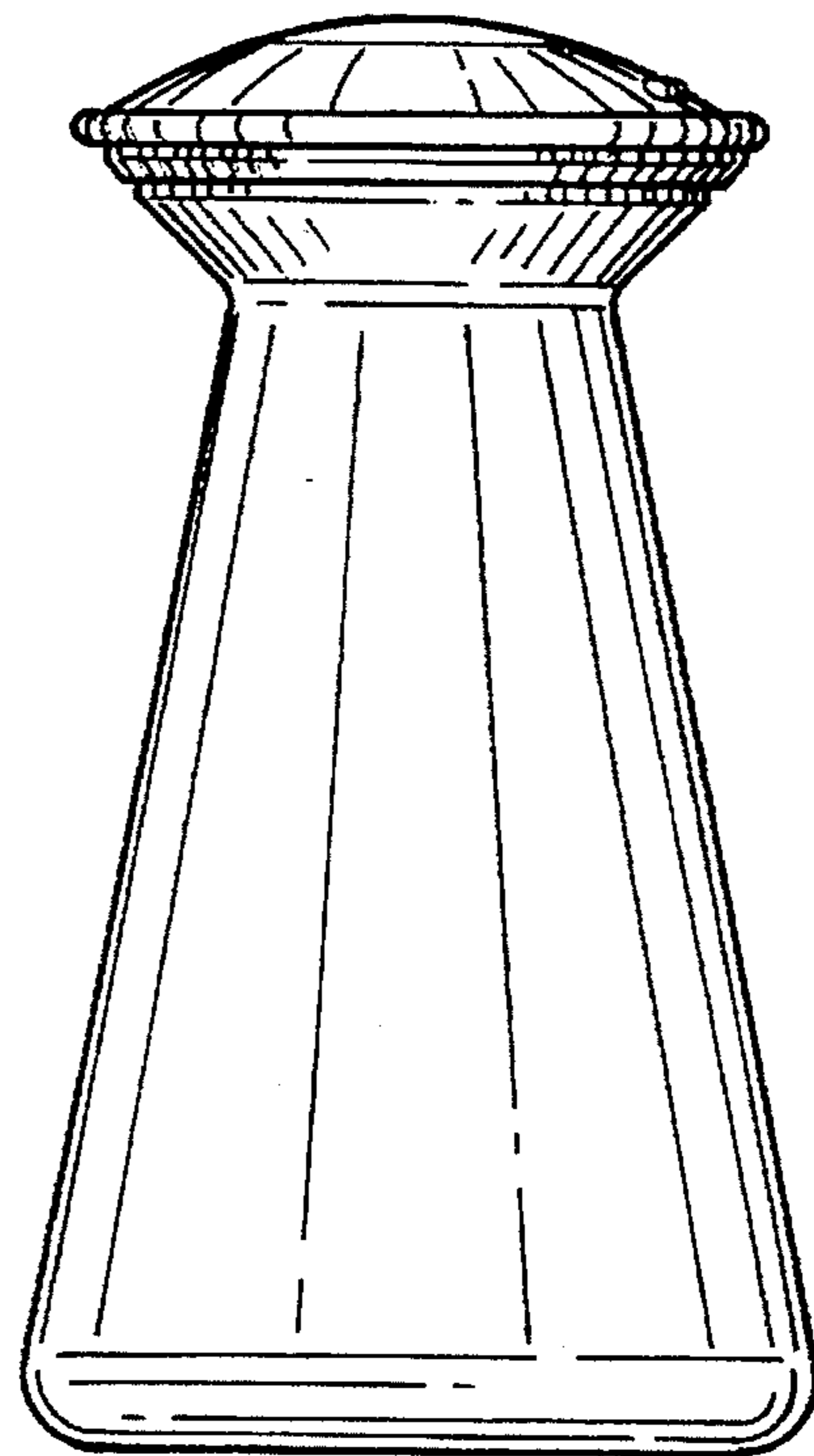

FIG. 8

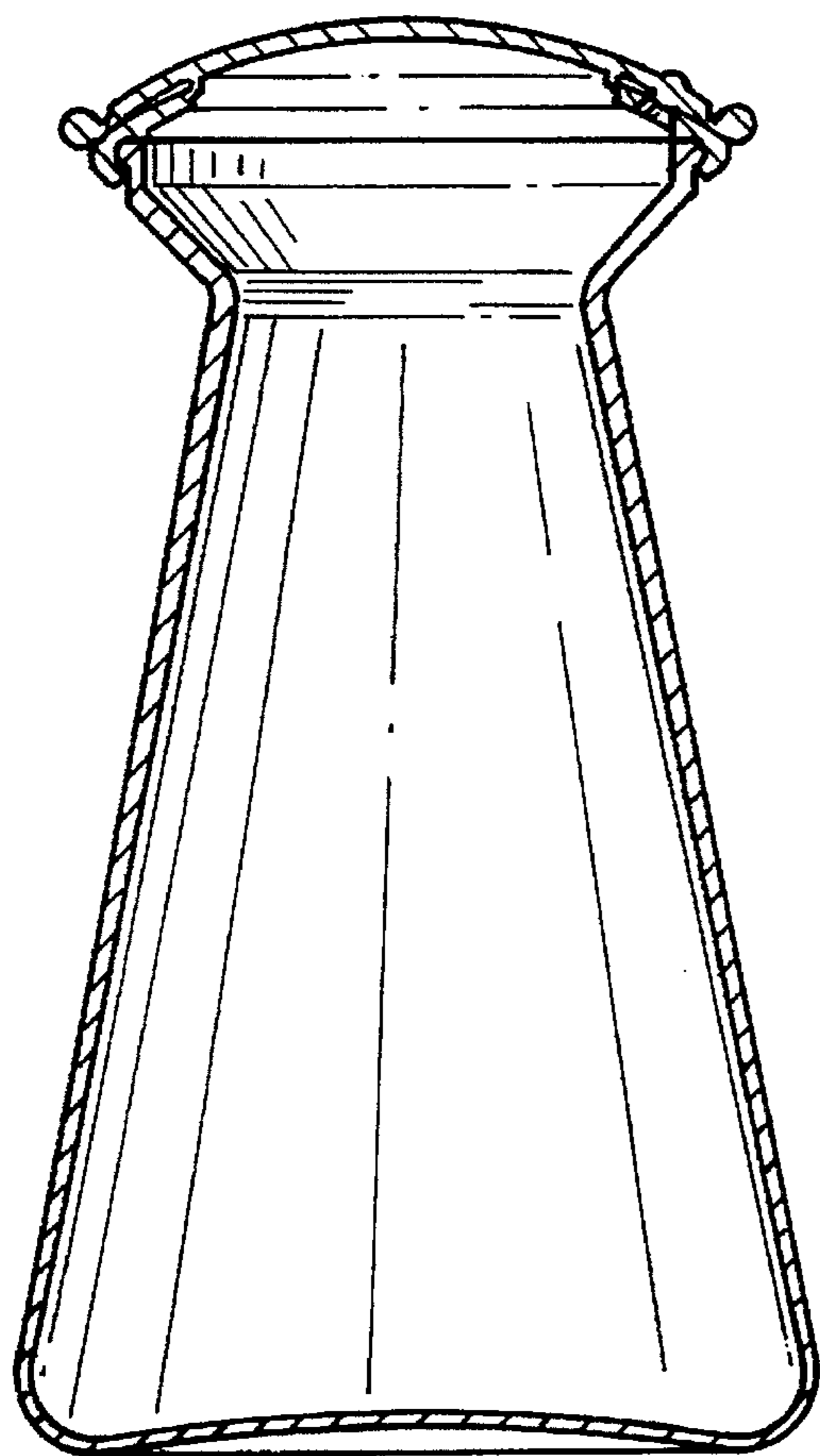

FIG. 9

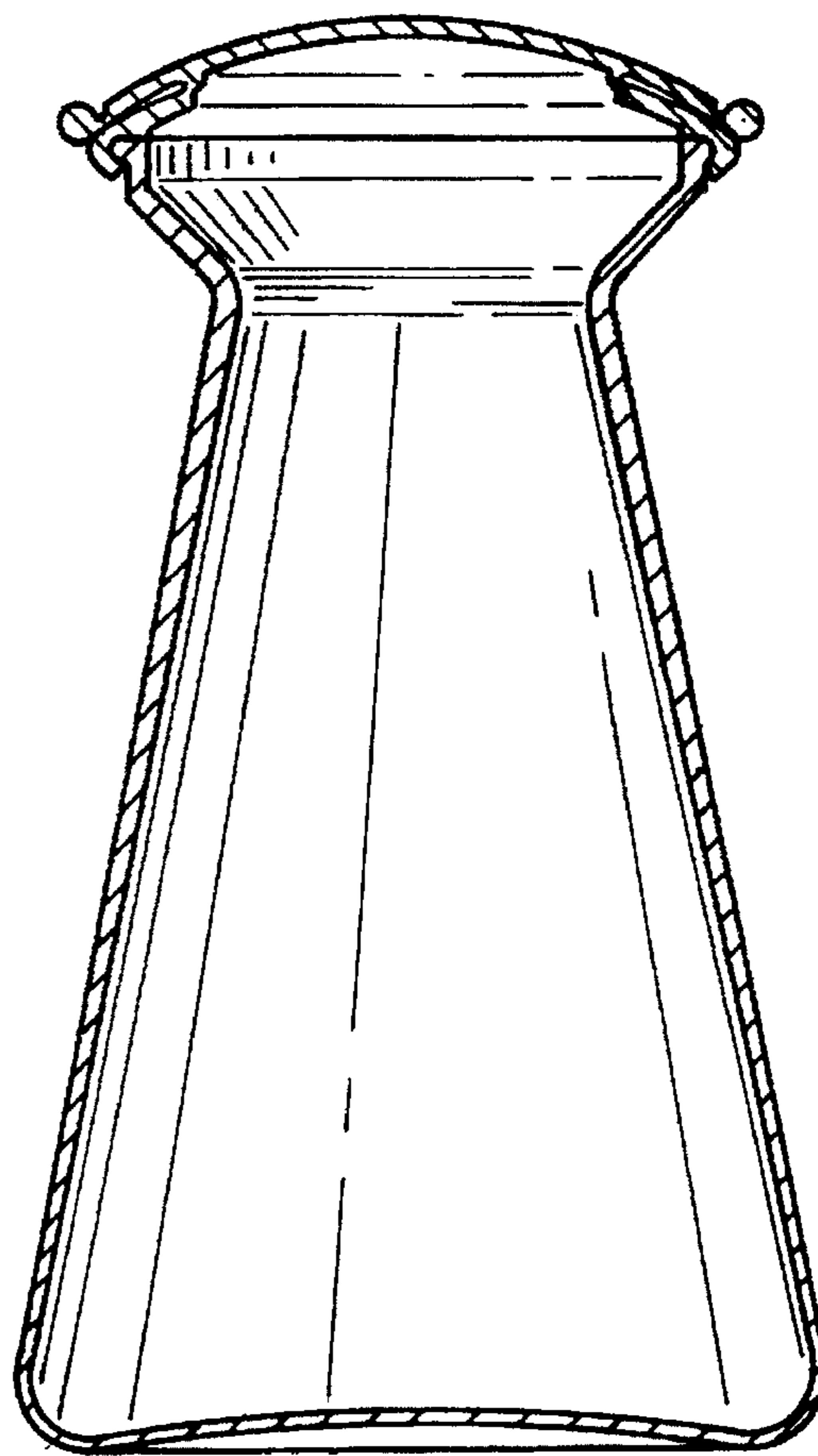

FIG. 10