



US00D380299S

United States Patent [19]

Schlaeger et al.

[11] Patent Number: **Des. 380,299**

[45] Date of Patent: ****Jul. 1, 1997**

[54] STACKING CONTAINER

[76] Inventors: **James Schlaeger**, 2725 Lexington Ave., Roseville, Minn. 55113; **George Holgate**, 3228 Leyland Trail, St. Paul, Minn. 55125

[**] Term: **14 Years**

[21] Appl. No.: **28,898**

[22] Filed: **Sep. 26, 1994**

[51] LOC (6) Cl. **03-01**

[52] U.S. Cl. **D3/310; D9/347**

[58] Field of Search D3/304, 305, 307-314; D9/347, 432, 424; D34/1; 206/509, 512, 557, 561; 217/7; 220/524, 553, 555, 674, 500

[56] References Cited

U.S. PATENT DOCUMENTS

D. 326,341	5/1992	Frauhiger	D34/1
2,640,621	6/1953	Mokin	220/674
3,117,688	1/1964	Walstad et al.	217/7
3,580,475	5/1971	Mobley	206/509
5,011,018	4/1991	Keffeler	220/524 X
5,178,295	1/1993	Crumrine et al.	220/555 X

Primary Examiner—B. J. Bullock

Assistant Examiner—Richelle Shelton

Attorney, Agent, or Firm—D. L. Tschida

[57] CLAIM

The ornamental design for a stacking container, as shown and described.

DESCRIPTION

FIG. 1 is a perspective drawing of a first embodiment of our stacking container;

FIG. 2 is a perspective drawing of top tray thereof;

FIG. 3 is a perspective drawing of the bottom tray thereof;

FIG. 4 is a top plan view of the top tray thereof;

FIG. 5 is a top plan view of the bottom tray thereof;

FIG. 6 is a bottom plan view of the top and bottom trays of the first and second embodiments;

FIG. 7 is a front elevation view of the top and bottom trays of the first and second embodiments;

FIG. 8 is a right side elevation view of the top and bottom trays of the first and second embodiments, the left side view being a mirror image;

FIG. 9 is a perspective drawing of a second embodiment of our stacking container;

FIG. 10 is a top plan view of the top tray of the second embodiment; and,

FIG. 11 is a top plan view of the bottom tray of the second embodiment.

The trays in FIGS. 2-8, 10 and 11 are shown separately for clarity of illustration.

1 Claim, 11 Drawing Sheets

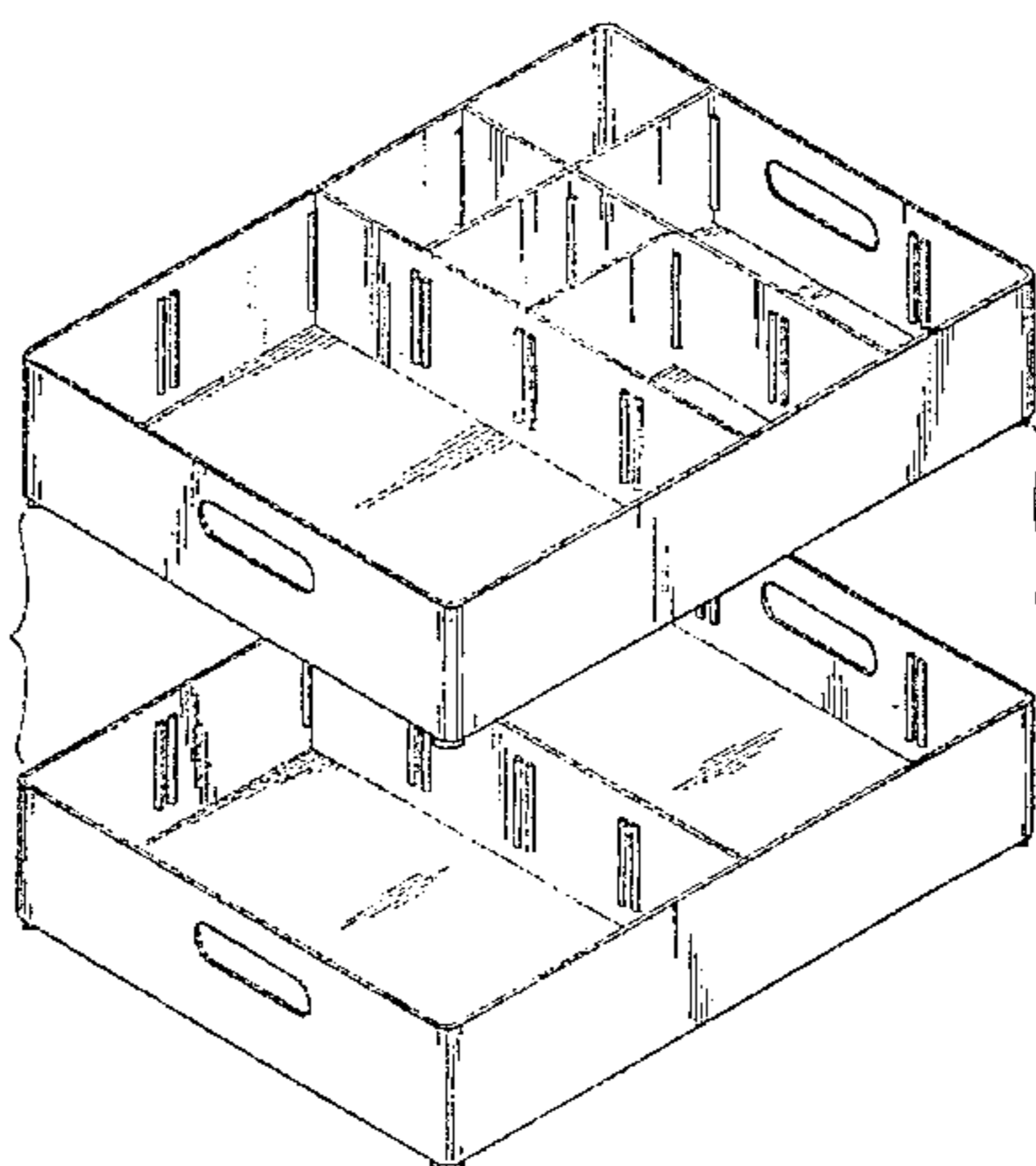
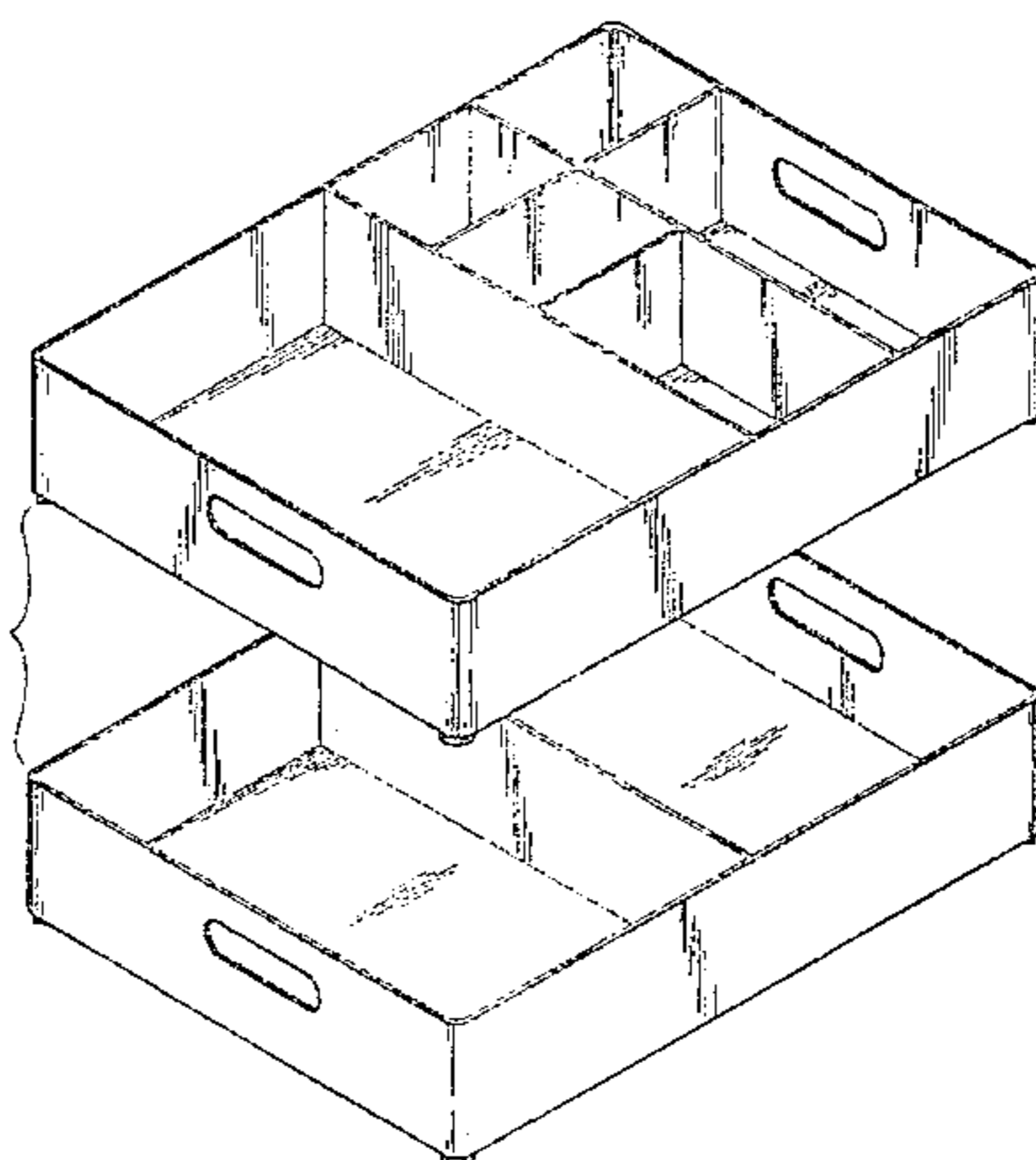

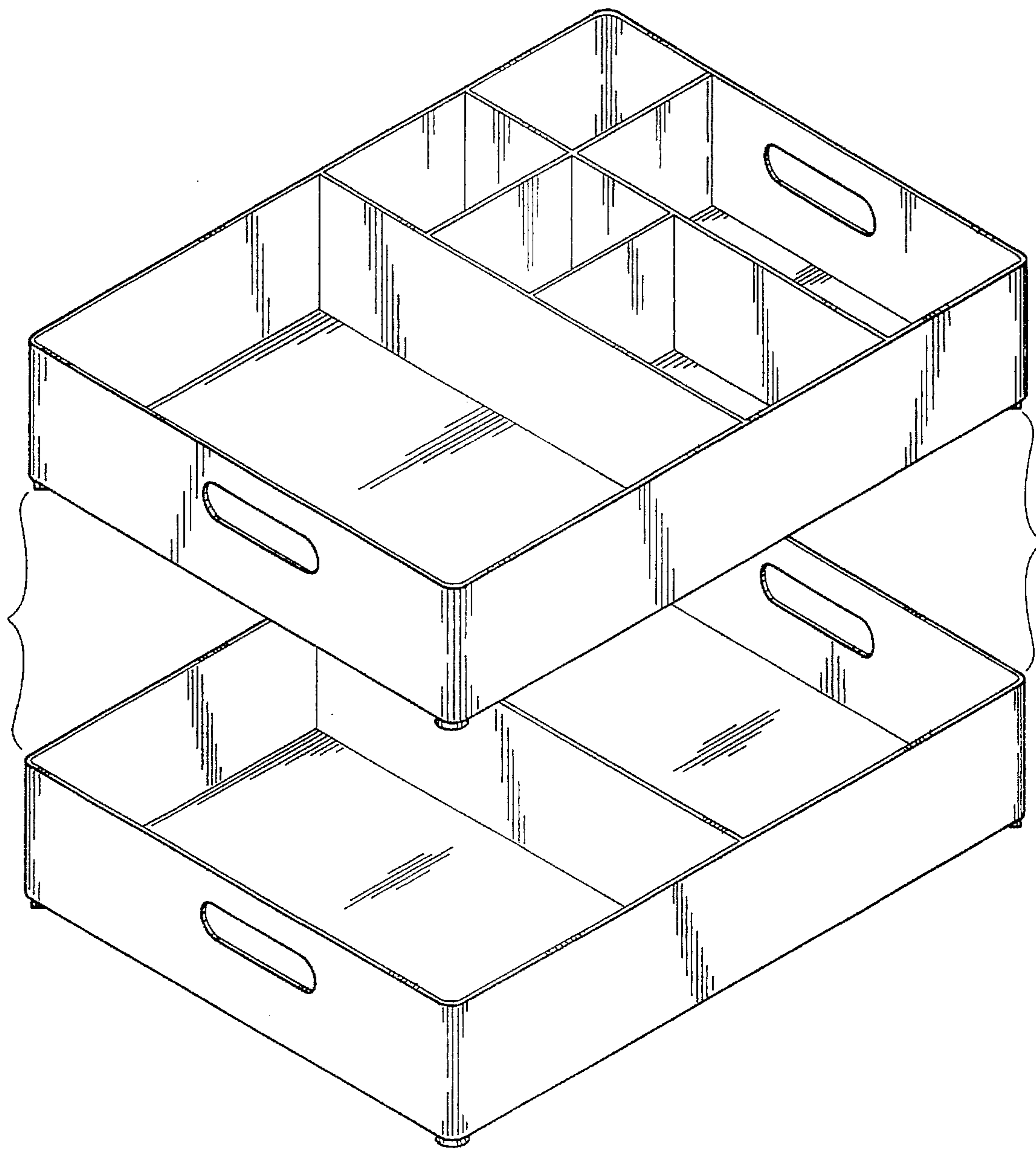

FIG. 1

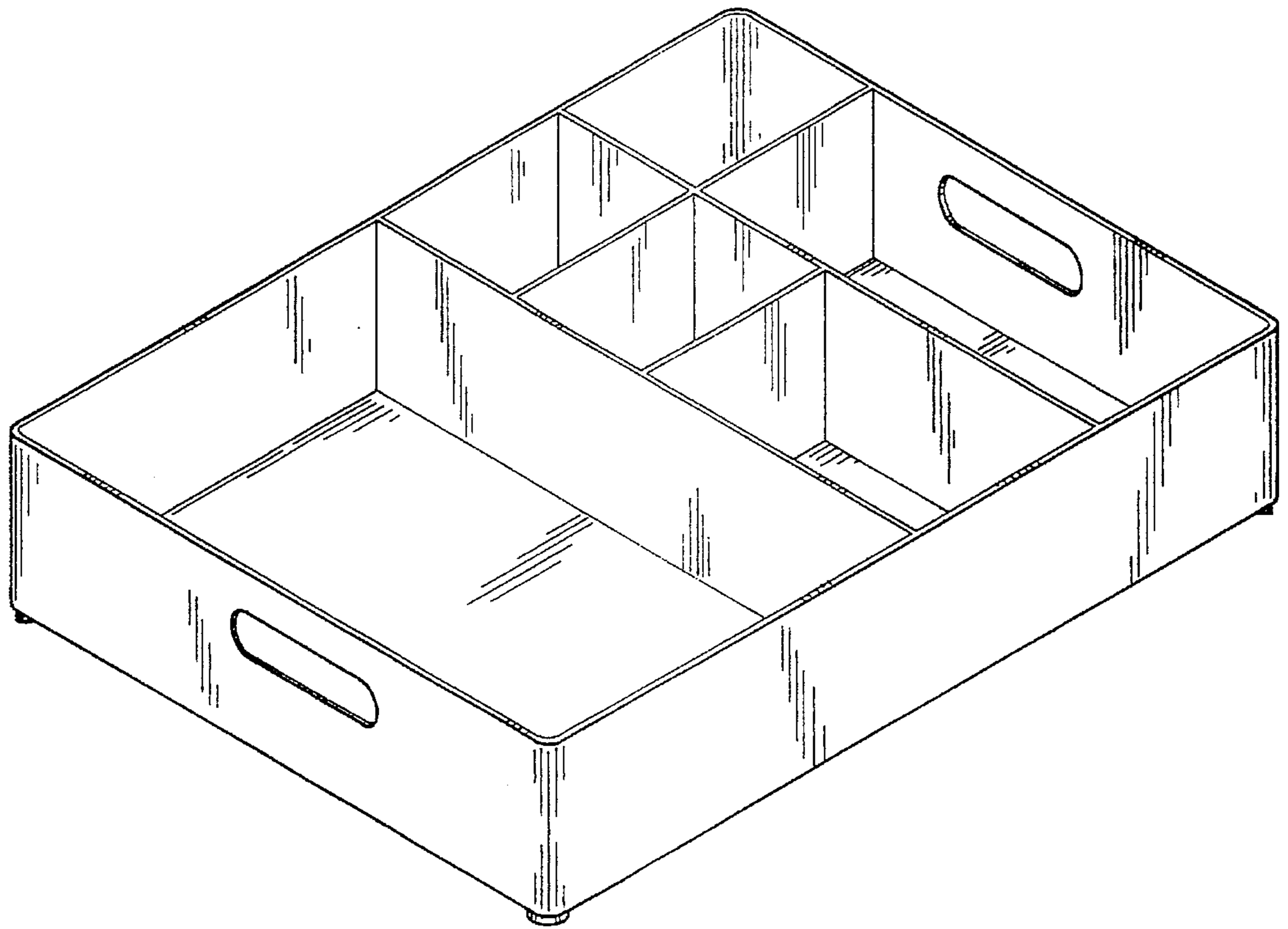

FIG. 2

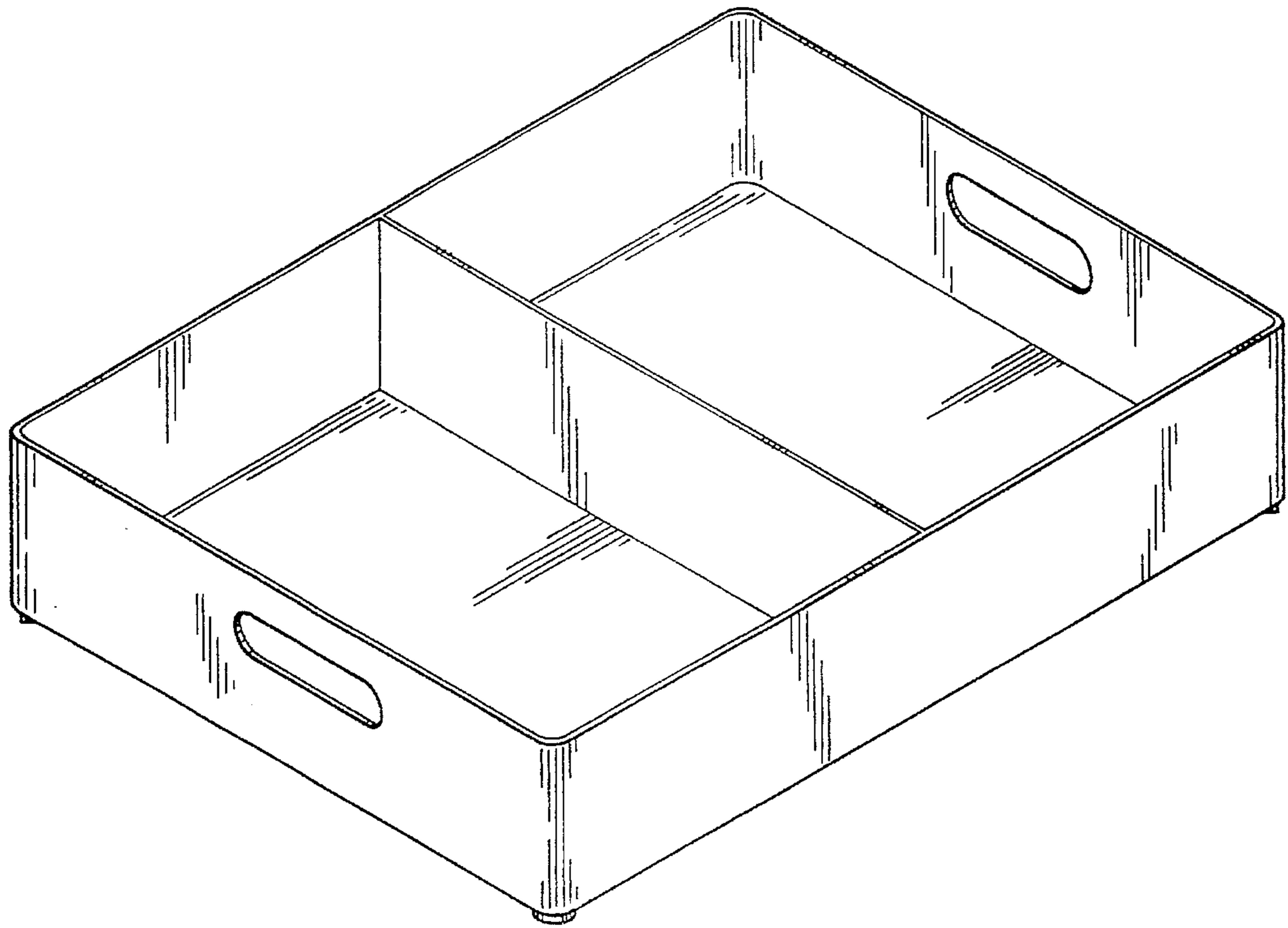

FIG. 3

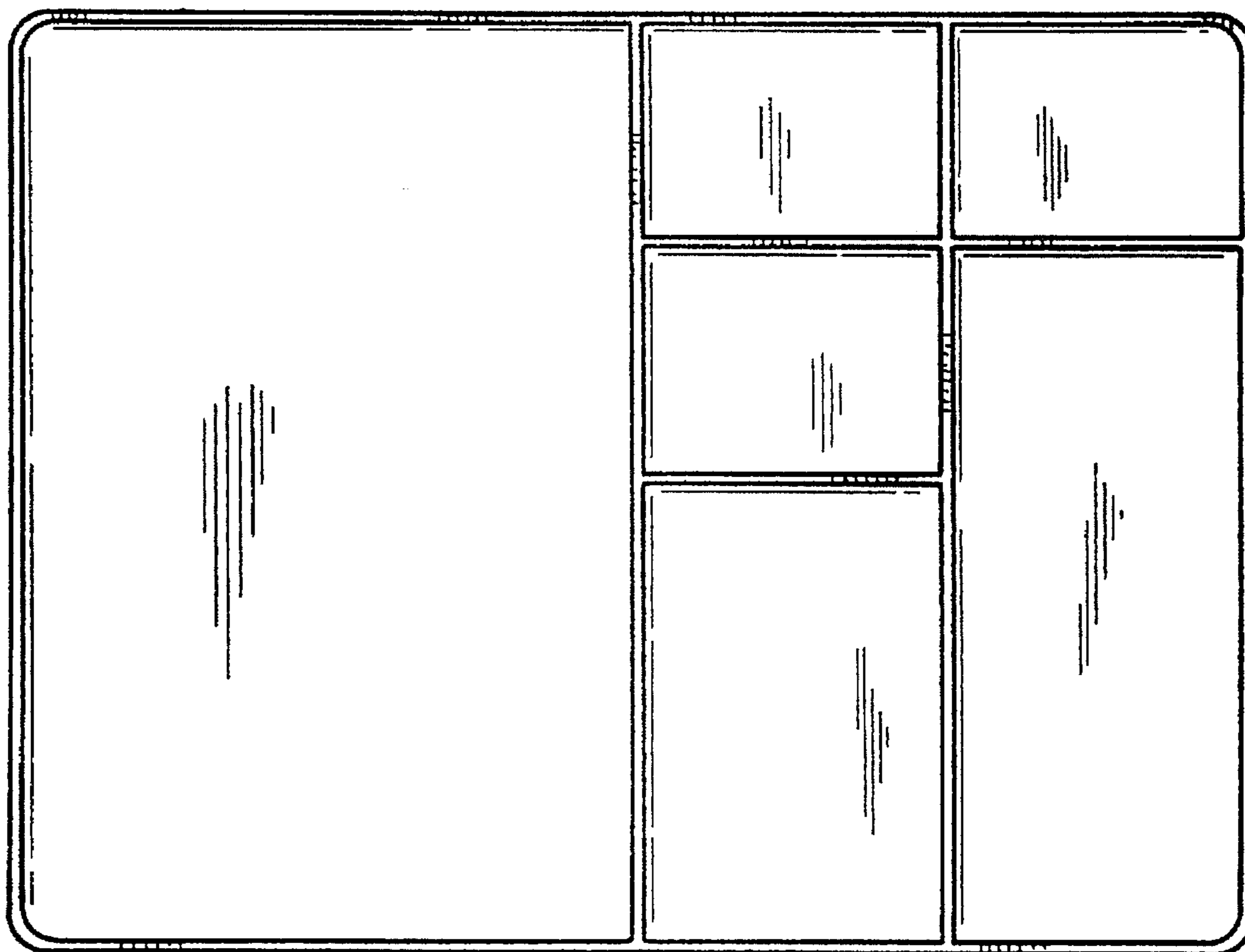

FIG. 4

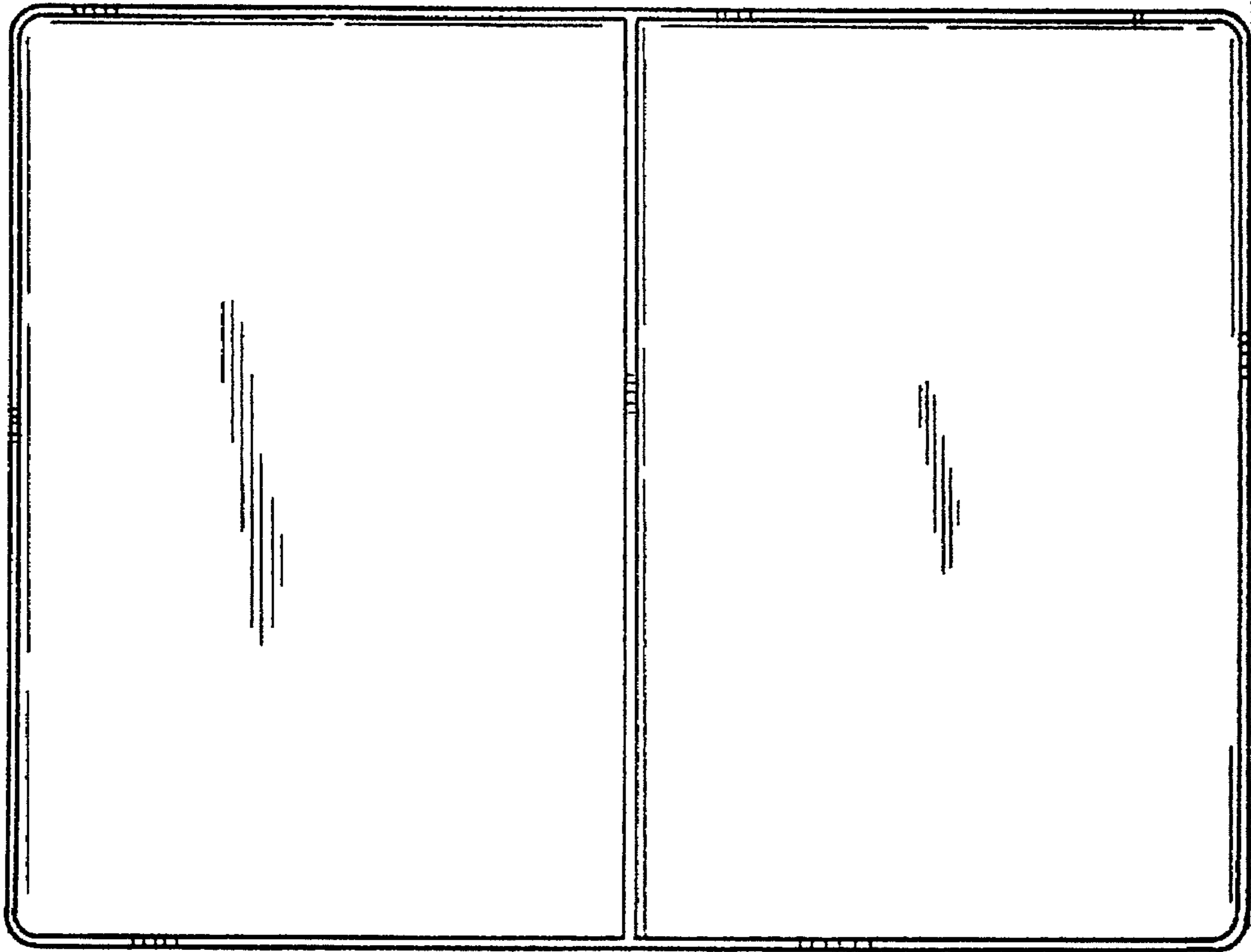

FIG. 5

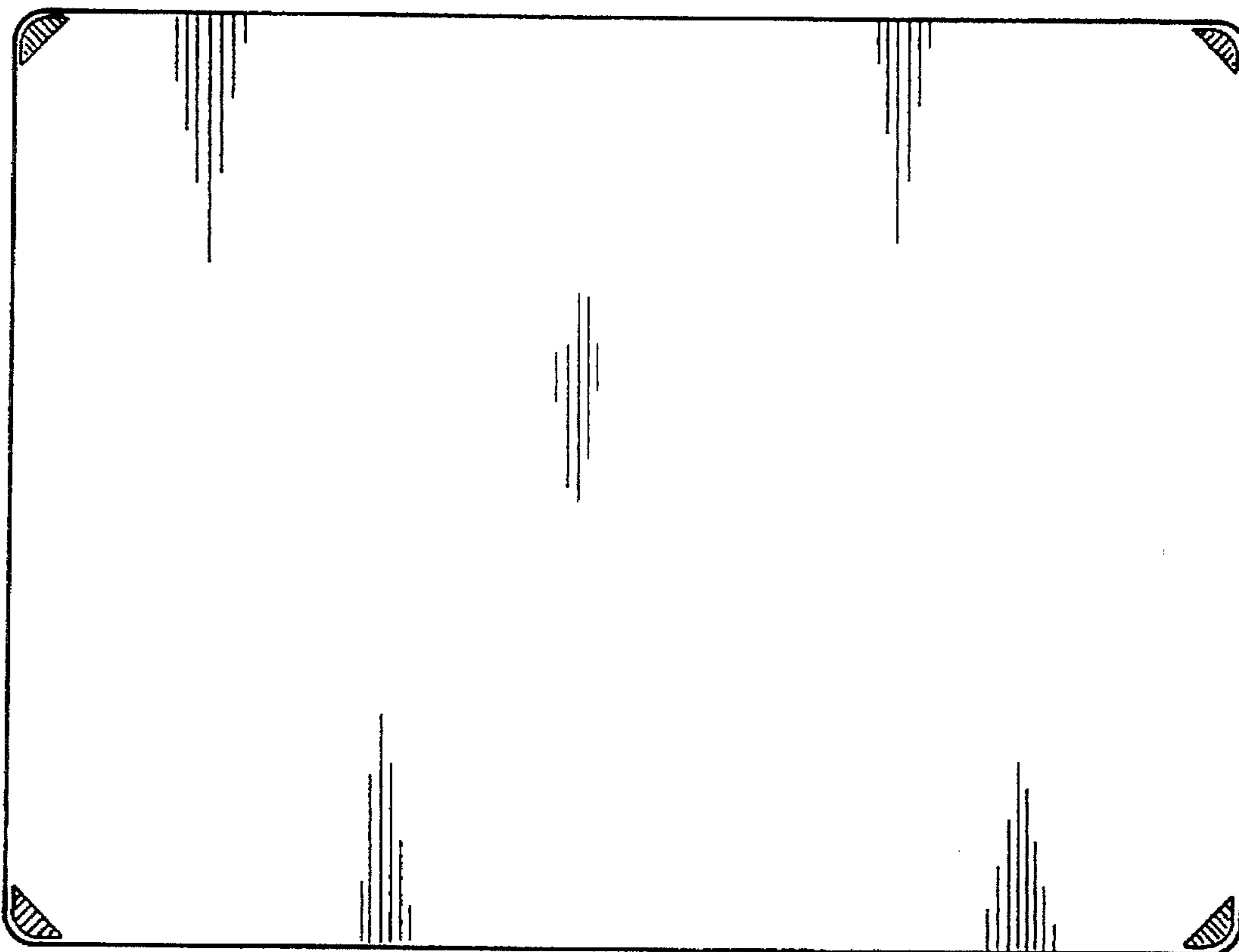

FIG. 6

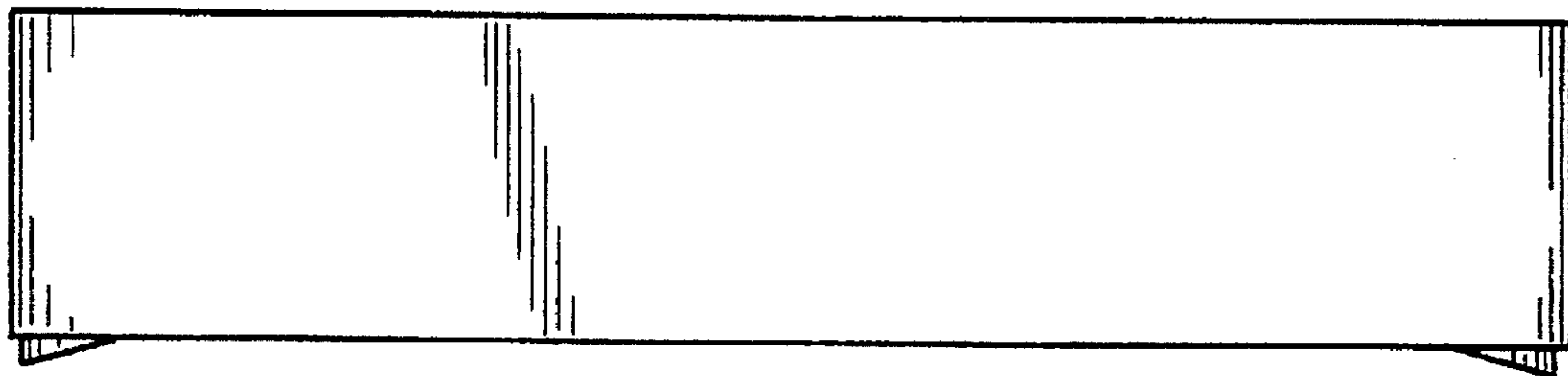

FIG. 7

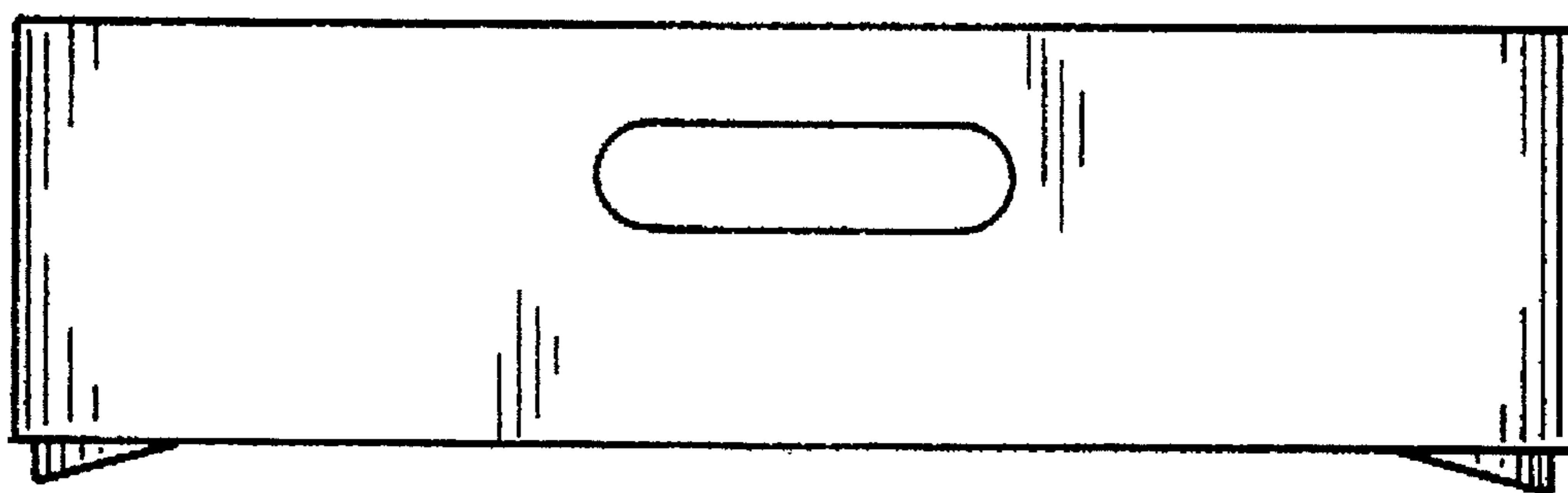

FIG. 8

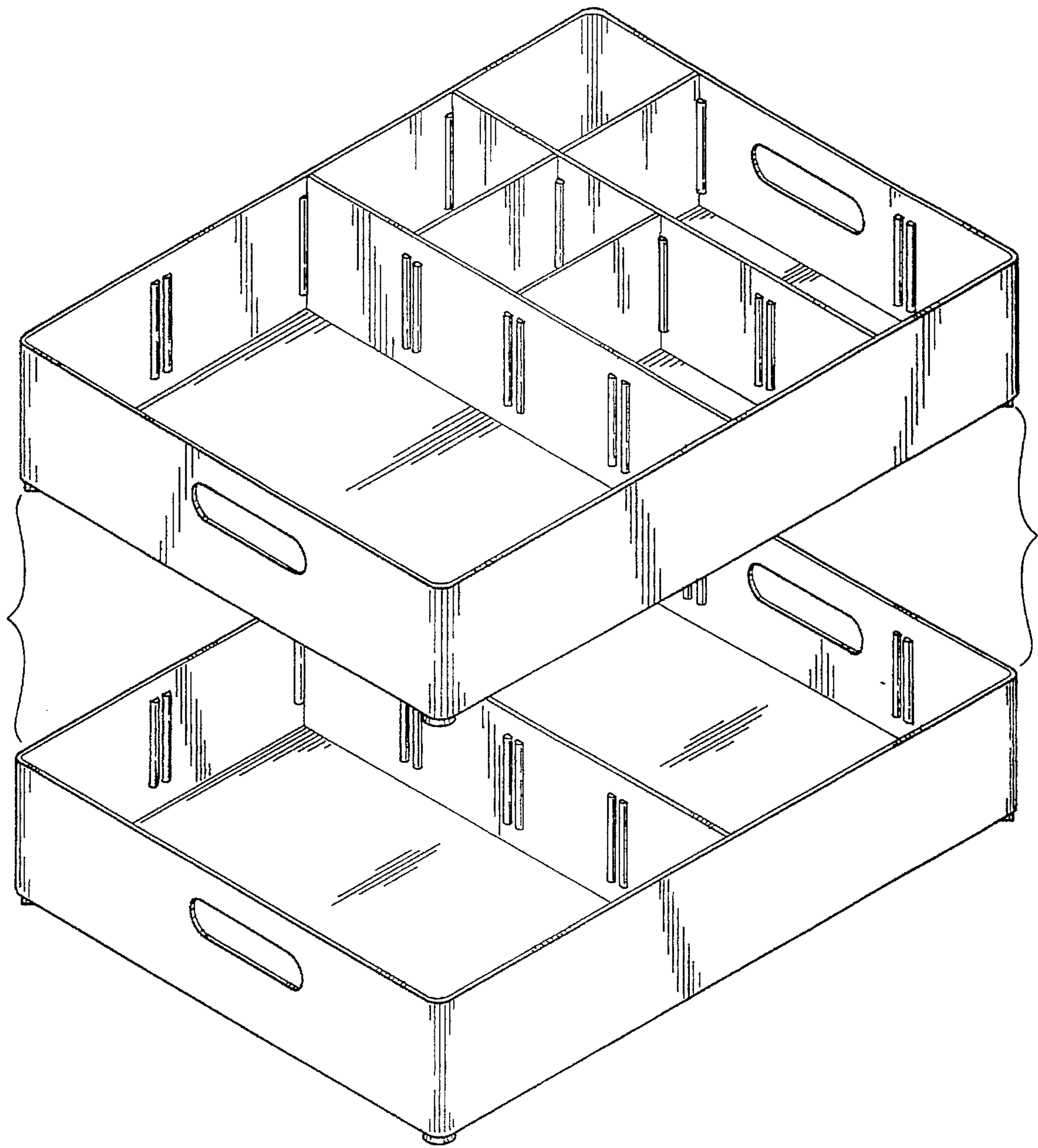

FIG. 9

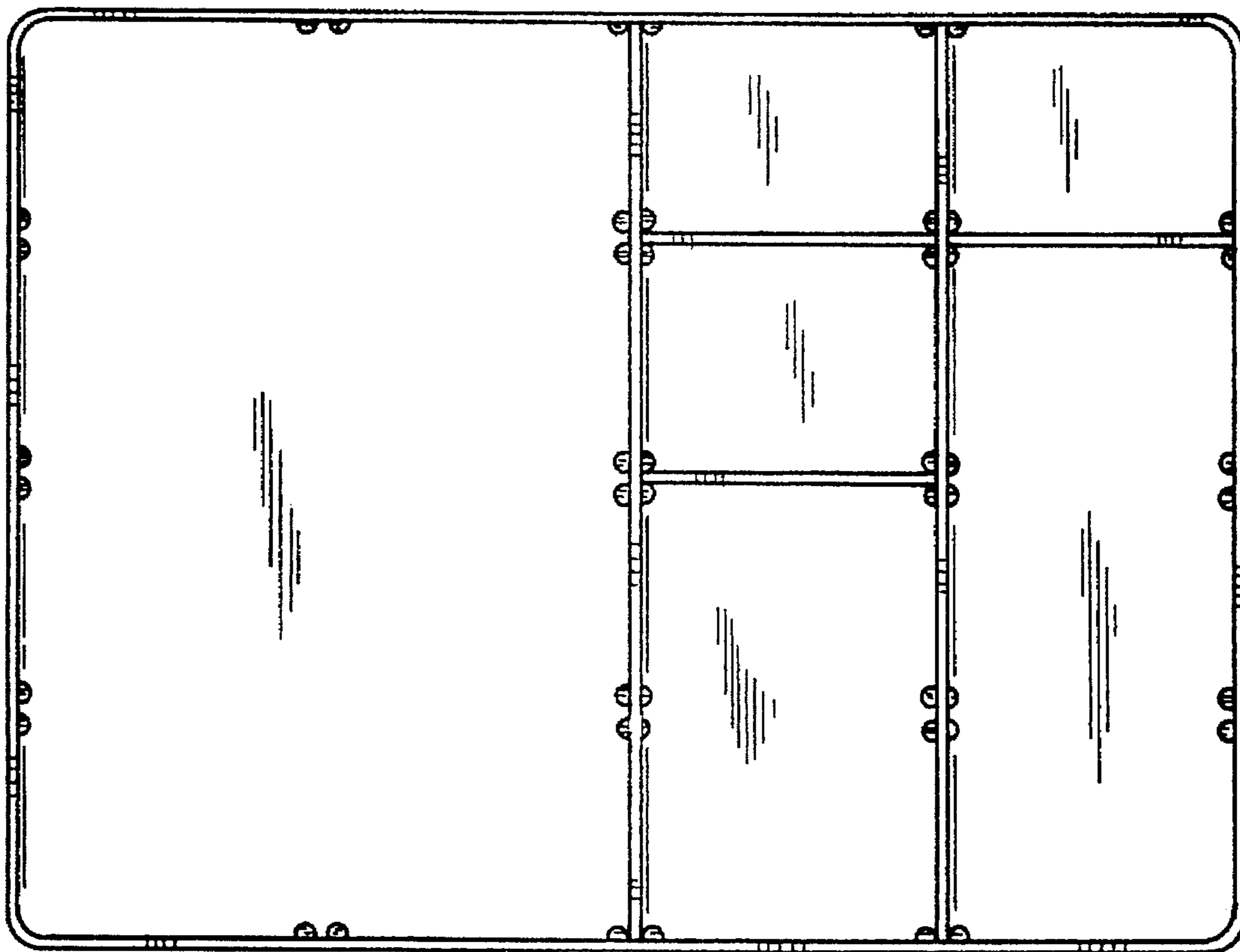

FIG. 10

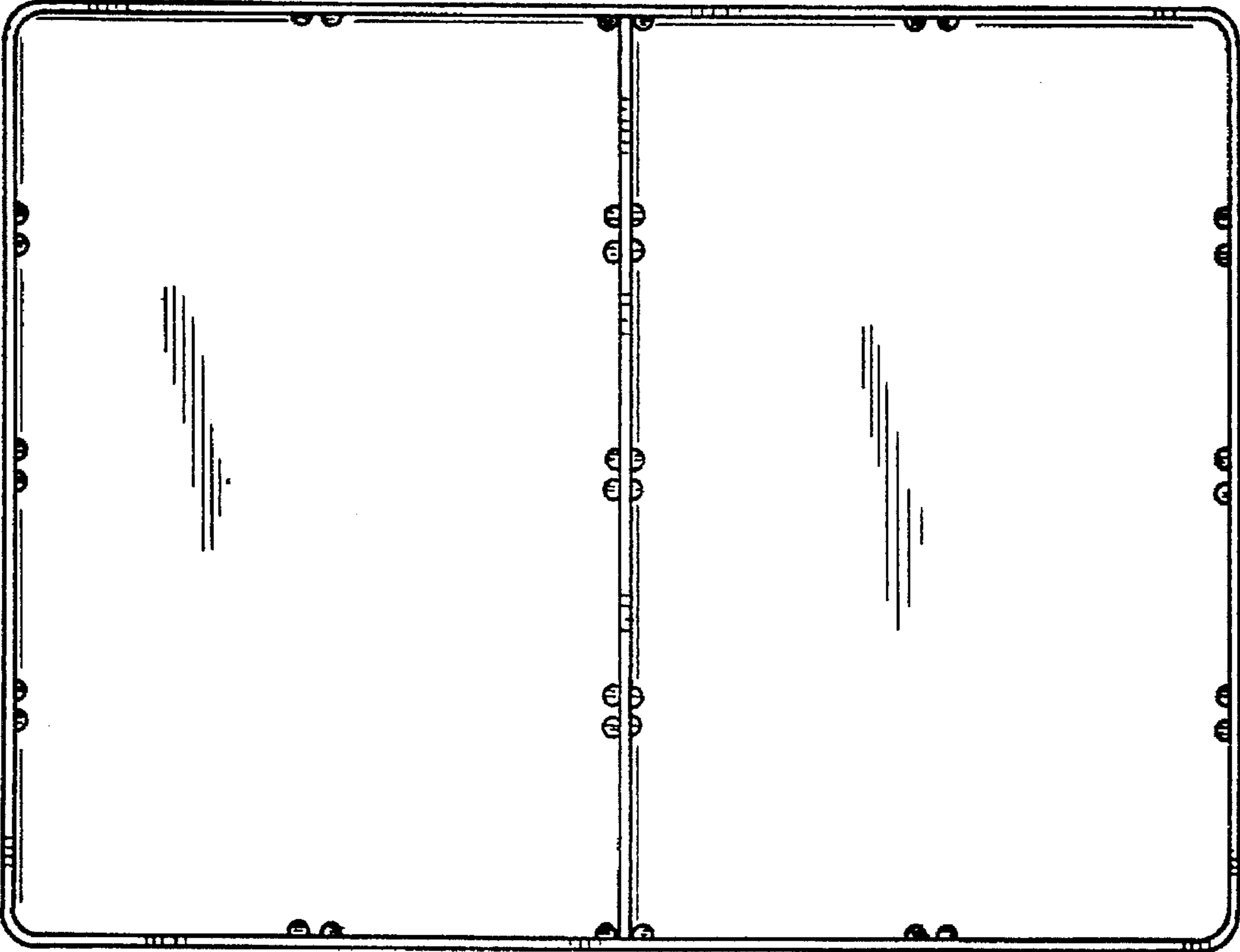

FIG. 11