



US00D380263S

United States Patent [19]
Christiansen

[11] **Patent Number: Des. 380,263**

[45] **Date of Patent: **Jun. 24, 1997**

[54] **HAIR REMOVER**

[76] **Inventor: Cindy A. Christiansen, 2627 W. Countryside La., West Jordan, Utah 84084**

[**] **Term: 14 Years**

[21] **Appl. No.: 46,086**

[22] **Filed: Nov. 7, 1995**

[51] **LOC (6) Cl. 24-02**

[52] **U.S. Cl. D24/133**

[58] **Field of Search D24/133; D28/10, D28/44, 45; 606/133, 134; 401/208, 1**

[56] **References Cited**

U.S. PATENT DOCUMENTS

- D. 322,334 12/1991 Brun D24/133 X
- D. 326,166 5/1992 Yanagida et al. D28/44

Primary Examiner—Louis S. Zarfes

Assistant Examiner—I. Simmons

Attorney, Agent, or Firm—James A. Hudak

[57] **CLAIM**

The ornamental design for a hair remover, as shown and described.

DESCRIPTION

FIG. 1 is a perspective view of the hair remover showing my new design;

FIG. 2 is a right side elevational view thereof;

FIG. 3 is a left side elevational view thereof;

FIG. 4 is a front elevational view thereof;

FIG. 5 is a rear elevational view thereof;

FIG. 6 is a top plan view thereof;

FIG. 7 is a bottom plan view thereof; and,

FIG. 8 is an exploded perspective view thereof.

1 Claim, 5 Drawing Sheets

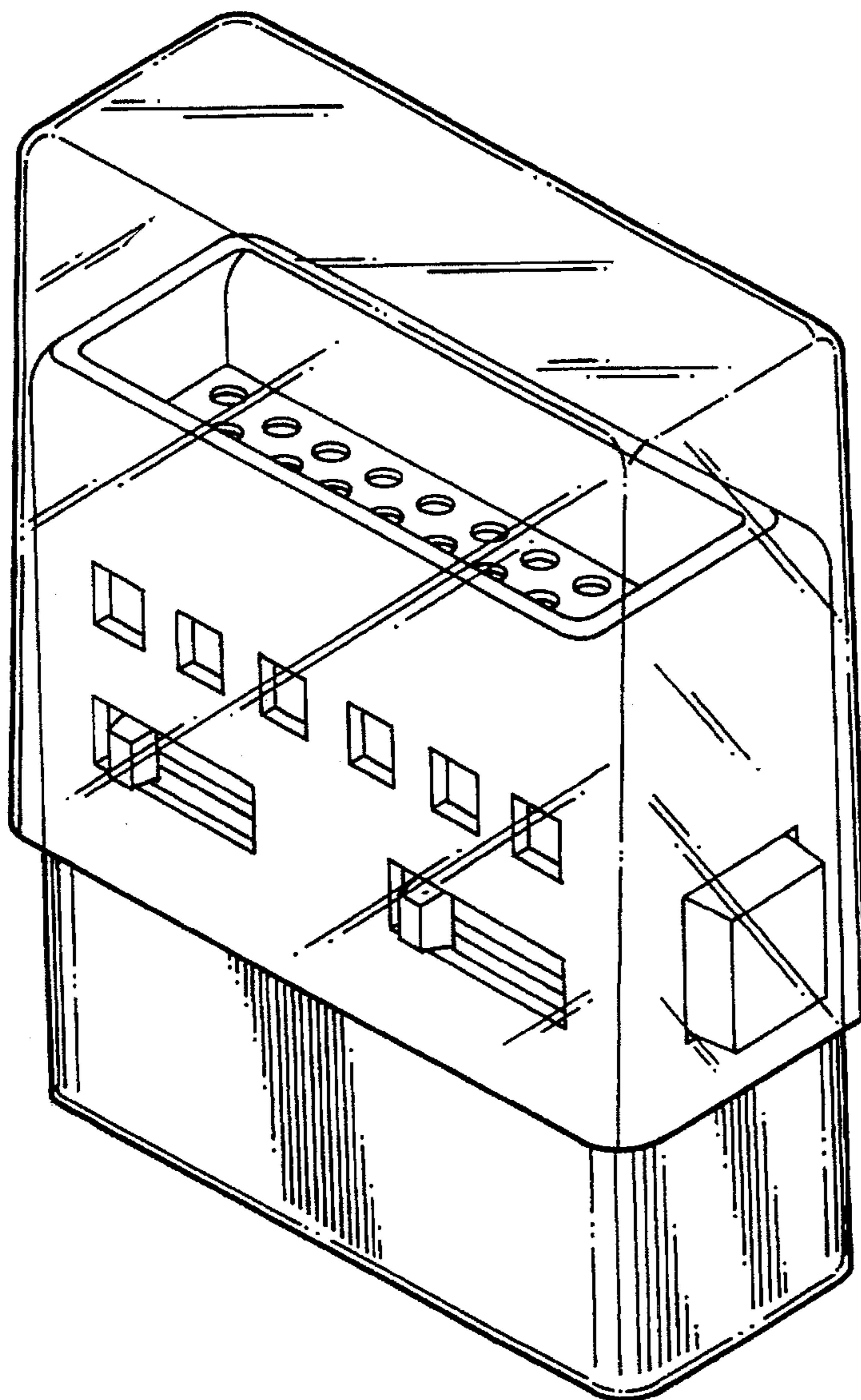

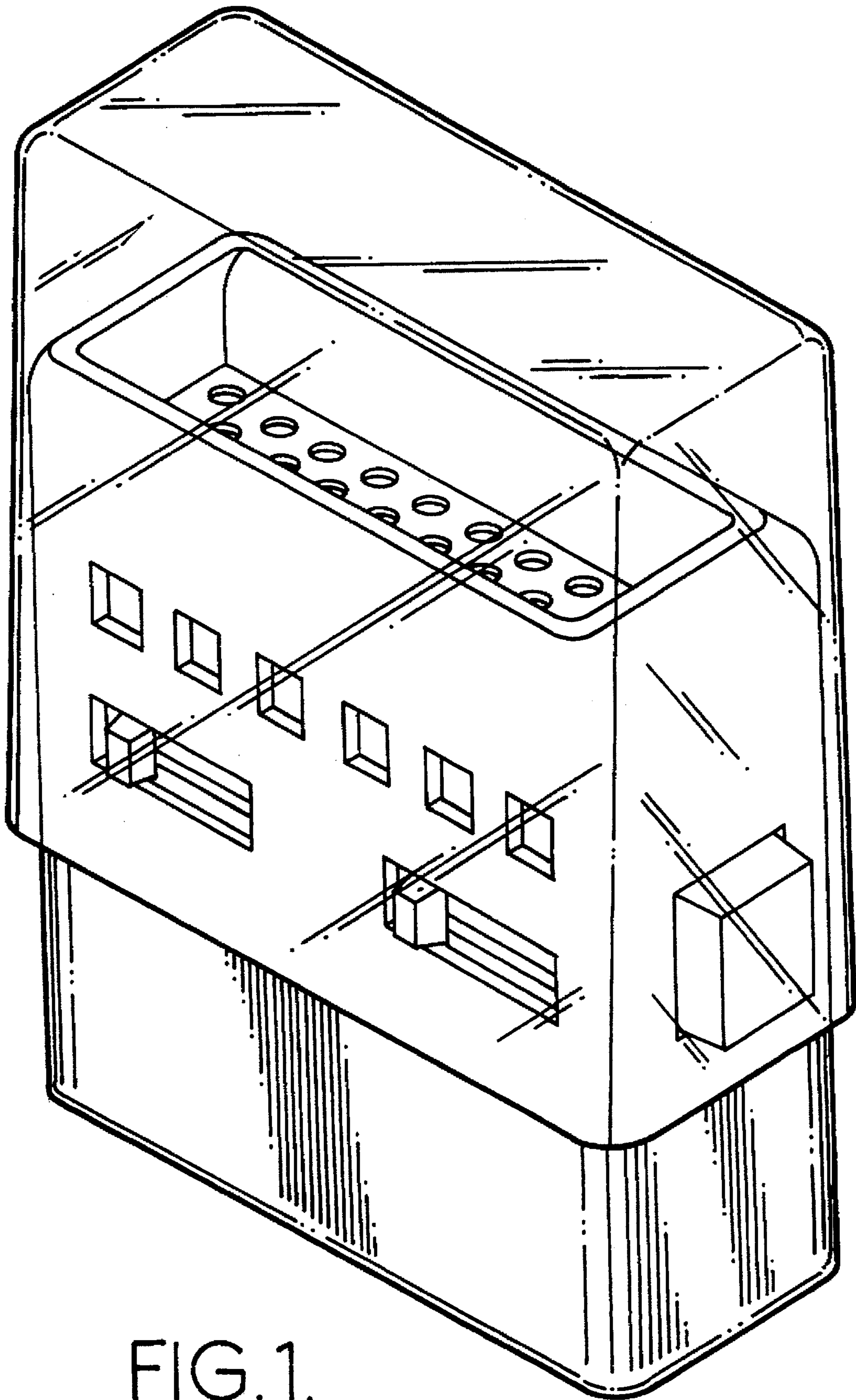

FIG. 1.

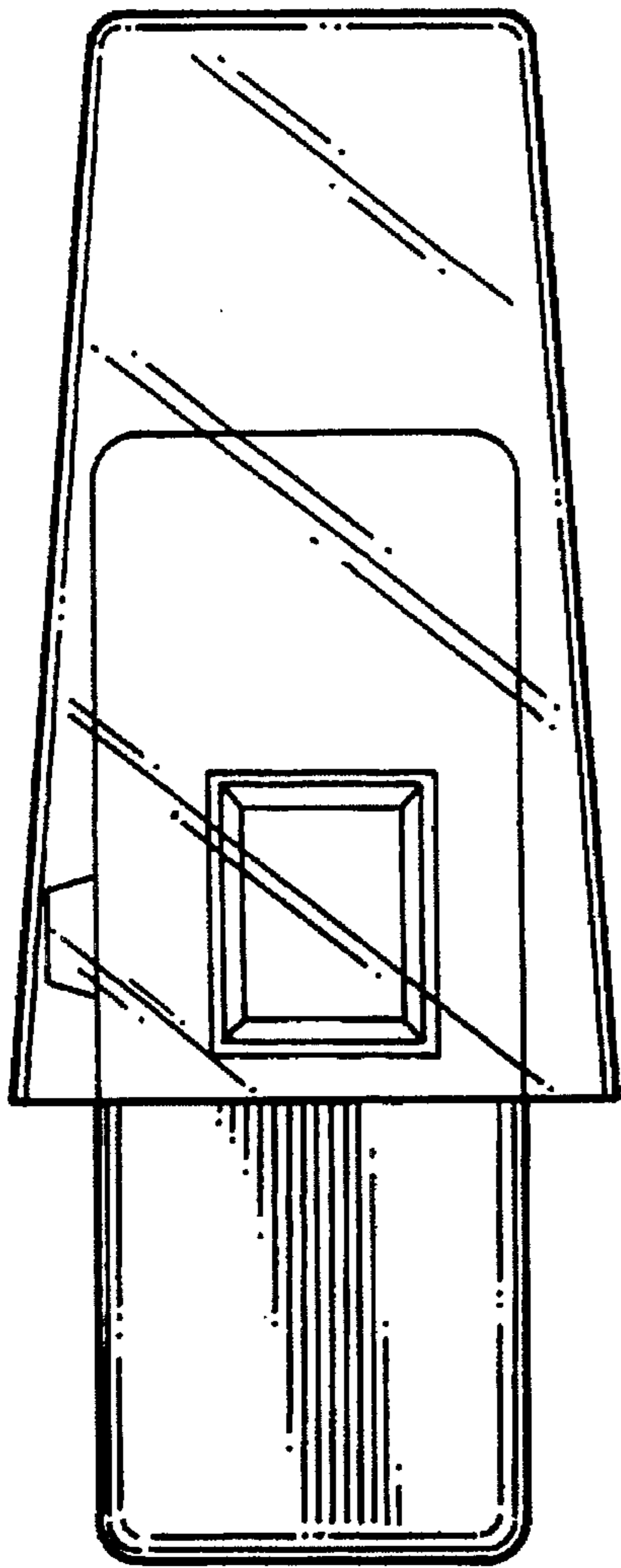

FIG. 2.

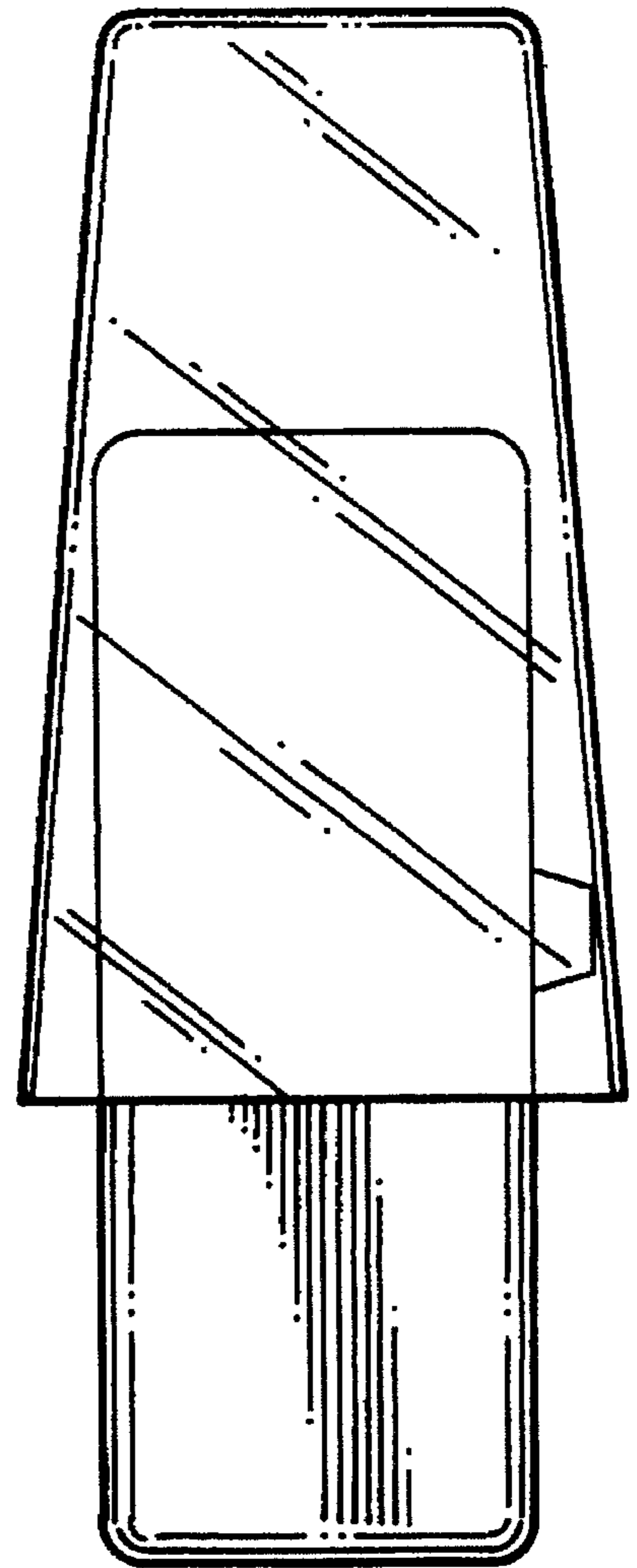

FIG. 3.

FIG. 4.

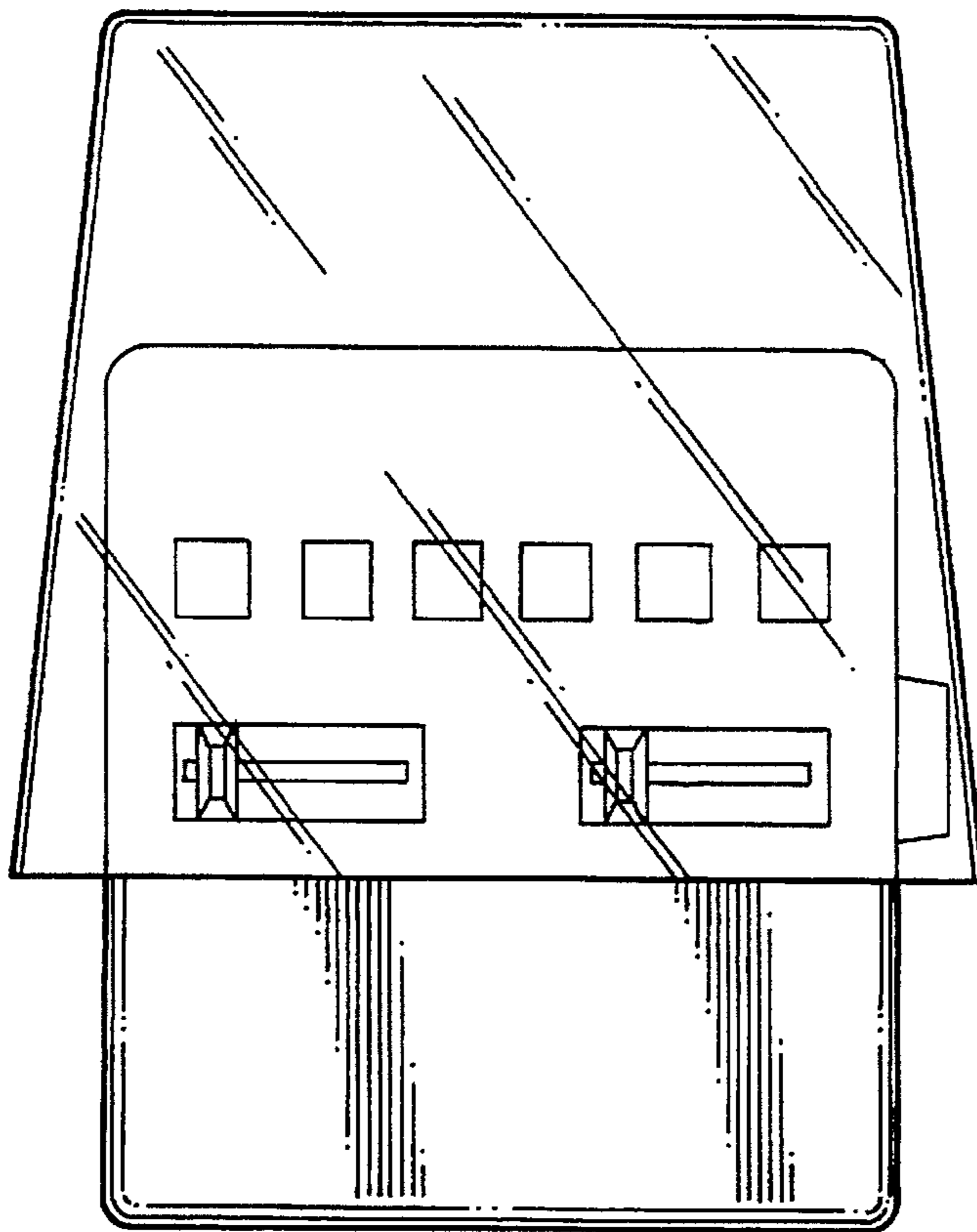
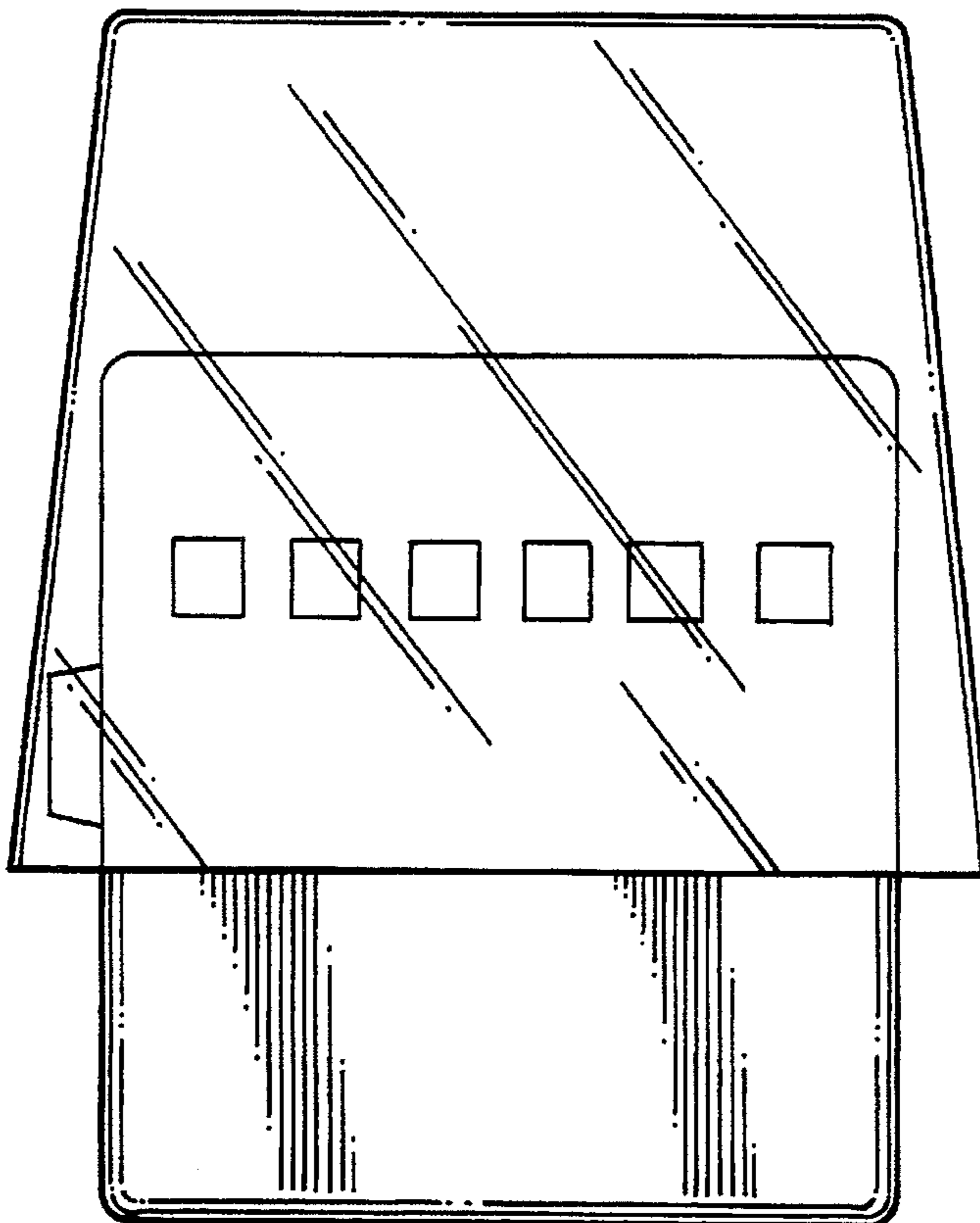

FIG. 5.



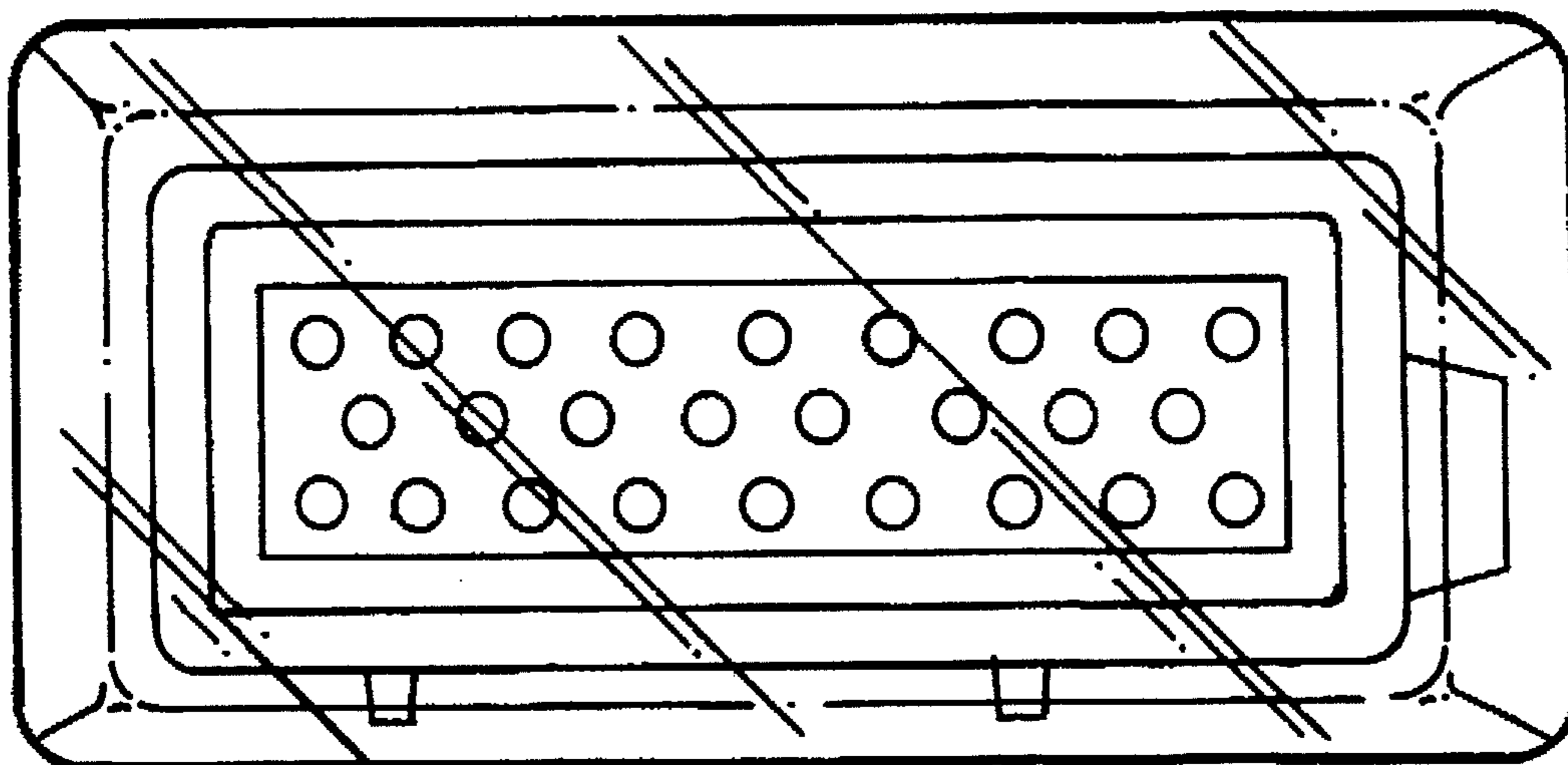

FIG. 6.

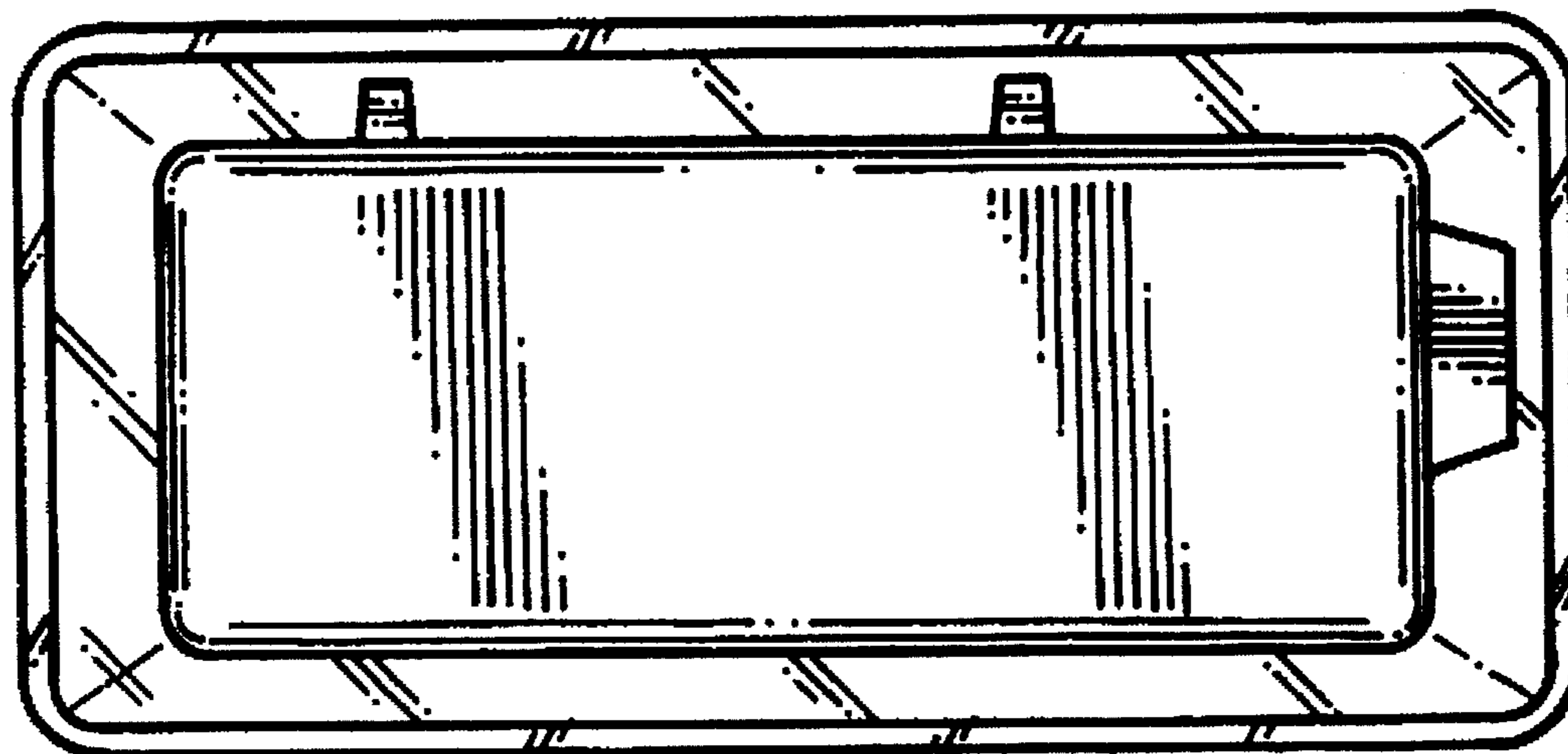

FIG. 7.

FIG. 8.

