



US00D380231S

United States Patent [19]

[11] Patent Number: Des. 380,231

Chow

[45] Date of Patent: **Jun. 24, 1997

[54] **ELECTRONIC EDUCATIONAL GAME HOUSING**

Assistant Examiner—Pamela Burgess
Attorney, Agent, or Firm—Dick and Harris

[75] Inventor: **Ka Wah Chow**, New Territories, Hong Kong

[57] **CLAIM**

The ornamental design for an electronic educational game housing, as shown and described.

[73] Assignee: **VTech Industries, Inc.**, Wheeling, Ill.

[**] Term: **14 Years**

DESCRIPTION

[21] Appl. No.: **33,341**

FIG. 1 is a left rear perspective view of the electronic educational game housing, with the lid portion lowered, showing my new design;

[22] Filed: **Jan. 10, 1995**

FIG. 2 is a left rear perspective view thereof with the lid portion raised;

[51] LOC (6) Cl. **19-07**

[52] U.S. Cl. **D19/60; D14/100; D21/13**

FIG. 3 is a top plan view thereof with the lid portion lowered;

[58] Field of Search **D19/59, 60, 62, D19/64; 434/201, 202, 323, 327, 339, 335, 308; D21/13; D14/106**

FIG. 4 is a right rear perspective view thereof with the lid portion raised;

[56] **References Cited**

U.S. PATENT DOCUMENTS

- D. 321,176 10/1991 Ma D14/106
- D. 342,501 12/1993 Saeki et al. D14/106 X
- D. 343,831 2/1994 Spoeth D14/106
- 4,731,027 3/1988 Phinny 434/169 X

FIG. 5 is a left front perspective view thereof with the lid portion raised;

FIG. 6 is a bottom plan view thereof; and,

FIG. 7 is a fragmentary sectional view of the surface of the convex feature on the lid of the embodiment of FIGS. 1-6, taken along a line perpendicular to the three parallel features on the front portion of the convex feature.

Primary Examiner—Brian N. Vinson

1 Claim, 4 Drawing Sheets

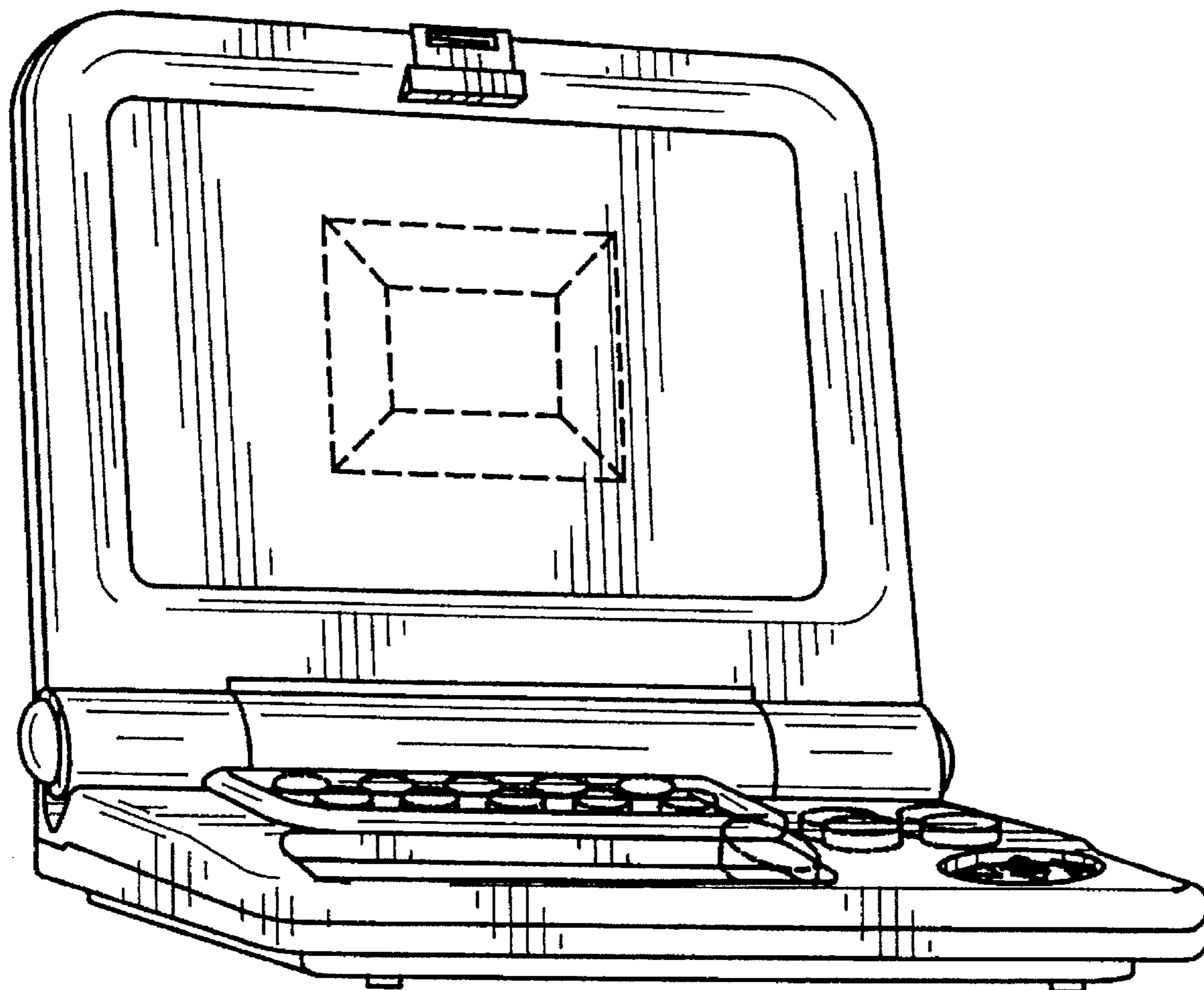

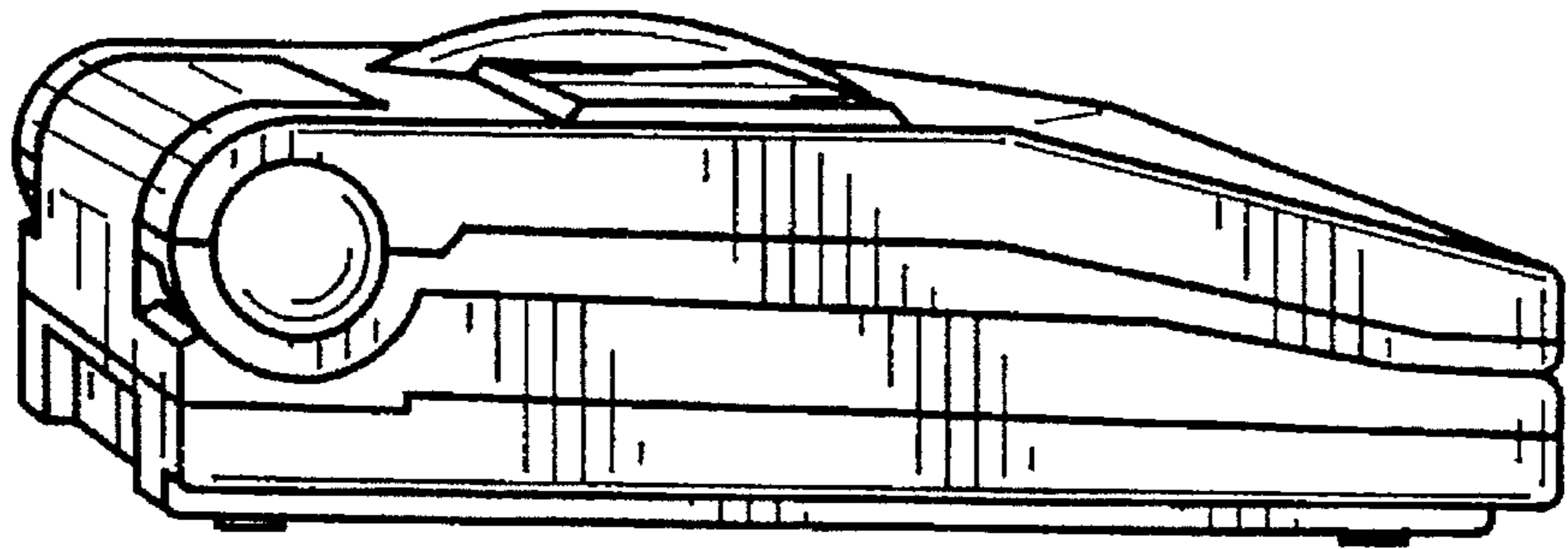

FIG. 1

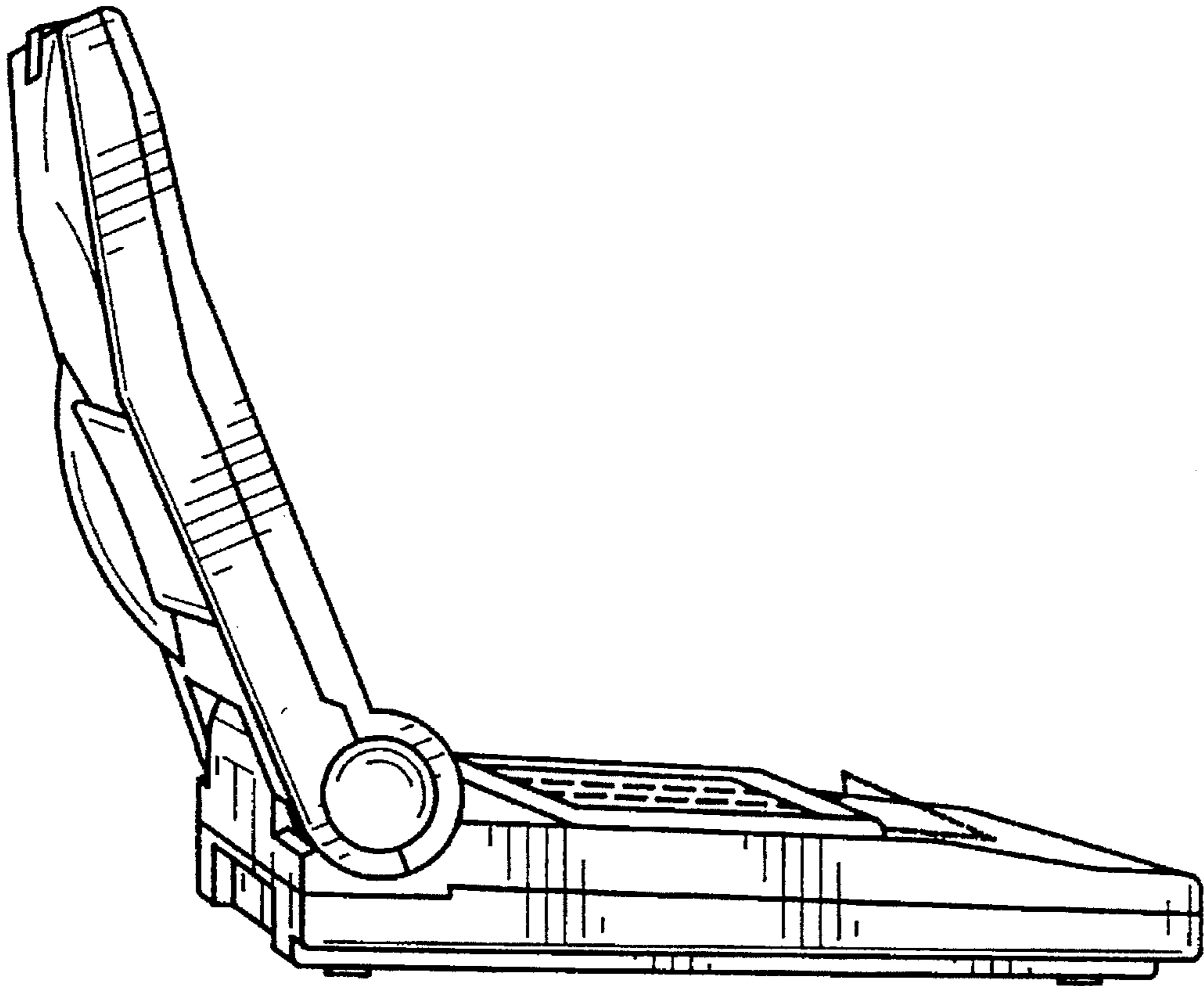

FIG. 2

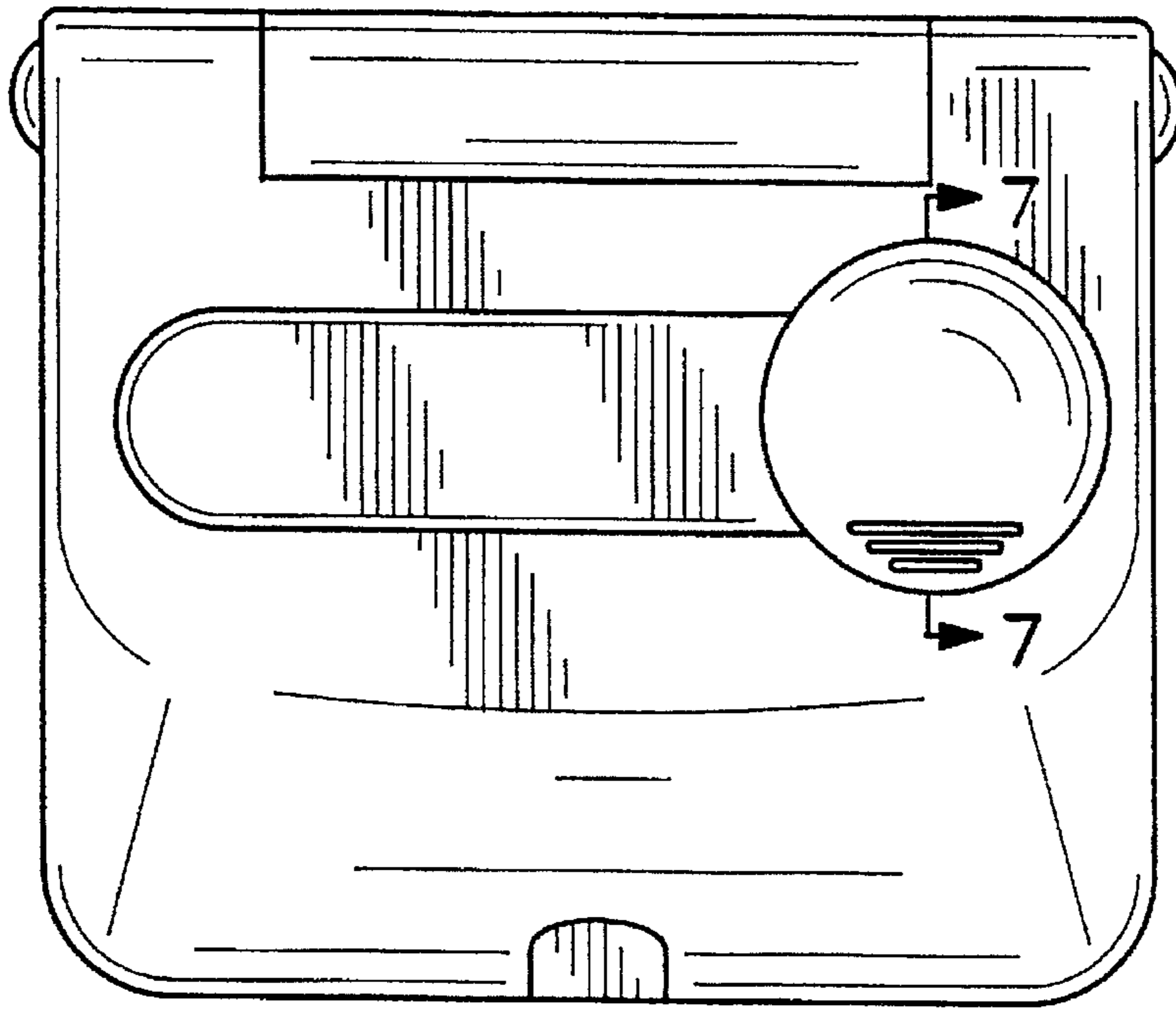

FIG. 3

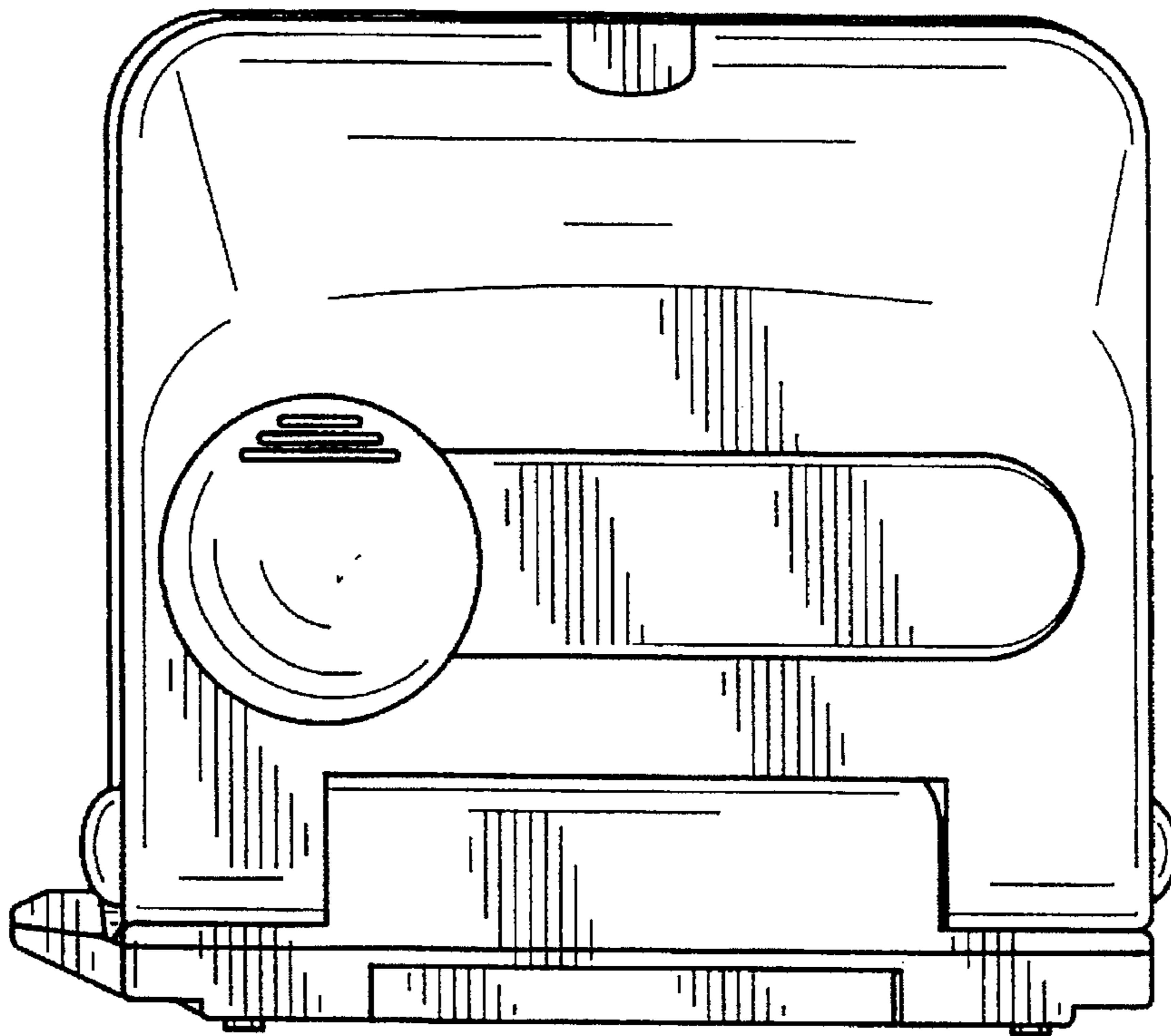

FIG. 4

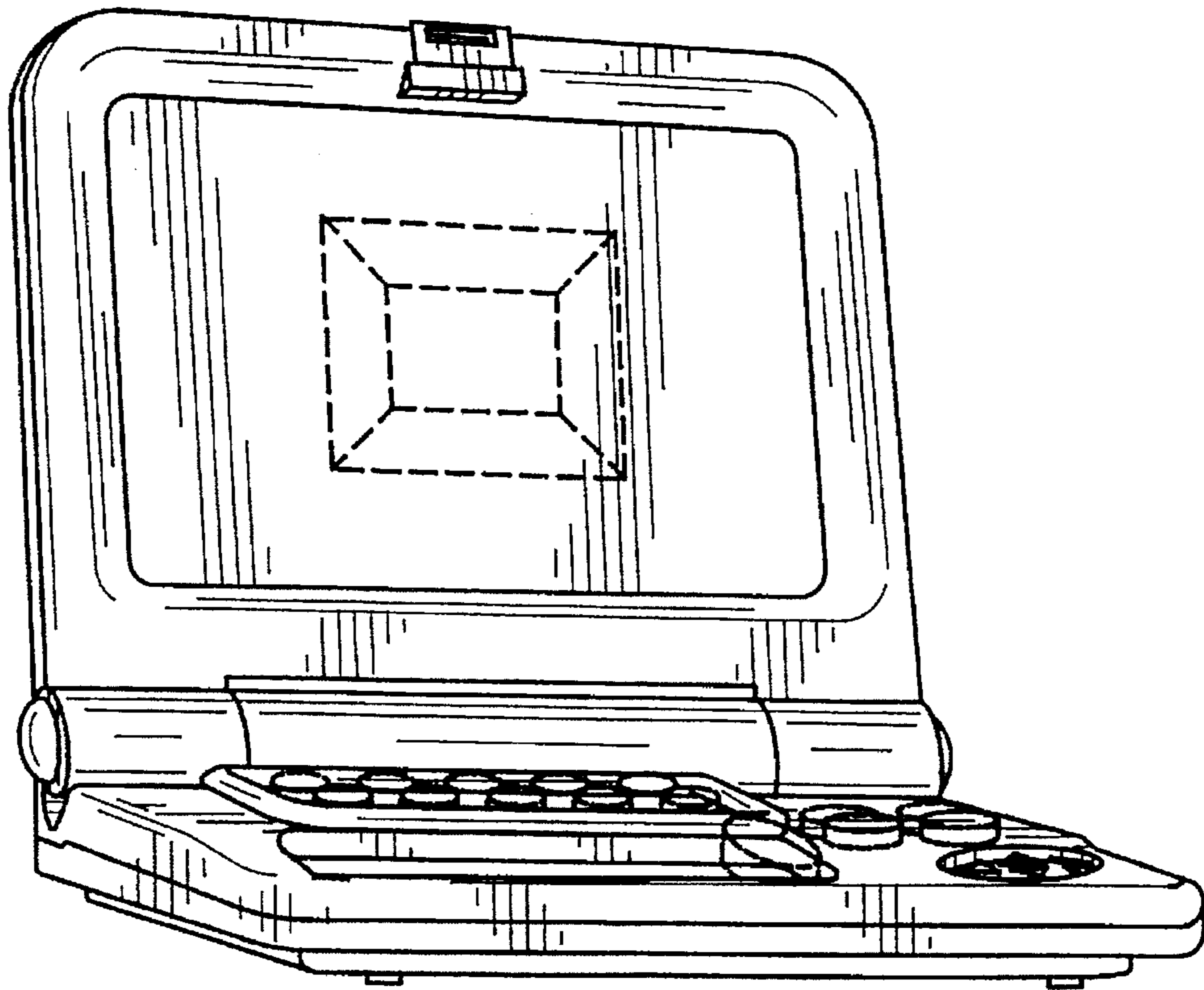

FIG. 5

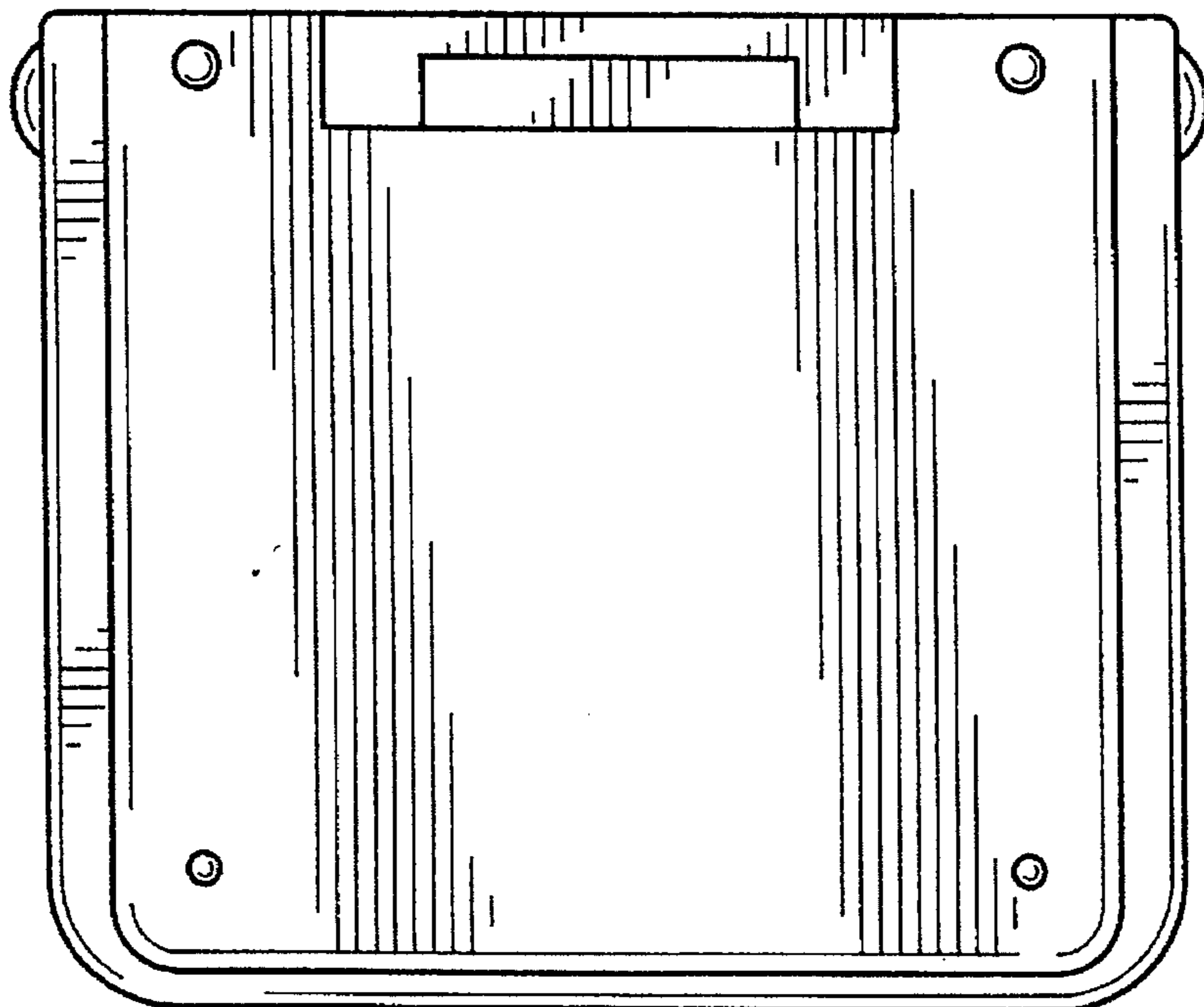

FIG. 6

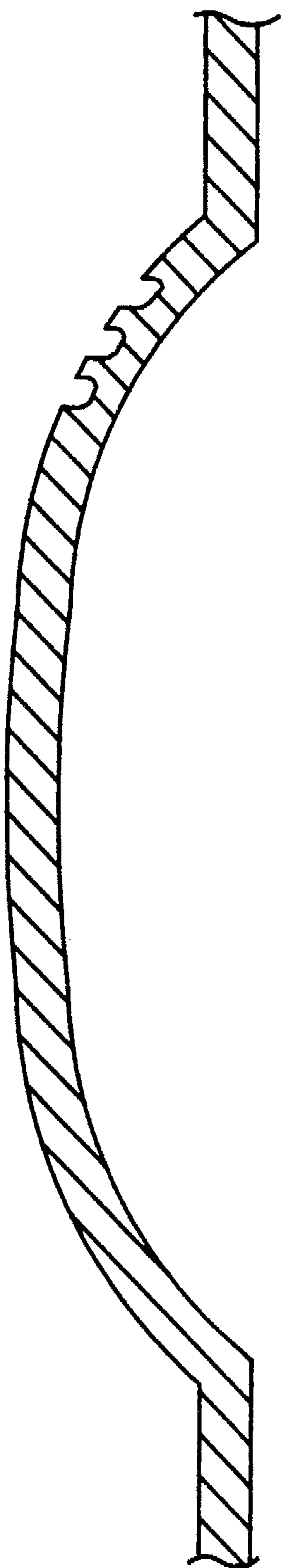

FIG. 7