



US00D380206S

United States Patent [19]

Hill et al.

[11] Patent Number: **Des. 380,206**

[45] Date of Patent: ****Jun. 24, 1997**

[54] **MEDIA DRIVE FOR A DATA PROCESSING SYSTEM**

D. 356,784 3/1995 Hill et al. D14/109 X

[75] Inventors: **David Wayne Hill; Tim Kerry Murphy**, both of Rochester, Minn.

Primary Examiner—Freda Nunn
Attorney, Agent, or Firm—Matthew J. Bussan

[73] Assignee: **International Business Machines Corporation**, Armonk, N.Y.

[57] **CLAIM**

[**] Term: **14 Years**

The ornamental design for a media drive for a data processing system, as shown and described.

[21] Appl. No.: **38,244**

DESCRIPTION

[22] Filed: **May 1, 1995**

FIG. 1 is a top, front, right side isometric view of a media drive for a data processing system, showing our new design;

[51] LOC (6) Cl. **14-02**

[52] U.S. Cl. **D14/109**

FIG. 2 is a front elevational view thereof;

[58] Field of Search D14/100, 102,

FIG. 3 is a top plan view thereof;

D14/107-109; D13/162, 184, 199; D6/432, 436, 445, 448; 312/208.1, 223.2, 223.3; 360/97.01, 97.04, 98.01; 361/694, 696

FIG. 4 is a bottom plan view thereof;

FIG. 5 is a right side elevational view thereof, the left side being identical; and,

[56] **References Cited**

FIG. 6 is a rear elevational view thereof.

U.S. PATENT DOCUMENTS

D. 325,194 4/1992 Kline et al. D14/100

1 Claim, 6 Drawing Sheets

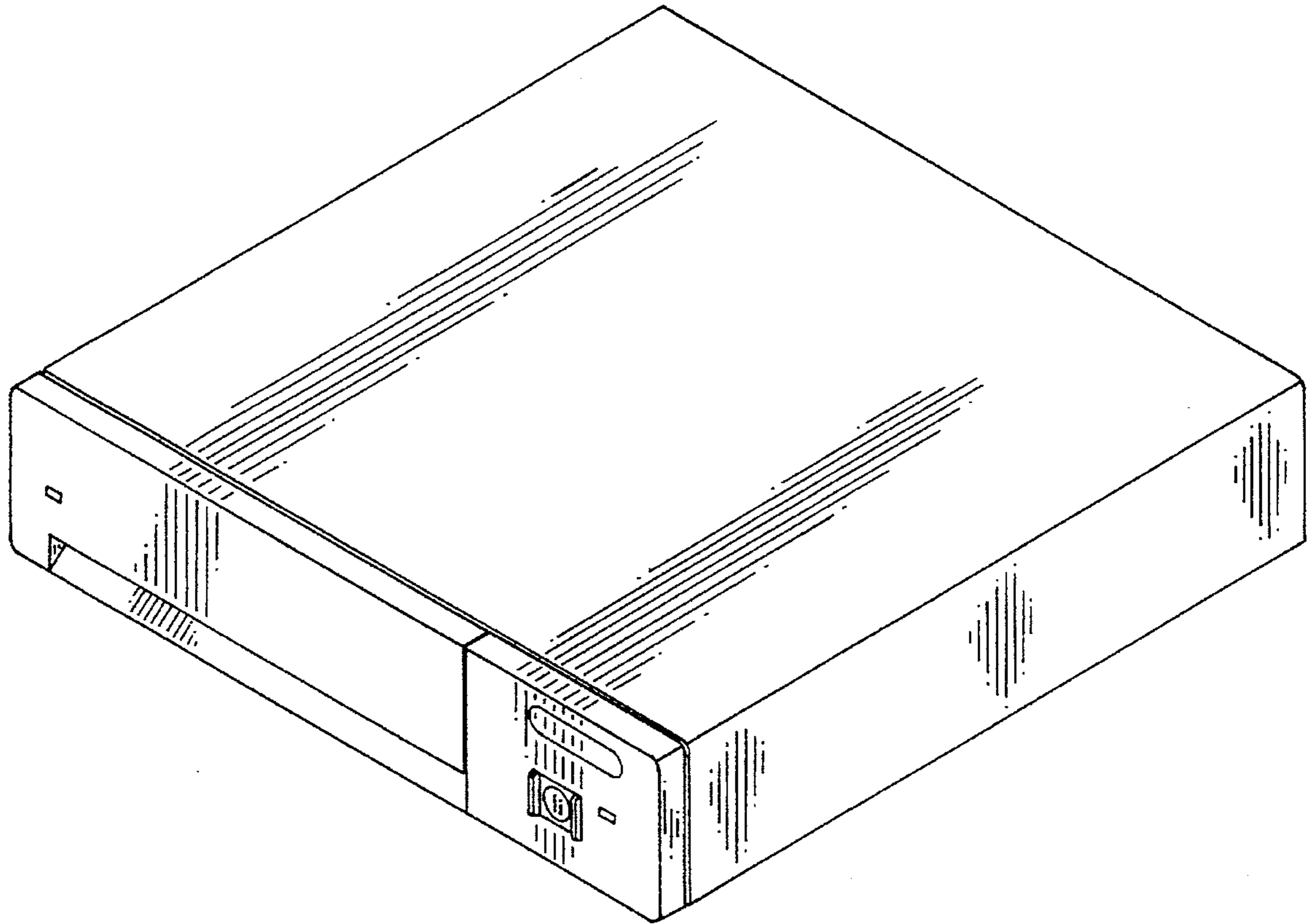

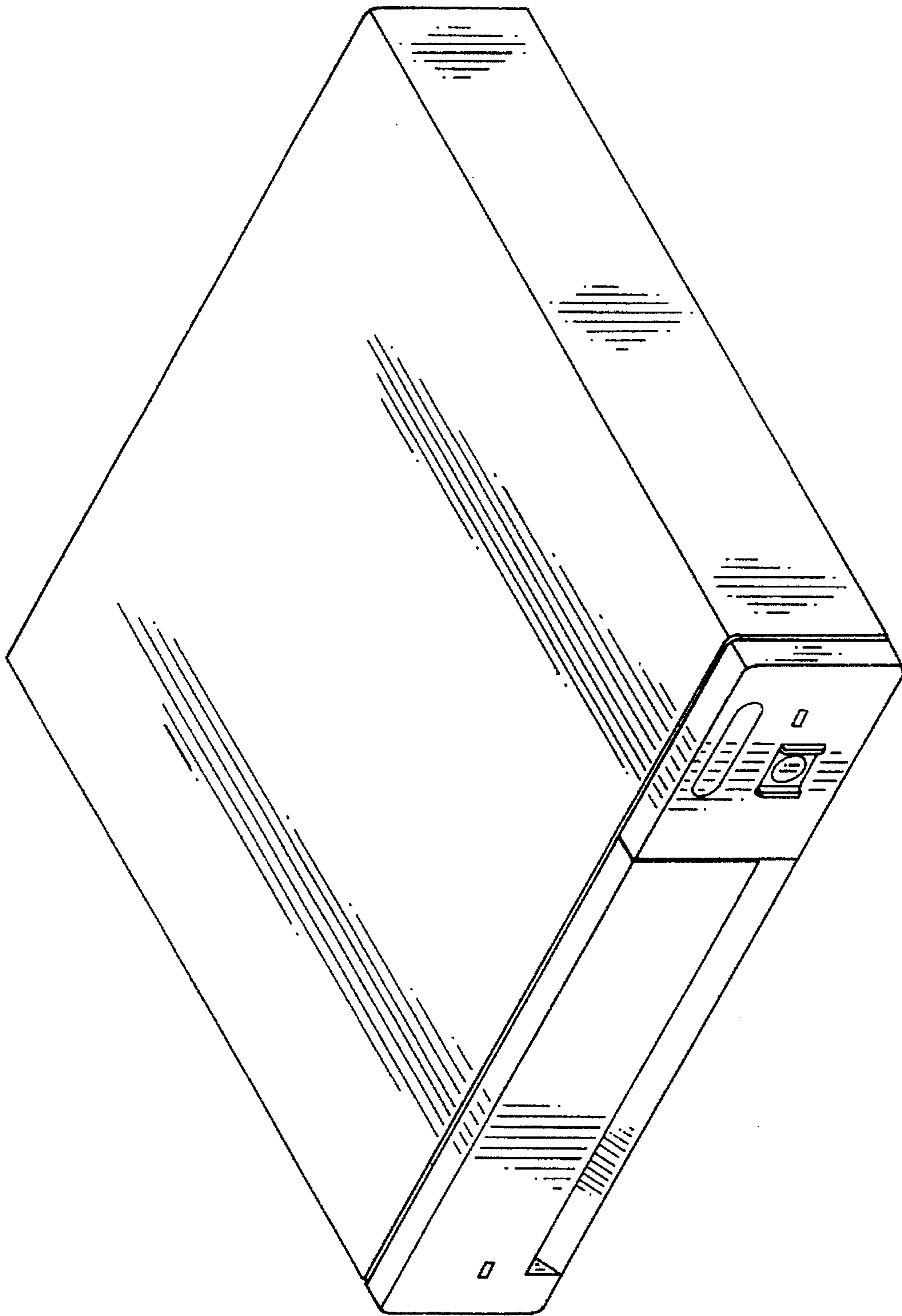

FIG. 1

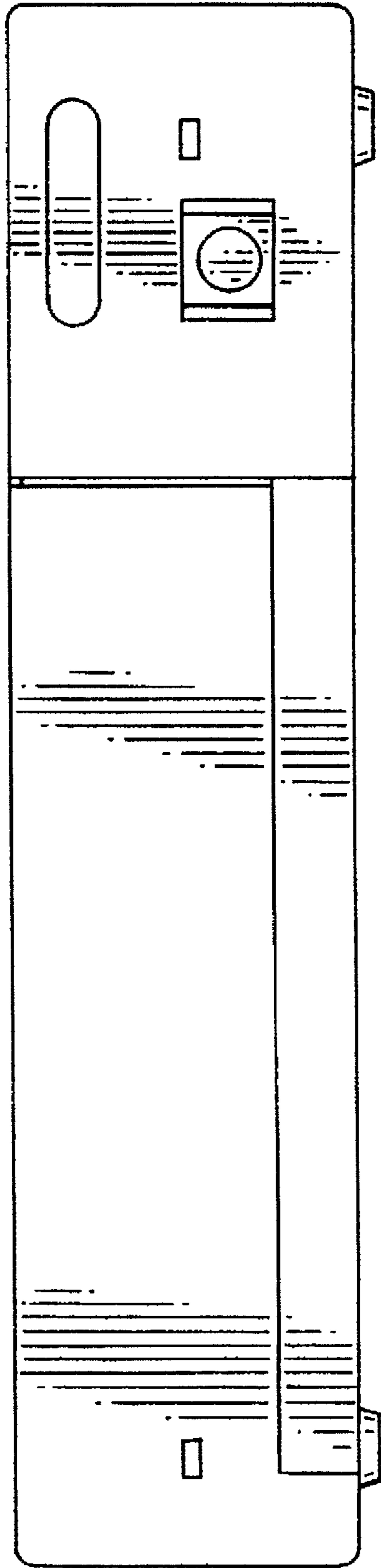

FIG. 2

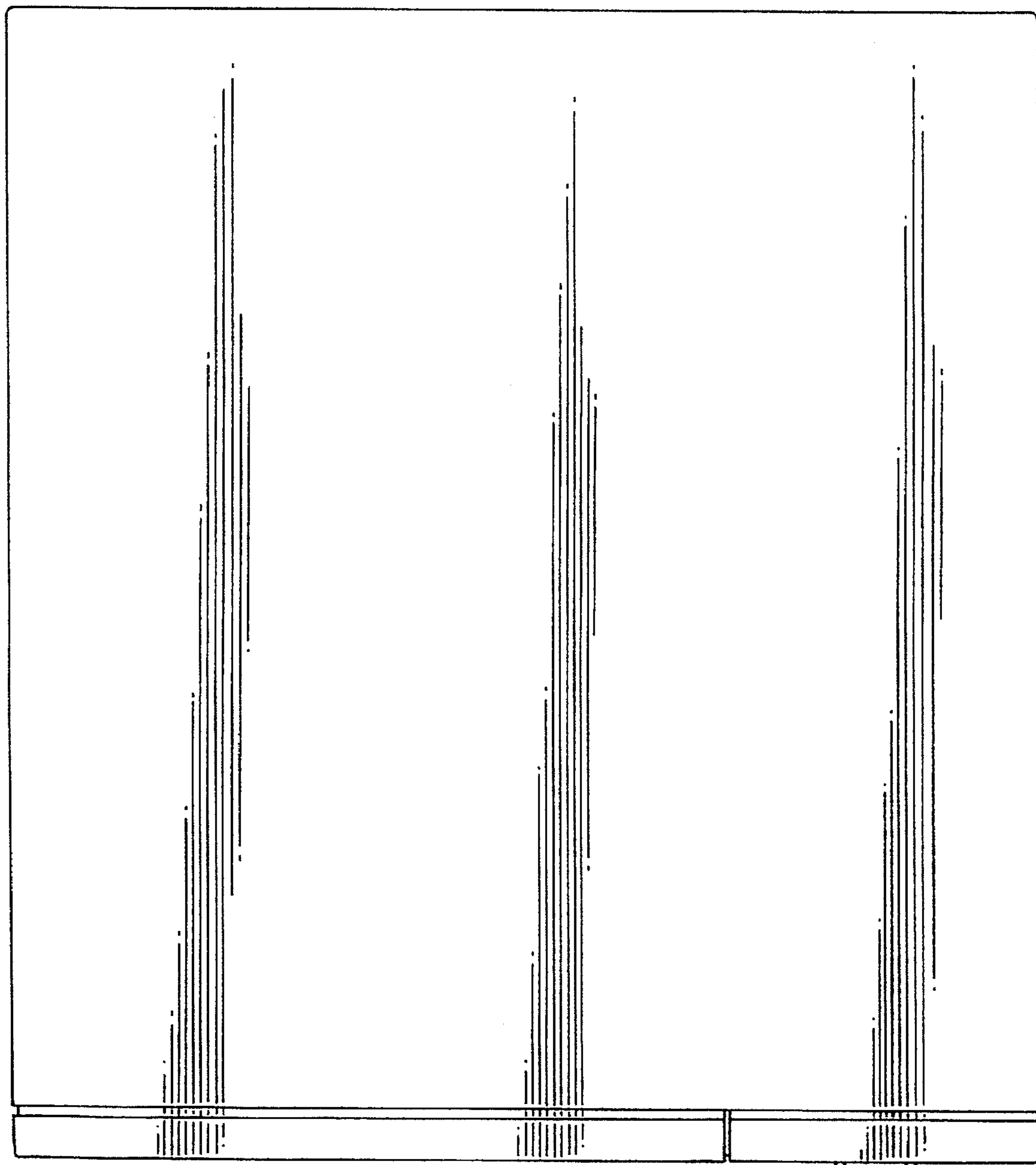

FIG. 3

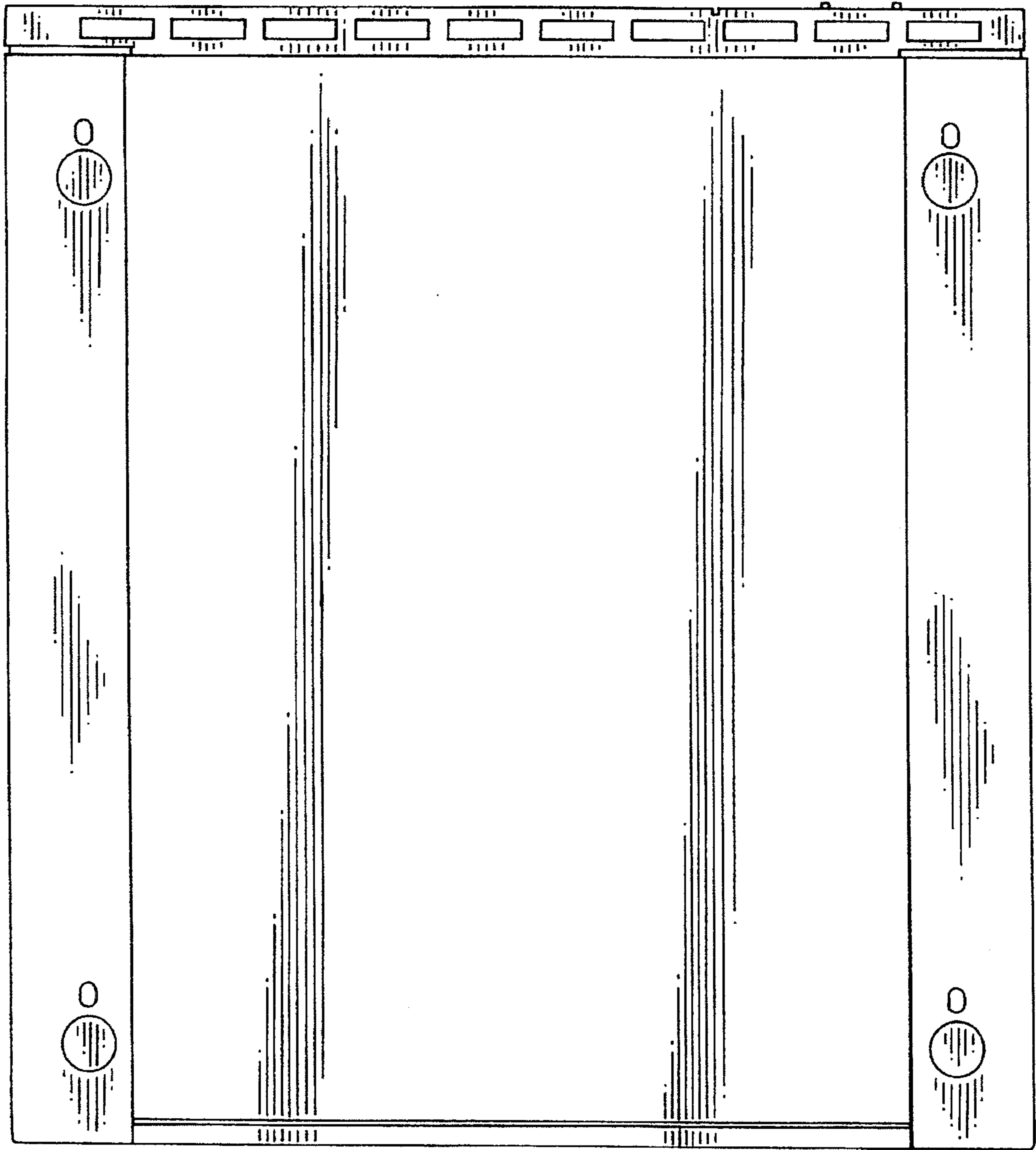

FIG. 4

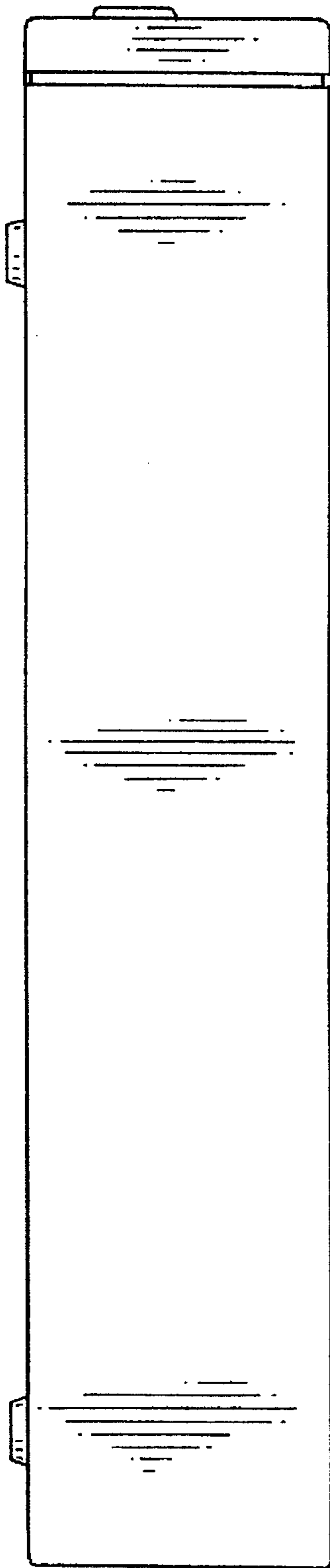

FIG. 5

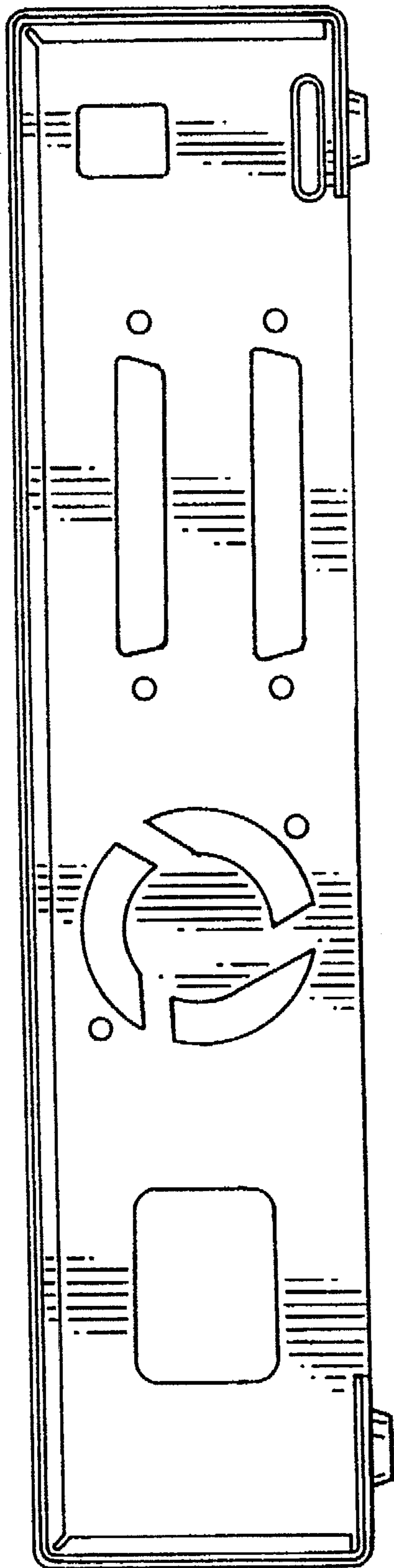

FIG. 6