



US00D380176S

United States Patent [19]

Weder et al.

[11] Patent Number: Des. 380,176

[45] Date of Patent: **Jun. 24, 1997

[54] FLOWER POT COVER

2,355,559 8/1944 Renner 229/8
5,127,817 7/1992 Weder et al. 425/383

[75] Inventors: Donald E. Weder; Joseph G. Straeter,
both of Highland, Ill.

OTHER PUBLICATIONS

[73] Assignee: Southpac Trust International, Inc.,
Oklahoma City, Okla.

Exhibit A—"The Simple Solution For Those Peak Volume
Periods", a brochure published by Highland Supply Corpo-
ration, 1111 Sixth St., Highland, Illinois 62249, ©1989.

[**] Term: 14 Years

Primary Examiner—Jeffrey Asch
Attorney, Agent, or Firm—Dunlap & Coddling, P.C.

[21] Appl. No.: 50,903

[57] CLAIM

[22] Filed: Feb. 29, 1996

The ornamental design for a flower pot cover, as shown and
described.

Related U.S. Application Data

DESCRIPTION

[60] Division of Ser. No. 8,192, May 10, 1993, Pat. No. Des.
371,324, which is a continuation-in-part of Ser. No. 807,897,
Dec. 16, 1991, Pat. No. Des. 364,582, which is a continu-
ation-in-part of Ser. No. 710,272, Jun. 4, 1991, Pat. No. Des.
365,382, which is a continuation-in-part of Ser. No. 617,454,
Nov. 21, 1990, abandoned, and a continuation-in-part of Ser.
No. 411,249, Sep. 22, 1989, Pat. No. Des. 358,113, and a
continuation-in-part of Ser. No. 411,247, Sep. 22, 1989,
abandoned, and a continuation-in-part of Ser. No. 411,245,
Sep. 22, 1989, abandoned.

FIG. 1 is a perspective view of our new flower pot cover
design;

FIG. 2 is a side elevational view thereof;

FIG. 3 is a top plan view thereof;

FIG. 4 is a bottom plan view thereof;

FIG. 5 is a side elevational view of the design of FIG. 1, the
only difference being in the horizontal angle of the skirt;

FIG. 6 is a side elevational view of the design of FIG. 1, the
only difference being in the near vertical angle of the skirt;

FIG. 7 is a side elevational view of the design of FIG. 1, the
only difference being in the downward angle of the skirt;

FIG. 8 is a fragmentary enlarged top plan view of a second
embodiment of the design of FIG. 1, the only difference
being in the skirt edge;

FIG. 9 is a fragmentary enlarged top plan view of a third
embodiment of the design of FIG. 1, the only difference
being in the skirt edge;

FIG. 10 is a fragmentary enlarged top plan view of a fourth
embodiment of the design of FIG. 1, the only difference
being in the skirt edge;

FIG. 11 is a perspective view of a fifth embodiment of our
new flower pot cover design;

FIG. 12 is a side elevational view thereof;

FIG. 13 is a top plan view thereof;

FIG. 14 is a bottom plan view thereof;

FIG. 15 is a side elevational view of the design of FIG. 11,
the only difference being in the horizontal angle of the skirt;

FIG. 16 is a side elevational view of the design of FIG. 11,
the only difference being in the near vertical angle of the
skirt;

[51] LOC (6) Cl. 11-02

[52] U.S. Cl. D11/164

[58] Field of Search D11/143, 149,
D11/152-156, 164, 89, 90; 47/66, 72; 206/423;
215/100.5; 229/1.5 R, 1.5 B, 4.5, 108, 108.1,
109, 110, 87.01, 922, 930, 186, 189; 428/27,
35.1, 24, 542.6; 338/122; D9/346, 428-431;
D27/102, 133; D26/128-136; D19/96; D7/540,
584, 586, 587, 354

[56] References Cited

U.S. PATENT DOCUMENTS

D. 292,562	11/1987	Weder et al.	D11/164
D. 293,224	12/1987	Weder et al.	D11/164
D. 293,775	1/1988	Weder et al.	D11/164
D. 315,534	3/1991	Weder et al.	D11/164
D. 317,583	6/1991	Weder et al.	D11/164
D. 318,030	7/1991	Weder et al.	D11/164
D. 327,234	6/1992	Vaughn	D11/143
D. 364,119	11/1995	Weder et al.	D11/164
D. 364,582	11/1995	Weder et al.	D11/164
D. 371,324	7/1996	Weder et al.	D11/164

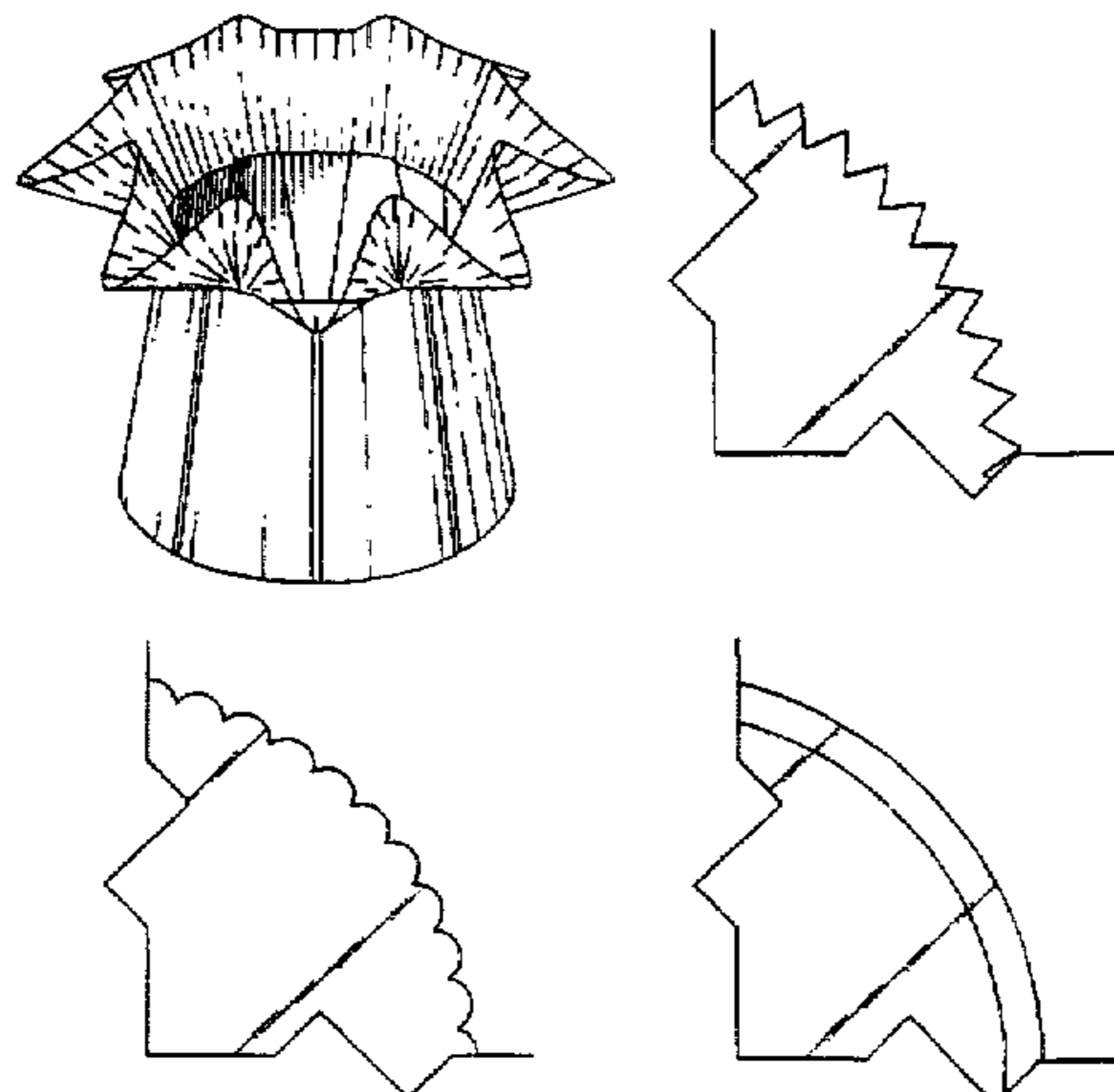

FIG. 17 is a side elevational view of the design of FIG. 11, the only difference being in the downward angle of the skirt;
FIG. 18 is a fragmentary enlarged top plan view of a sixth embodiment of the design of FIG. 11, the only difference being in the skirt edge;

FIG. 19 is a fragmentary enlarged top plan view of a seventh embodiment of the design of FIG. 11, the only difference being in the skirt edge;

FIG. 20 is a fragmentary enlarged top plan view of an eighth embodiment of the design of FIG. 11, the only difference being in the skirt edge;

FIG. 21 is a perspective view of a ninth embodiment of our new flower pot cover design;

FIG. 22 is a side elevational view thereof;

FIG. 23 is a top plan view thereof;

FIG. 24 is a bottom plan view thereof;

FIG. 25 is a side elevational view of the design of FIG. 21, the only difference being in the horizontal angle of the skirt;

FIG. 26 is a side elevational view of the design of FIG. 21, the only difference being in the near vertical angle of the skirt;

FIG. 27 is a side elevational view of the design of FIG. 21, the only difference being in the downward angle of the skirt;

FIG. 28 is a fragmentary enlarged top plan view of a tenth embodiment of the design of FIG. 21, the only difference being in the skirt edge;

FIG. 29 is a fragmentary enlarged top plan view of an eleventh embodiment of the design of FIG. 21, the only difference being in the skirt edge; and,

FIG. 30 is a fragmentary enlarged top plan view of a twelfth embodiment of the design of FIG. 21, the only difference being in the skirt edge.

1 Claim, 6 Drawing Sheets

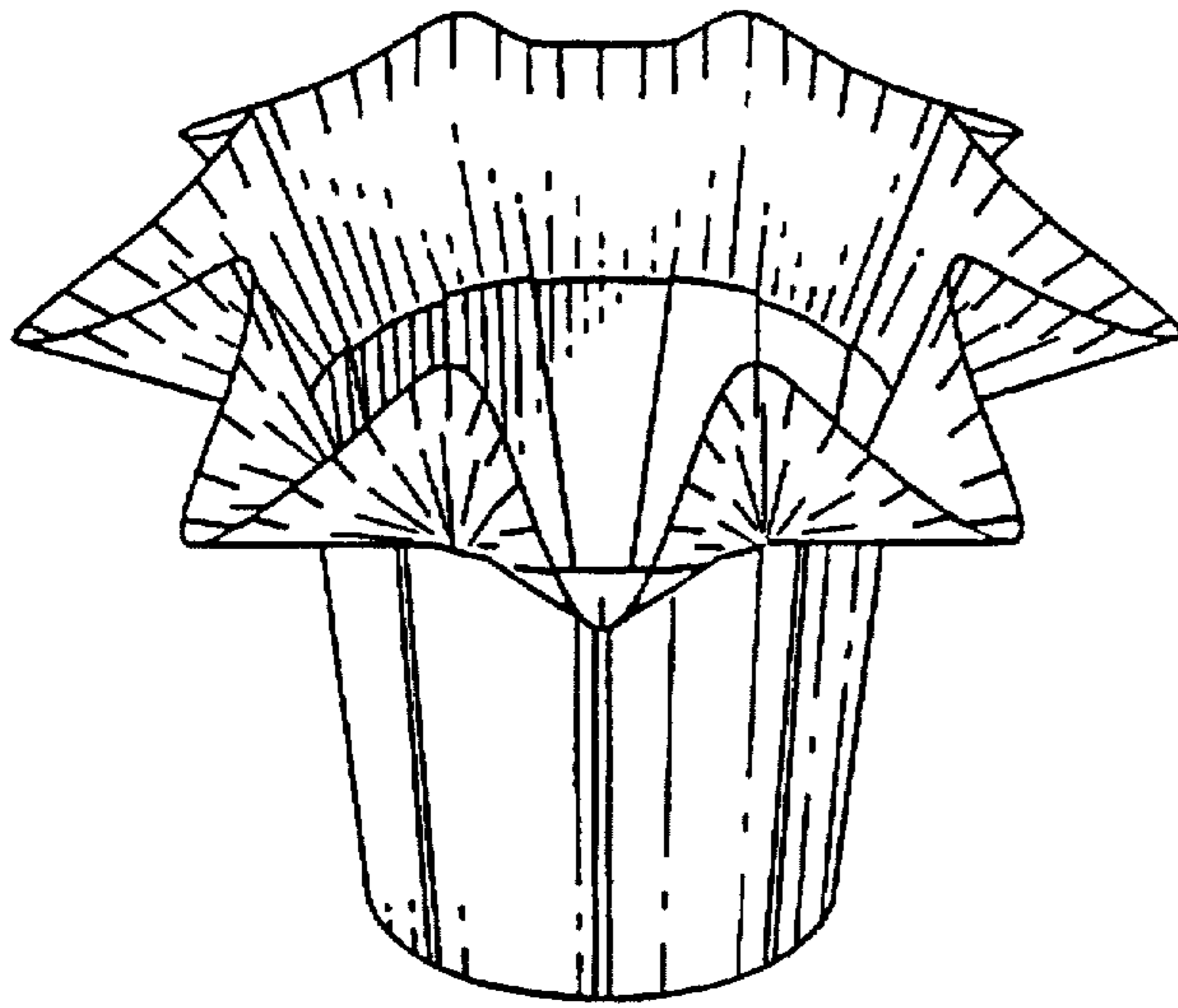

Fig. 1

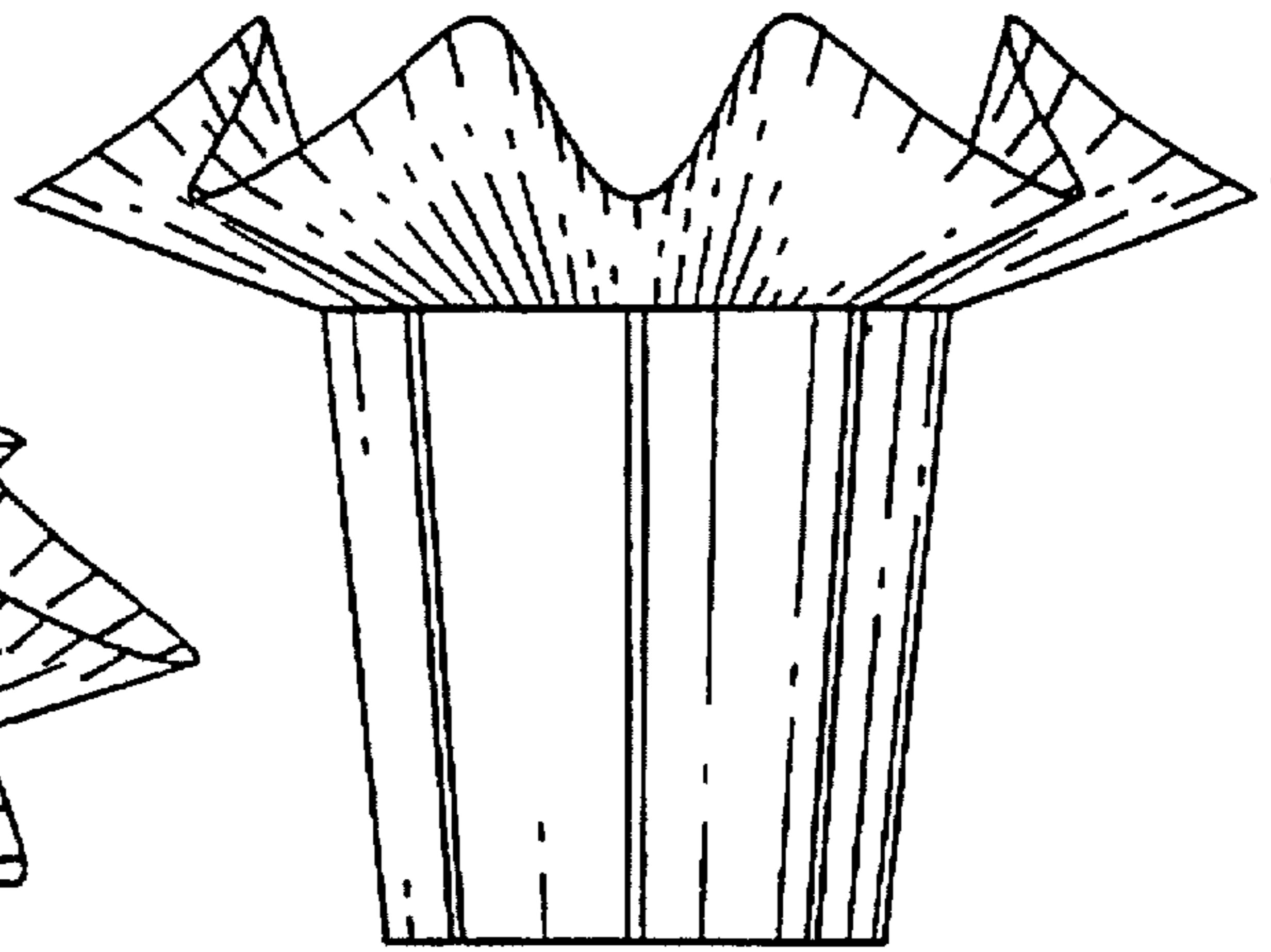

Fig. 2

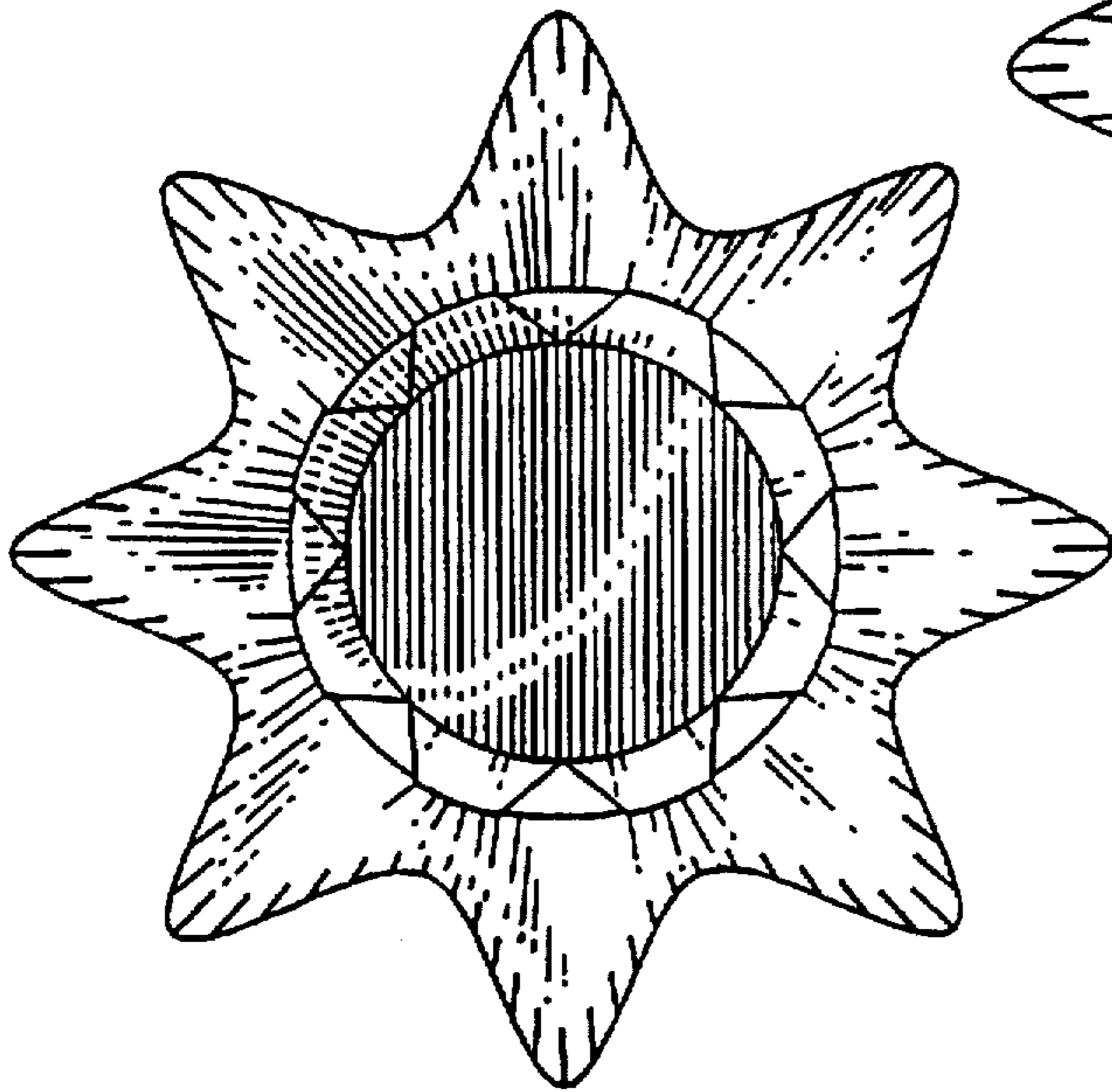

Fig. 3

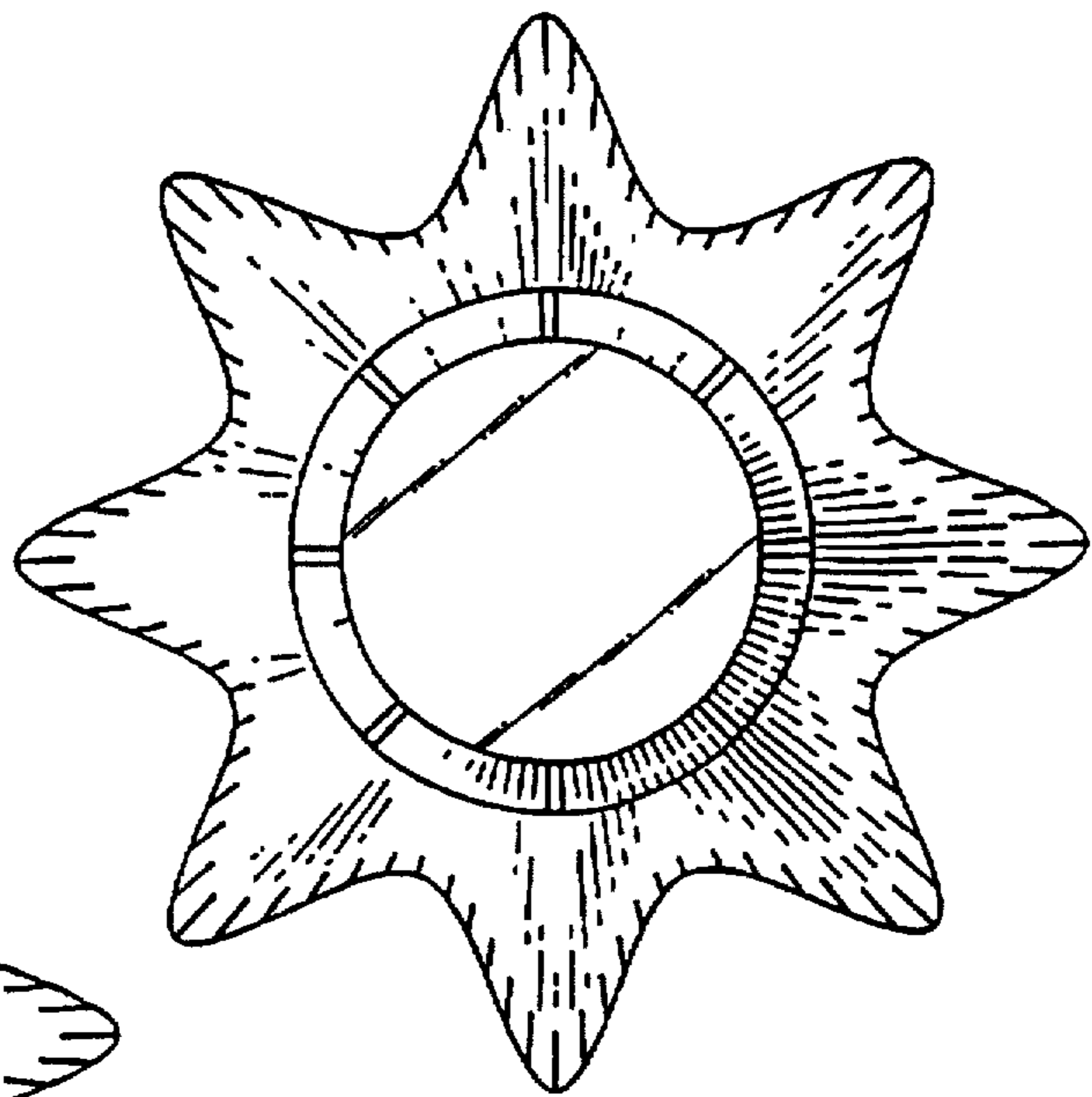

Fig. 4

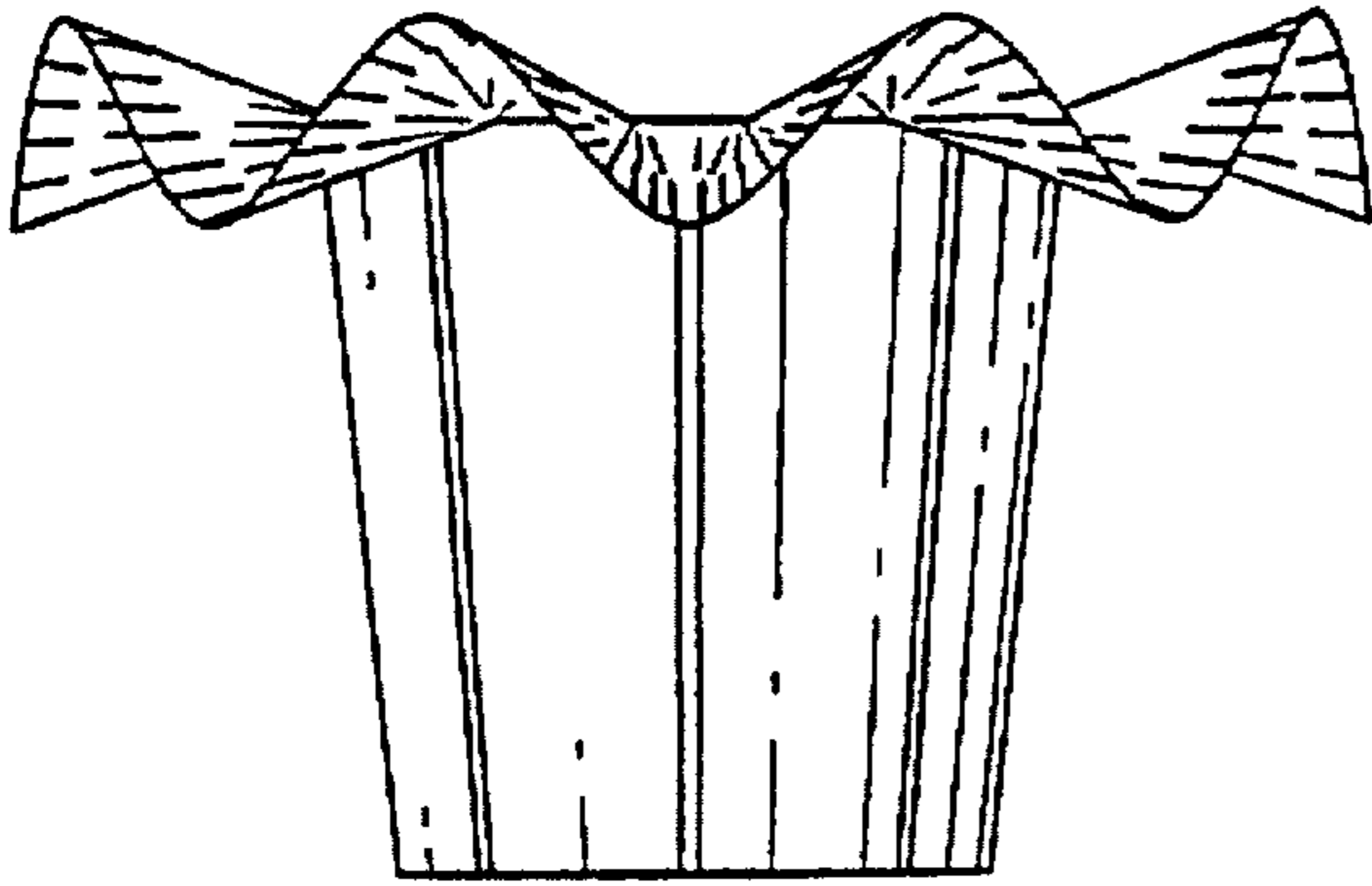

Fig. 5

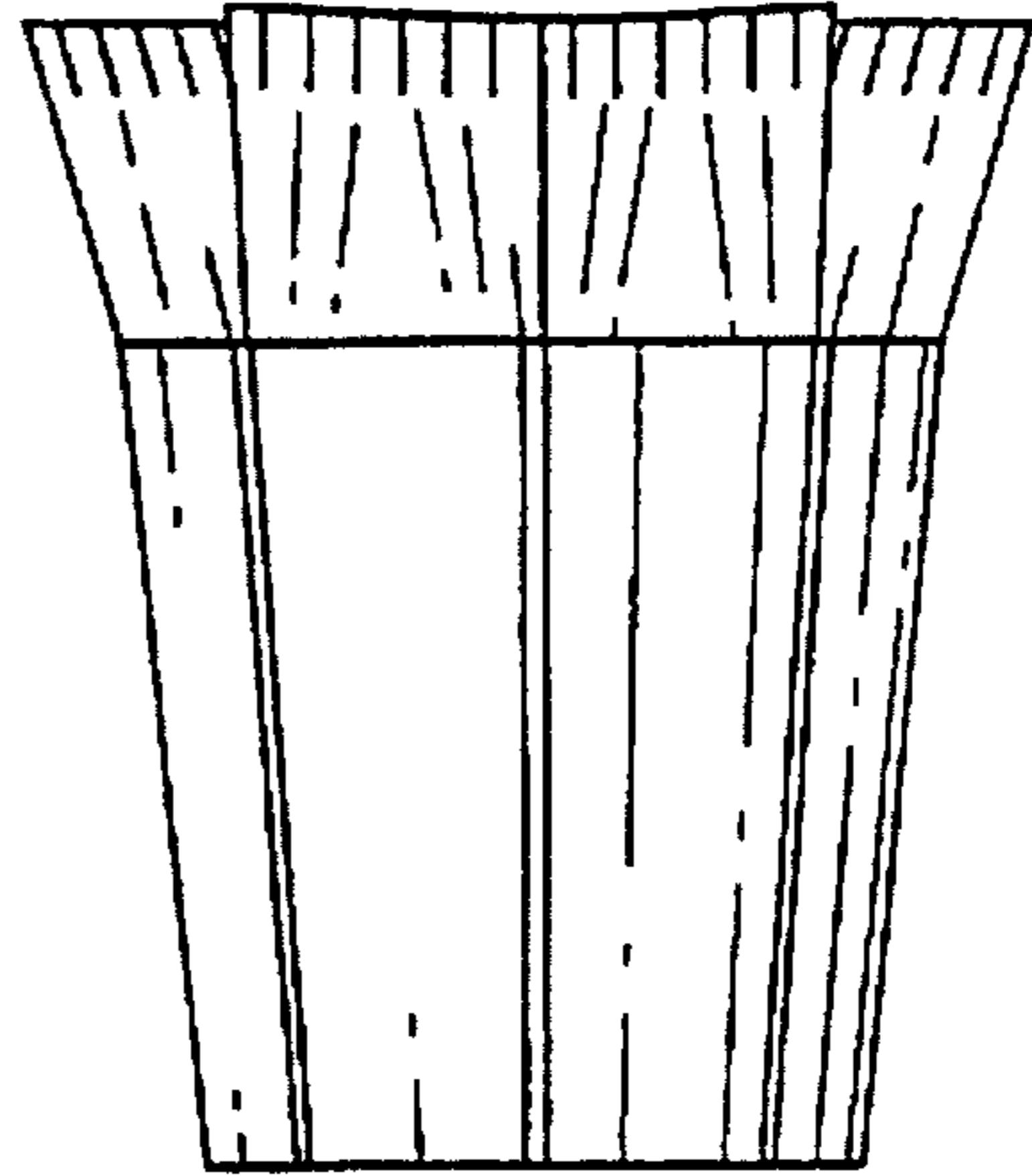

Fig. 6

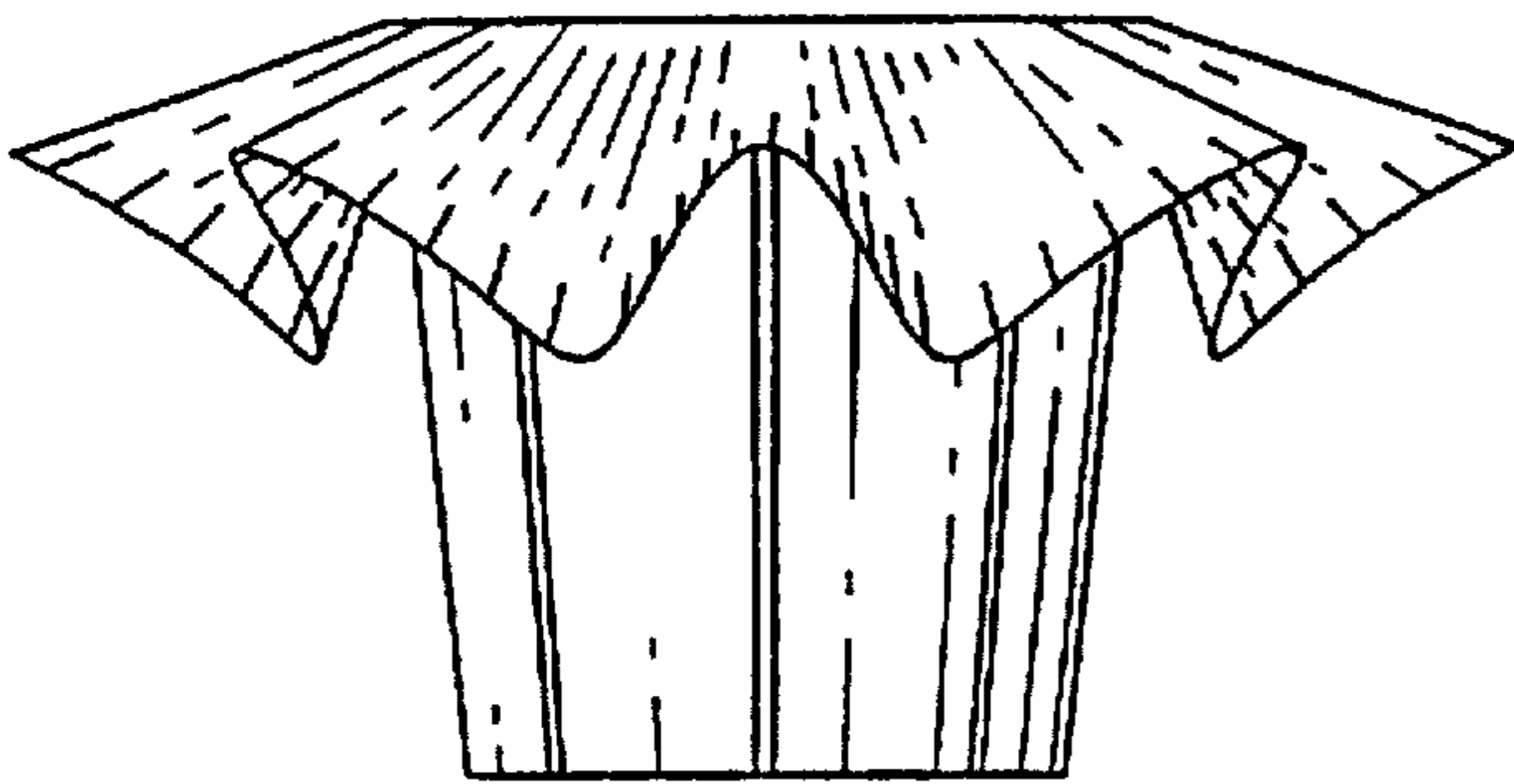

Fig. 7

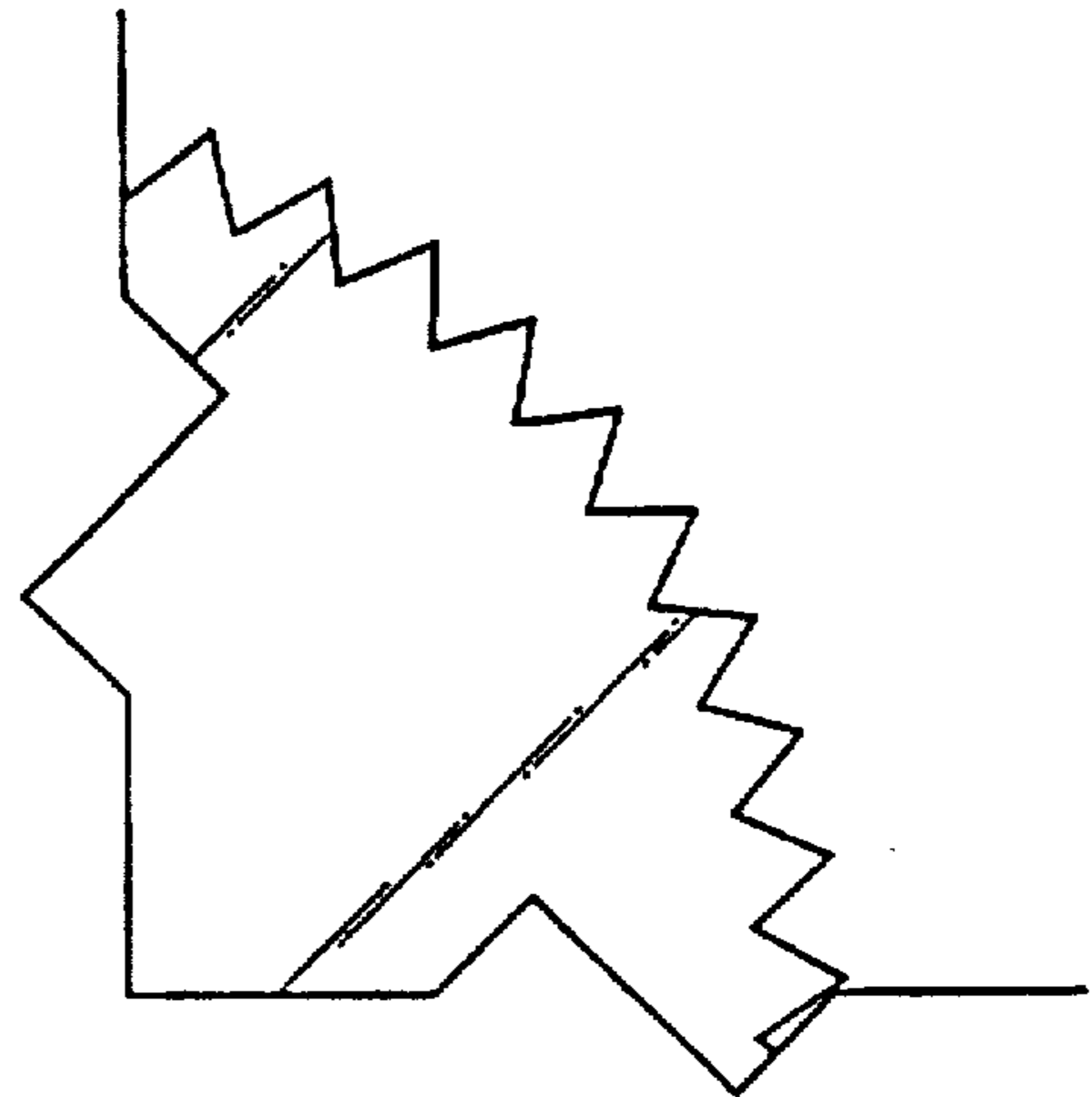

Fig. 8

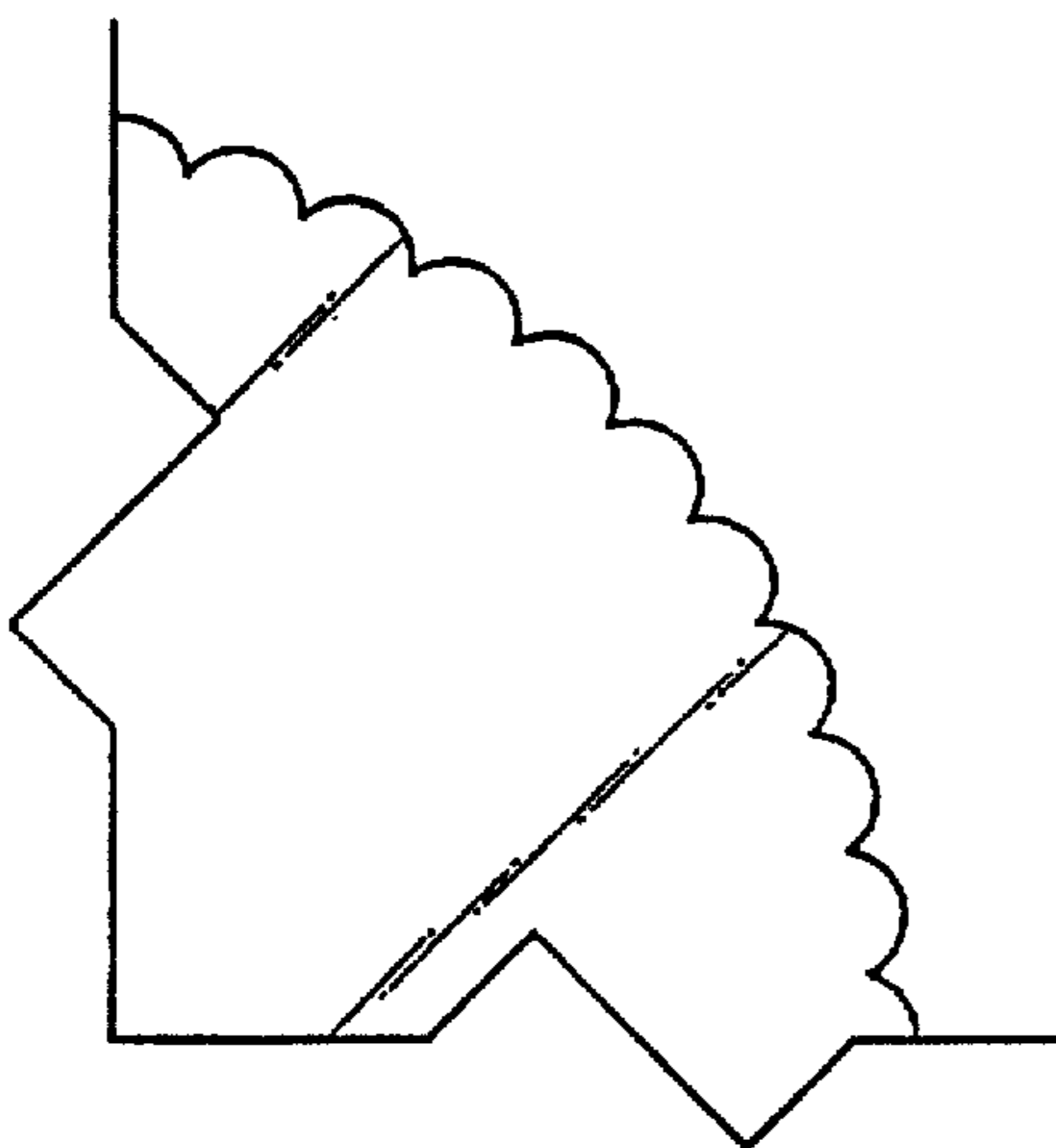

Fig. 9

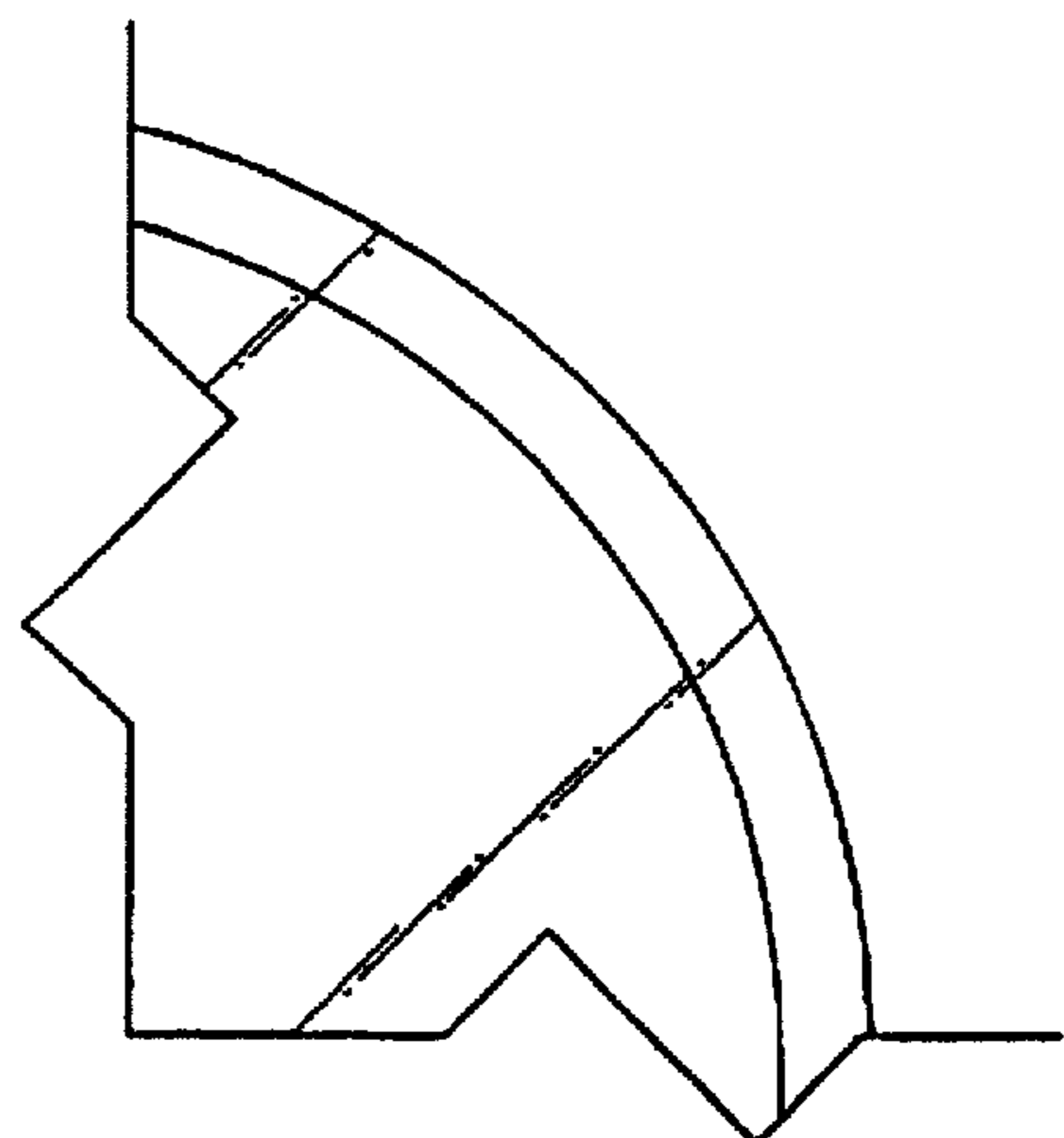

Fig. 10

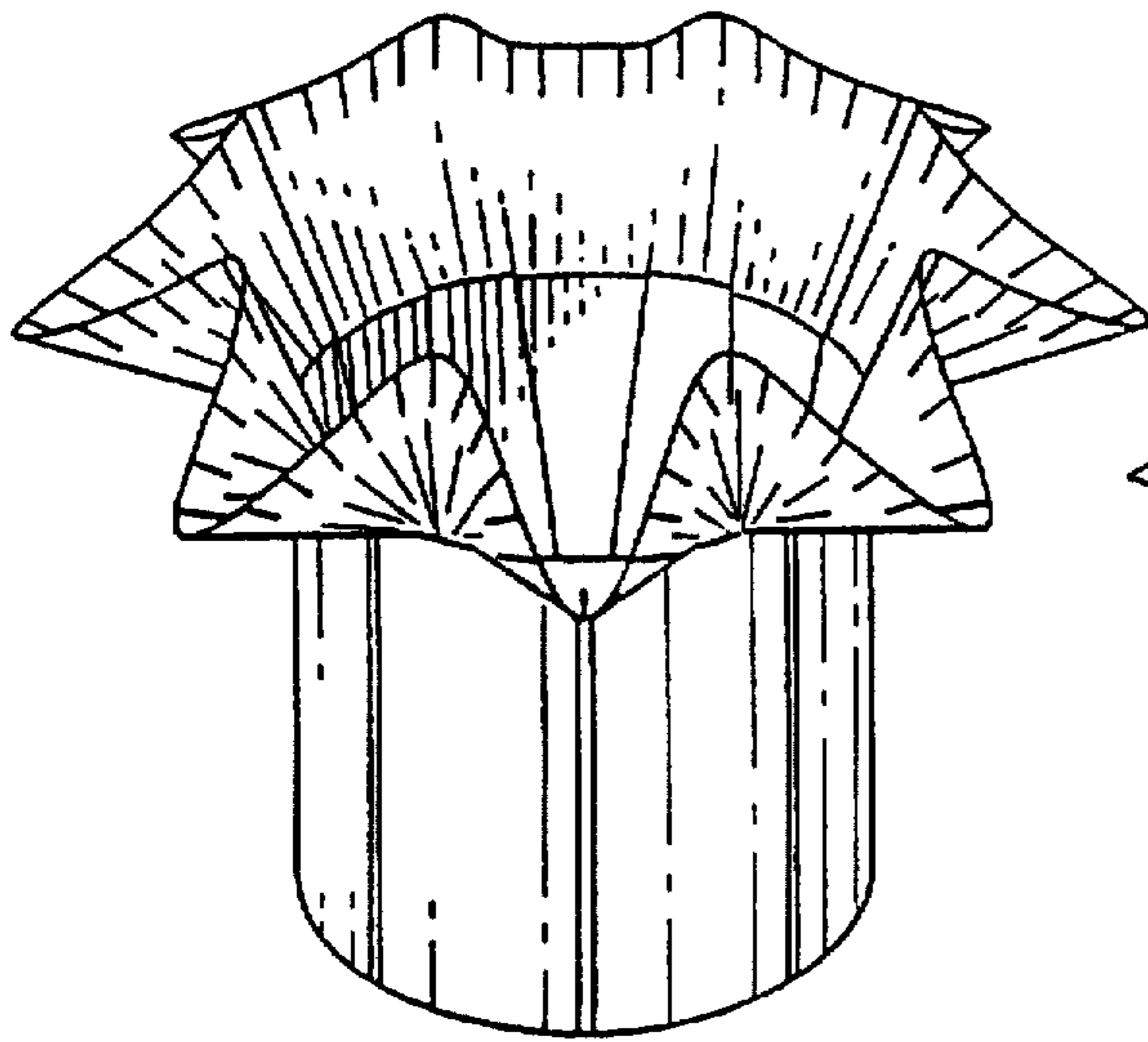

Fig. 11

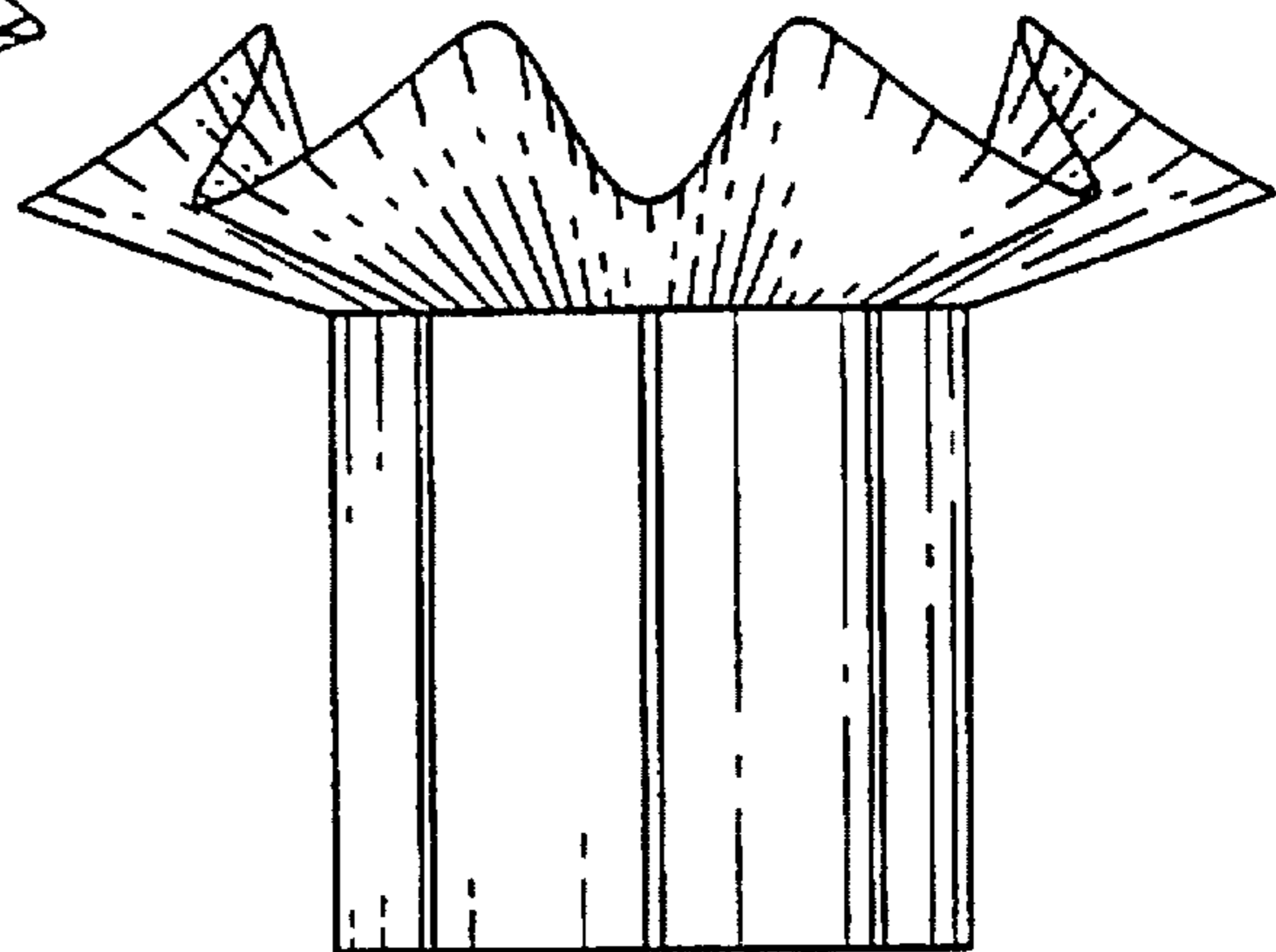

Fig. 12

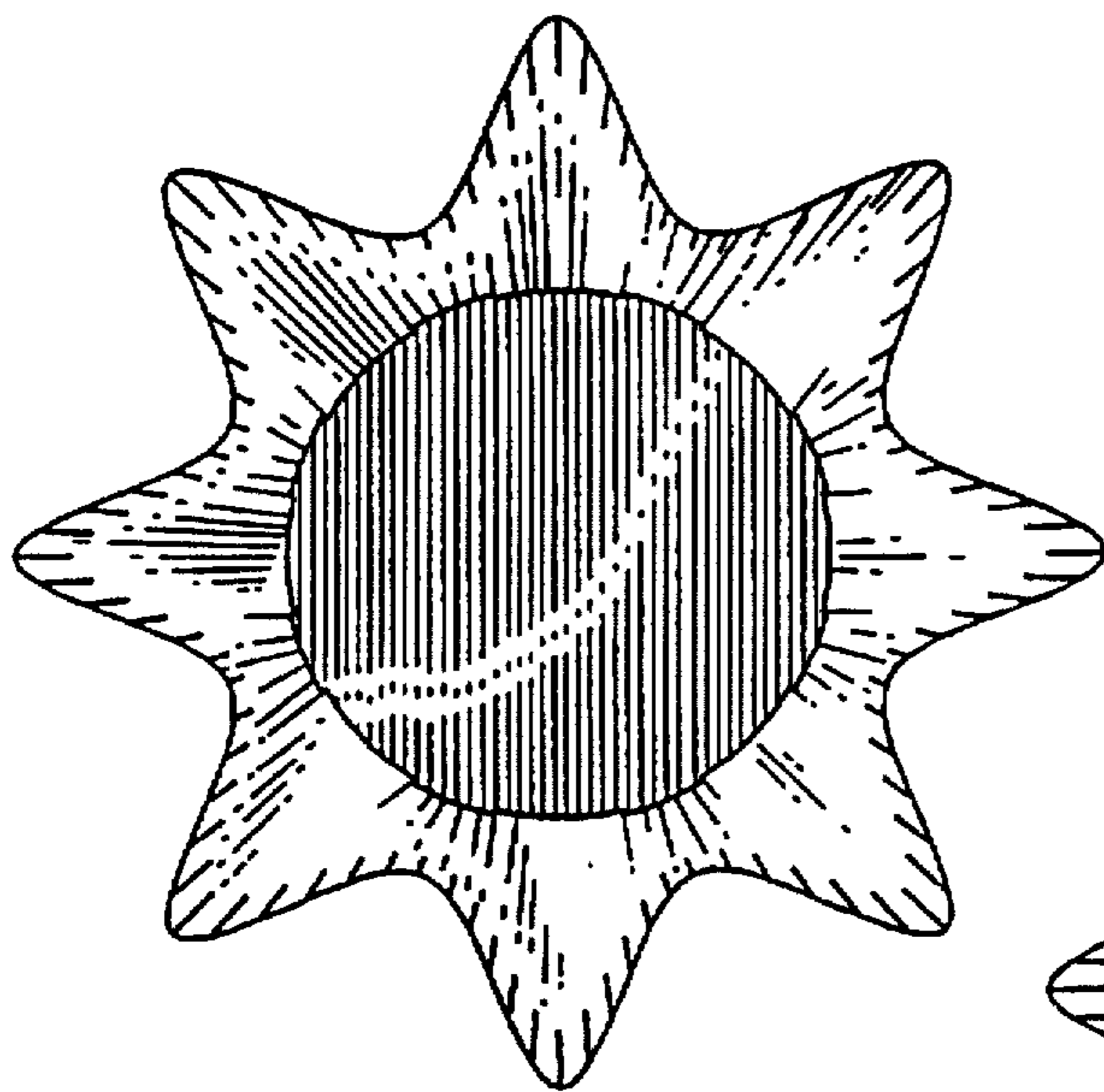

Fig. 13

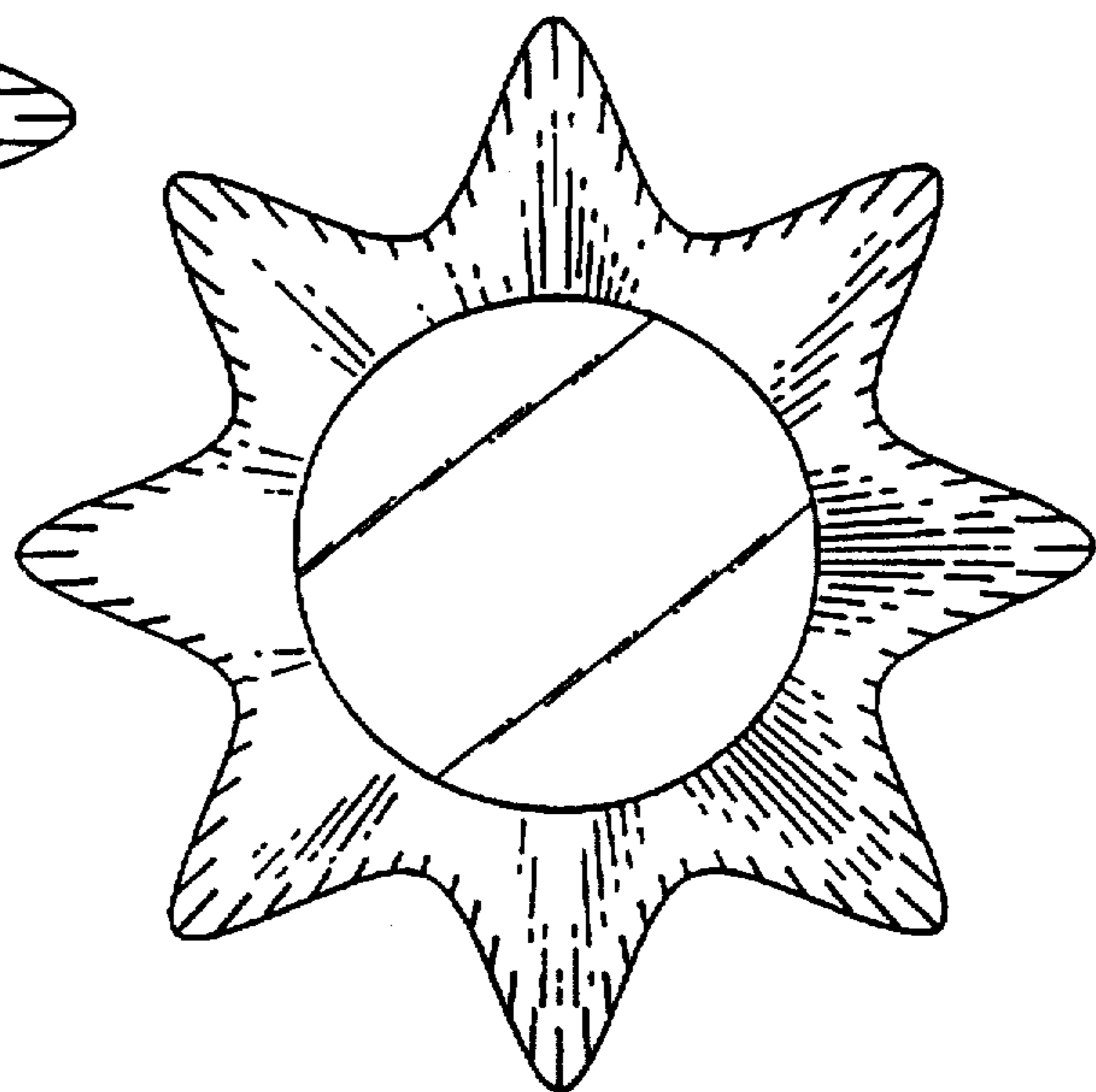

Fig. 14

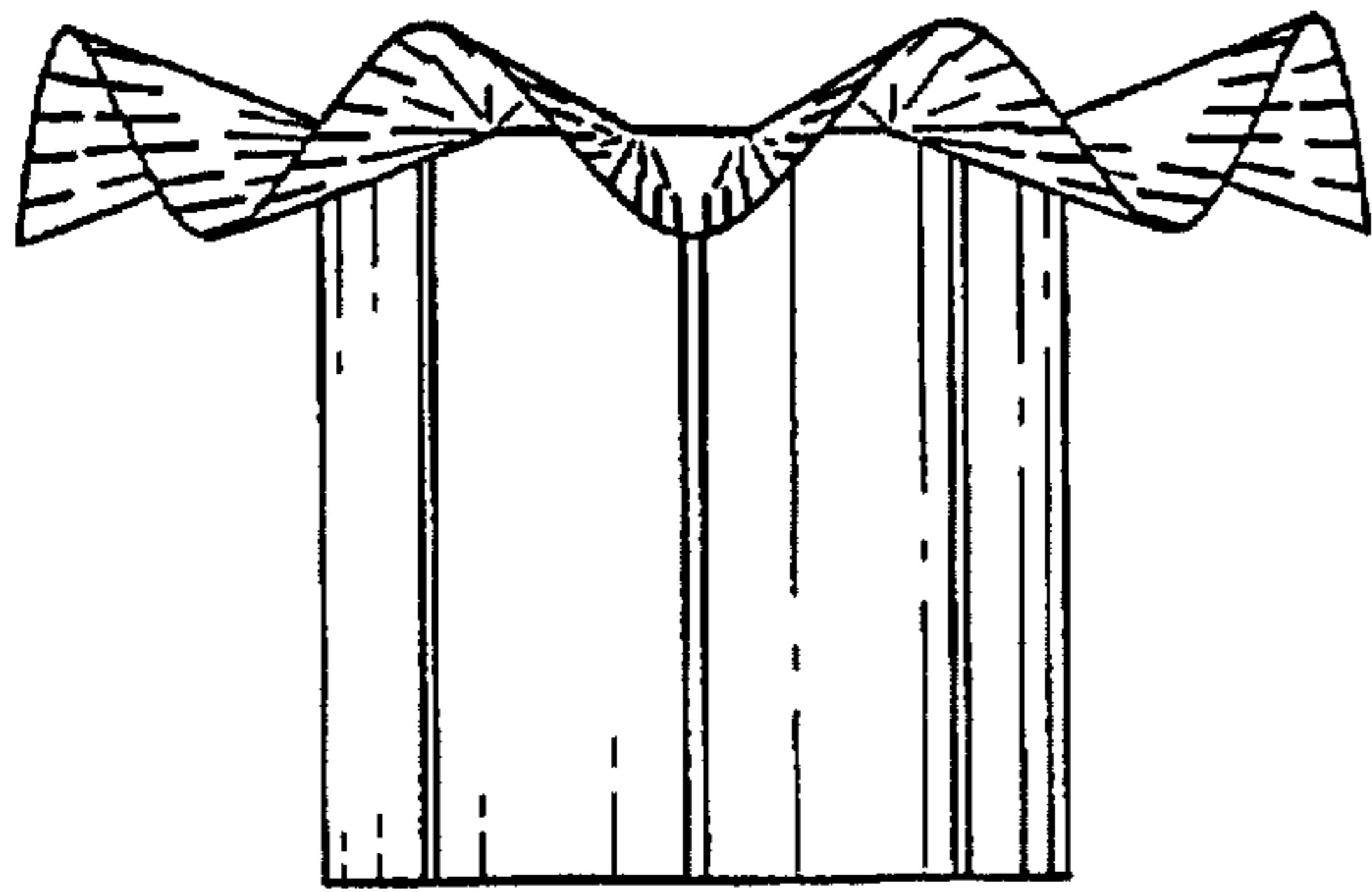

Fig. 15

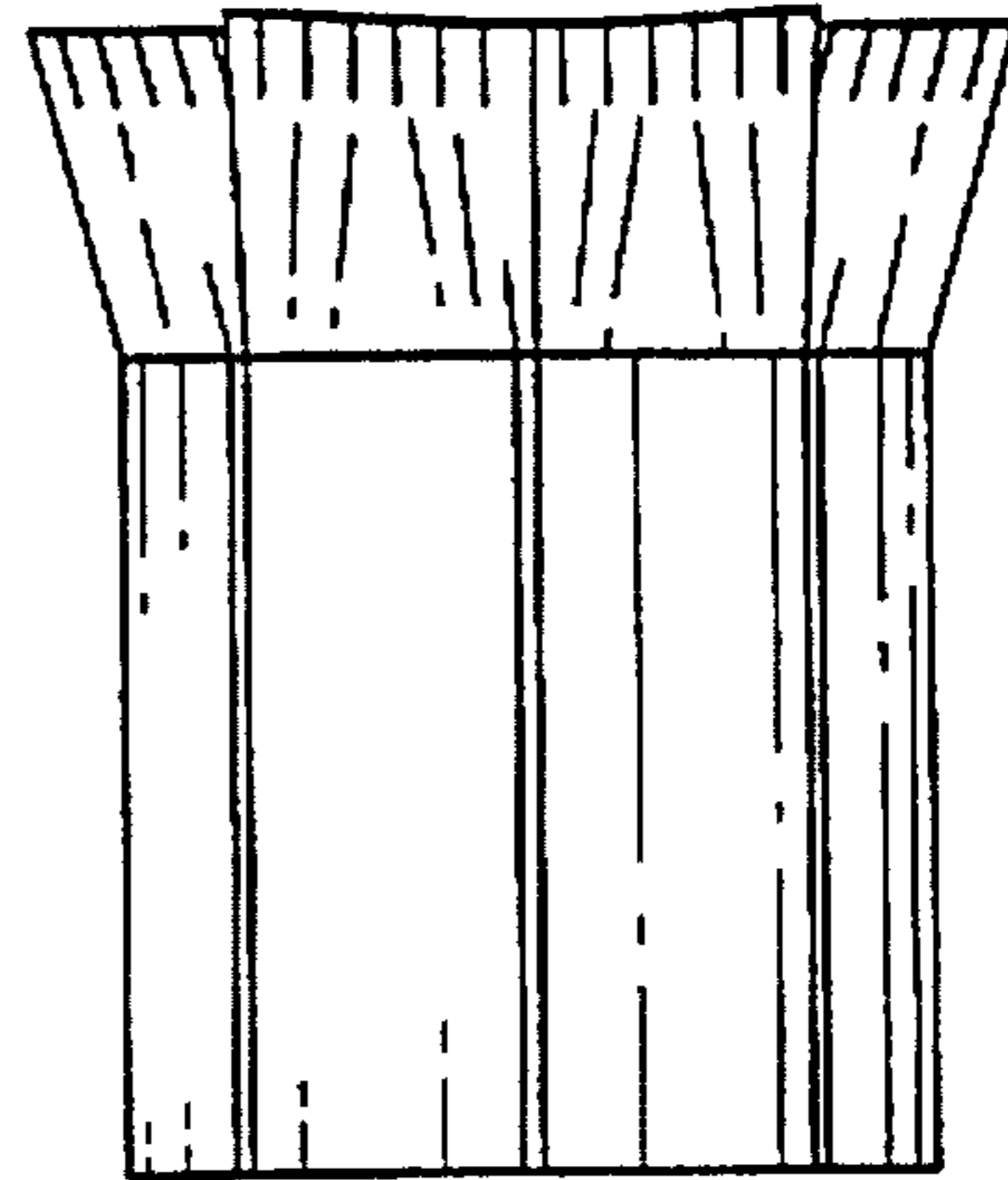

Fig. 16

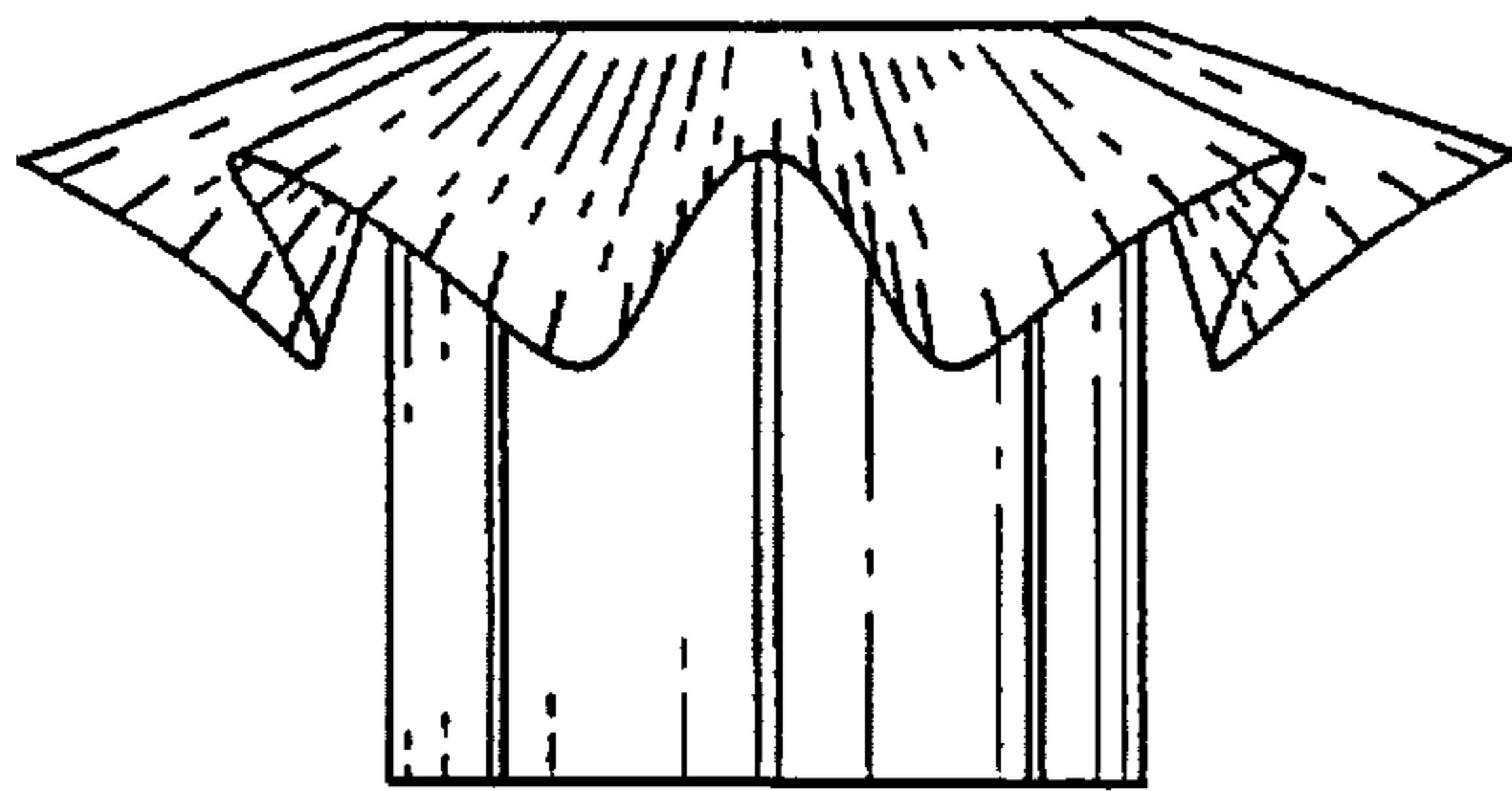

Fig. 17

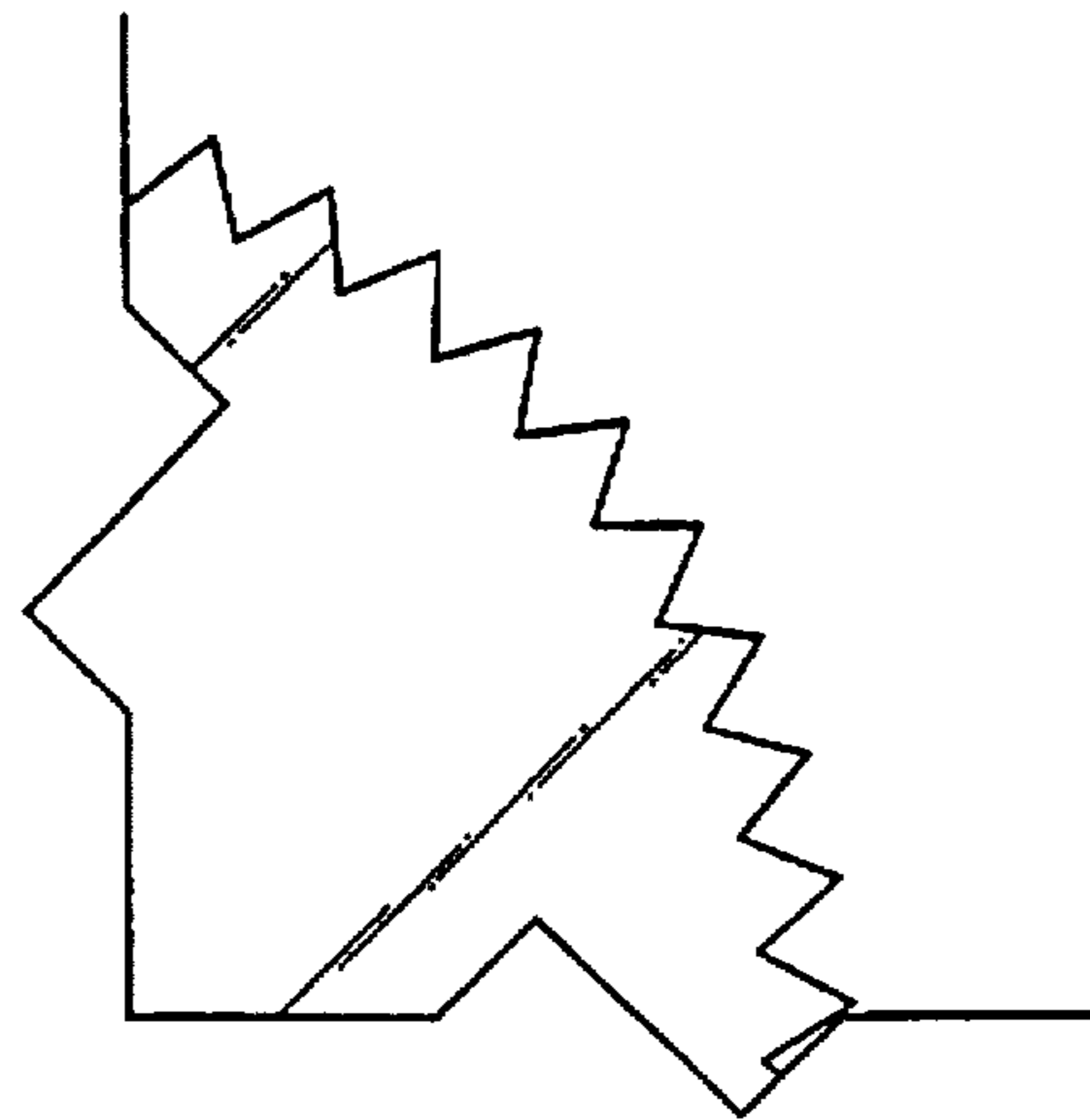

Fig. 18

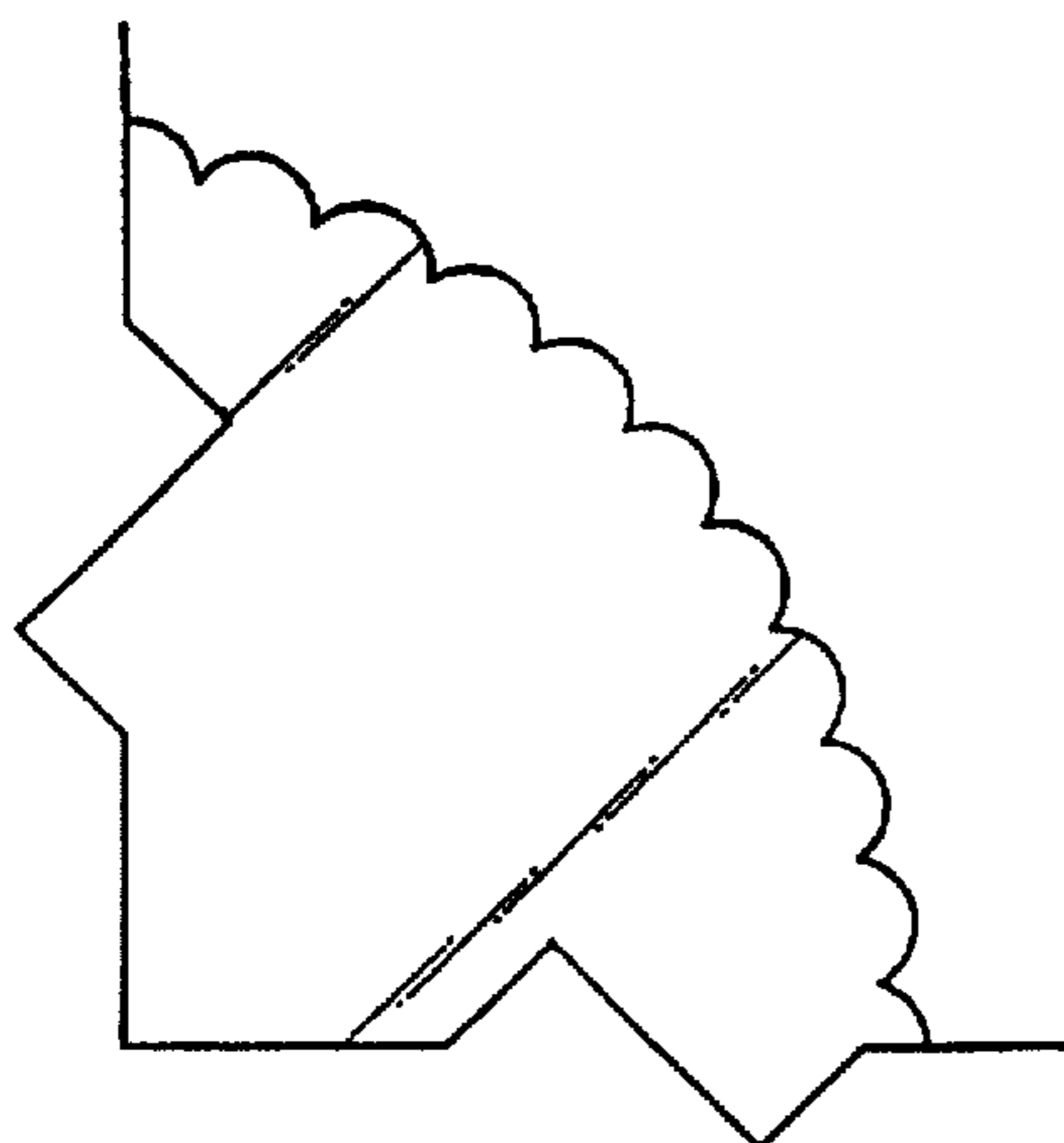

Fig. 19

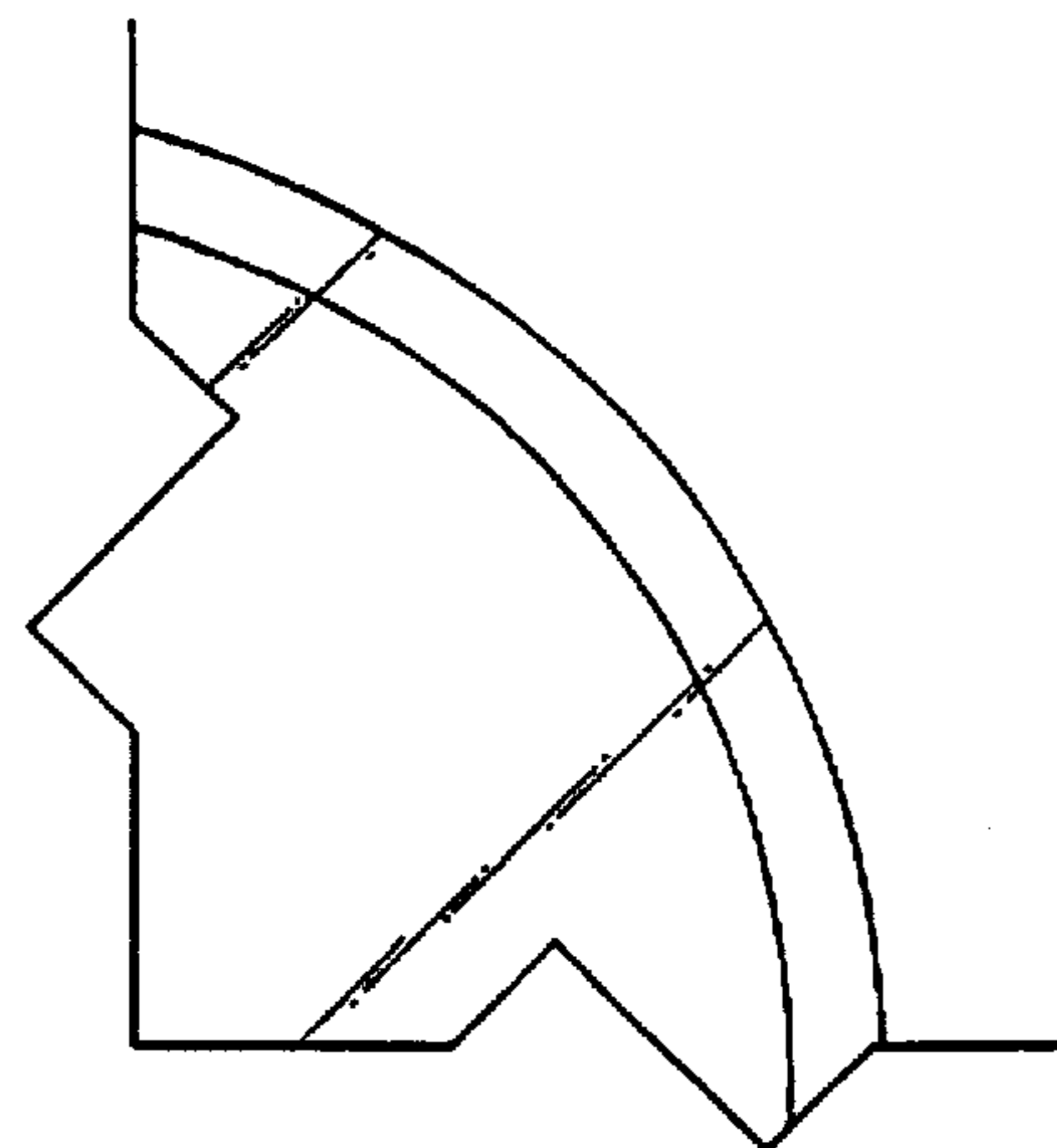

Fig. 20

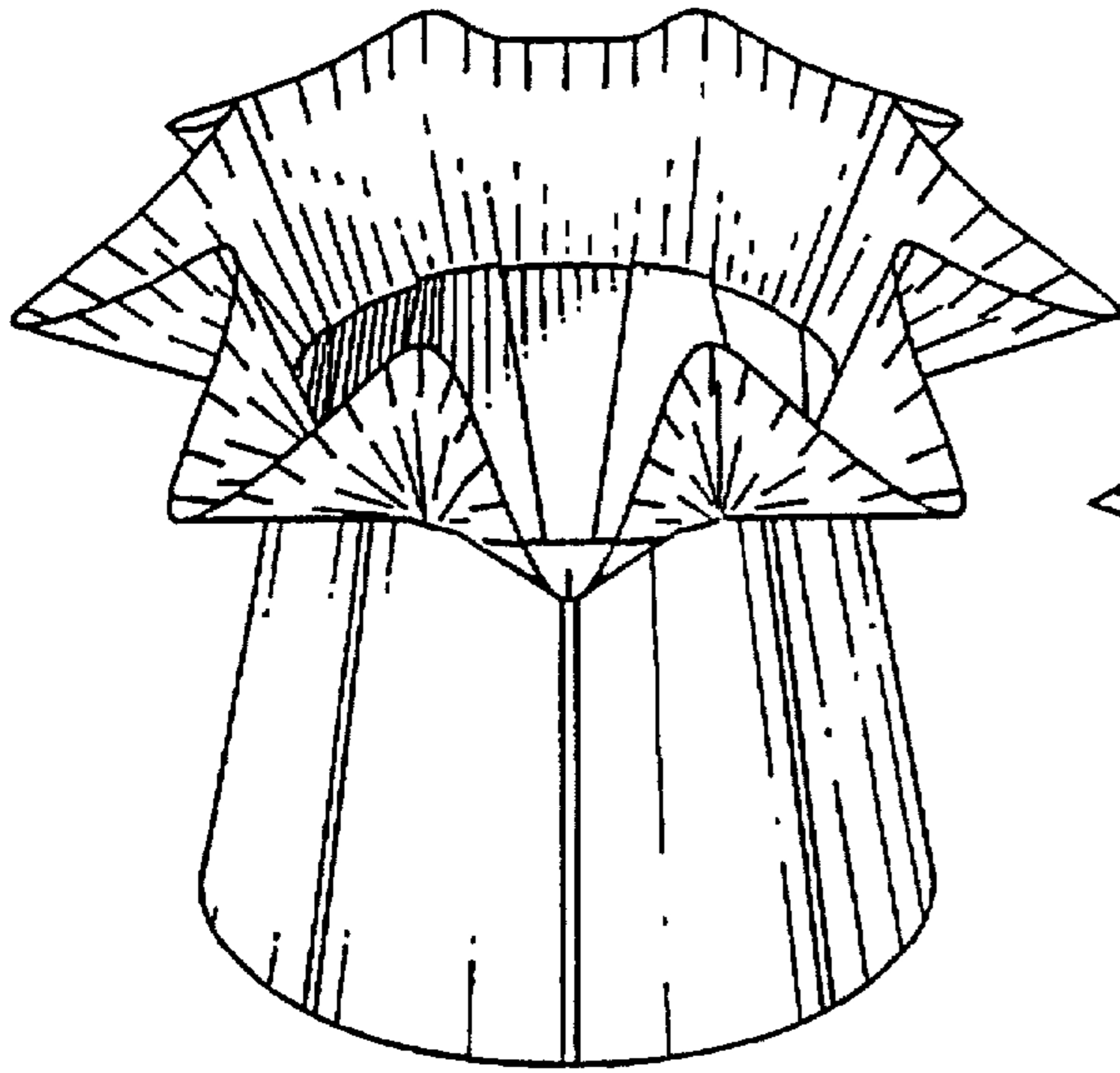

Fig. 21

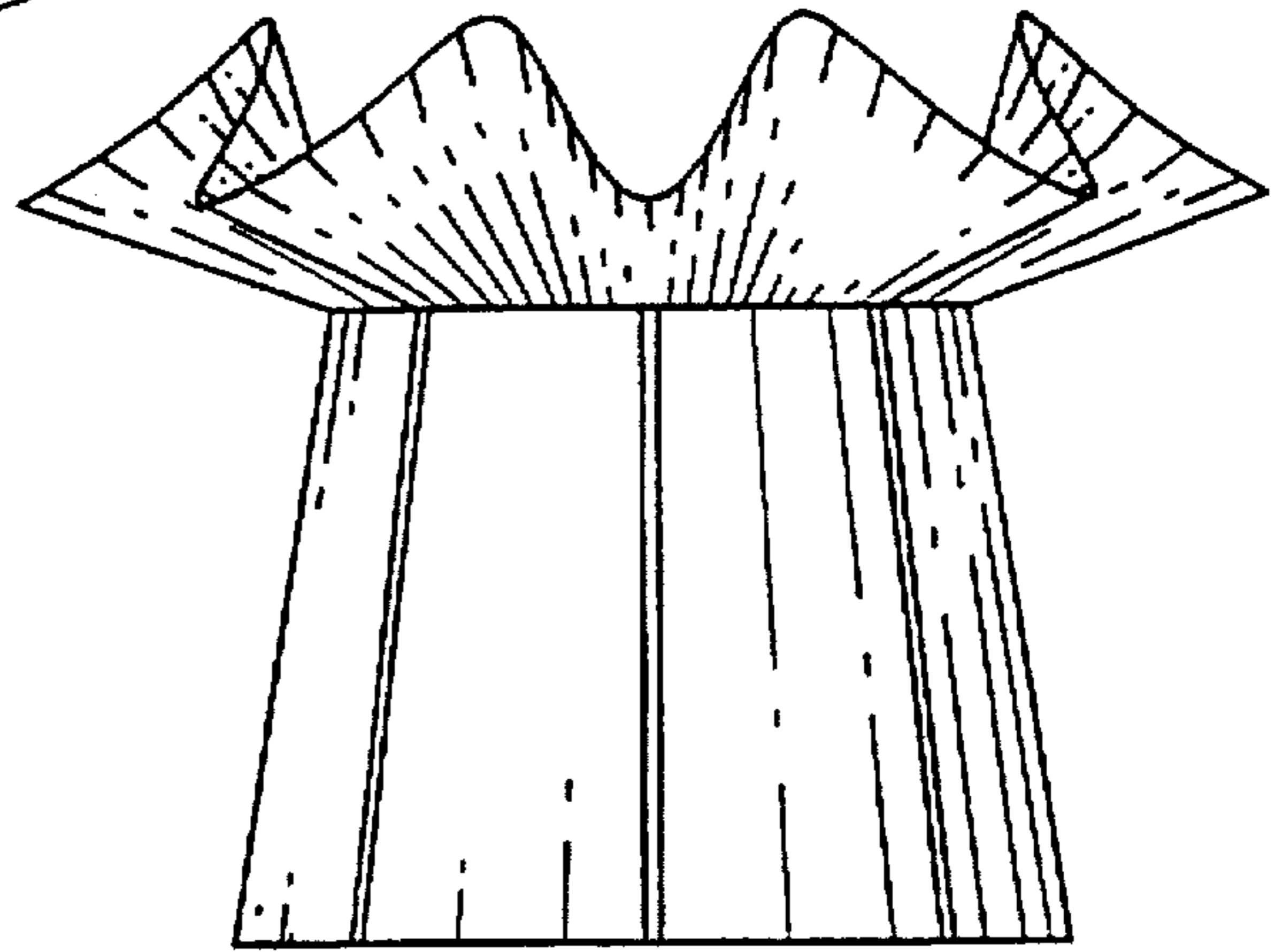

Fig. 22

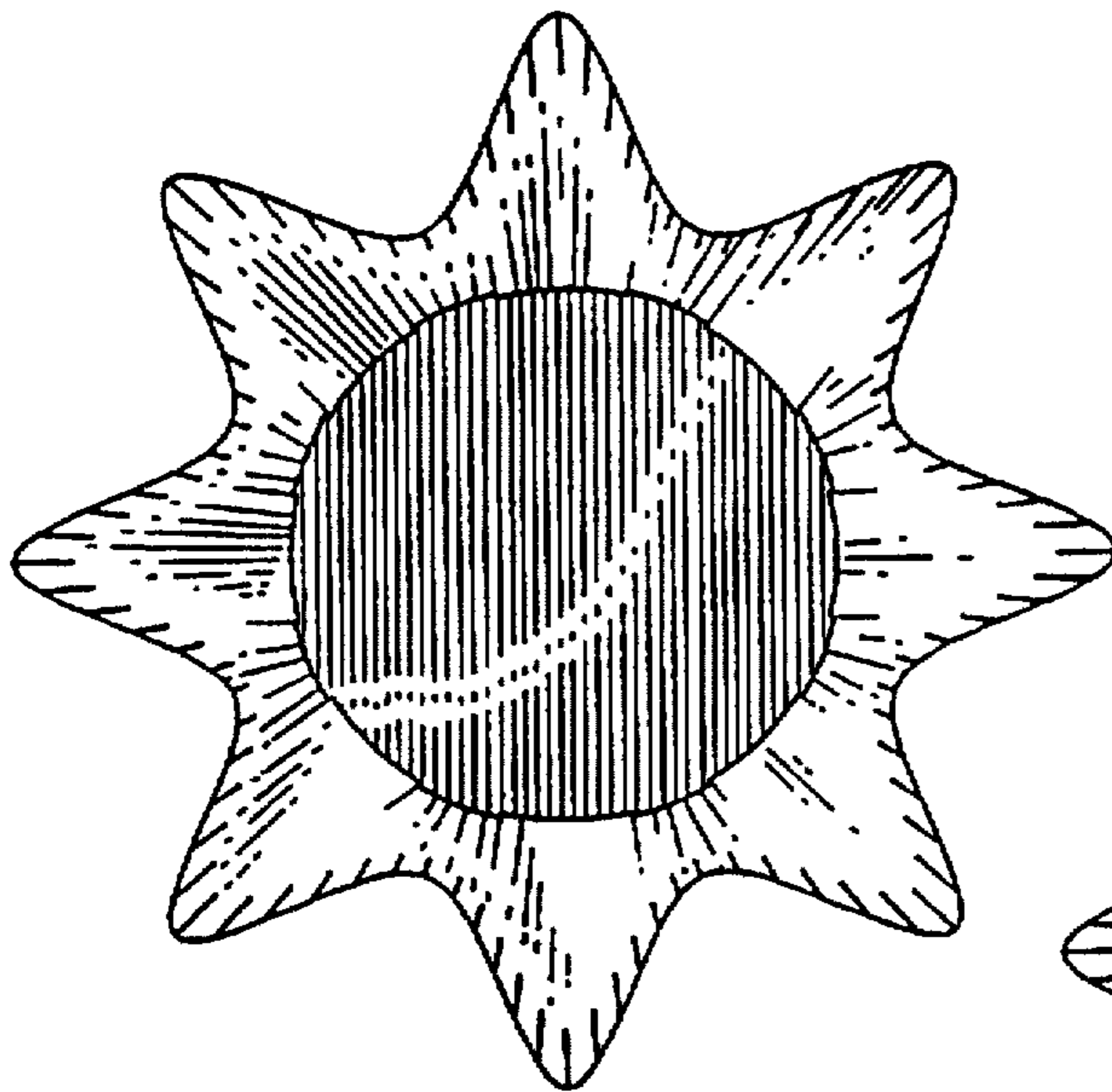

Fig. 23

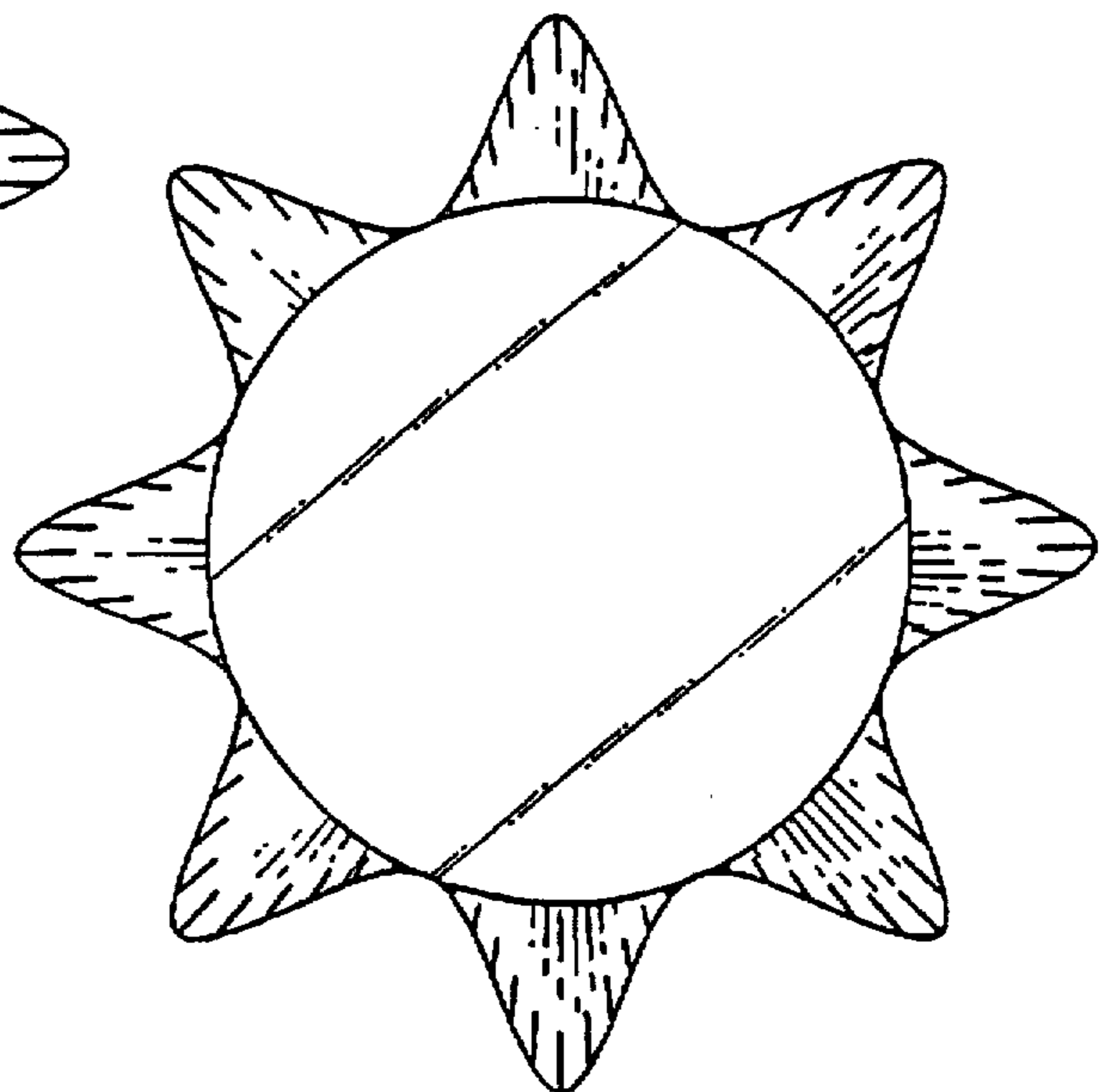

Fig. 24

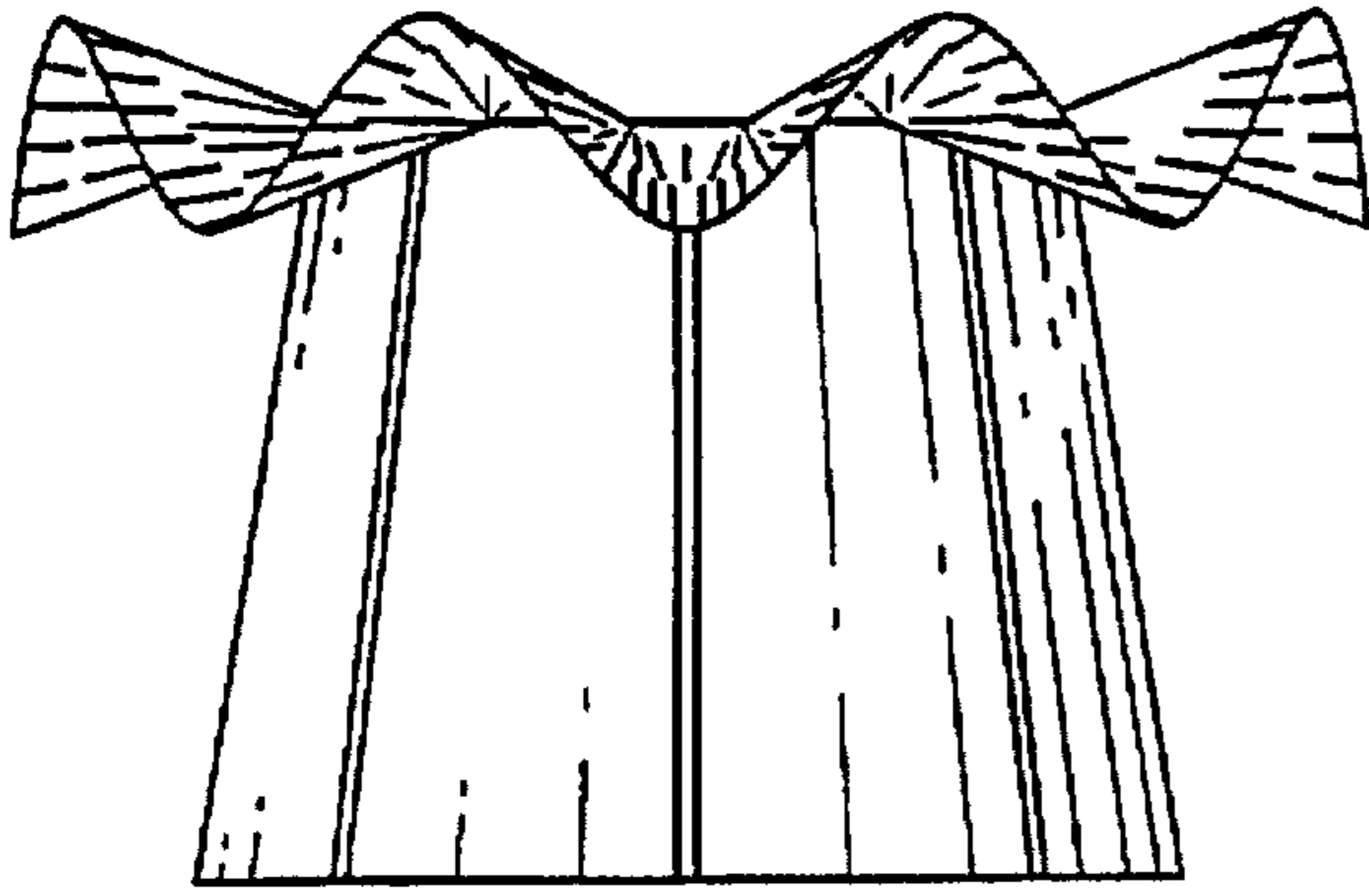

Fig. 25

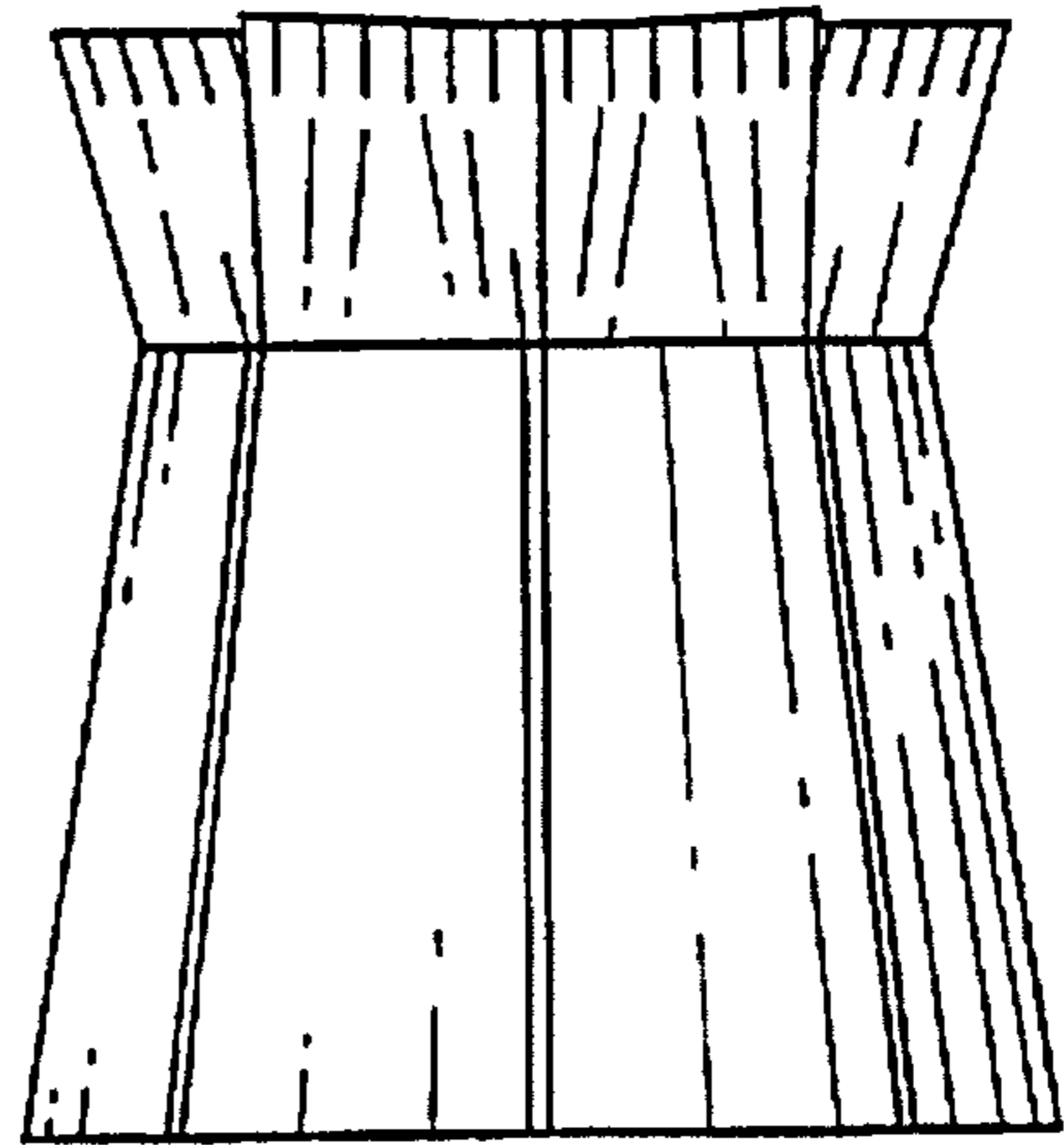

Fig. 26

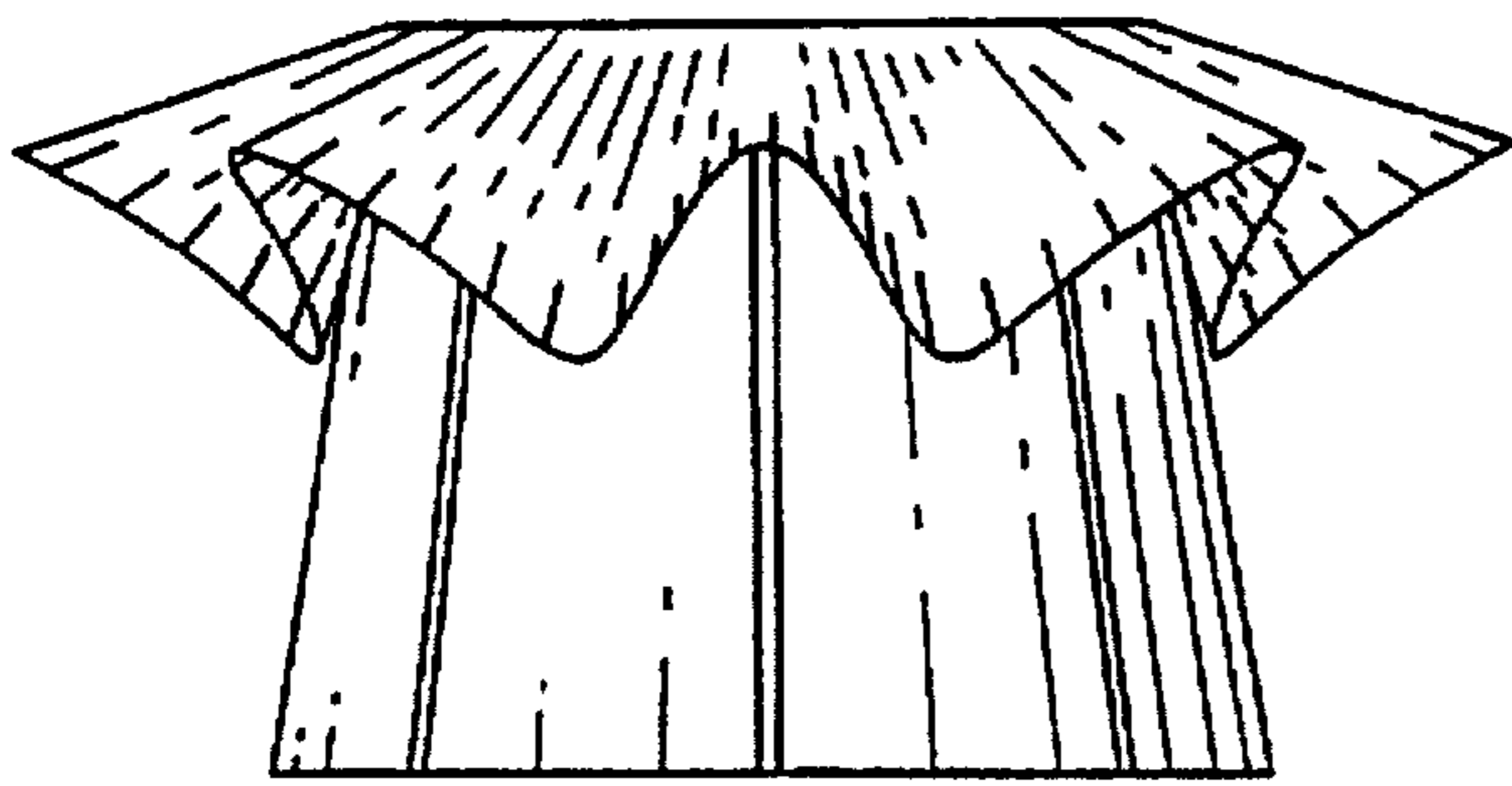

Fig. 27

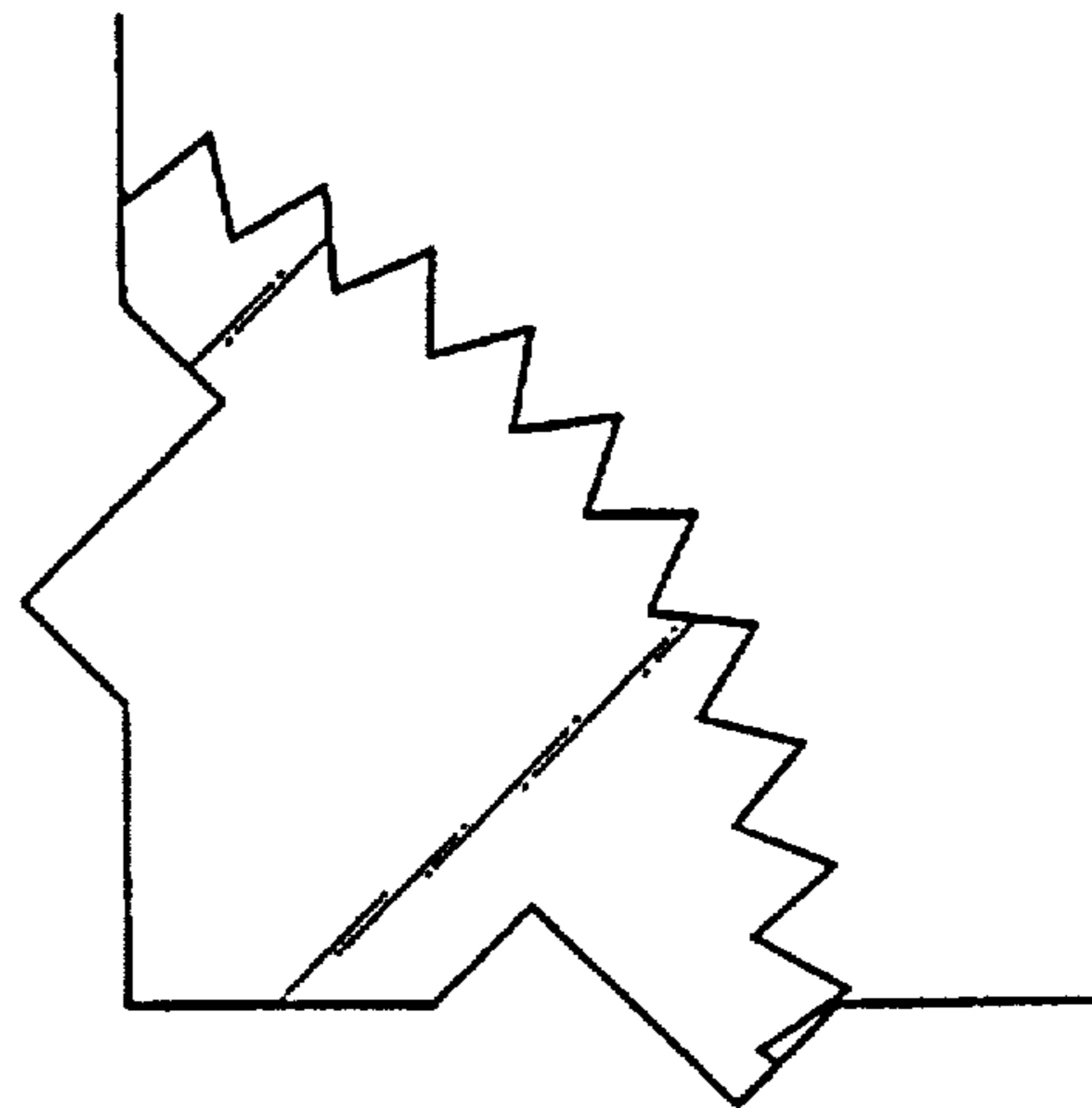

Fig. 28

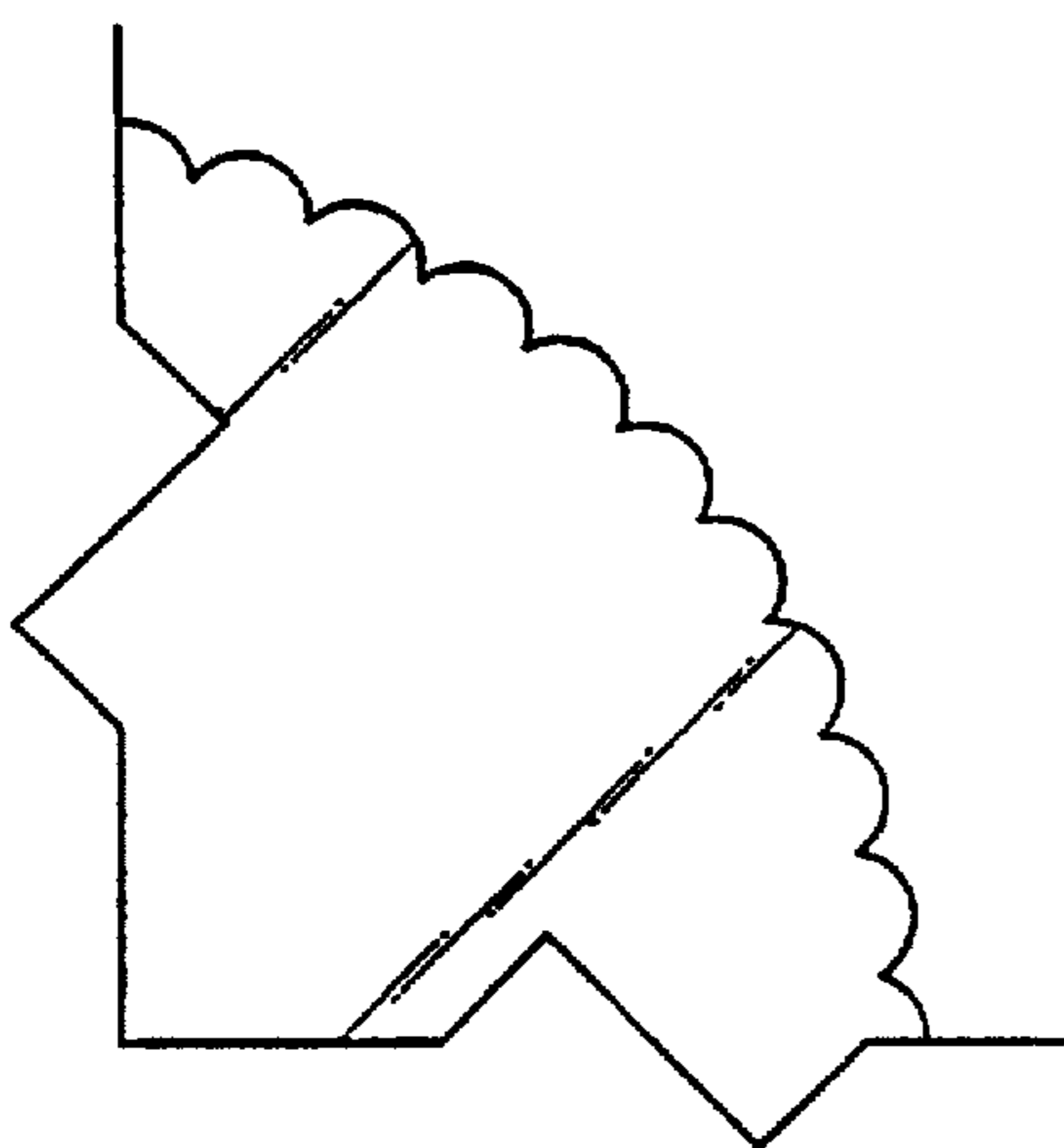

Fig. 29

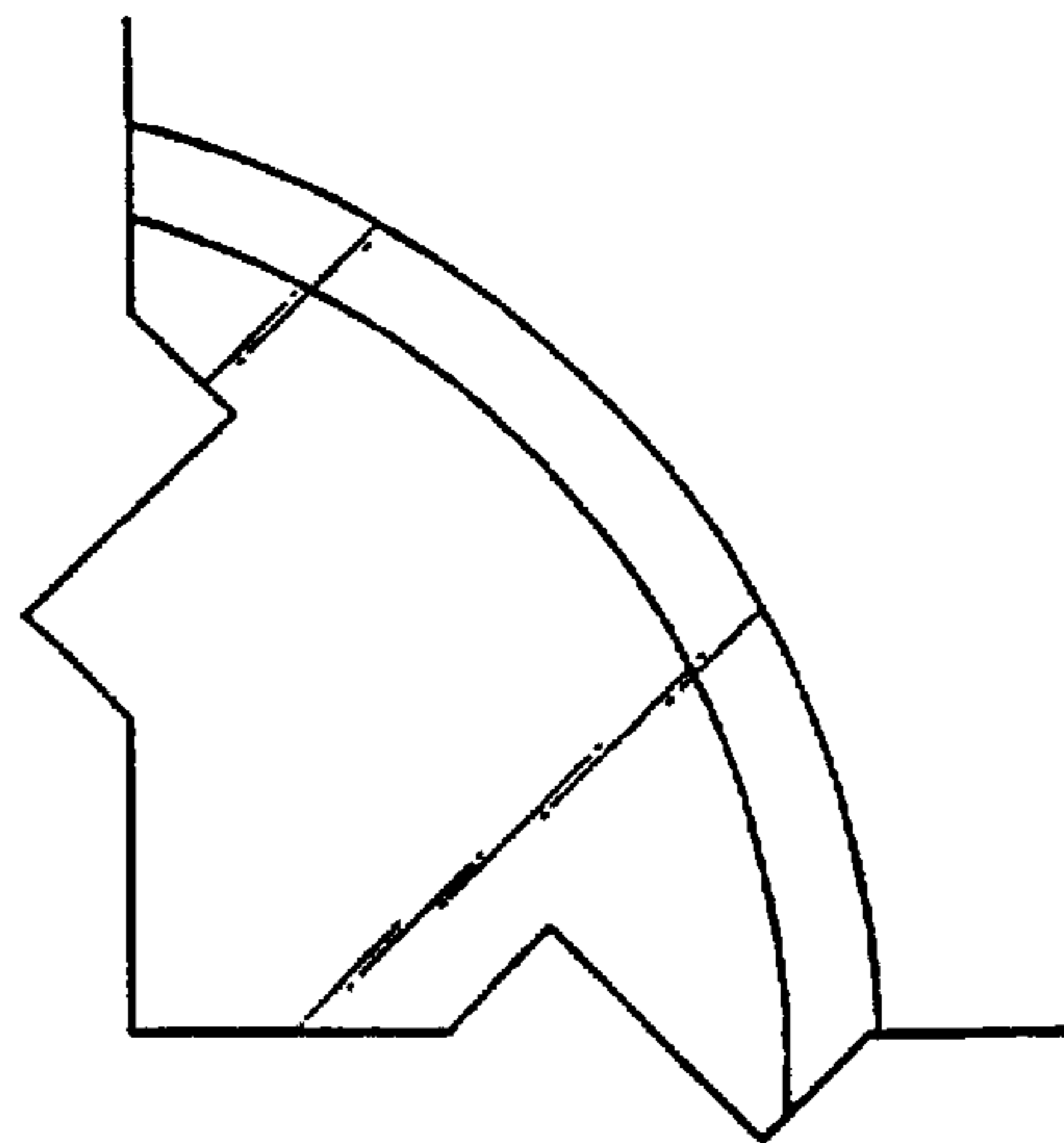

Fig. 30

UNITED STATES PATENT AND TRADEMARK OFFICE
CERTIFICATE OF CORRECTION

PATENT NO. : Des. 380,176
DATED : June 24, 1997
INVENTOR(S) : Donald E. Weder et al.

It is certified that error appears in the above-identified patent and that said Letters Patent is hereby corrected as shown below:

Cover Sheet, Section [60] Related U.S. Application Data;
line 5, please delete "365,382", and substitute therefor
--365,302--.

Signed and Sealed this
Sixteenth Day of September, 1997

Attest:



BRUCE LEHMAN

Attesting Officer

Commissioner of Patents and Trademarks