



US00D380113S

**United States Patent** [19]  
**Byrd**

[11] **Patent Number: Des. 380,113**  
[45] **Date of Patent: \*\*Jun. 24, 1997**

[54] **CAN DISPENSER AND HOLDER**  
[75] **Inventor: Chris Byrd, Winston-Salem, N.C.**  
[73] **Assignee: Chesapeake Display and Packaging Company, Winston-Salem, N.C.**  
[\*\*] **Term: 14 Years**  
[21] **Appl. No.: 48,976**  
[22] **Filed: Jan. 11, 1996**  
[51] **LOC (6) Cl. .... 07-07**  
[52] **U.S. Cl. .... D6/515; D6/515**  
[58] **Field of Search ..... D6/515, 517; D7/601, D7/602, 701; 211/59.2, 74, 181, 182**

3,178,242 4/1965 Ellis et al. .  
4,530,548 7/1985 Spamer et al. .  
4,598,828 7/1986 Young et al. .... 211/59.2  
5,289,943 3/1994 Powell .

*Primary Examiner*—Brian N. Vinson  
*Attorney, Agent, or Firm*—Bell, Seltzer, Park & Gibson, P.A.

[57] **CLAIM**

The ornamental design for a can dispenser and holder, as shown and described.

**DESCRIPTION**

FIG. 1 is a top, front, and right side perspective view of a can dispenser and holder showing the first embodiment of my design;  
FIG. 2 is a right side elevation view thereof;  
FIG. 3 is a top elevation view thereof;  
FIG. 4 is a bottom elevation view thereof;  
FIG. 5 is a left side elevation view thereof;  
FIG. 6 is a front elevation view thereof;  
FIG. 7 is a rear elevation view thereof;  
FIG. 8 is a right side elevational view of a second embodiment thereof, the only difference from the first residing in the appearance of the side elevations; and,  
FIG. 9 is a right side elevational view of a third embodiment thereof, the only difference from the first residing in the appearance of the side elevations.

[56] **References Cited**

**U.S. PATENT DOCUMENTS**

D. 262,652 1/1982 Jaeschke et al. .  
D. 286,020 10/1986 Barrash .  
D. 289,011 3/1987 Rusnock et al. .  
D. 290,790 7/1987 Nathan et al. .... D6/515 X  
D. 326,225 5/1992 Beckerman et al. .  
D. 337,048 7/1993 Detert et al. .  
D. 342,420 12/1993 Ienna ..... D6/515 X  
D. 354,181 1/1995 Smith et al. .... D6/515 X  
2,382,191 8/1945 Weichselbaum .  
2,996,344 8/1961 Garman .

**1 Claim, 4 Drawing Sheets**

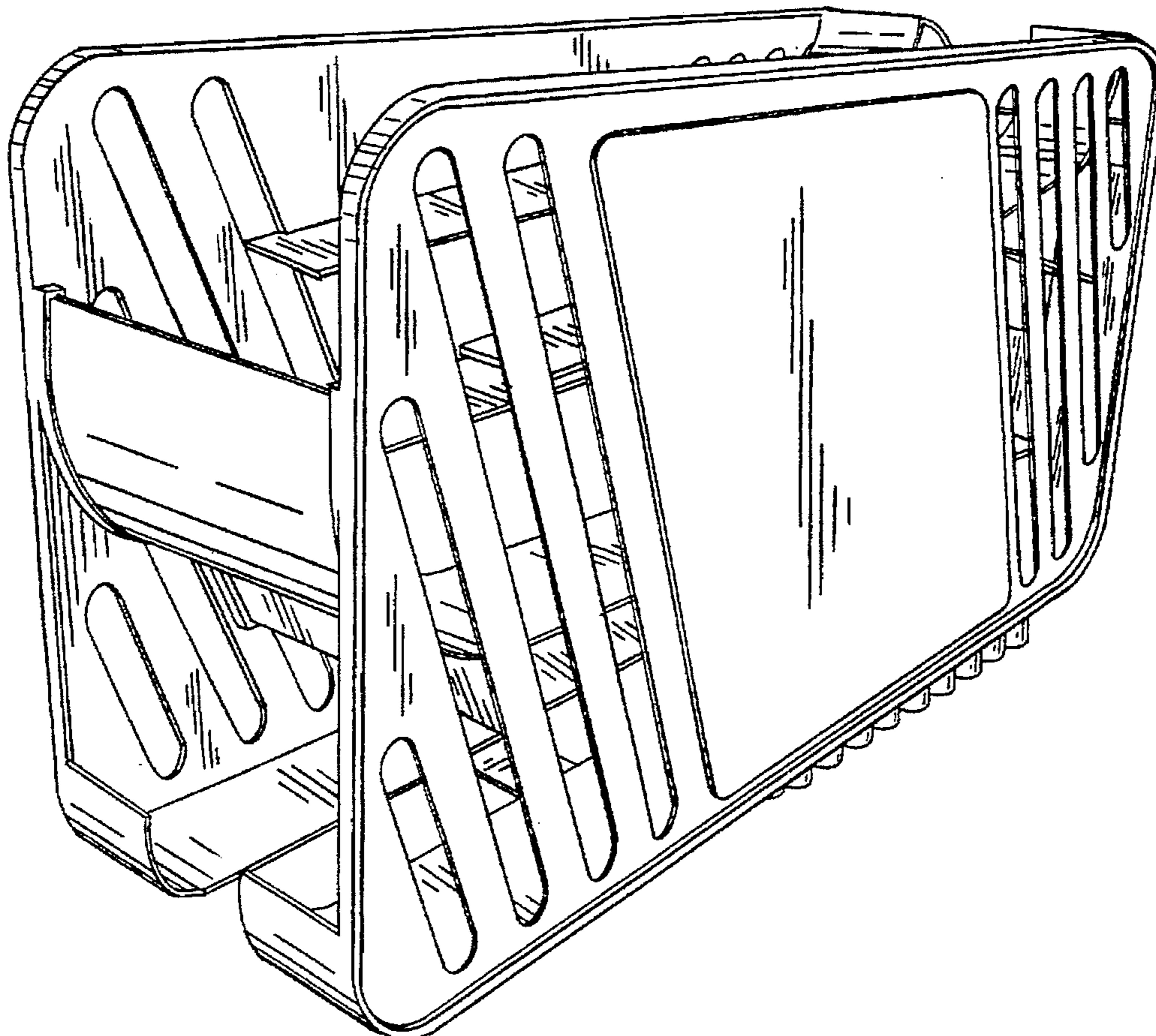

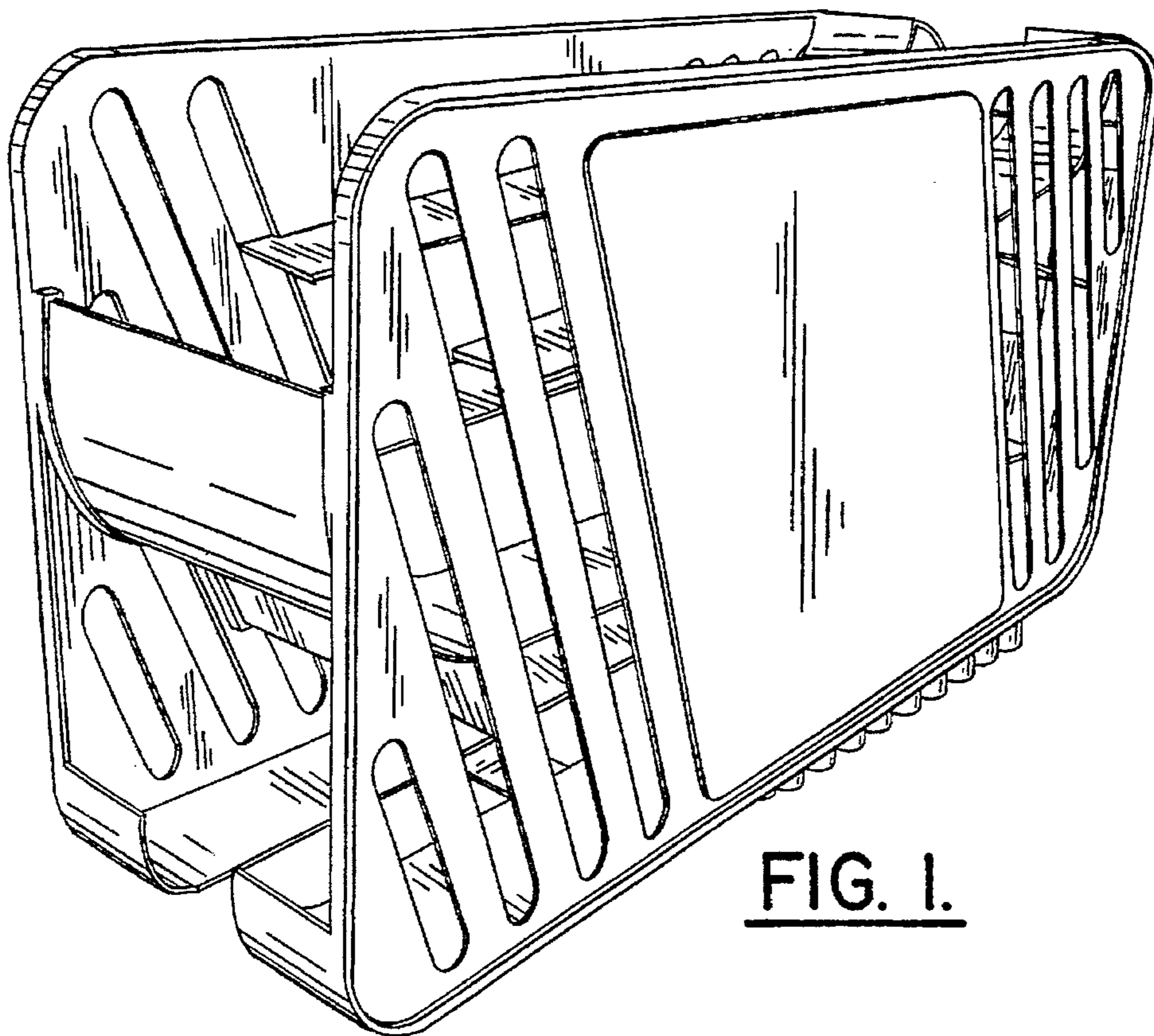

FIG. 1.

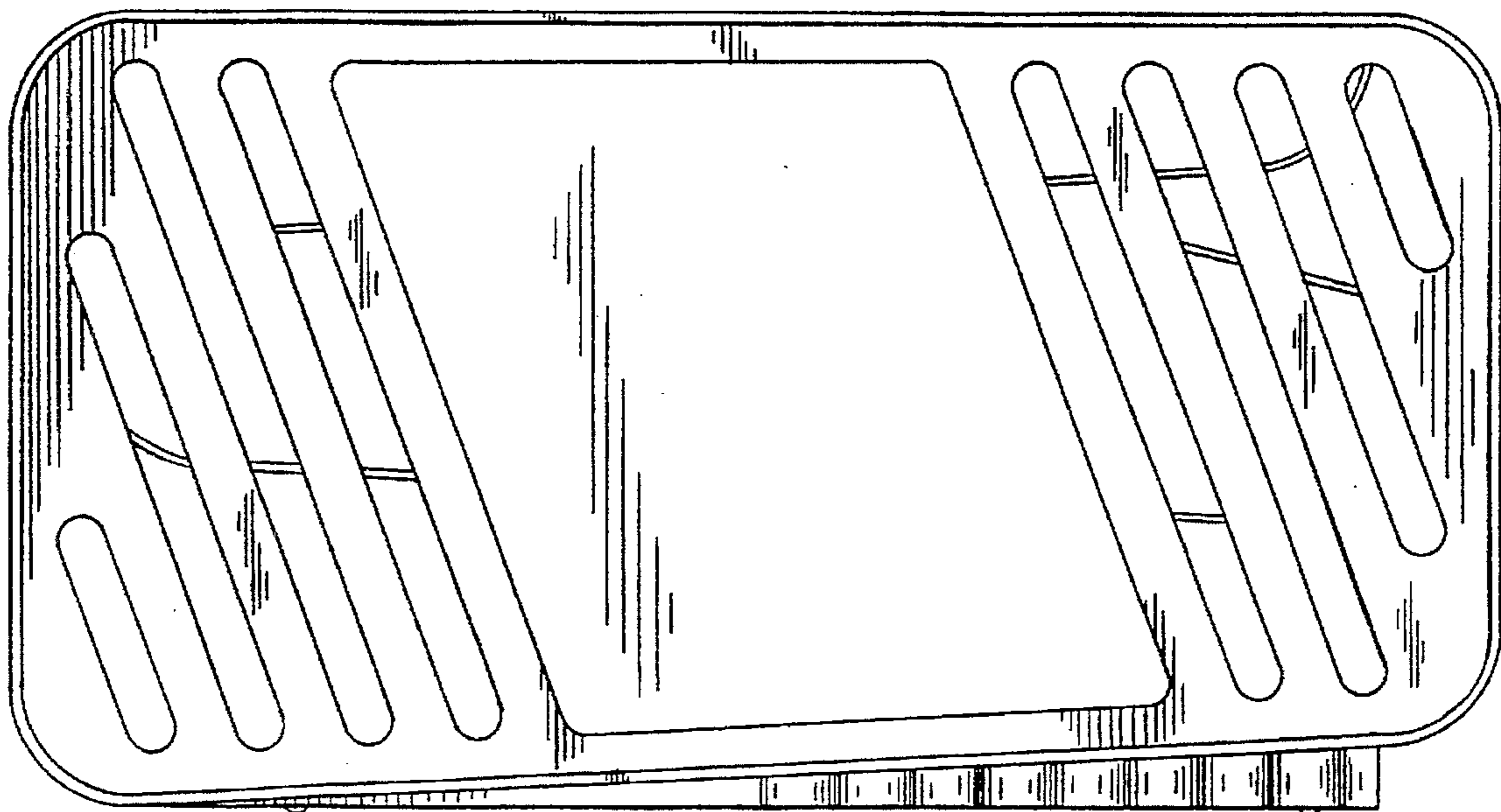

FIG. 2.

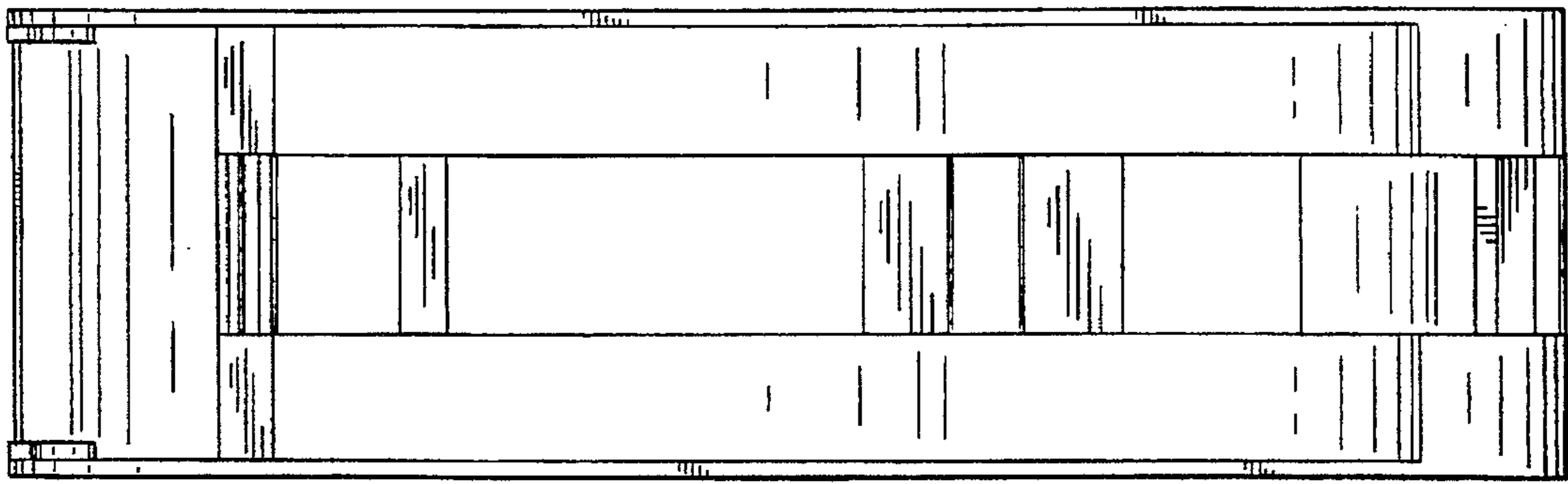

FIG. 3.

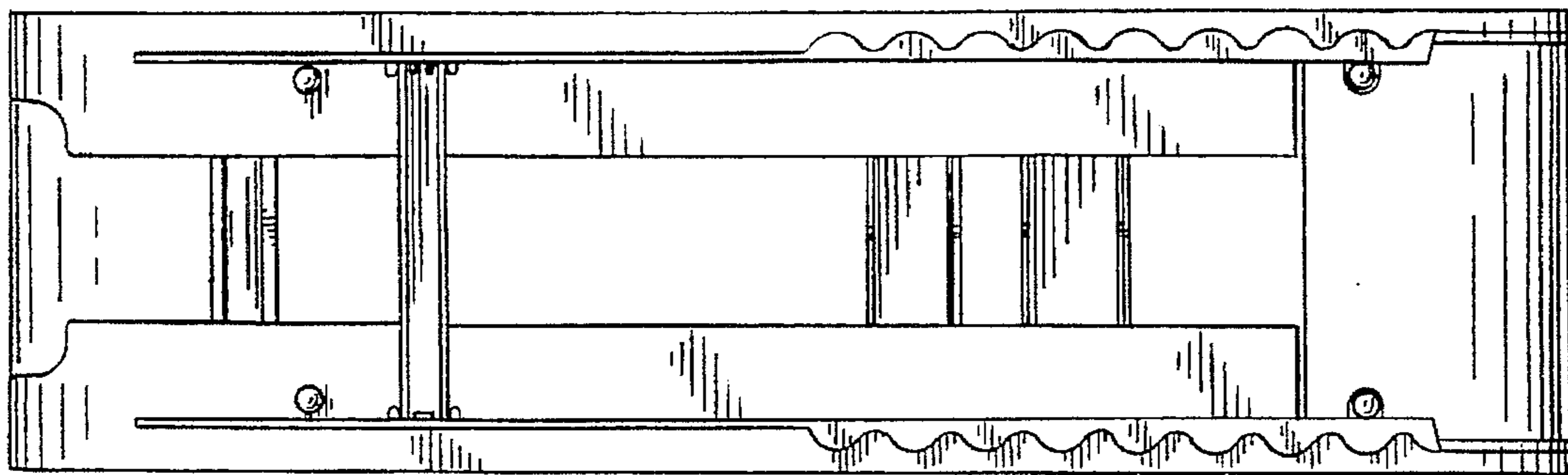

FIG. 4.

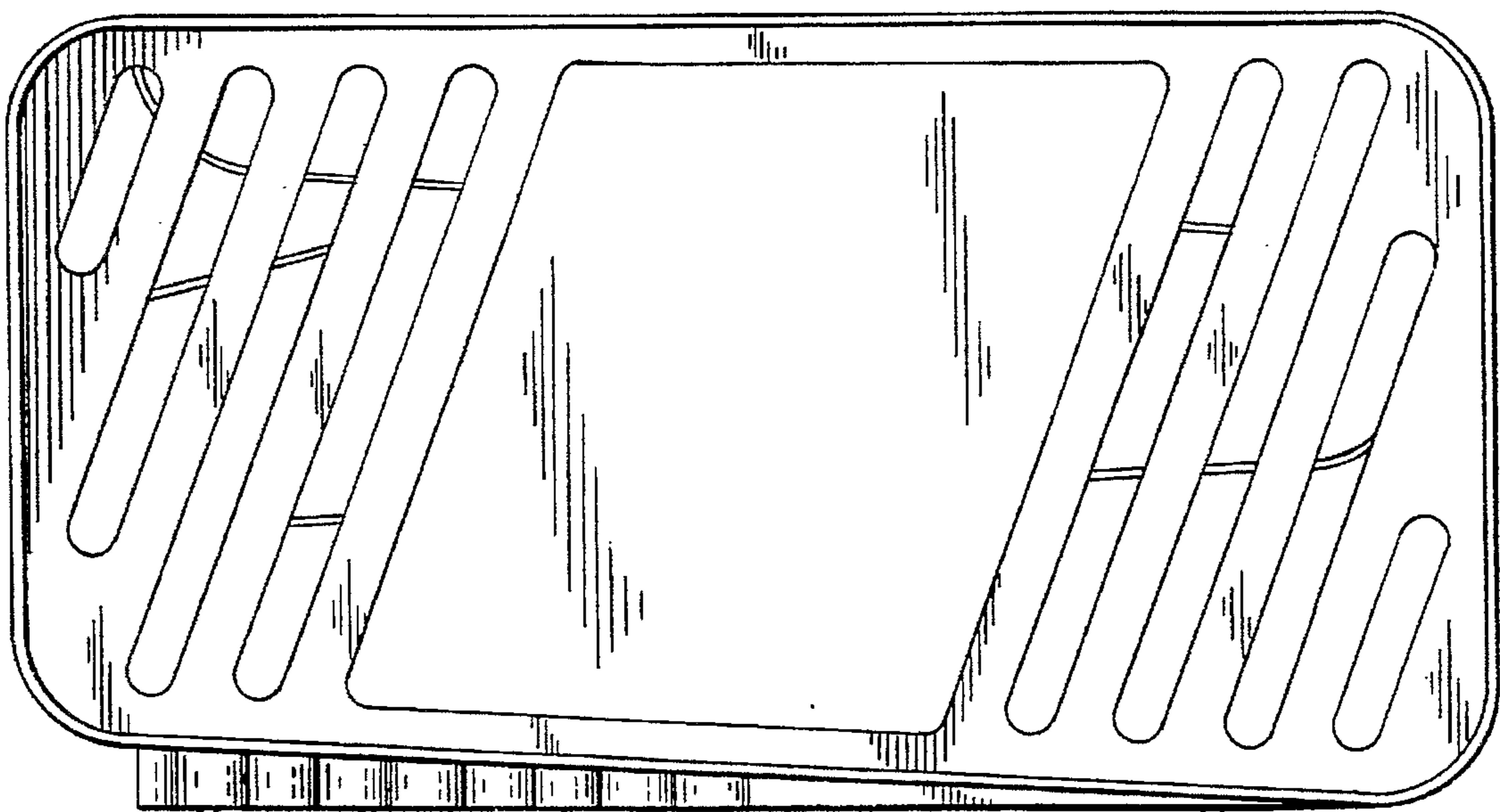

FIG. 5.

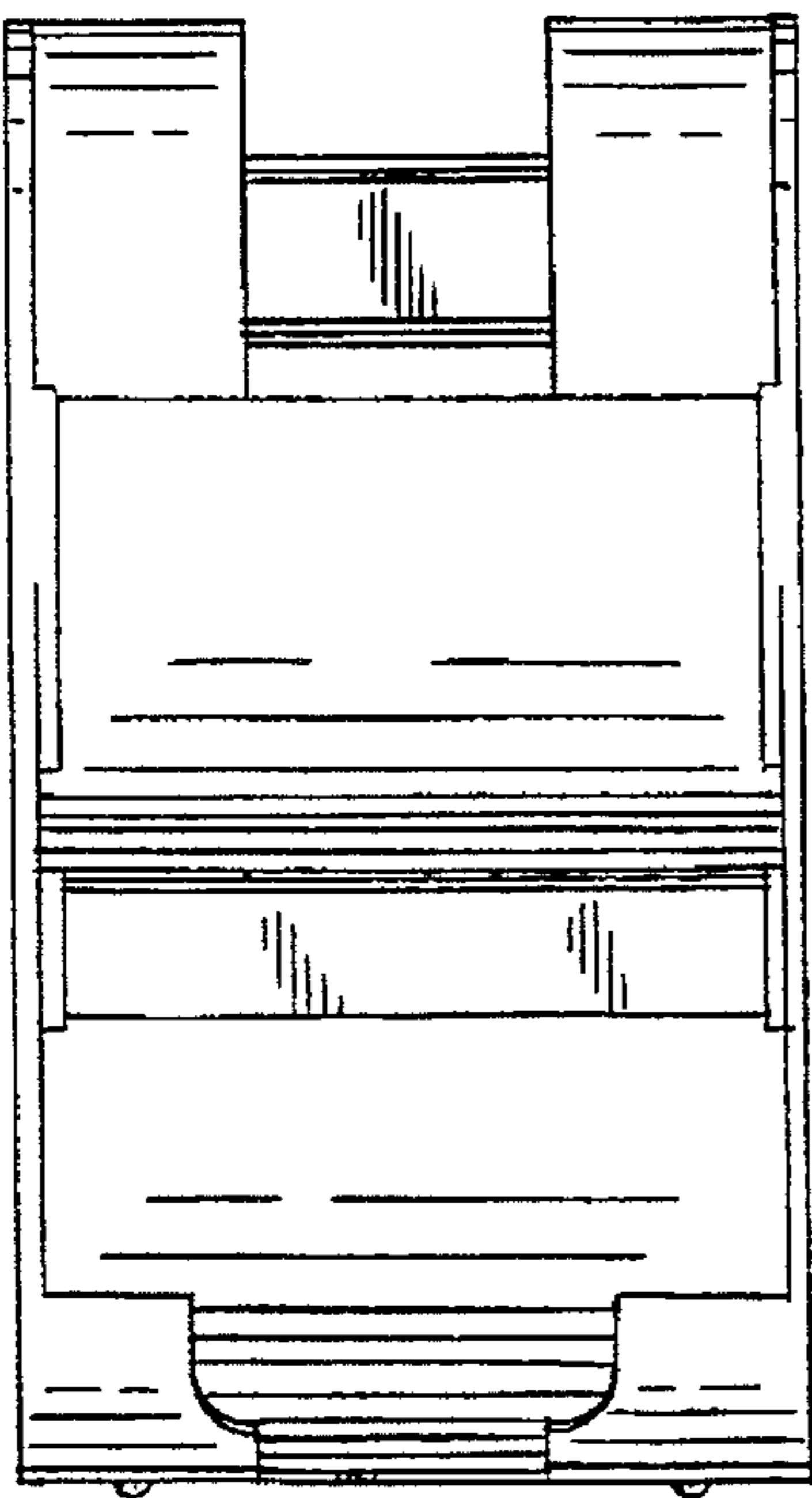

FIG. 6.

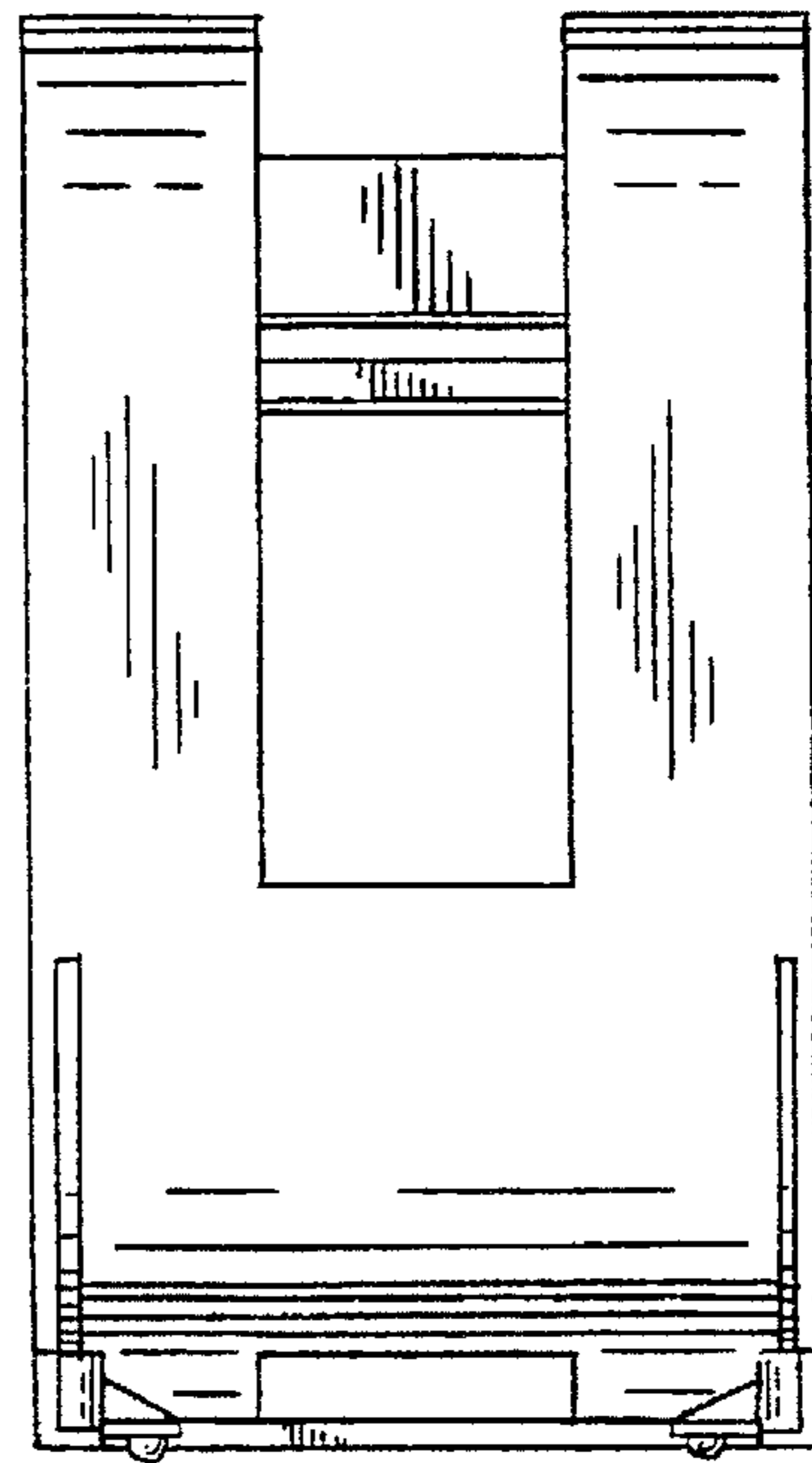

FIG. 7.

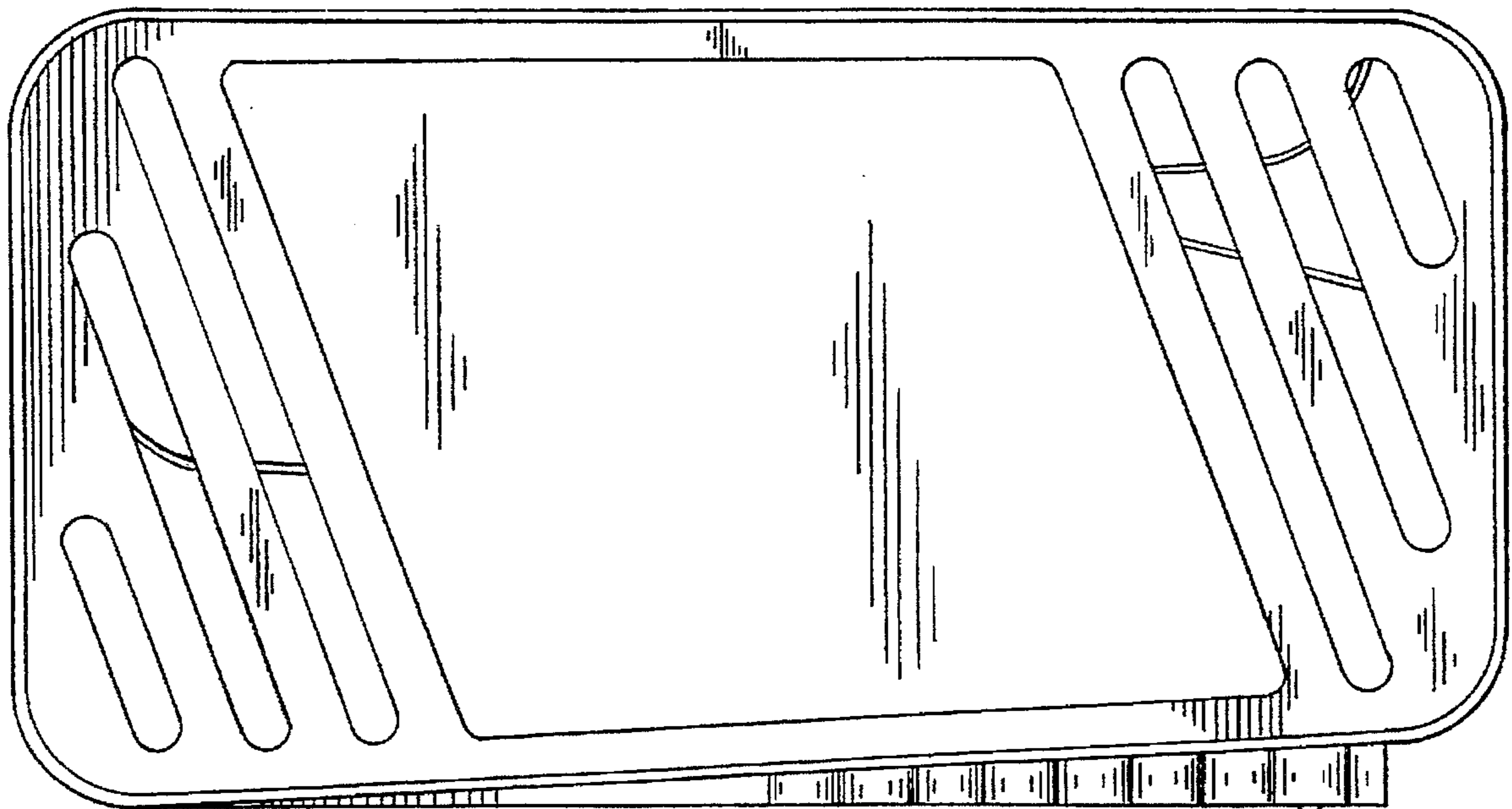

FIG. 8.

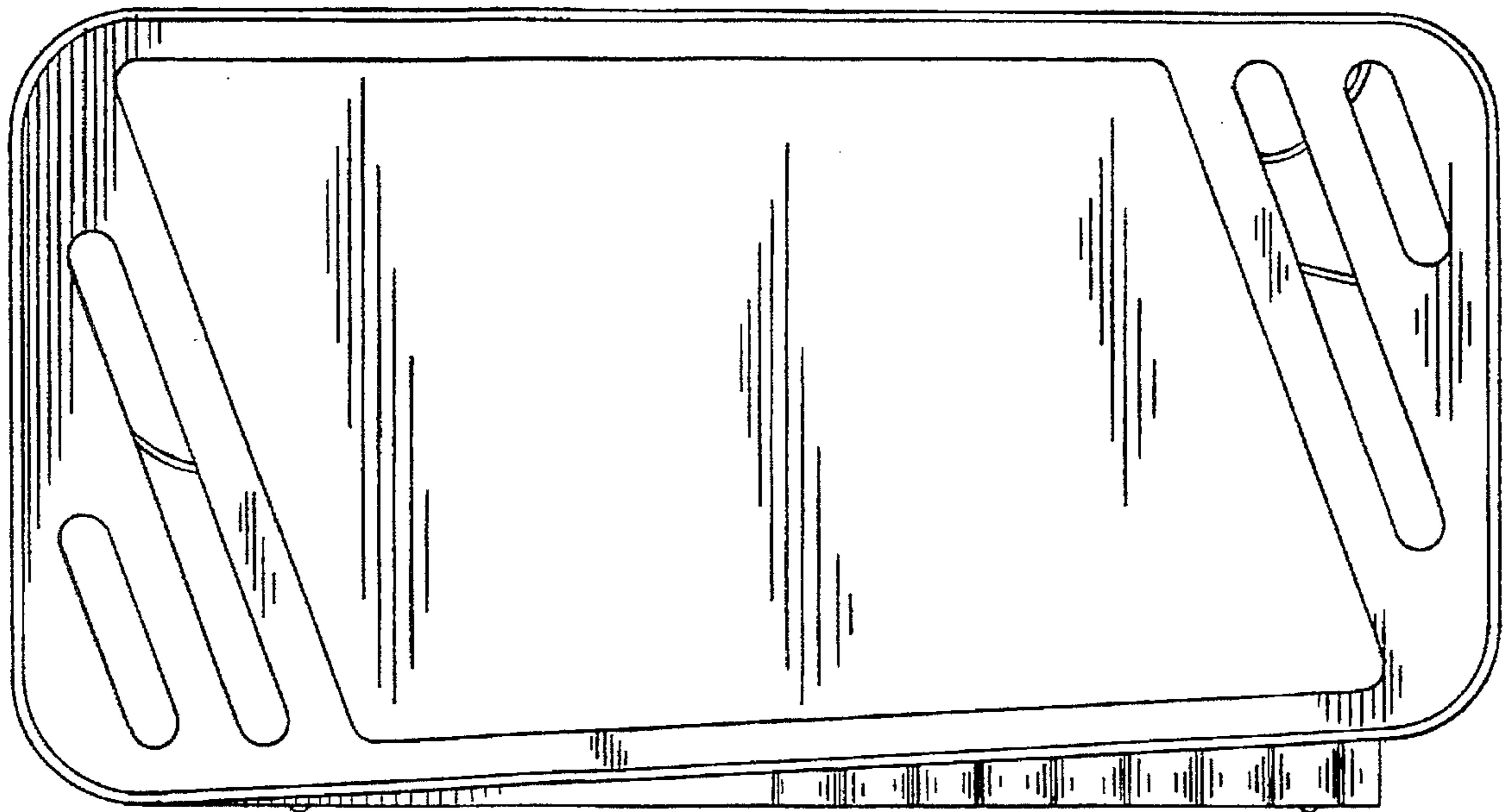

FIG. 9.