



US00D380111S

United States Patent [19]

Brunner et al.

[11] Patent Number: **Des. 380,111**

[45] Date of Patent: ****Jun. 24, 1997**

[54] **ENDBOARD FOR A CRIB OR BED**

[75] Inventors: **Merlin A. Brunner**, Appleton; **Harvey J. Draheim**, Weyauwega, both of Wis.

[73] Assignee: **Simmons Juvenile Products Company, Inc.**, New London, Wis.

[**] Term: **14 Years**

[21] Appl. No.: **54,619**

[22] Filed: **May 17, 1996**

[51] LOC (6) Cl. **06-06**

[52] U.S. Cl. **D6/508**

[58] Field of Search D6/382-385, 390-395, D6/505-508; 5/93.1, 93.2, 96, 99.1, 101

[56] **References Cited**

U.S. PATENT DOCUMENTS

D. 359,183 6/1995 Brunner et al. D6/508

OTHER PUBLICATIONS

Simmons Little Folks, published Feb. 1993, Valentia crib.

Primary Examiner—Janice E. Seeger

Attorney, Agent, or Firm—Hoffmann & Baron

[57] **CLAIM**

The ornamental design for an endboard for a crib or bed, as shown and described.

DESCRIPTION

FIG. 1 is a top perspective view of an endboard for a crib or bed showing our new design;
FIG. 2 is a top plan view thereof;
FIG. 3 is a front elevation view thereof;
FIG. 4 is a side elevation view thereof, the opposite side being a mirror image thereof;
FIG. 5 is a rear elevation view thereof;
FIG. 6 is a bottom plan view thereof;
FIG. 7 is a sectional view taken along line 7—7 of FIG. 3;
FIG. 8 is a sectional view taken along line 8—8 of FIG. 3;
FIG. 9 is a top perspective view of an endboard for a crib or bed showing an alternative embodiment of our new design;
FIG. 10 is a top plan view thereof;
FIG. 11 is a front elevation view thereof;
FIG. 12 is a side elevation view thereof, the opposite side being a mirror image thereof;
FIG. 13 is a rear elevation view thereof;
FIG. 14 is a bottom plan view thereof;
FIG. 15 is a sectional view taken along line 15—15 of FIG. 11; and,
FIG. 16 is a sectional view taken along line 16—16 of FIG. 11.

1 Claim, 10 Drawing Sheets

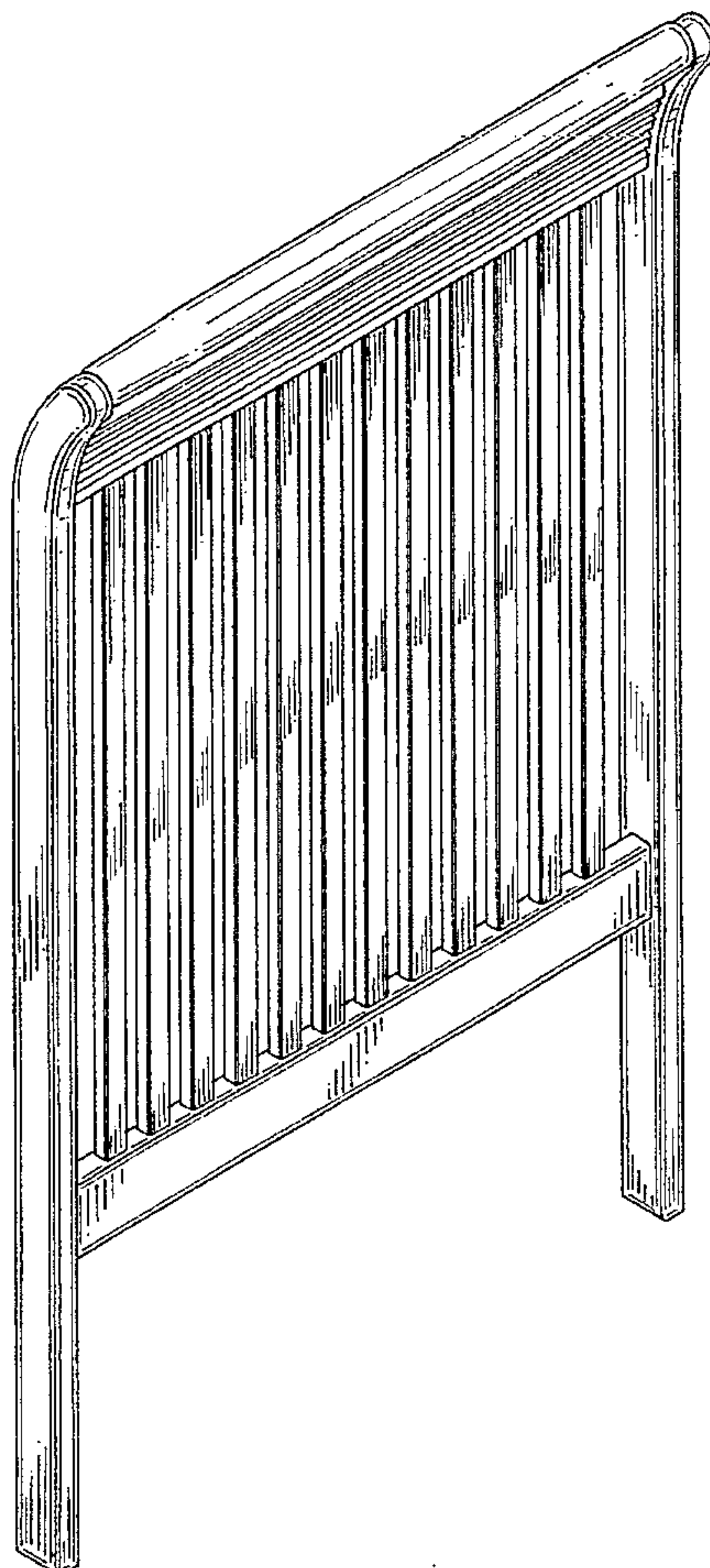

FIG-1

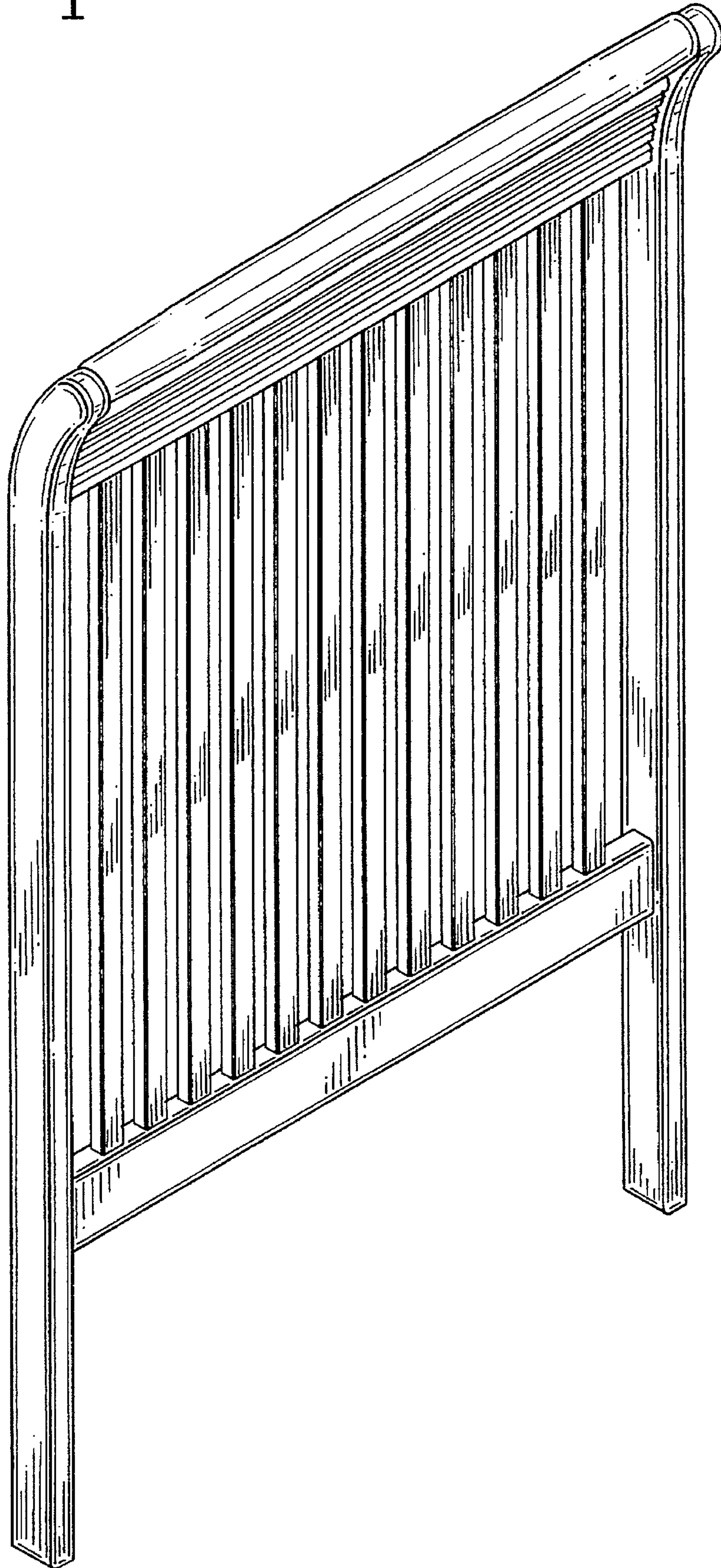

FIG-2

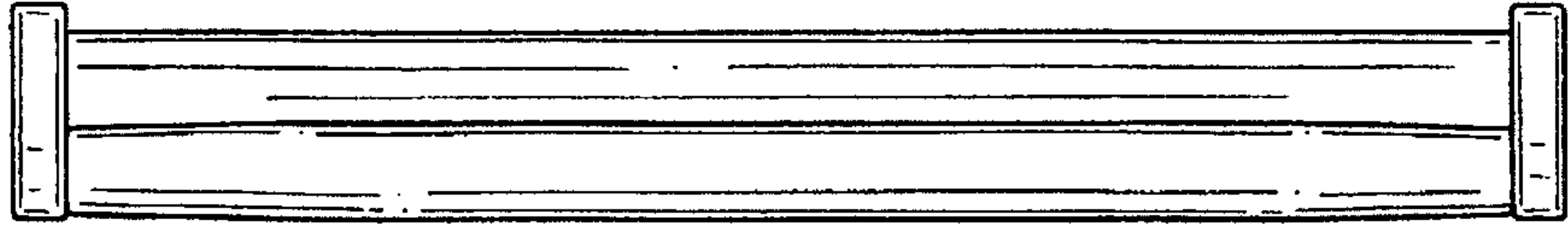

FIG-3

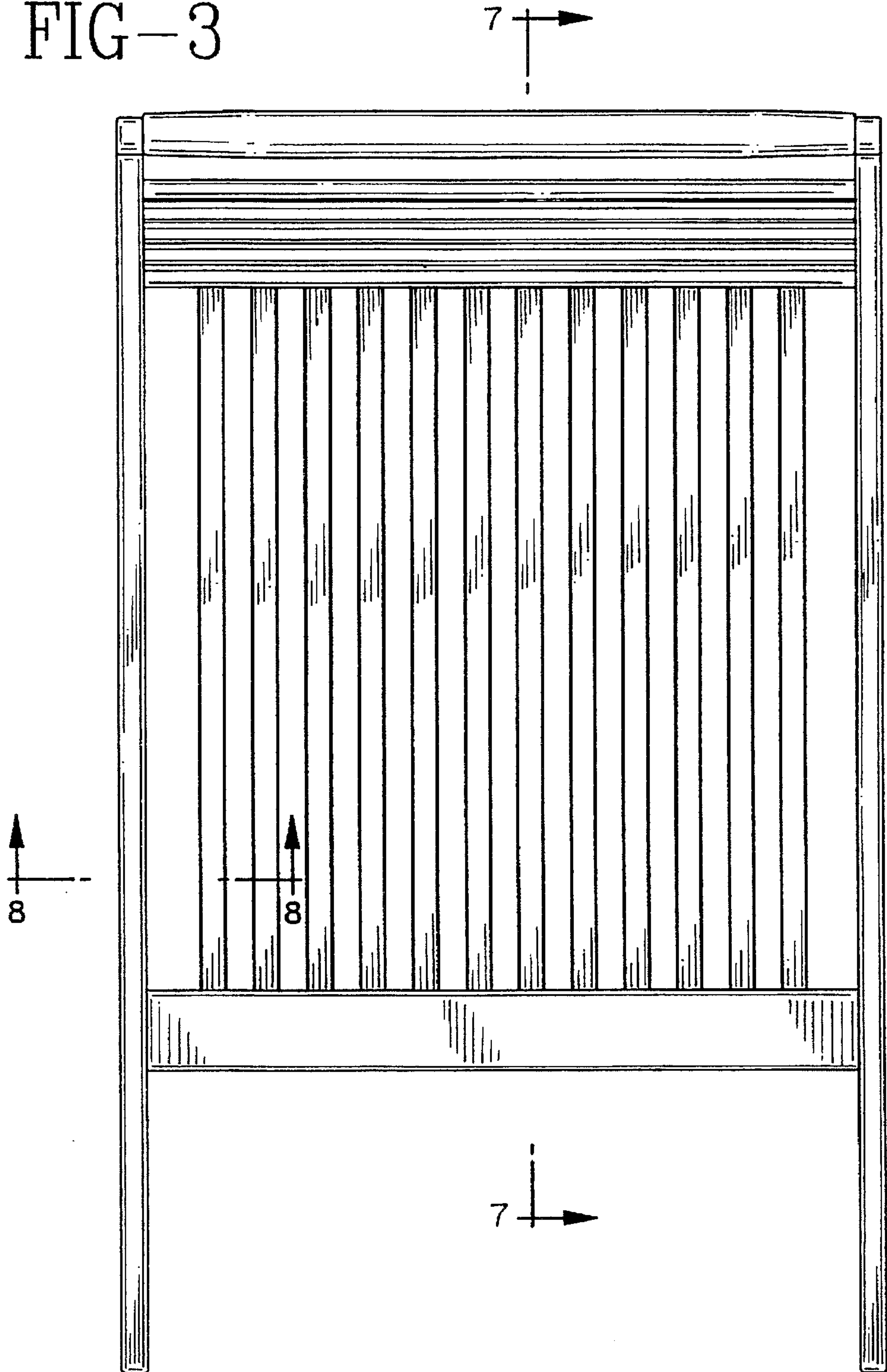

FIG-4



FIG-5

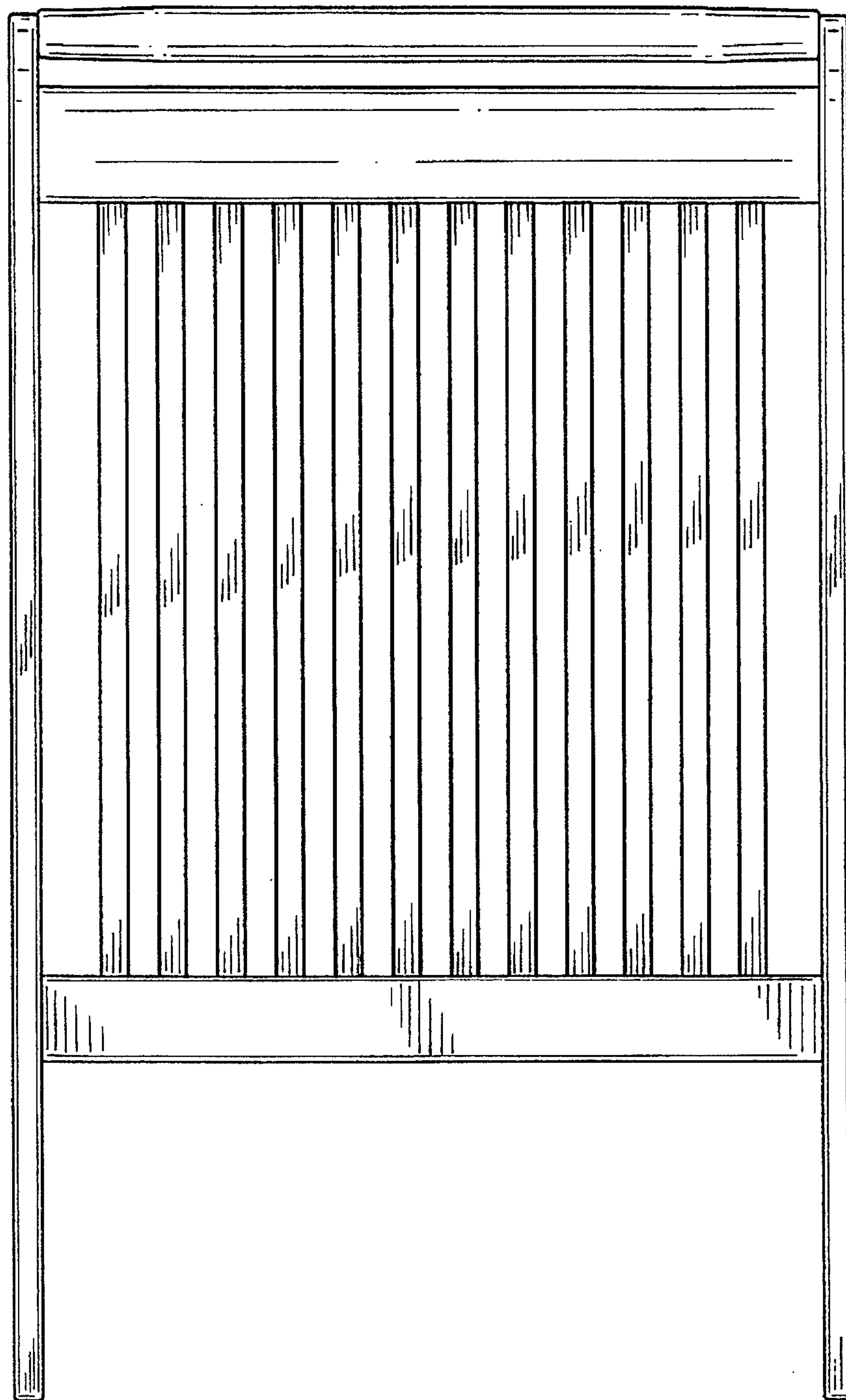

FIG-6

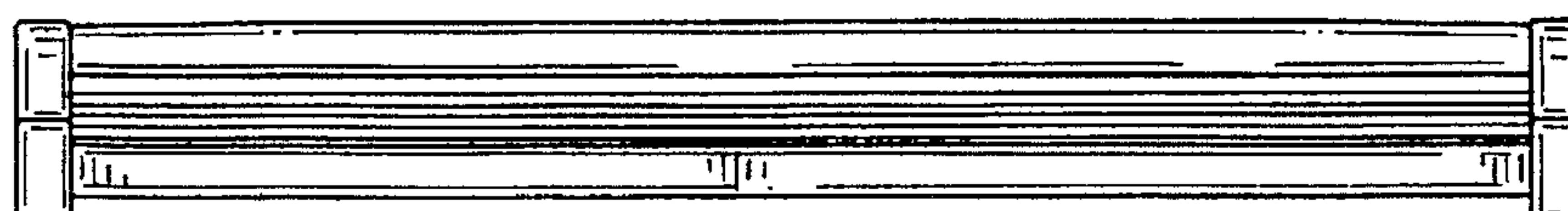

FIG-7

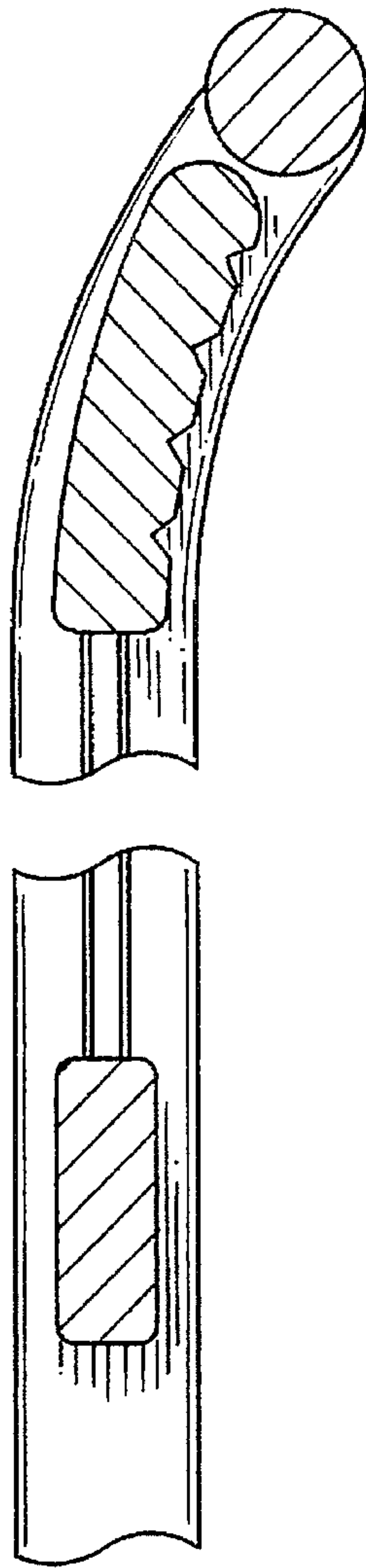

FIG-8

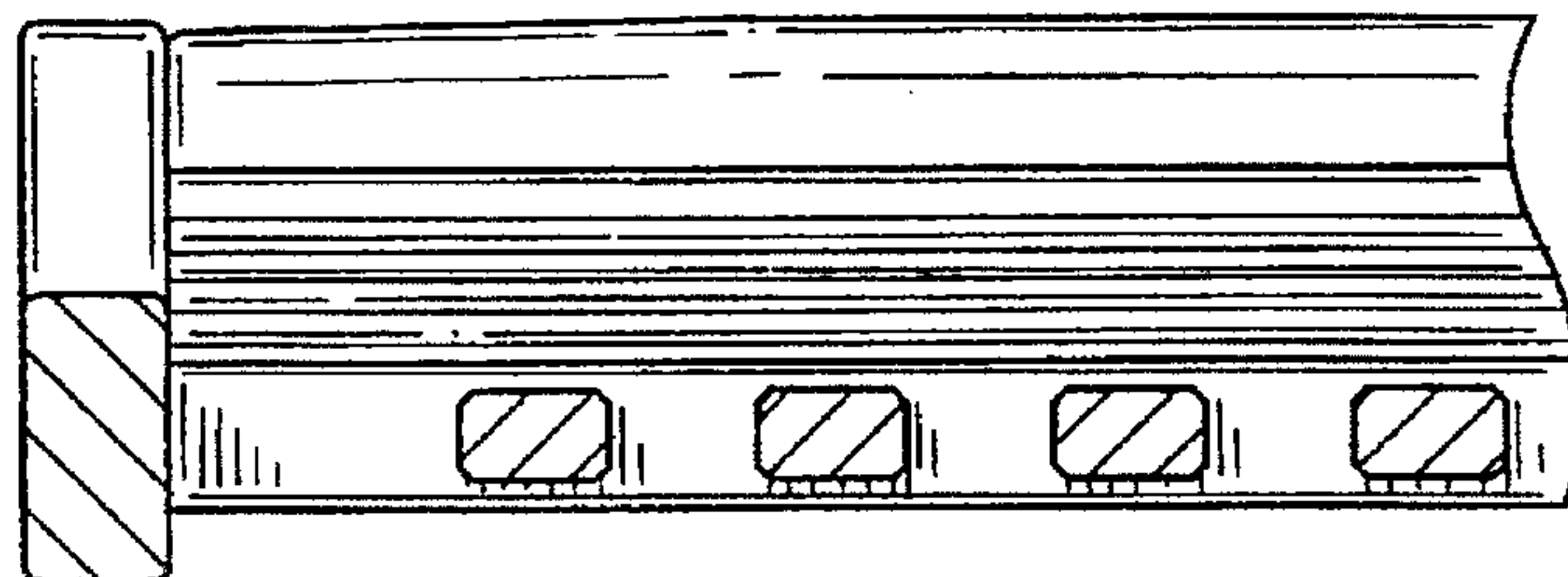

FIG-9

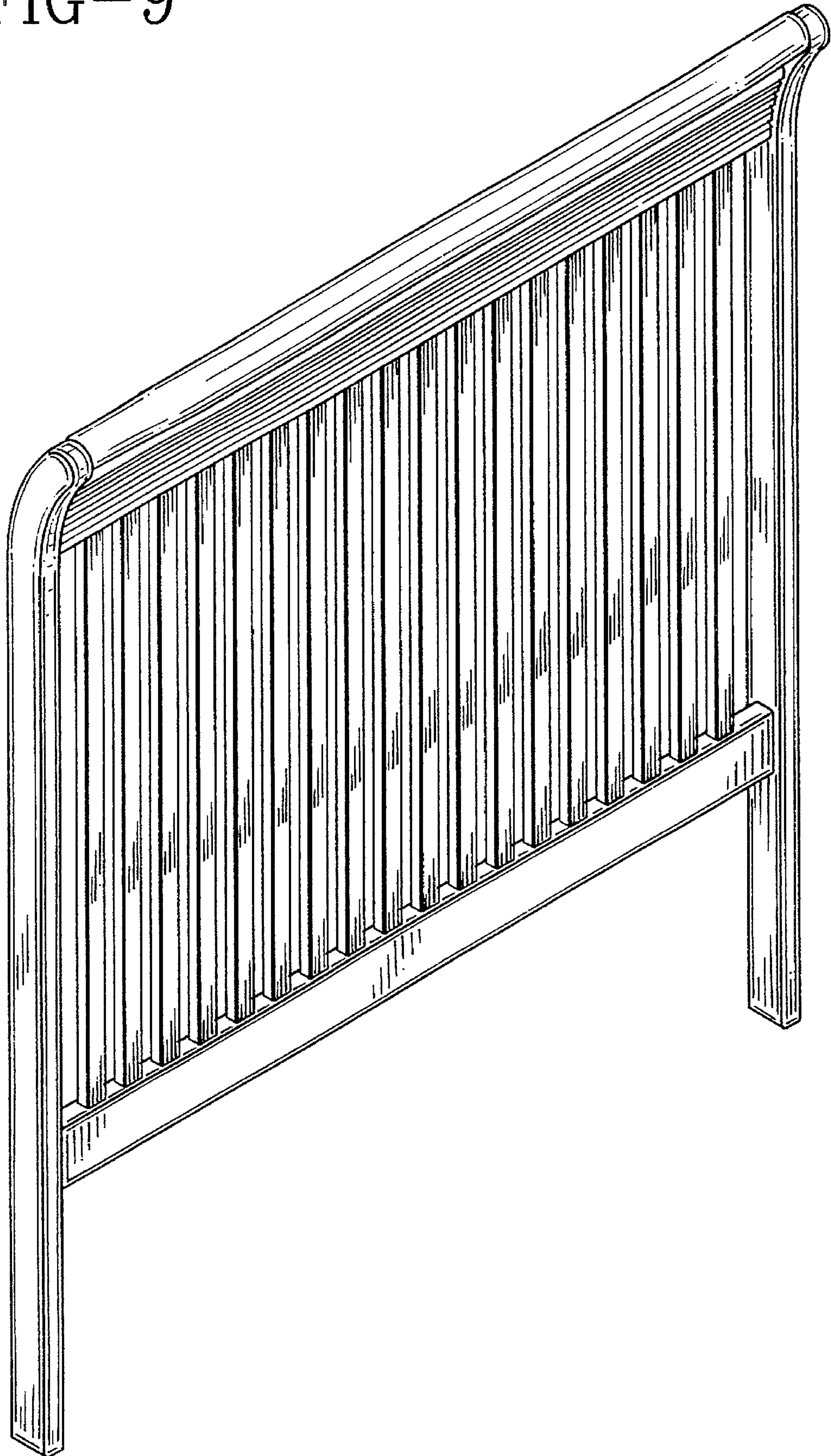

FIG-10

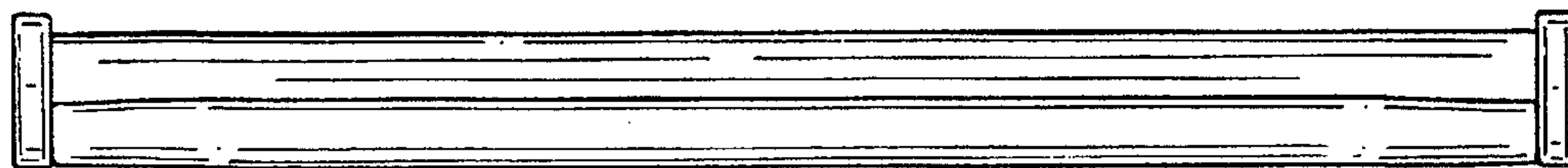

FIG-11

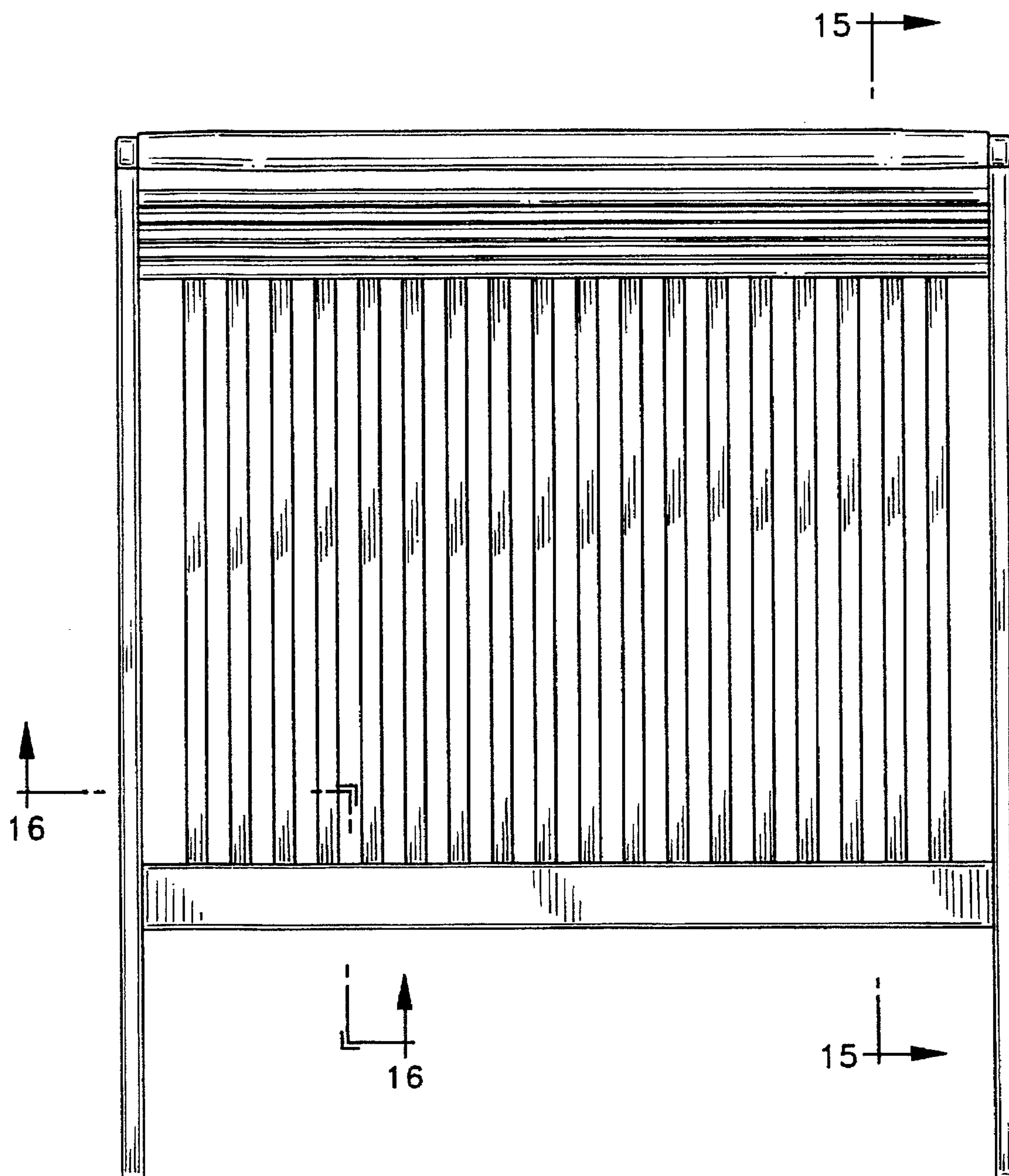

FIG-12

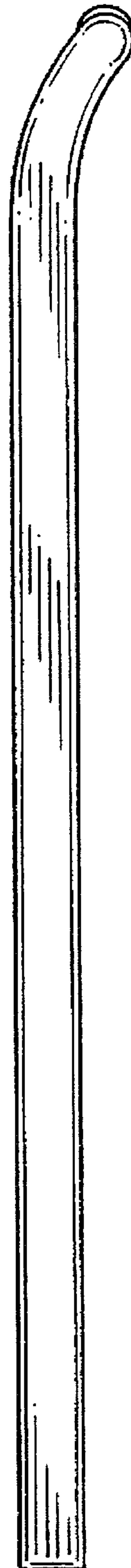

FIG-13

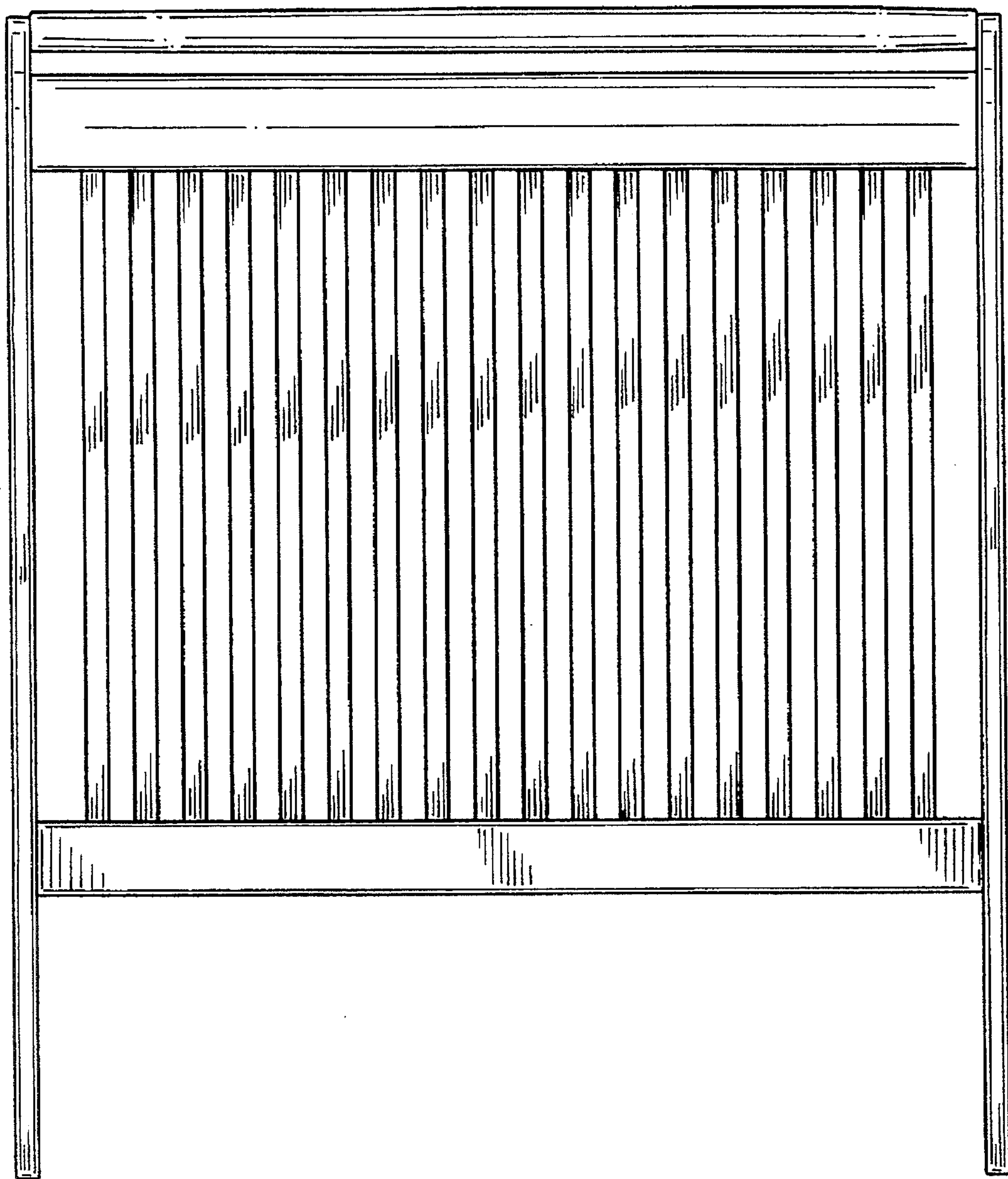

FIG-14

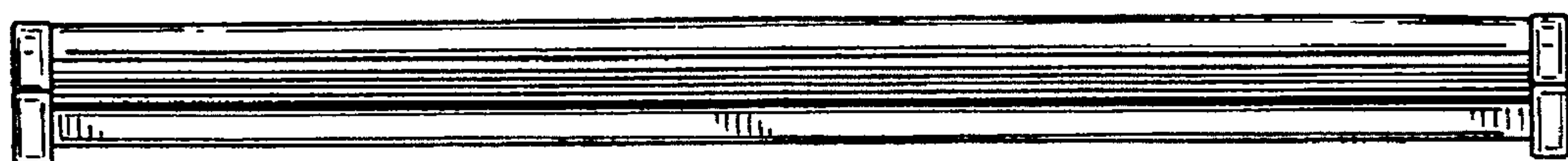

FIG-15

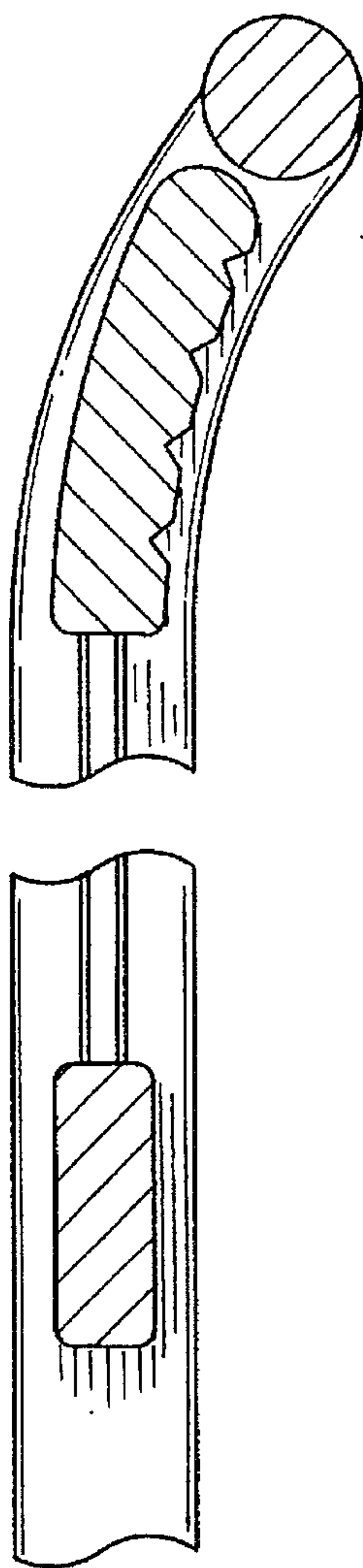

FIG-16

