



US00D380105S

United States Patent [19]

[11] Patent Number: **Des. 380,105**

Diaz-Azcuy

[45] Date of Patent: ****Jun. 24, 1997**

[54] SEAT

[75] Inventor: **Orlando Diaz-Azcuy**, San Francisco, Calif.

[73] Assignee: **McGuire Furniture Company Inc.**, San Francisco, Calif.

[**] Term: **14 Years**

[21] Appl. No.: **51,424**

[22] Filed: **Mar. 11, 1996**

[51] LOC (6) Cl. **06-01**

[52] U.S. Cl. **D6/381; D6/369; D6/379**

[58] Field of Search D6/334, 335, 369, D6/370, 374, 376, 379, 380, 381, 500, 501, 502; 297/232, 445.1, 446.1

[56] References Cited

U.S. PATENT DOCUMENTS

- D. 198,450 6/1964 Slosberg D6/369
- D. 255,295 6/1980 Thorpe D6/369
- D. 357,366 4/1995 McGuire .

OTHER PUBLICATIONS

Saladino Furniture Brochure, Trellis Sofa shown. LFI/Landscape Forms, p. 4, Trellis Bench at center right. *Furniture of the Ancient World* by Hoelis S. Baker, p. 179, picture 285 (bottom left hand corner). undated. *Furniture of the Ancient World* by Hoelis S. Baker, p. 227, picture 366. undated. *The Antiques Directory of Furniture*, (Judith & Martin Miller, eds. 1985), picture Nos. 1087, 1088.

The Antiques Directory of Furniture, (Judith & Martin Miller, eds. 1985), p. 105, picture Nos. 320, 321-322.

McGuire Catalog dated 1985, 1987, 1992, p. 14 for Model C-29/SL sofa.

McGuire Catalog dated 1985, 1987, 1992, p. 17 for Model LM-24 chair.

McGuire Catalog dated 1985, 1987, 1992, p. 29 for Models M-151, M-152 chairs.

Primary Examiner—Gary D. Watson
Attorney, Agent, or Firm—Merchant, Gould, Smith, Edell, Welter & Schmidt

[57] CLAIM

The ornamental design for seat, as shown and described.

DESCRIPTION

FIG. 1 is a perspective view taken from the top, front and right side of a seat embodying my new design in the form of a sofa;

FIG. 2 is a front elevational view thereof;

FIG. 3 is a rear elevational view thereof;

FIG. 4 is a top plan view thereof;

FIG. 5 is a bottom plan view thereof;

FIG. 6 is a right side elevational view thereof, the left side elevational view being the mirror image of the right side shown; and,

FIG. 7 is a perspective view taken from the top, front and right side of an alternate embodiment of my invention in the form of a chair wherein the difference is substantially a matter of length.

1 Claim, 6 Drawing Sheets

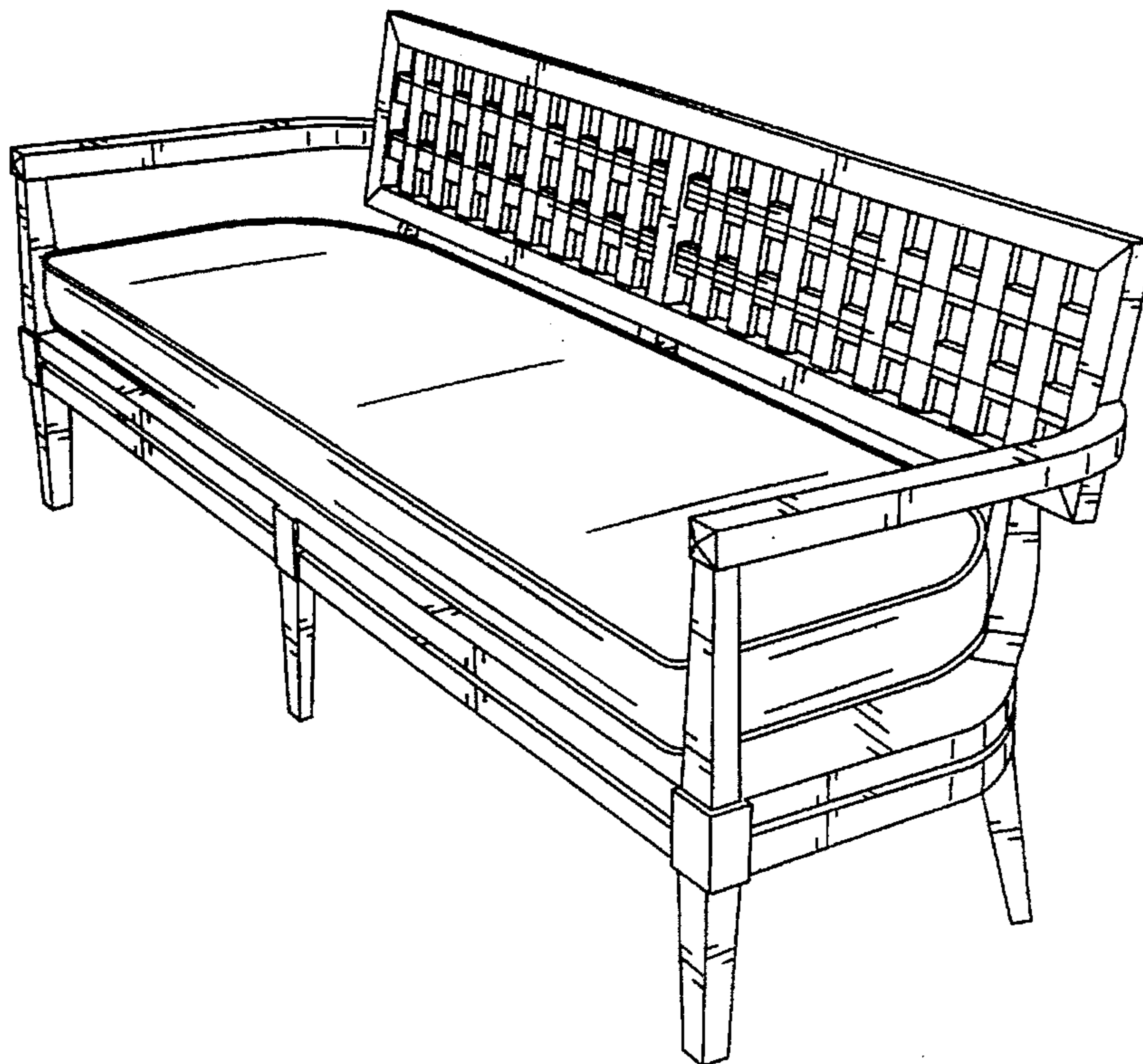

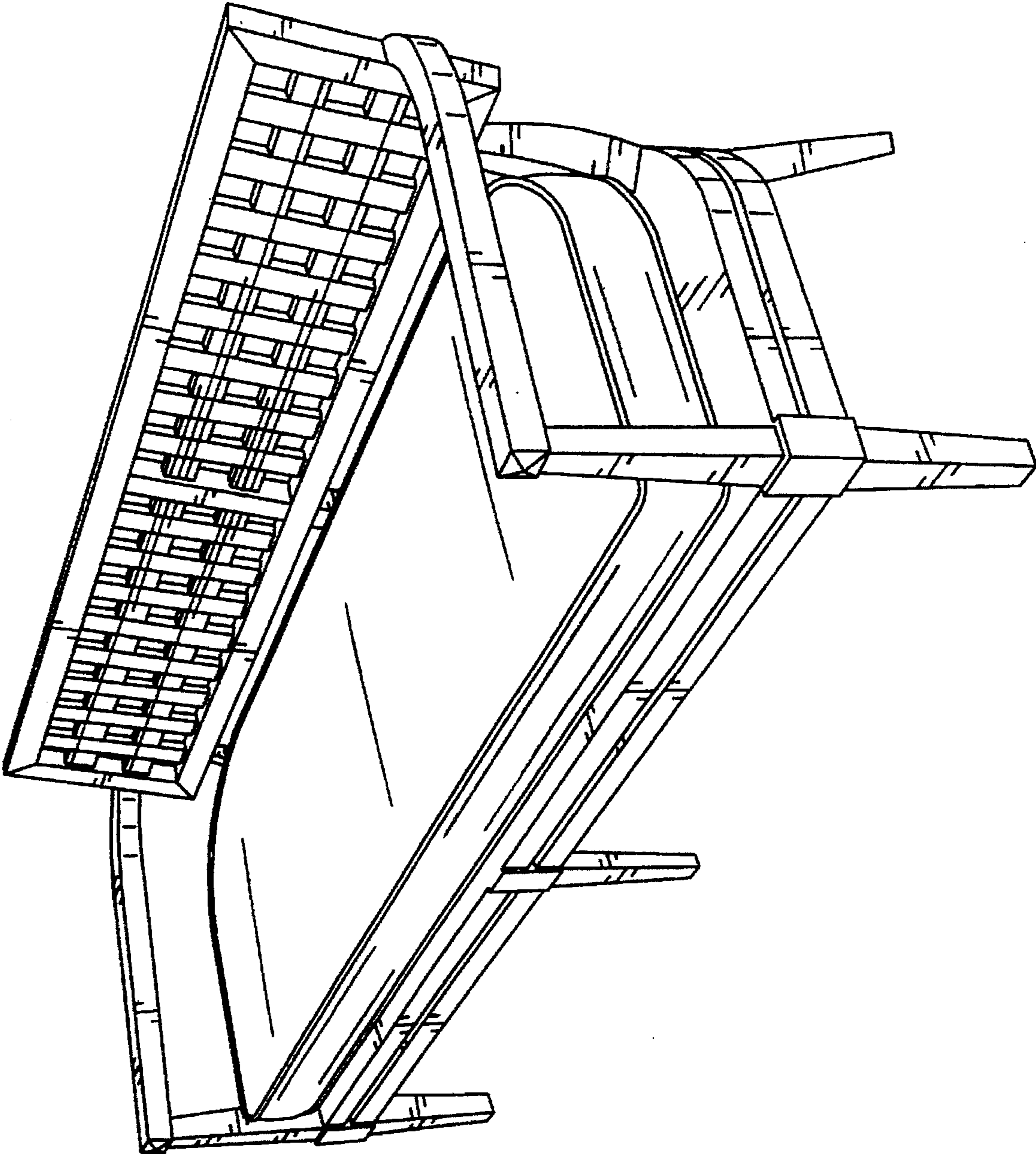

FIG. 1

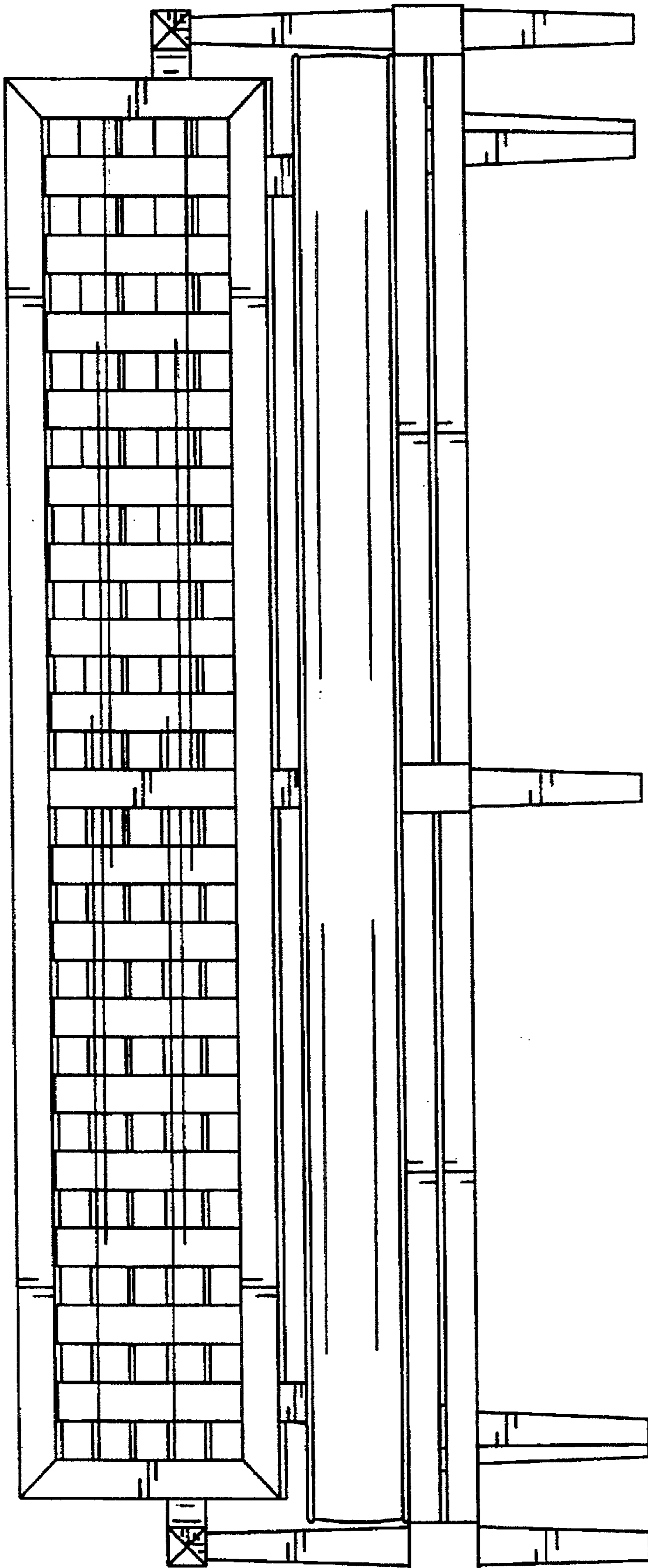

FIG. 2

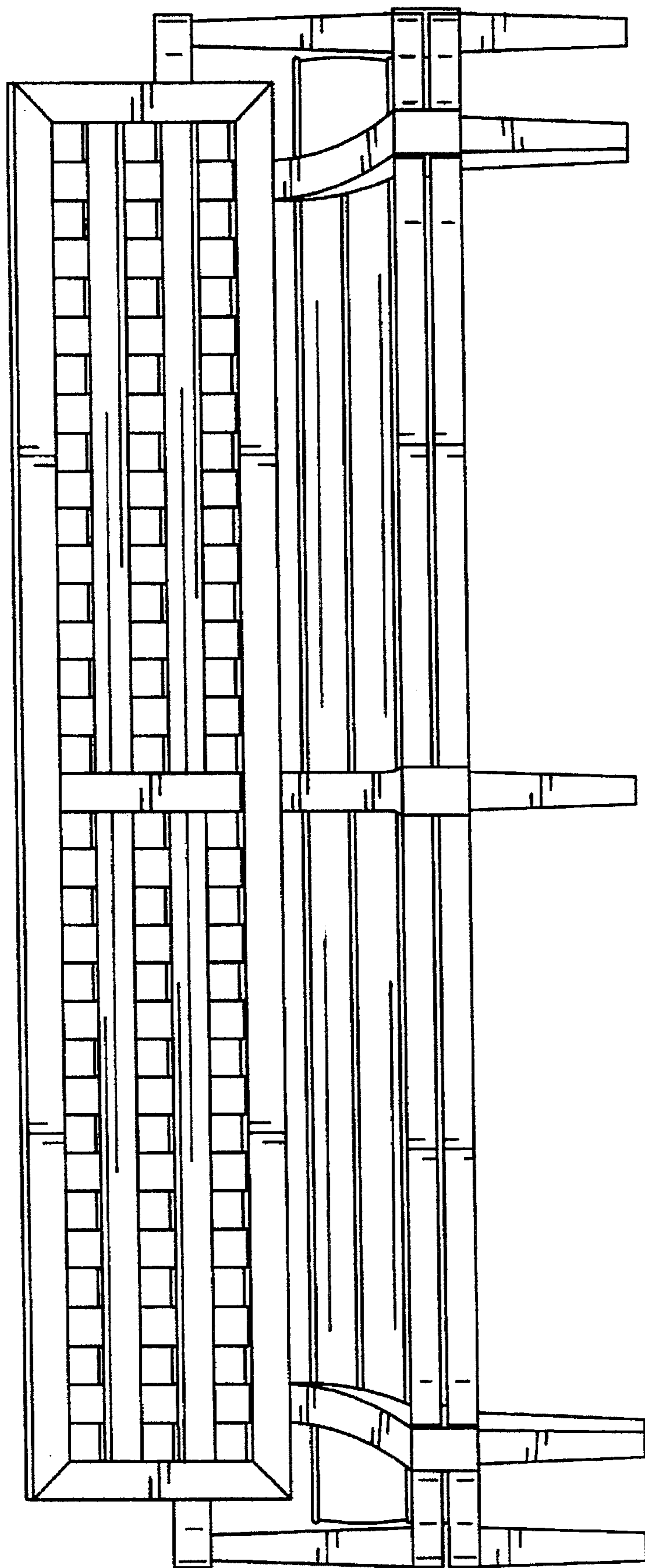

FIG. 3

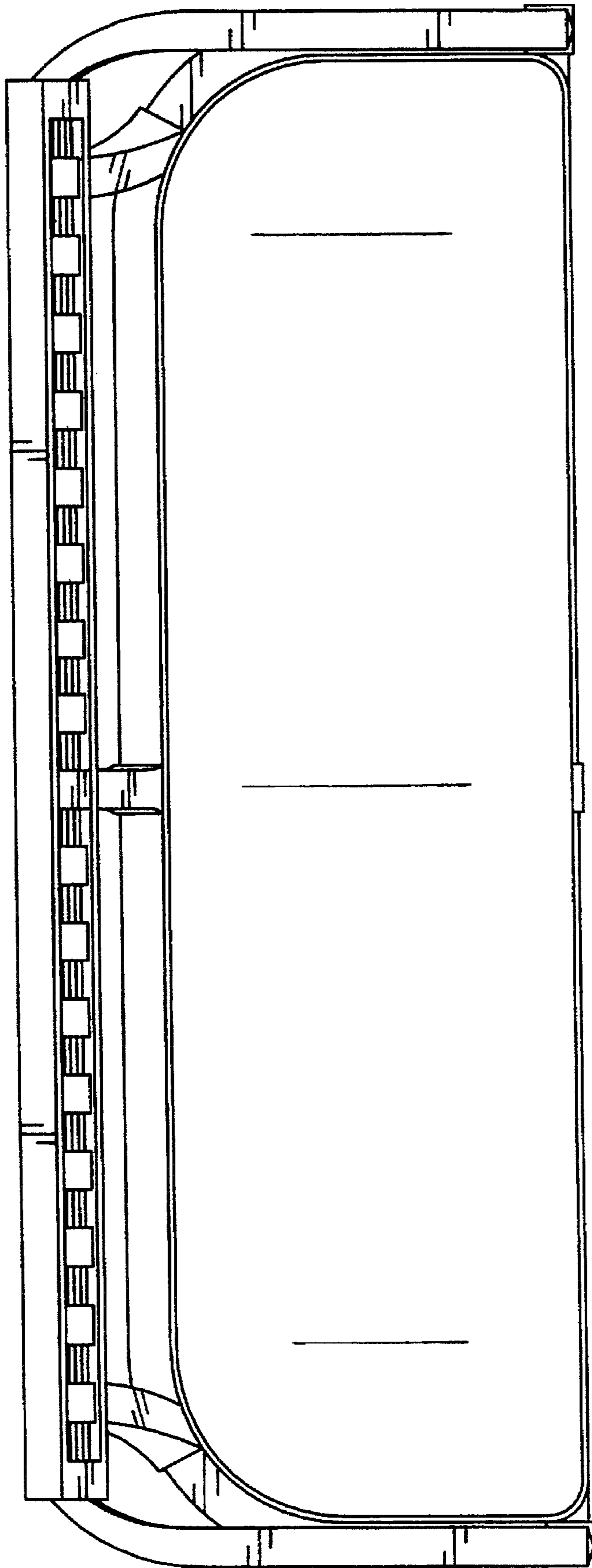

FIG. 4

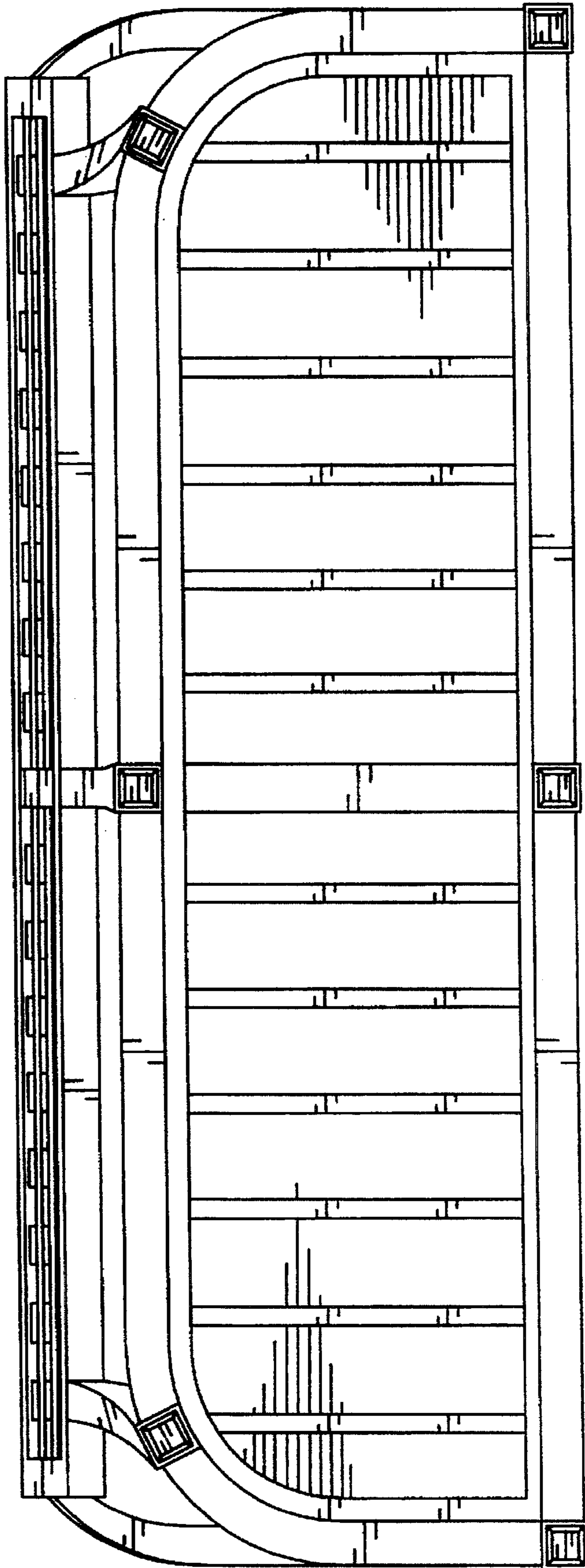

FIG. 5

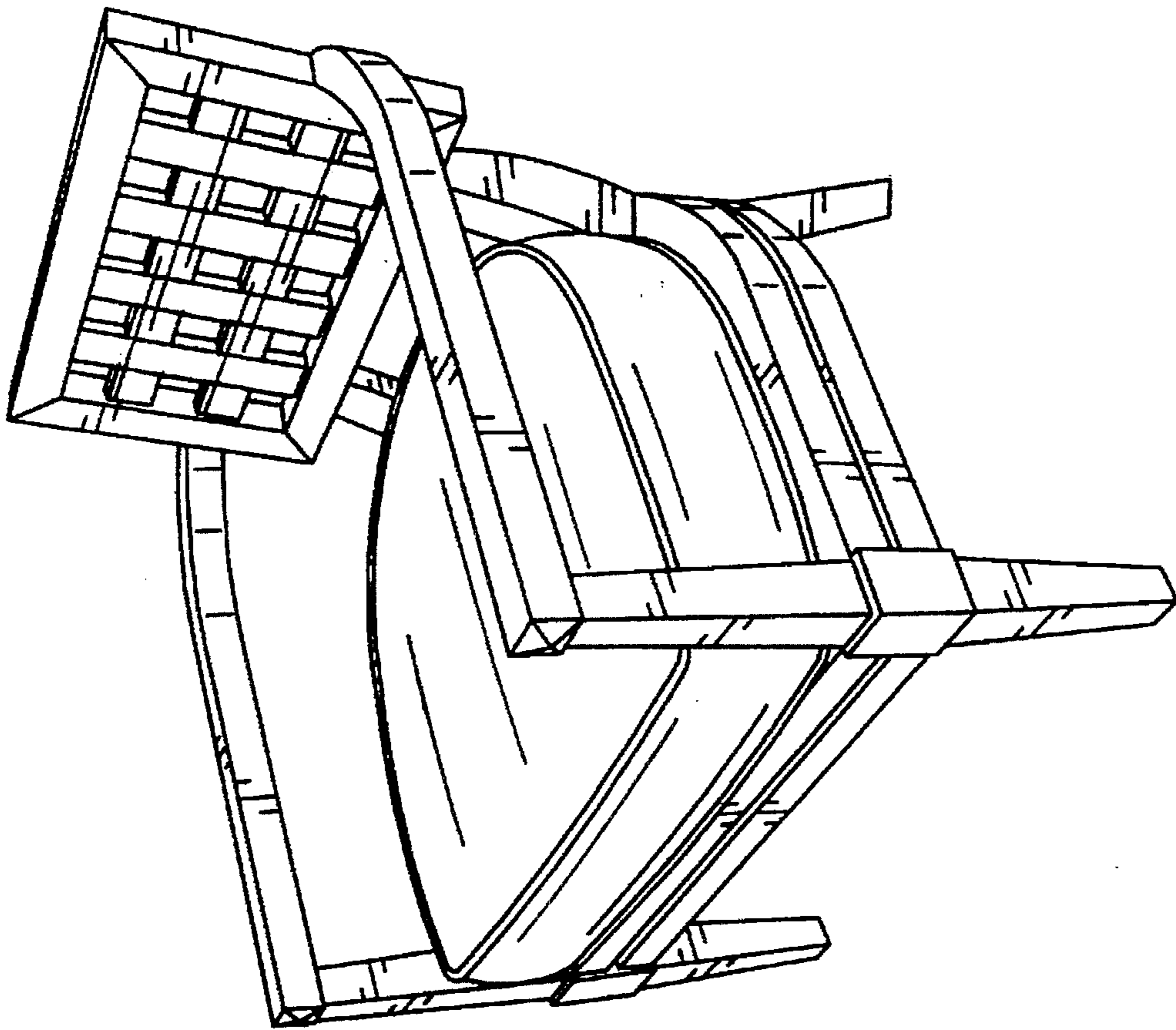

FIG. 7

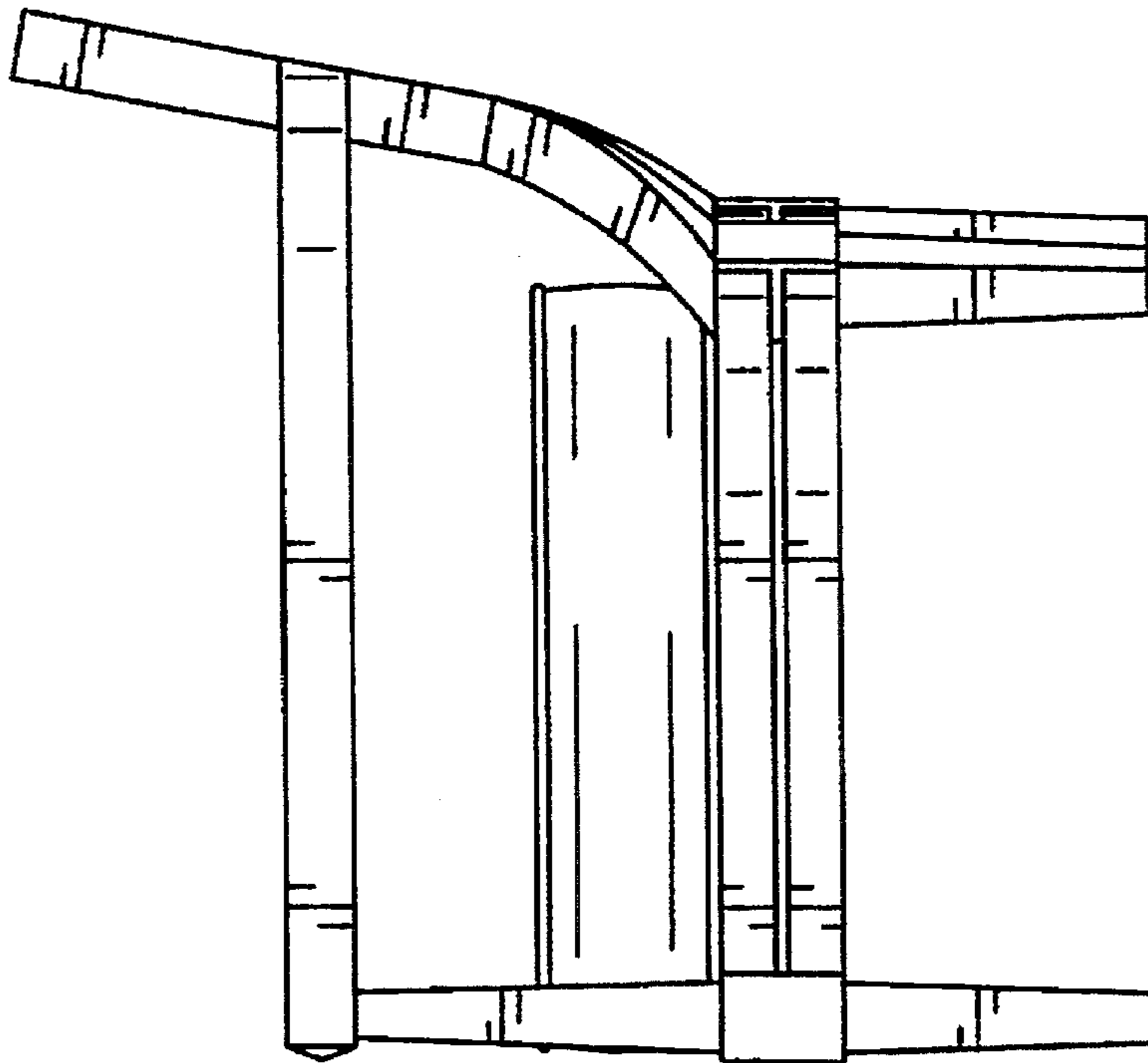

FIG. 6