



US00D380036S

**United States Patent** [19]  
**Short et al.**

[11] **Patent Number: Des. 380,036**  
[45] **Date of Patent: \*\*Jun. 17, 1997**

[54] **FAUCET HANDLE**

[75] Inventors: **Kevin Short, LaGrange; Scott C. Baker, Hoffman Estates; John C. Watson, Westchester, all of Ill.**

[73] Assignee: **The Chicago Faucet Company, Des Plaines, Ill.**

[\*\*] Term: **14 Years**

[21] Appl. No.: **54,066**

[22] Filed: **Apr. 29, 1996**

[51] **LOC (6) Cl. .... 23-01**

[52] **U.S. Cl. .... D23/252**

[58] **Field of Search .... D23/238-243,  
D23/250-255; D8/300, 303, 306, 307, 308;  
16/118, 119, 120, 121, 125**

[56] **References Cited**

**U.S. PATENT DOCUMENTS**

D. 324,901	3/1992	Bonnell	.....	D23/252
D. 326,139	5/1992	Ragonot	.....	D23/252
D. 339,852	9/1993	Jans	.....	D23/252
D. 349,329	8/1994	Robbins	.....	D23/252
D. 354,798	1/1995	Mark	.....	D23/252
D. 366,518	1/1996	Moon	.....	

D. 366,519 1/1996 Lobermeier .

*Primary Examiner*—Doris V. Coles  
*Assistant Examiner*—Eric Watterson  
*Attorney, Agent, or Firm*—Leydig, Voit & Mayer, Ltd.

[57] **CLAIM**

The ornamental design for a faucet handle, as shown and described.

**DESCRIPTION**

FIG. 1 is a perspective view of a faucet handle showing our new design;  
FIG. 2 is a front side elevational view thereof;  
FIG. 3 is a rear side elevational view thereof;  
FIG. 4 is a top plan view thereof;  
FIG. 5 is a bottom plan view thereof;  
FIG. 6 is a right side elevational view thereof;  
FIG. 7 is a left side elevational view thereof;  
FIG. 8 is a perspective view of an alternative mirror image embodiment of the faucet handle depicted in FIGS. 1-7;  
FIG. 9 is a front side elevational view thereof;  
FIG. 10 is a rear side elevational view thereof;  
FIG. 11 is a top plan view thereof;  
FIG. 12 is a bottom plan view thereof;  
FIG. 13 is a right side elevational view thereof; and,  
FIG. 14 is a left side elevational view thereof.

**1 Claim, 6 Drawing Sheets**

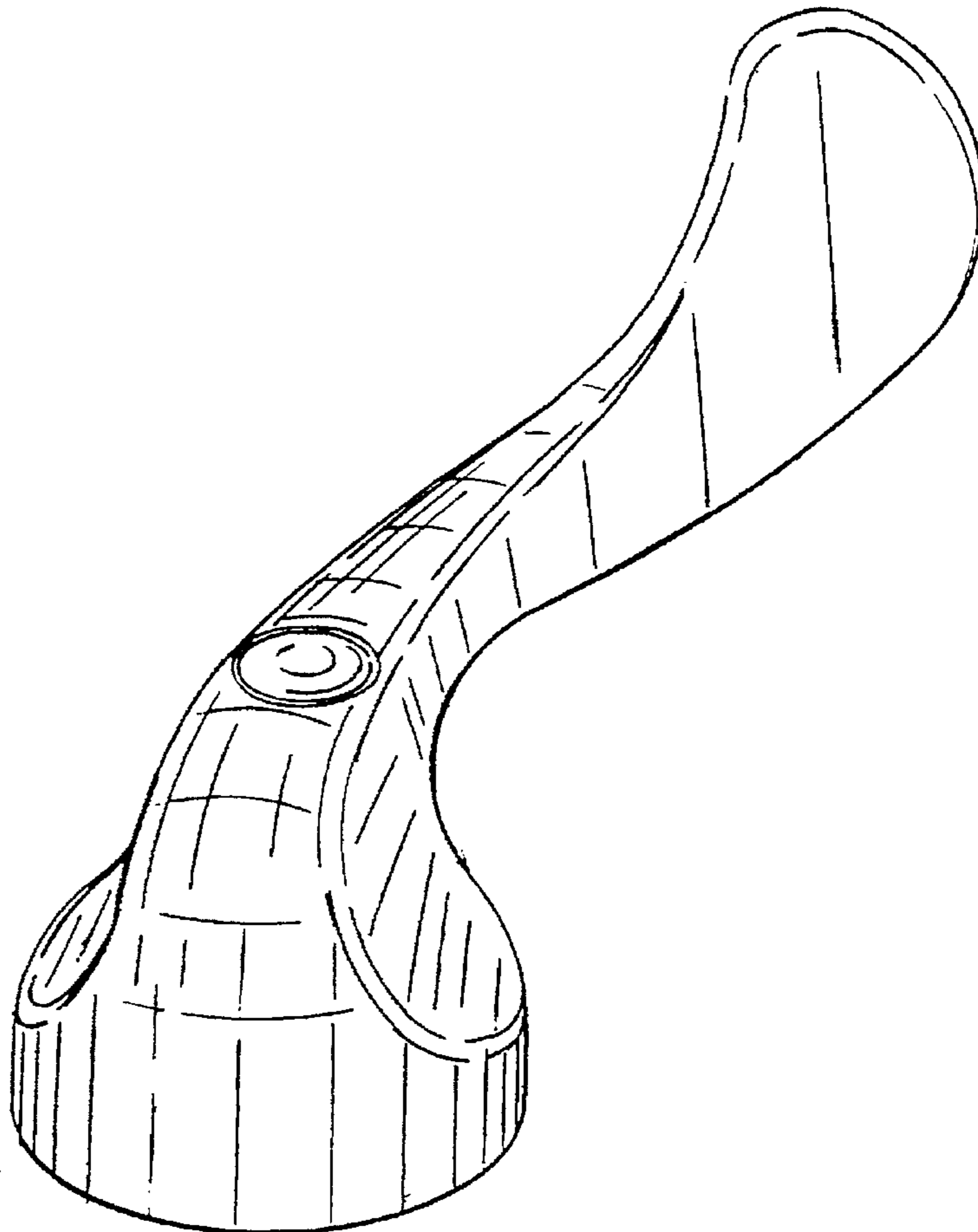

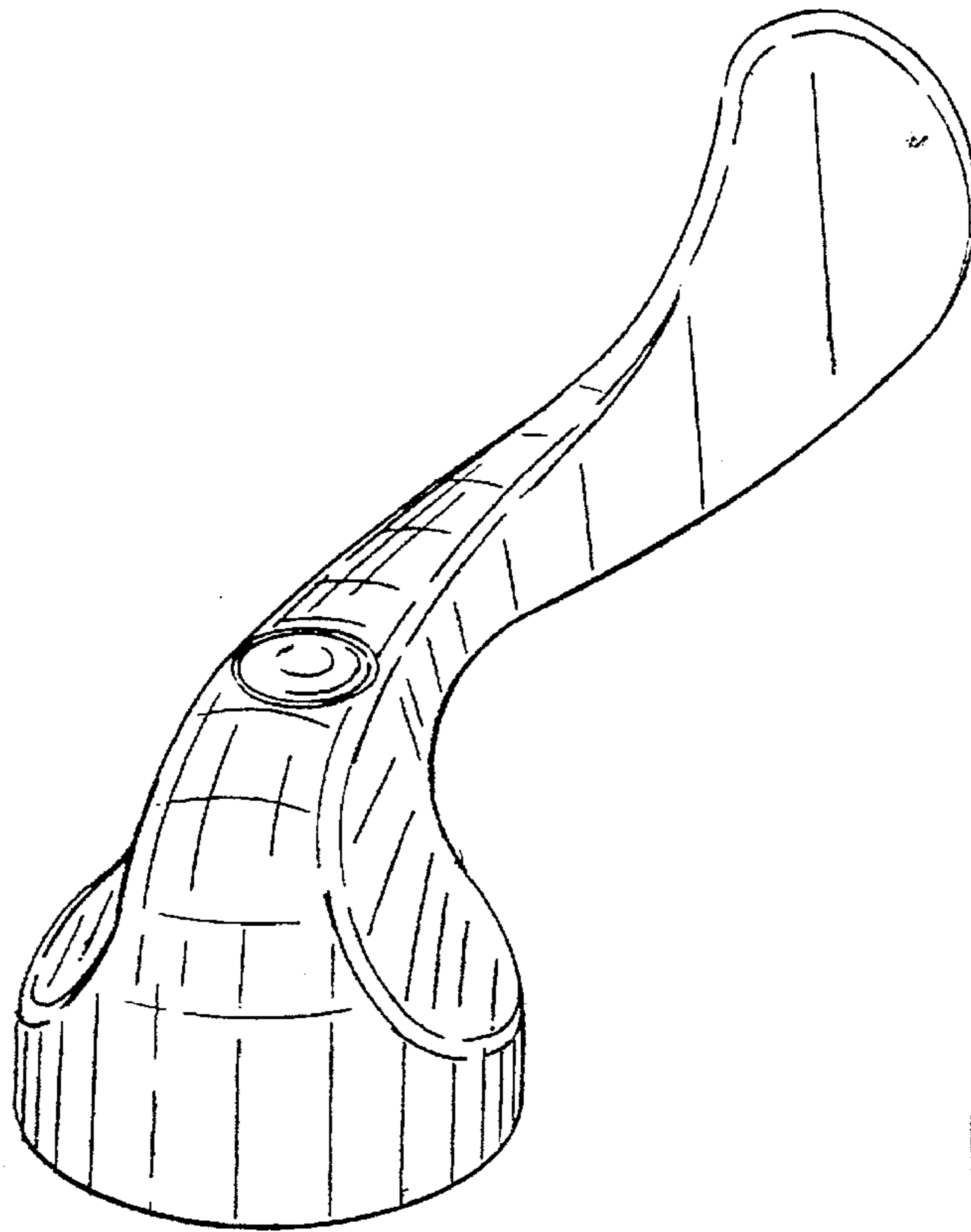

FIG. 1

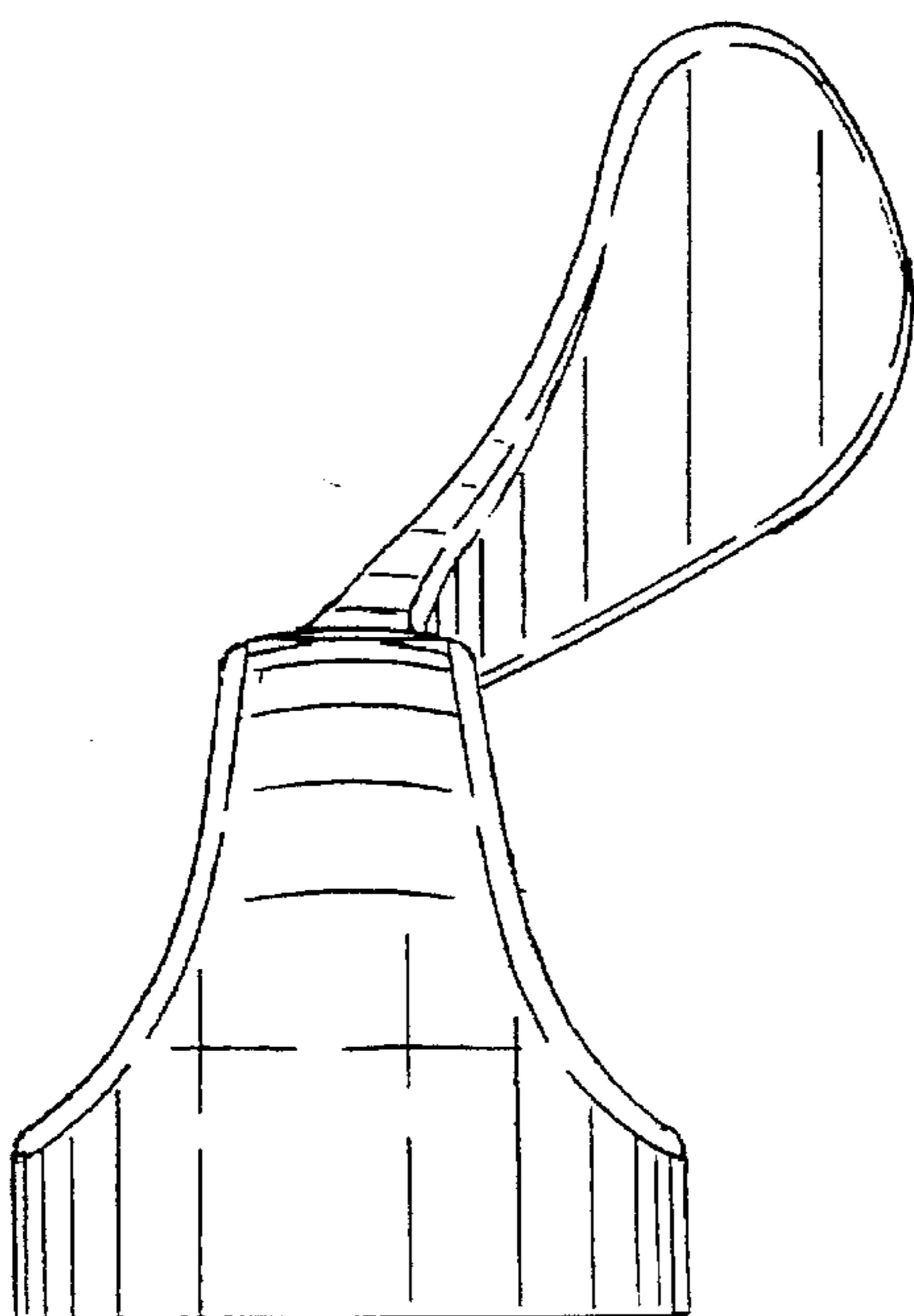

FIG. 2

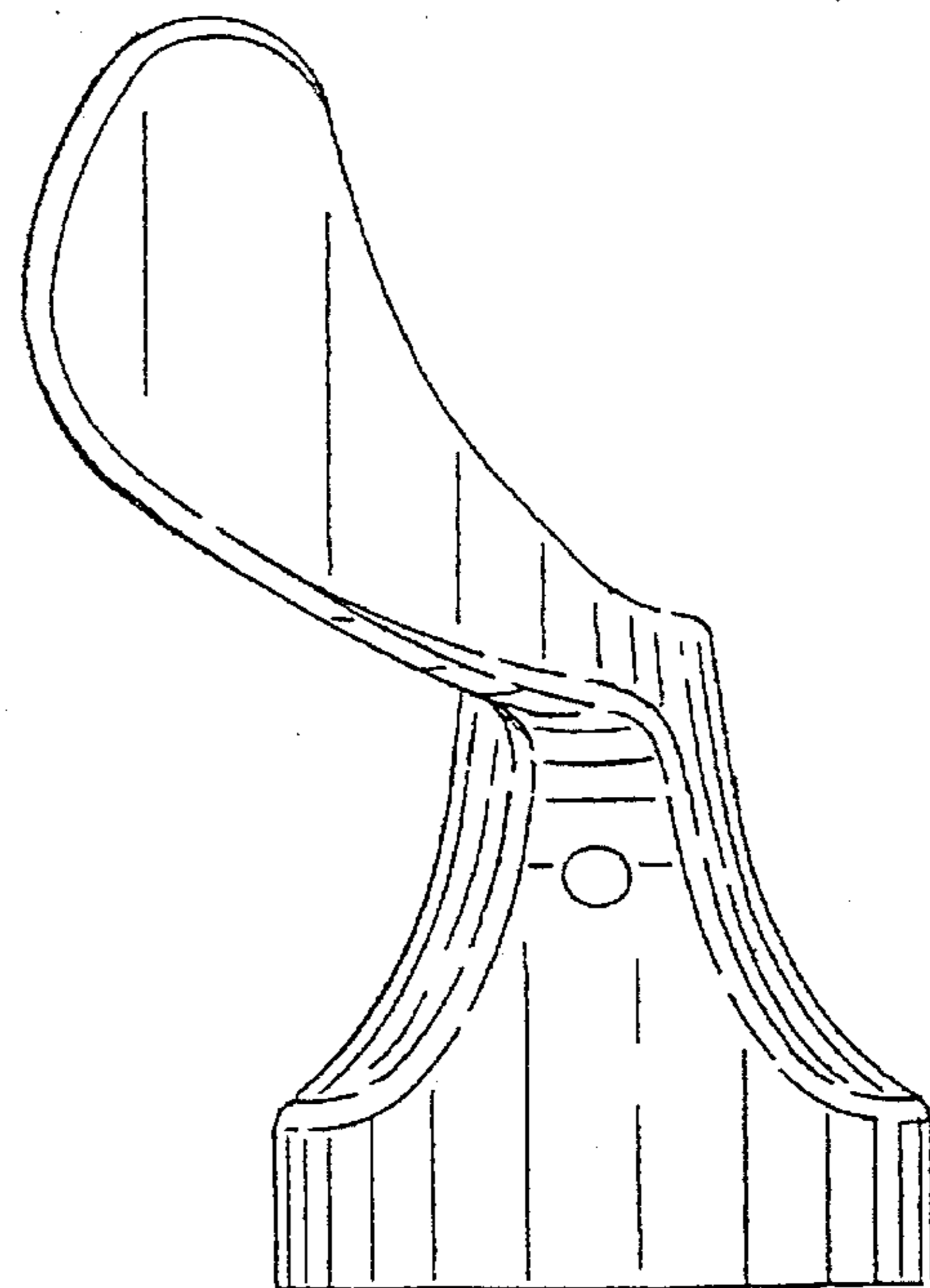

FIG. 3

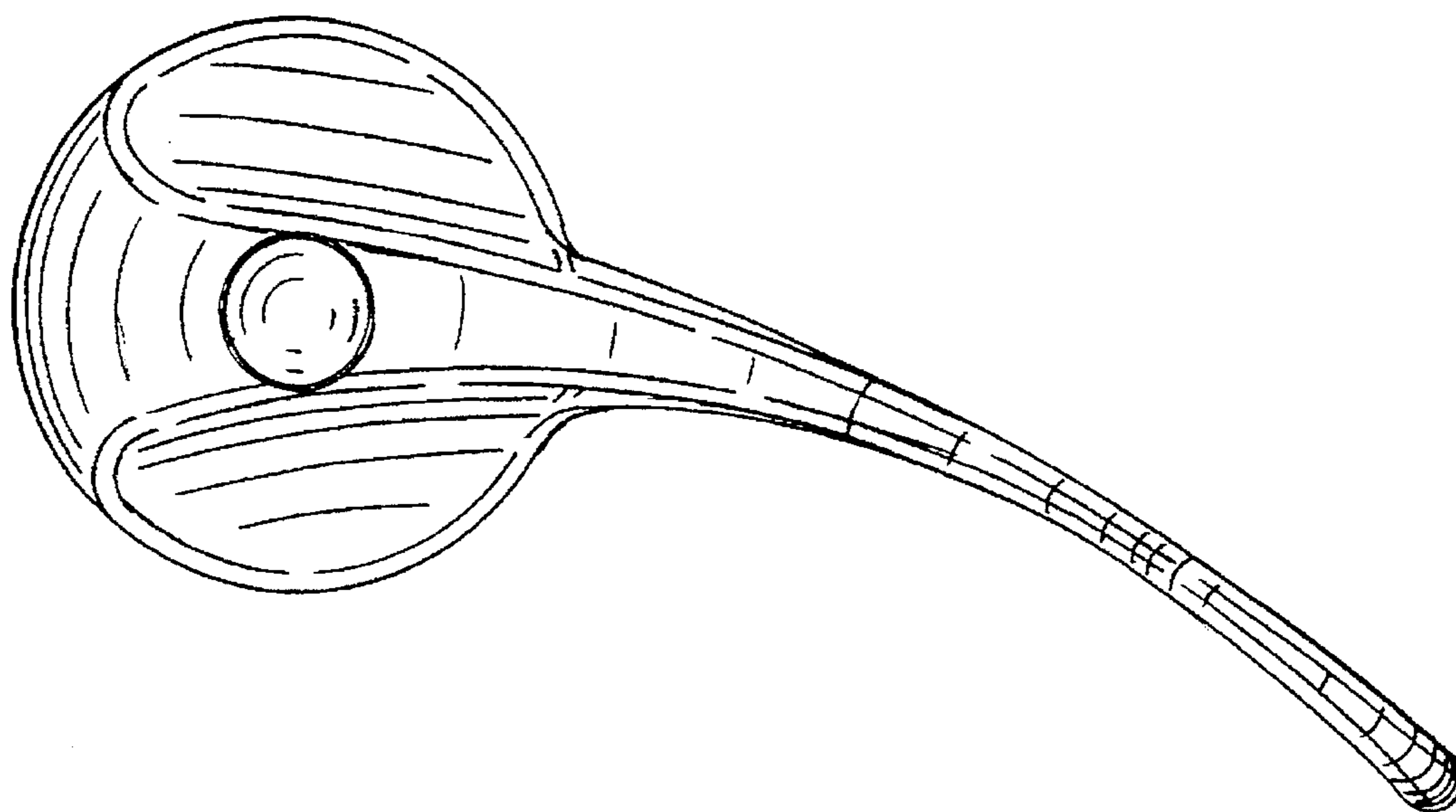

FIG. 4

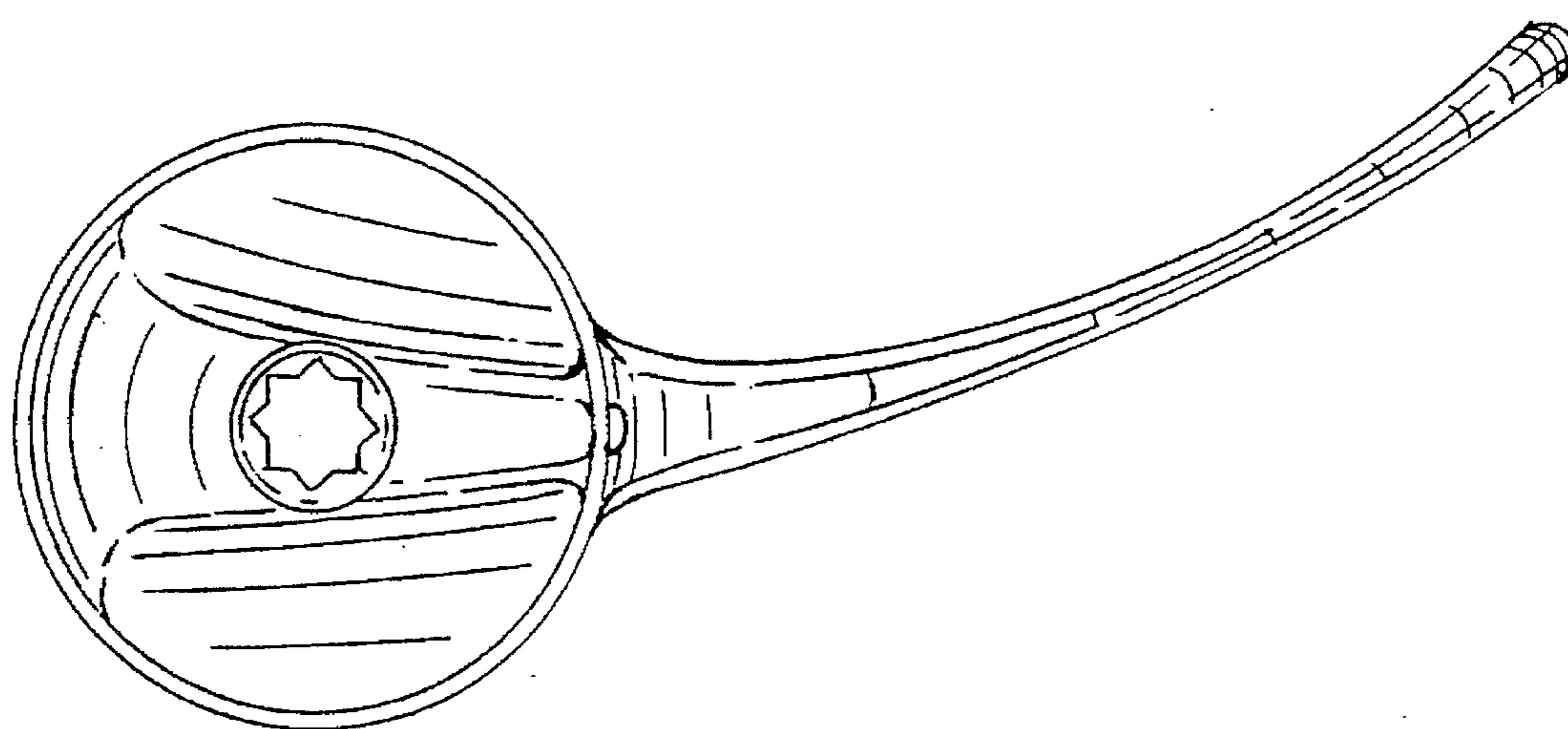

FIG. 5

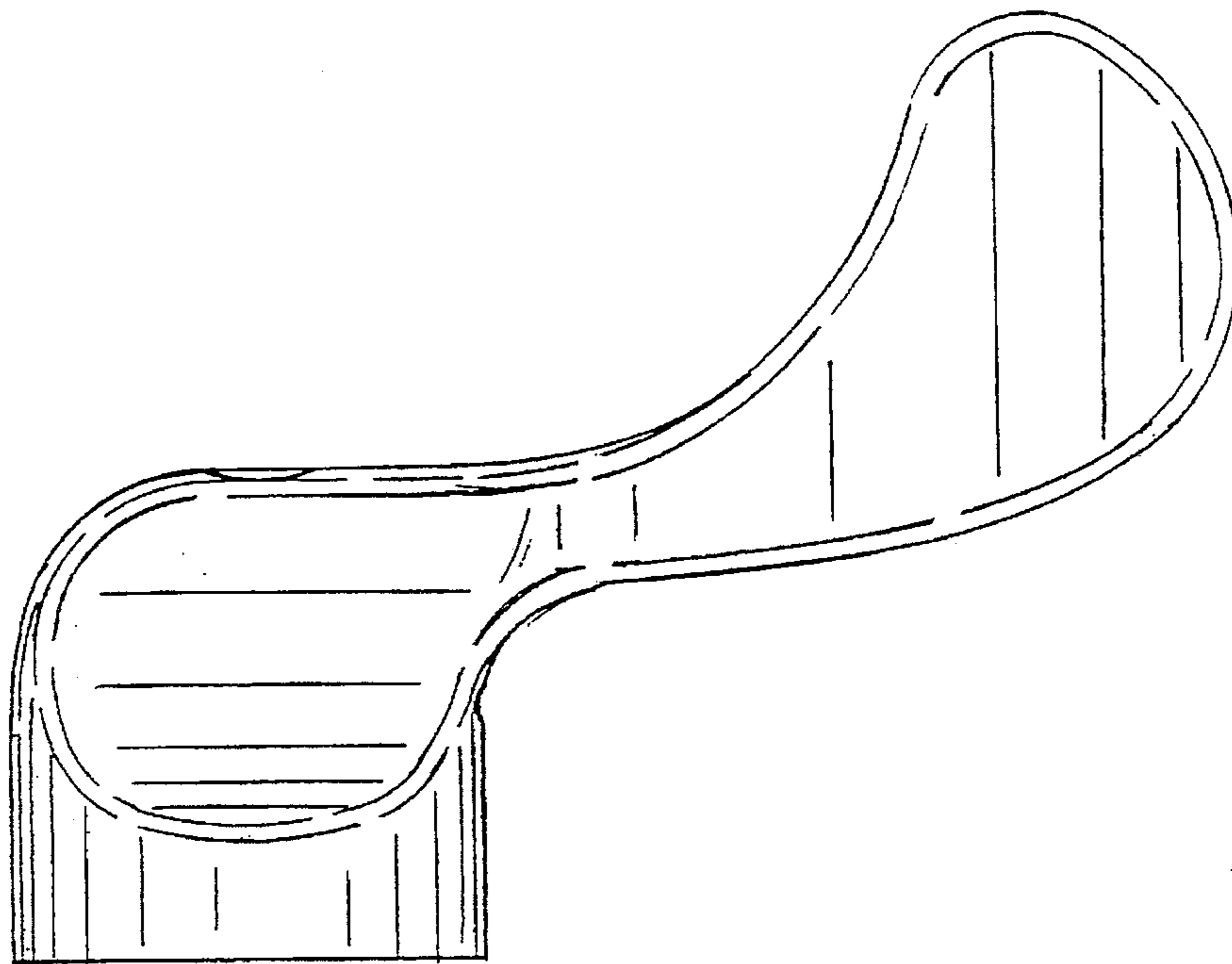

FIG. 6

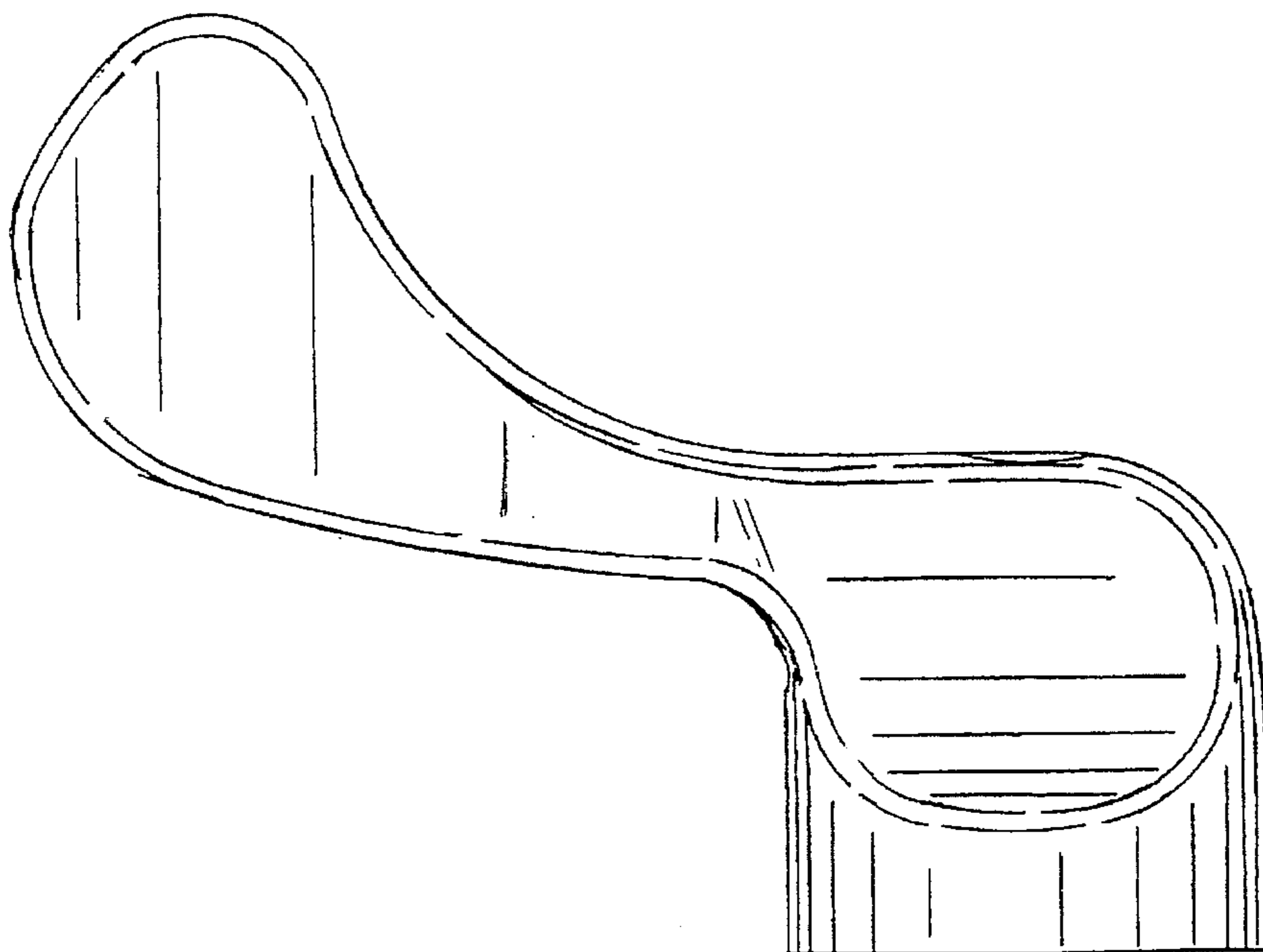

FIG. 7

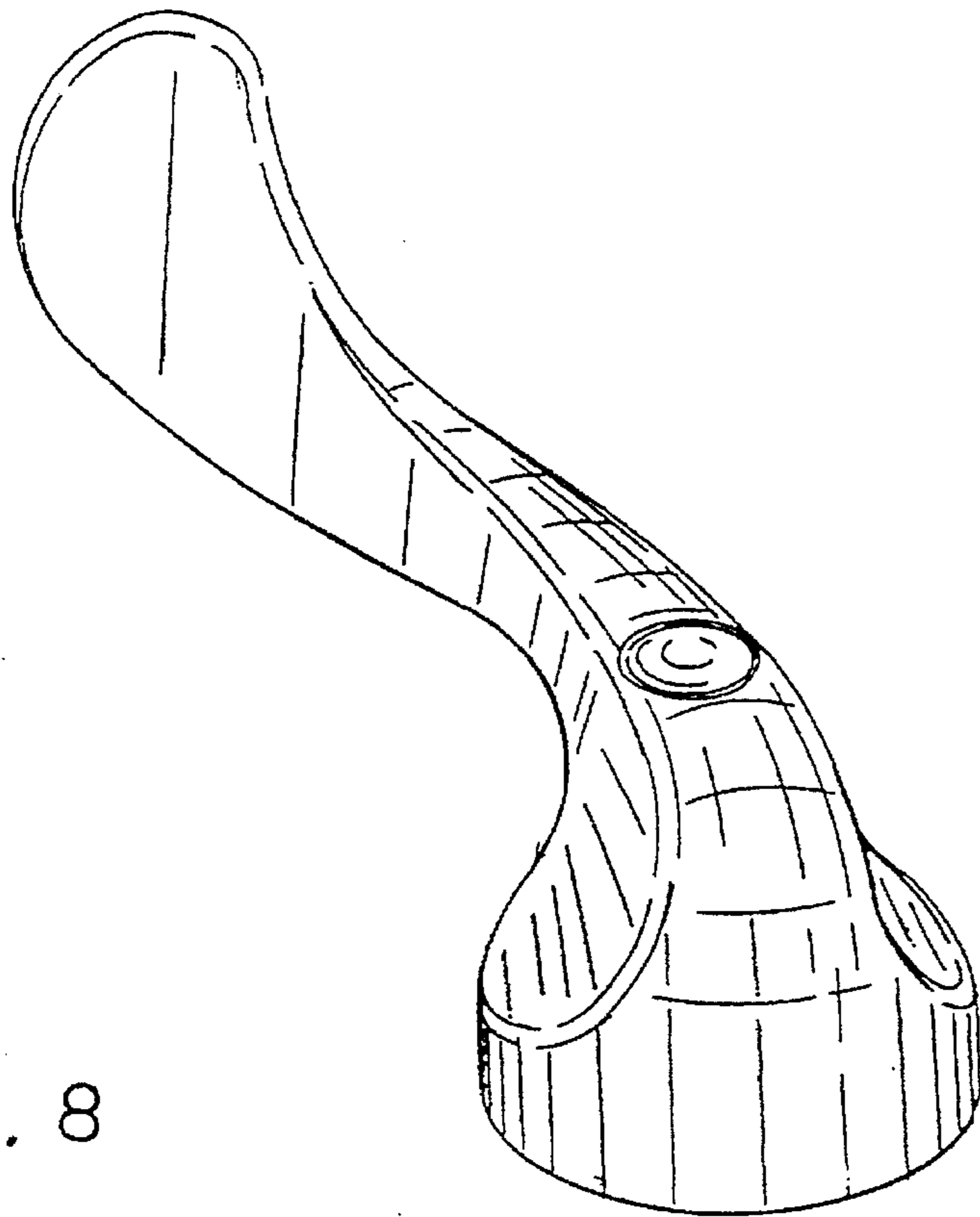

FIG. 8

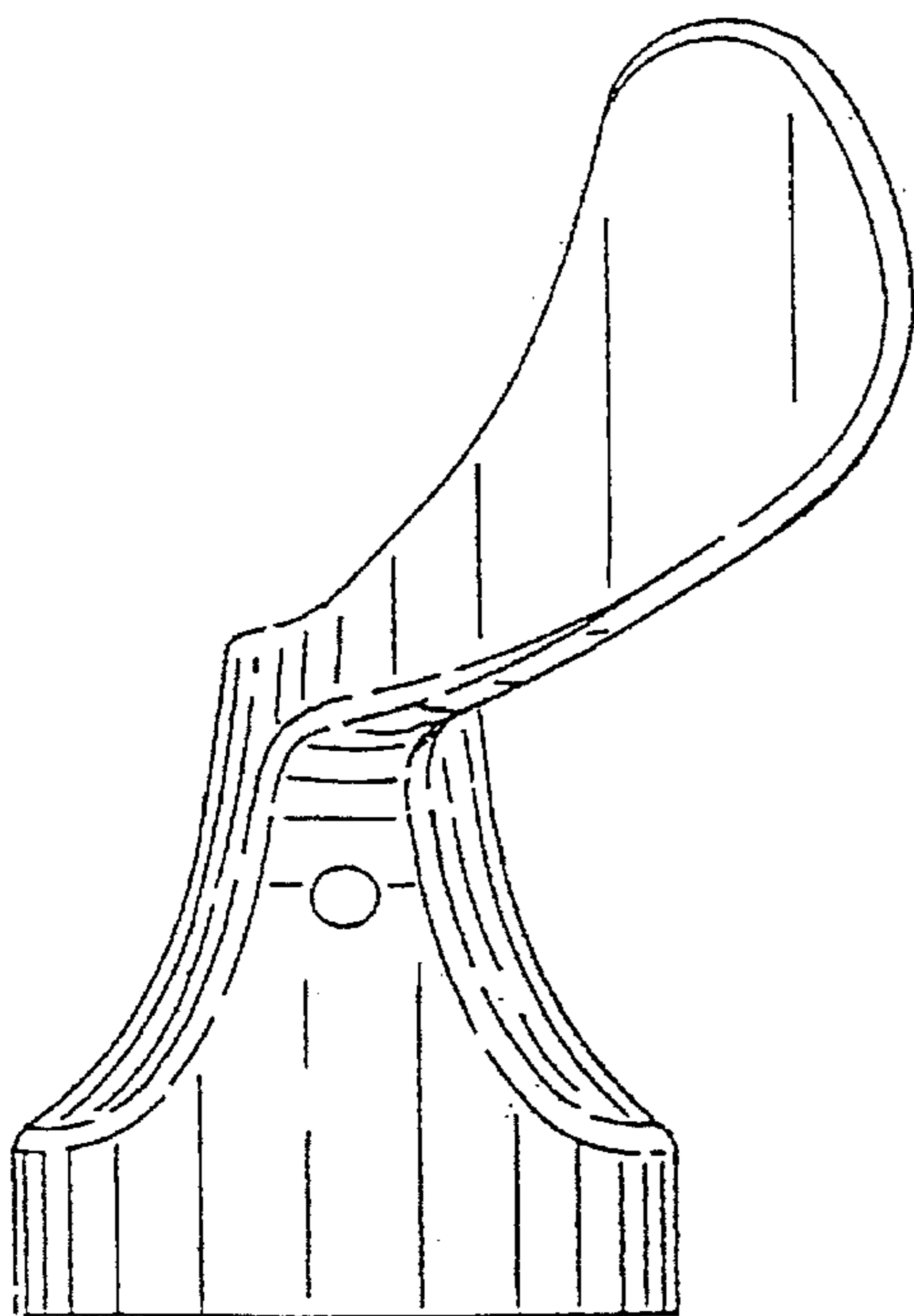

FIG. 10

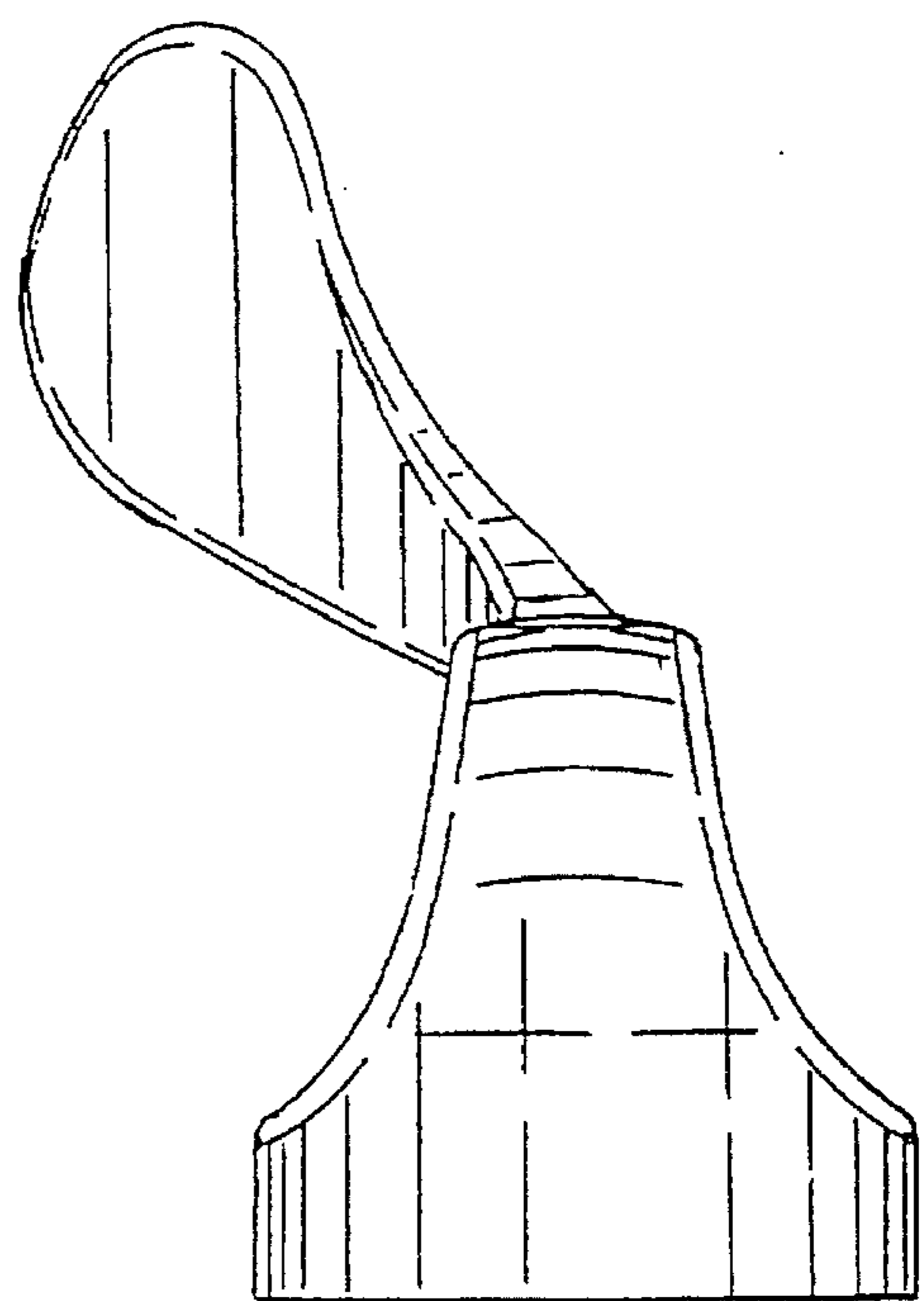

FIG. 9

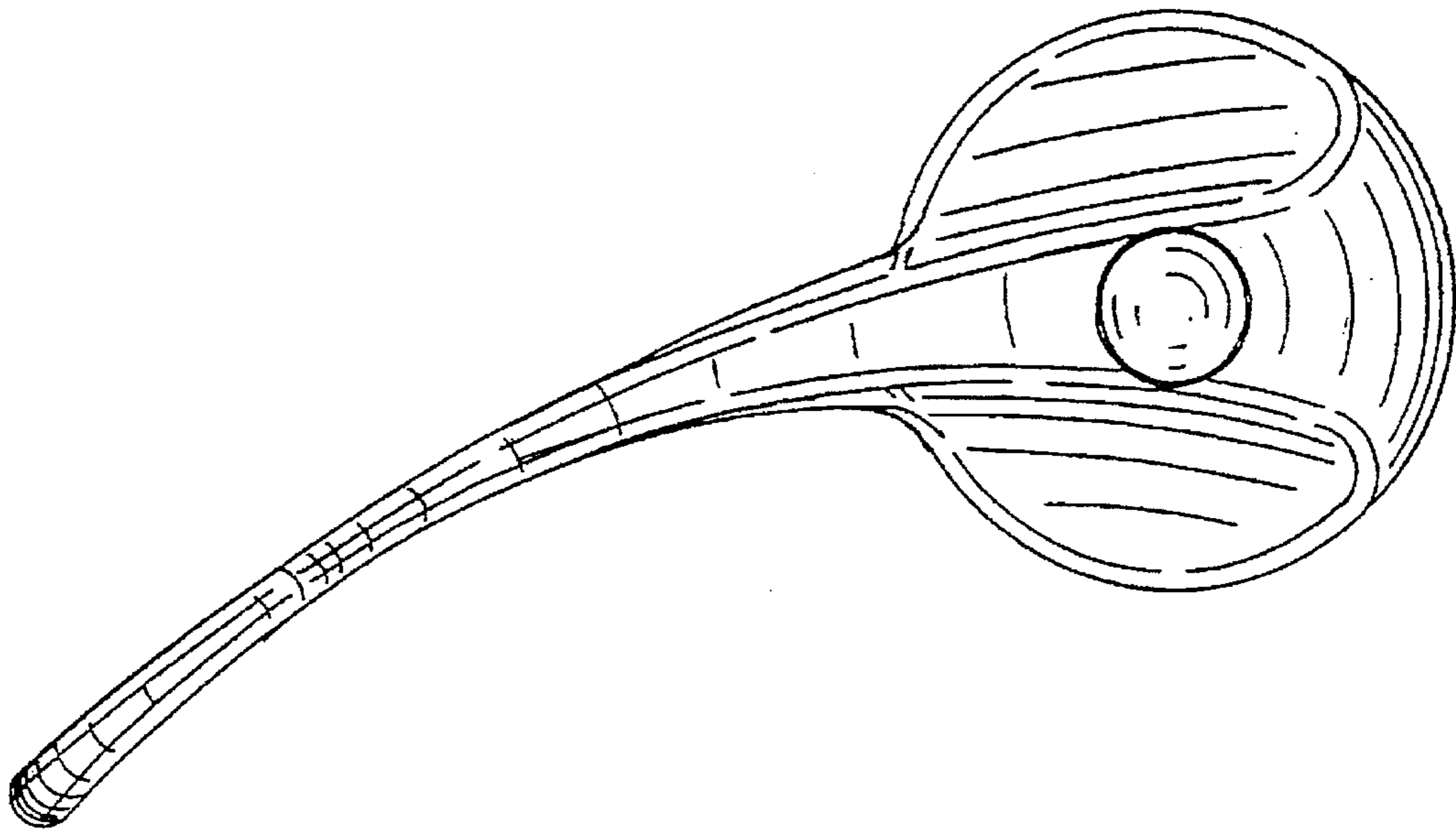

FIG. 11

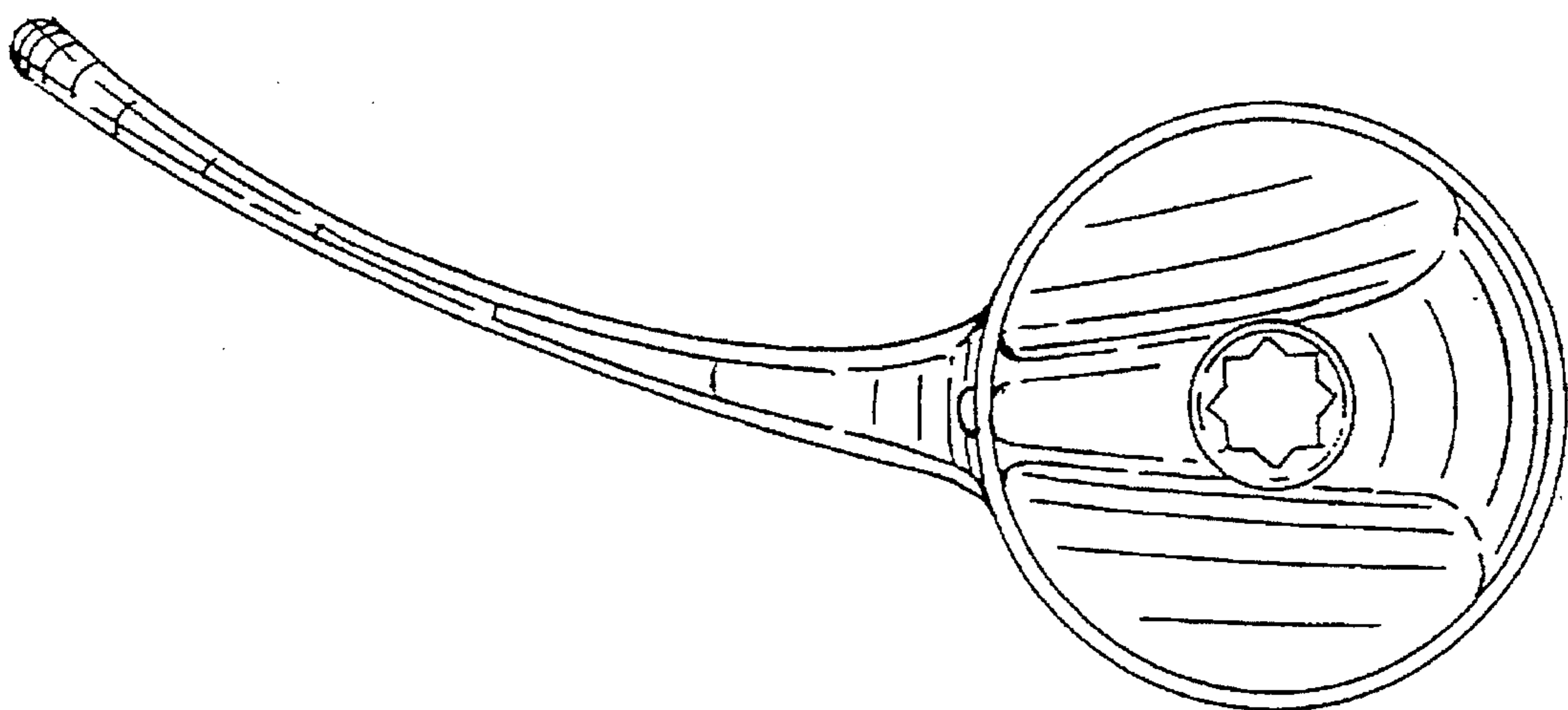

FIG. 12

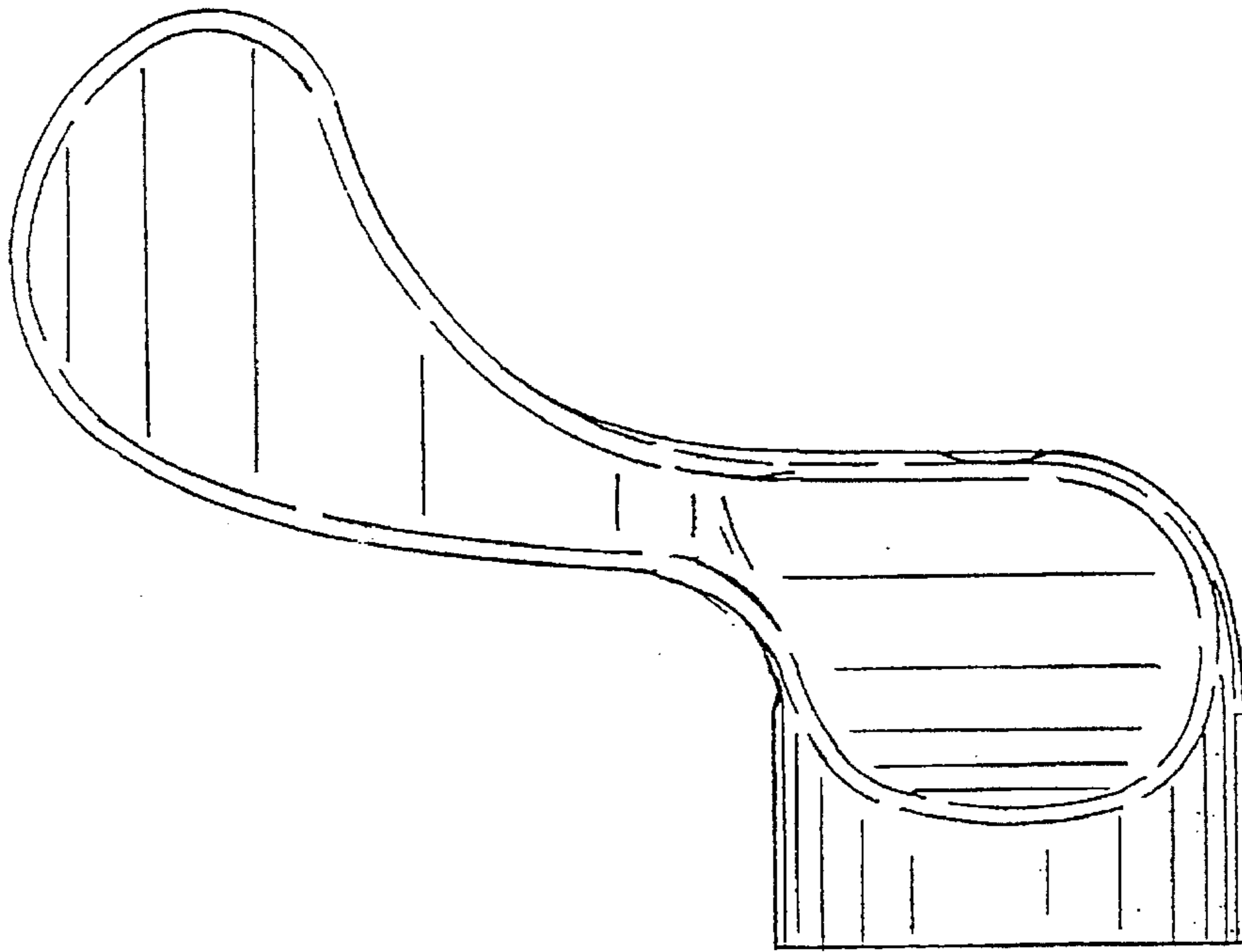

FIG. 13

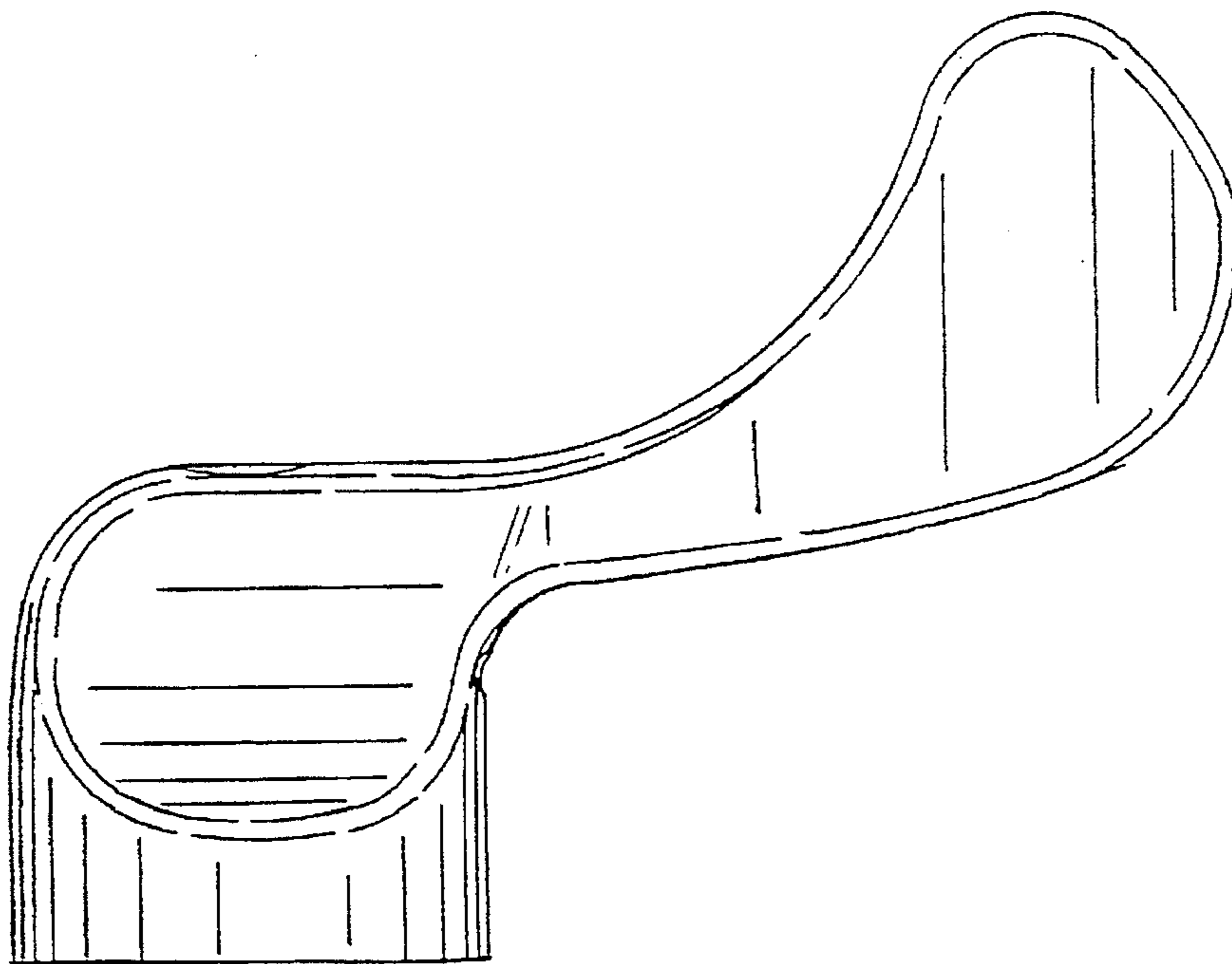

FIG. 14