



US00D380006S

United States Patent [19]

Takahashi et al.

[11] Patent Number: **Des. 380,006**

[45] Date of Patent: ****Jun. 17, 1997**

[54] **COPYING MACHINE**

[75] Inventors: **Masaki Takahashi**, Yokohama; **Hiroki Umeda**, Kawasaki, both of Japan

[73] Assignee: **Canon Kabushiki Kaisha**, Tokyo, Japan

[**] Term: **14 Years**

[21] Appl. No.: **42,698**

[22] Filed: **Aug. 15, 1995**

[30] Foreign Application Priority Data

Feb. 17, 1995 [JP] Japan 7-4161

[51] LOC (6) Cl. **16-03**

[52] U.S. Cl. **D18/39; D18/36**

[58] Field of Search D18/36-39; D14/111, D14/112, 116, 118; 355/200, 210, 231, 233-236, 245, 260, 326-328

[56] References Cited

U.S. PATENT DOCUMENTS

D. 292,592 11/1987 Kosako D18/36

| | | | | |
|------------|---------|---------------|-------|--------|
| D. 292,593 | 11/1987 | Morozumi | | D18/37 |
| D. 300,225 | 3/1989 | Morozumi | | D18/37 |
| D. 317,460 | 6/1991 | Tani et al. | | D18/36 |
| D. 354,509 | 1/1995 | Komada et al. | | D18/36 |
| D. 362,675 | 9/1995 | Umeda et al. | | D18/39 |

Primary Examiner—Nelson C. Holtje
Assistant Examiner—Caron D. Veynar
Attorney, Agent, or Firm—Fitzpatrick, Cella, Harper & Scinto

[57] CLAIM

The ornamental design for a copying machine, as shown and described.

DESCRIPTION

FIG. 1 is a front elevational view of a copying machine showing our new design;
FIG. 2 is a rear elevational view thereof;
FIG. 3 is a top plan view thereof;
FIG. 4 is a bottom plan view thereof;
FIG. 5 is a left side elevational view thereof;
FIG. 6 is a right side elevational view thereof; and,
FIG. 7 is a perspective view thereof.

1 Claim, 4 Drawing Sheets

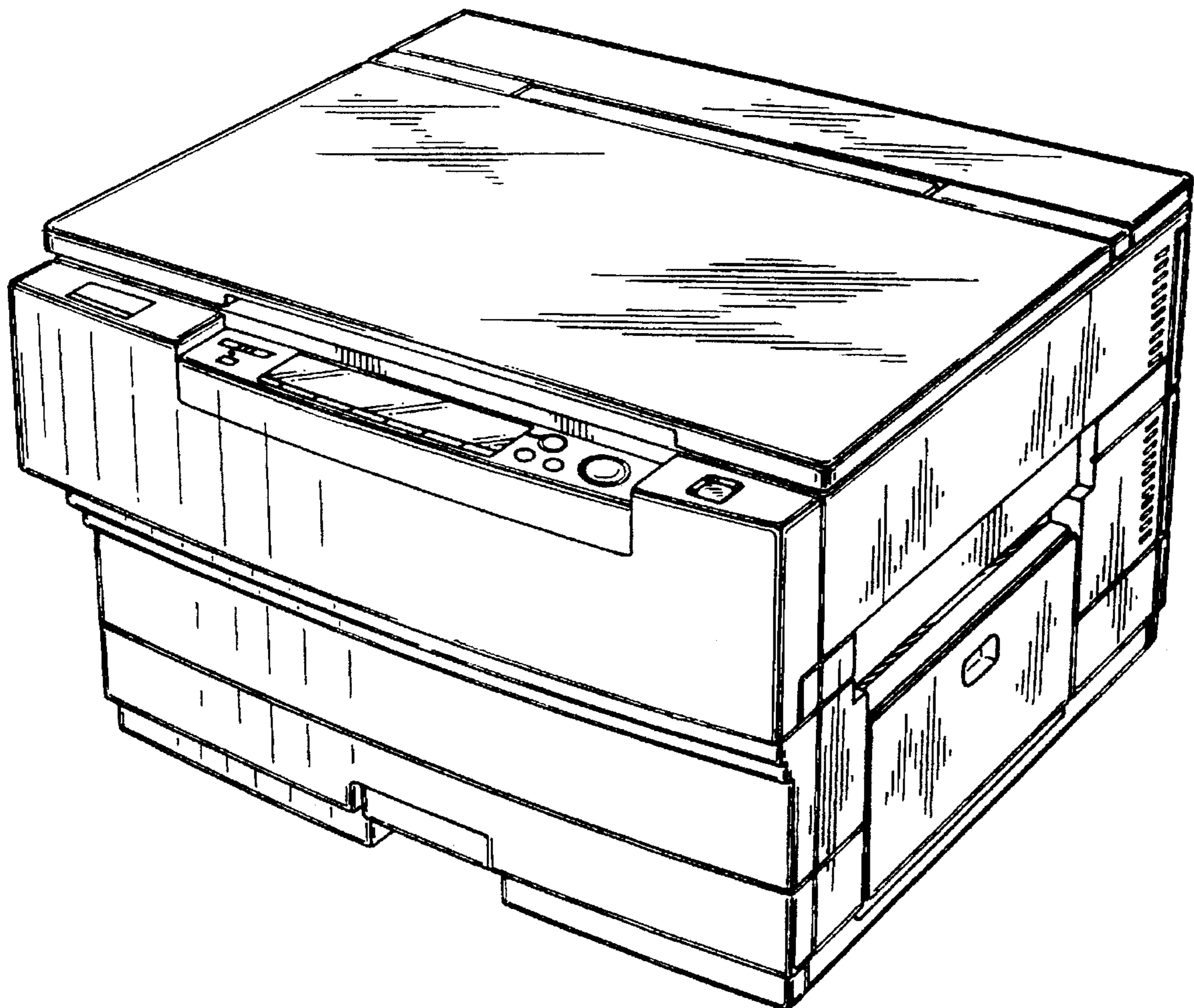

FIG. 1

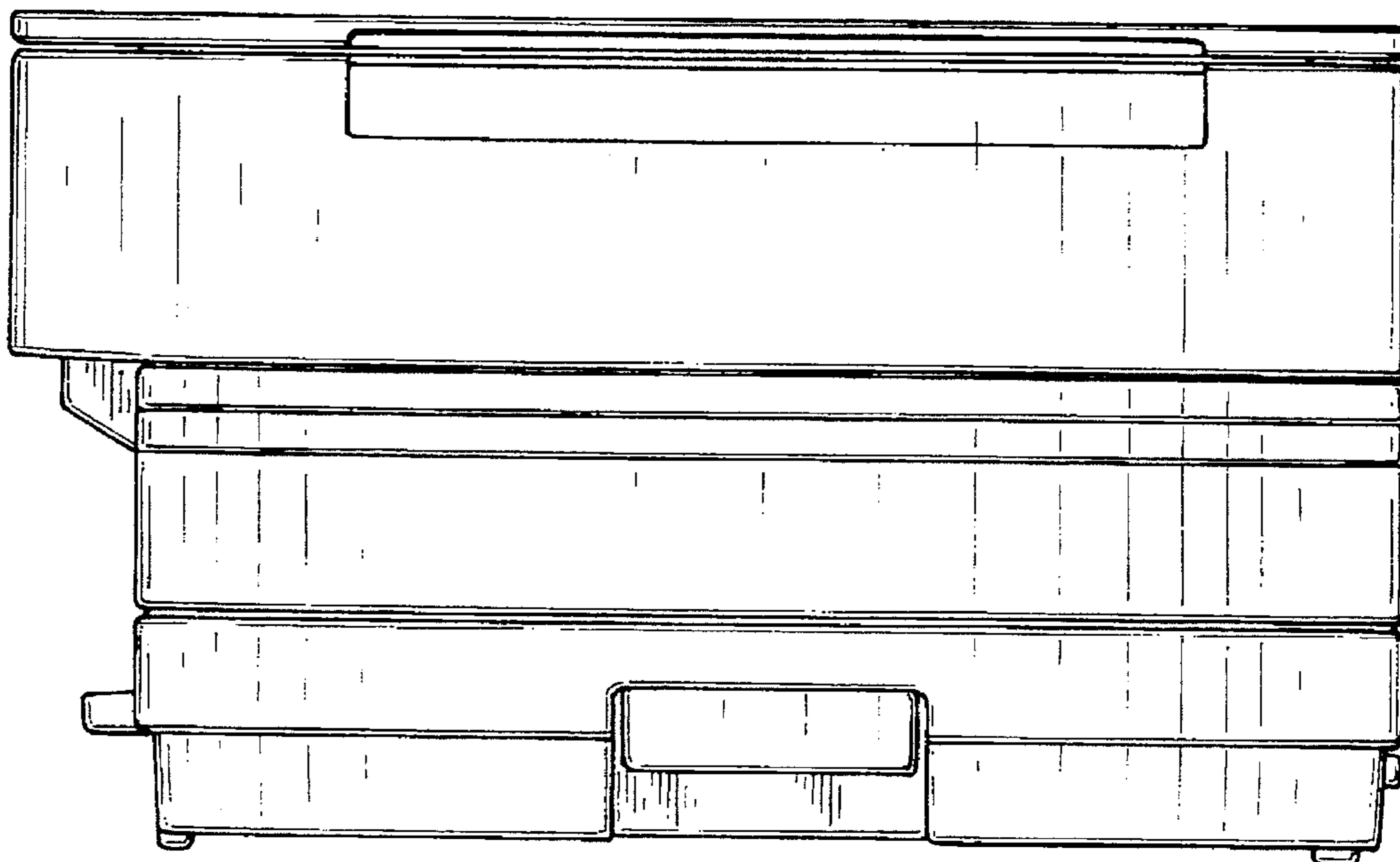

FIG. 2

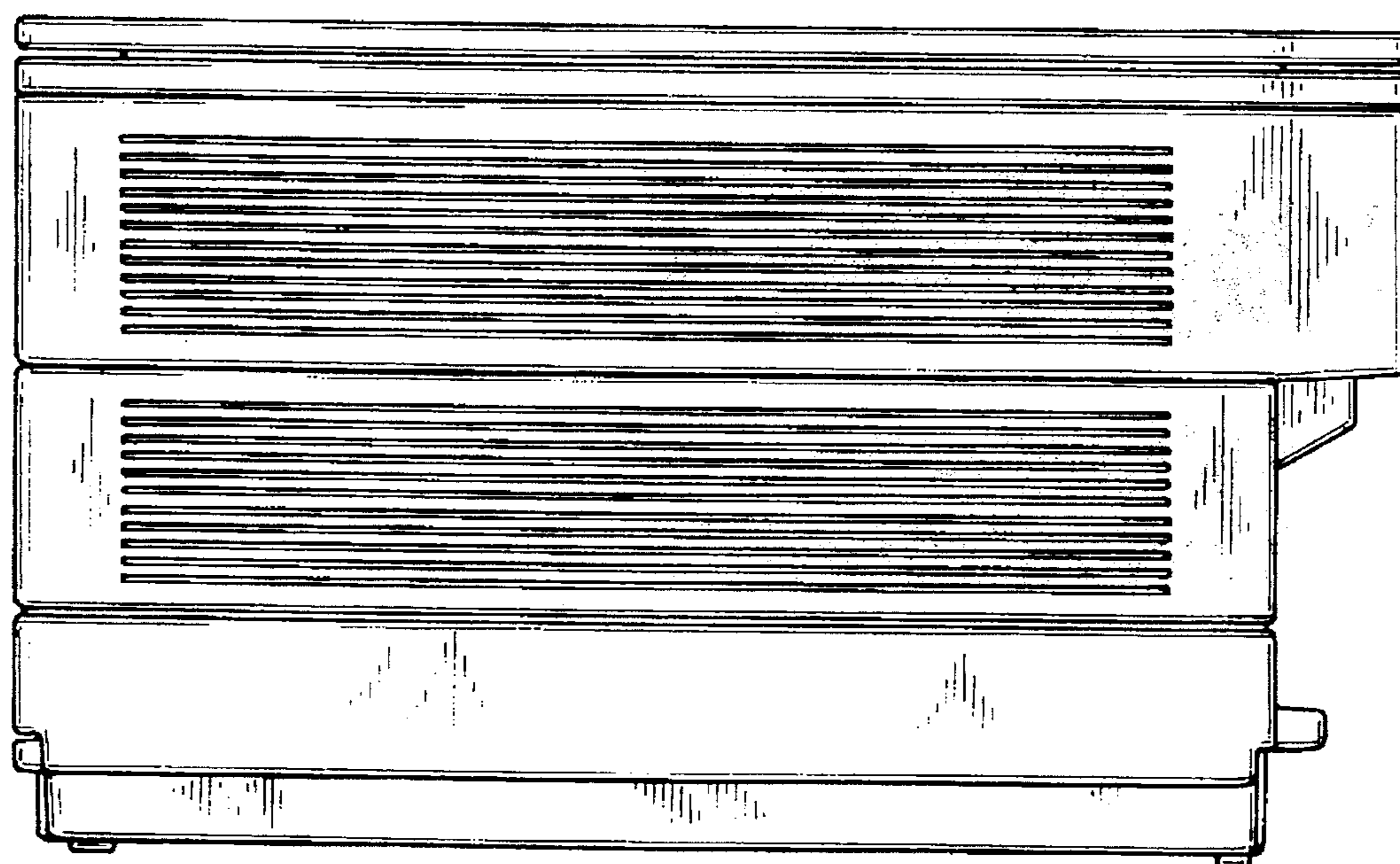

FIG. 3

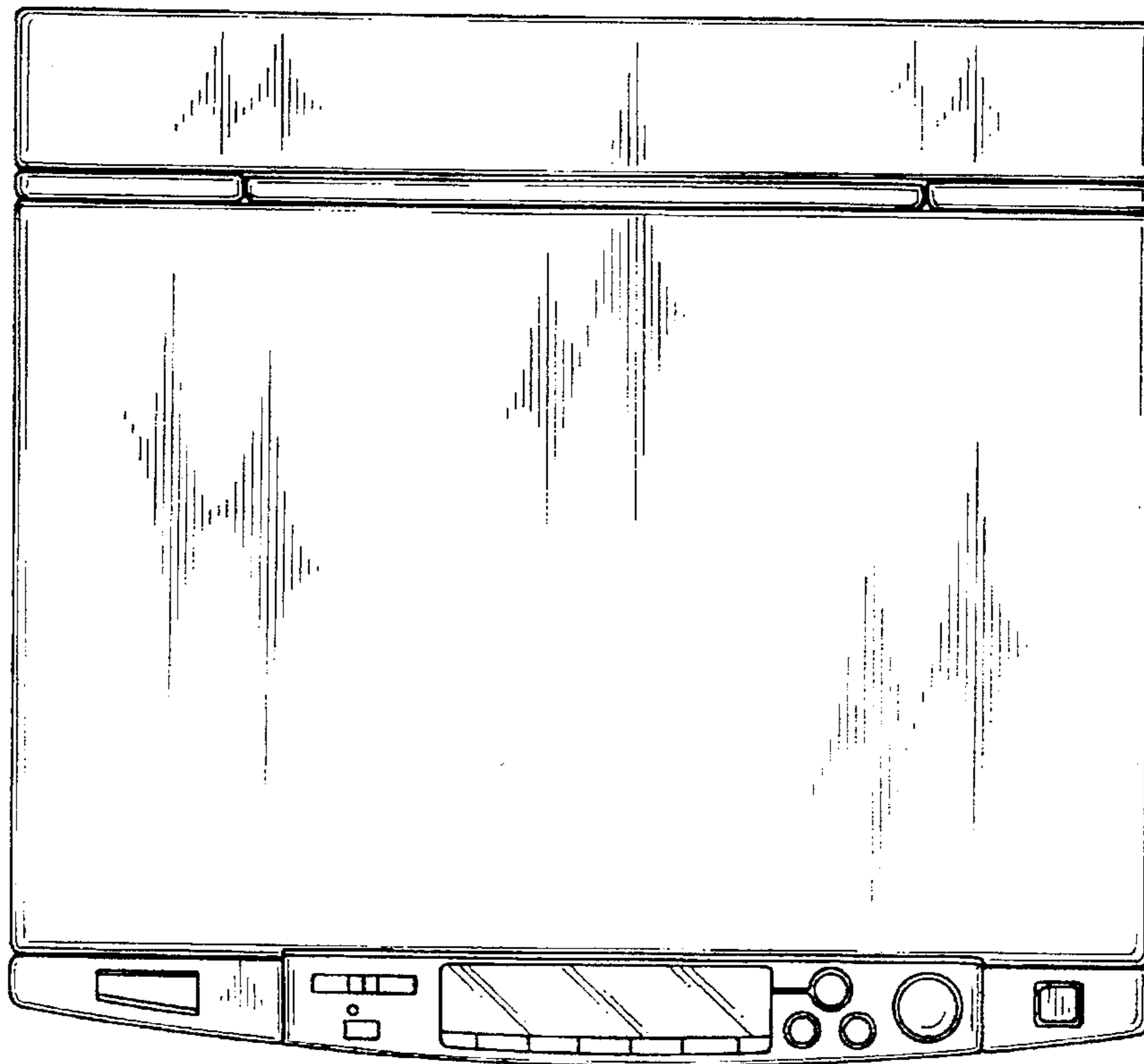

FIG. 4

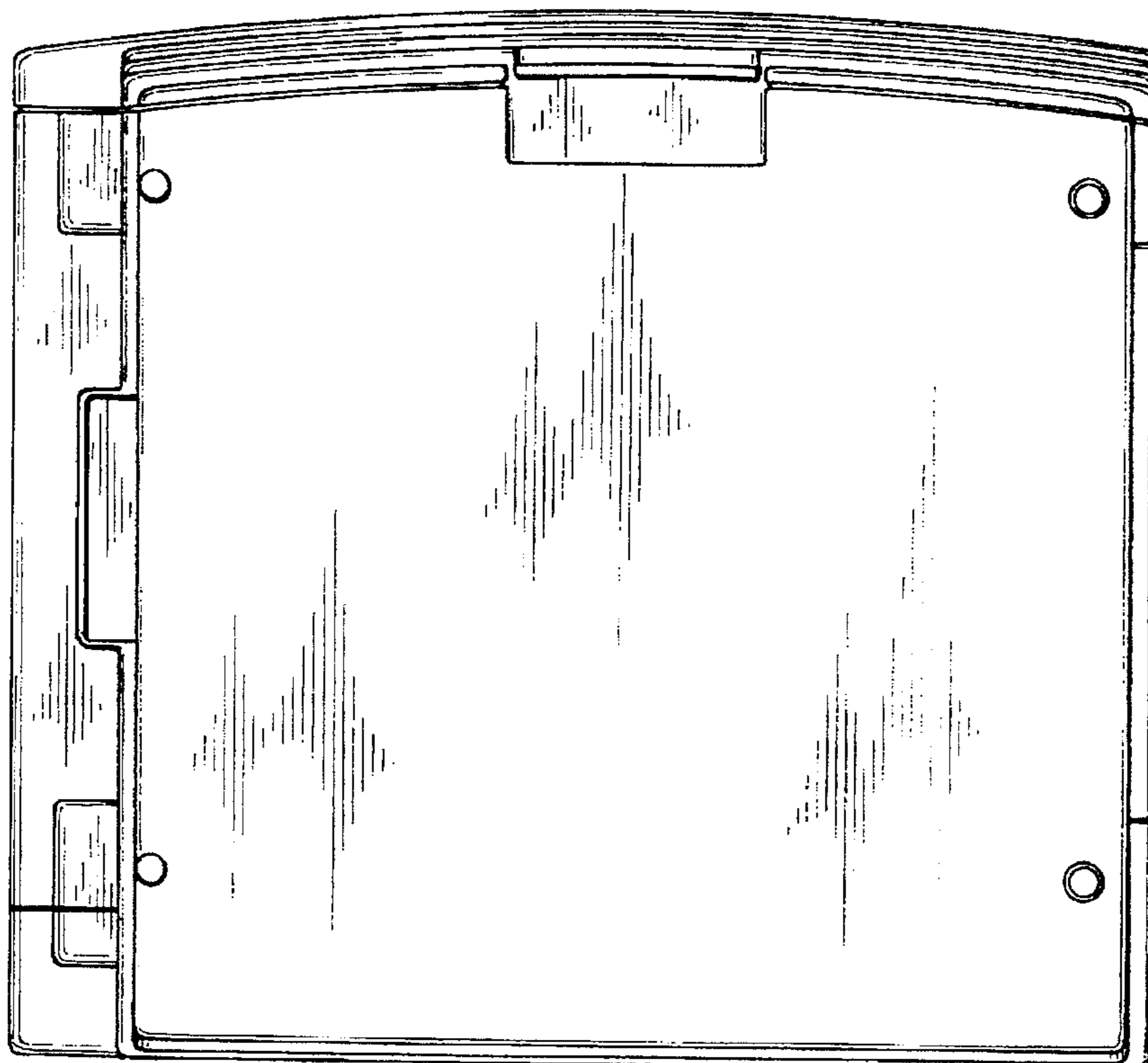

FIG. 5

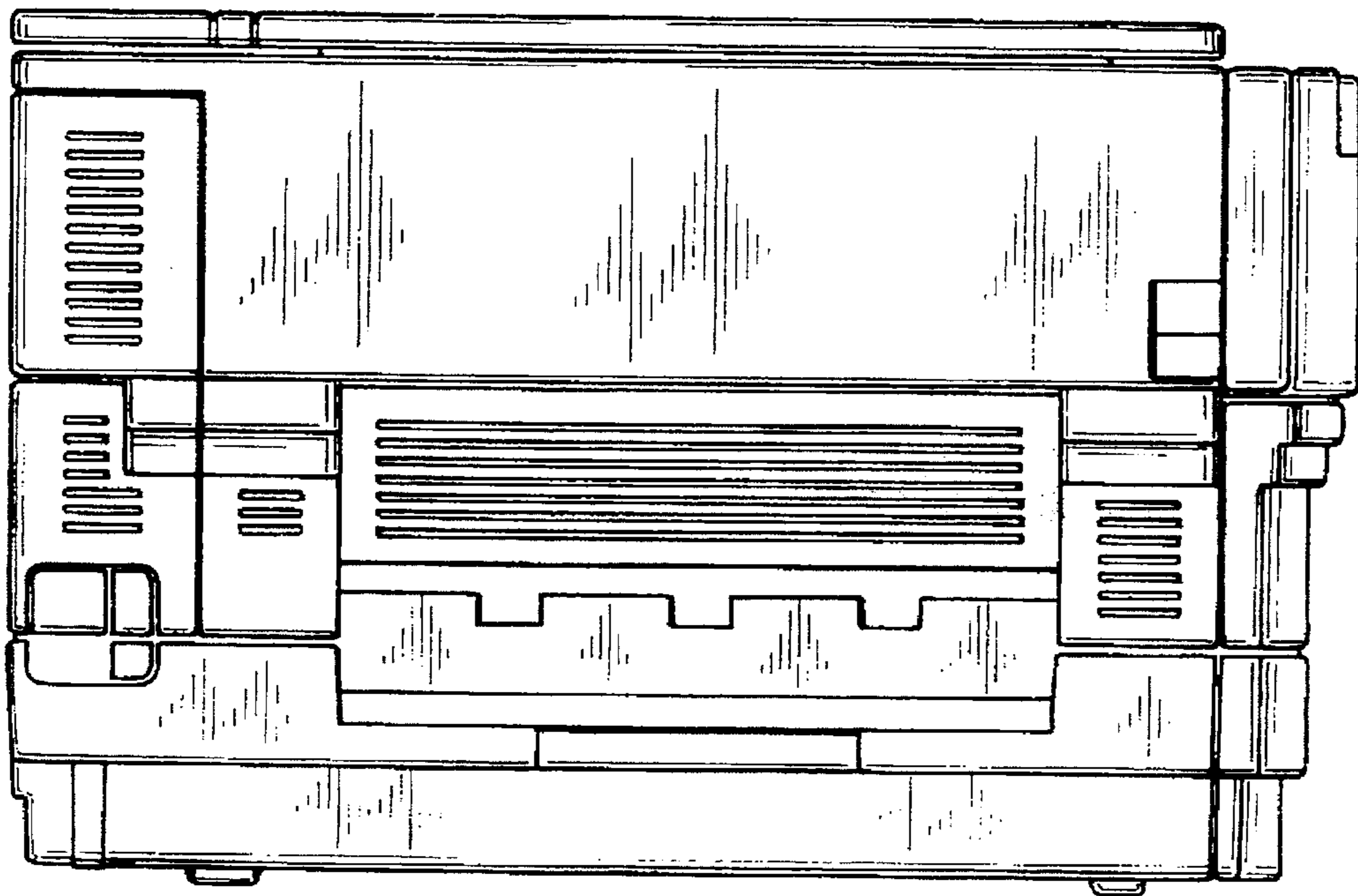

FIG. 6

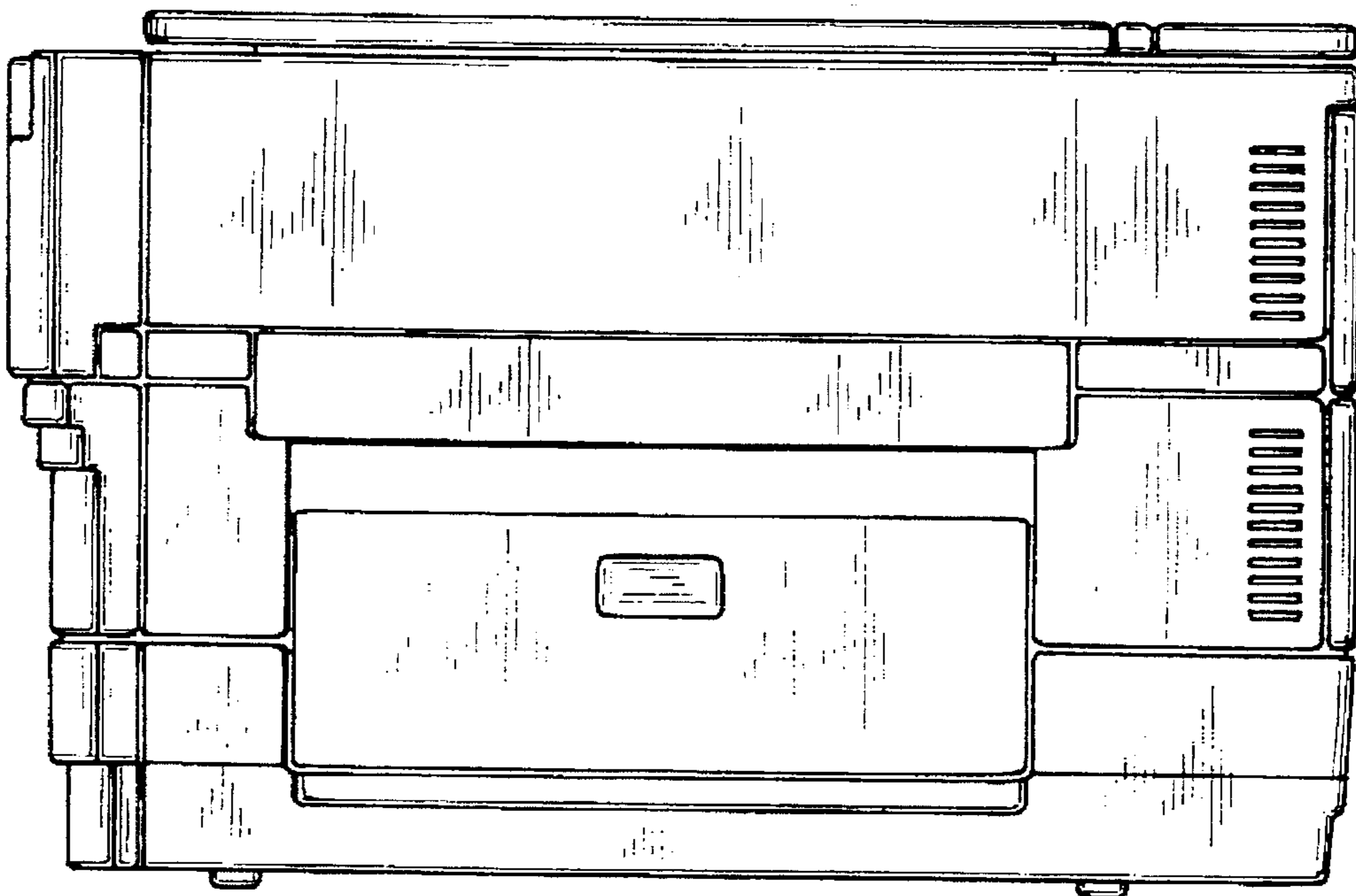

FIG. 7

