



US00D380002S

# United States Patent [19] Schelling

[11] Patent Number: **Des. 380,002**  
[45] Date of Patent: **\*\*Jun. 17, 1997**

[54] **CAMERA WITH LENS COVER**  
[75] Inventor: **Anna Cecilia Schelling**, Geneva, N.Y.  
[73] Assignee: **Eastman Kodak Company**, Rochester, N.Y.  
[\*\*] Term: **14 Years**  
[21] Appl. No.: **49,400**  
[22] Filed: **Jan. 24, 1996**  
[51] LOC (6) Cl. .... **16-01**  
[52] U.S. Cl. .... **D16/209; D16/218**  
[58] Field of Search ..... **D16/200-205, D16/208, 209, 216-218; 354/126, 149.11, 202, 288**

*Primary Examiner*—Prabhakar G. Deshmukh  
*Assistant Examiner*—Adir Aronovich  
*Attorney, Agent, or Firm*—Roger A. Fields

### [57] CLAIM

The ornamental design for a camera with lens cover, as shown and described.

### DESCRIPTION

FIG. 1 is a front, top, right-side perspective view of a camera with lens cover opened, showing my new design;  
FIG. 2 is a rear, bottom, left-side perspective view thereof;  
FIG. 3 is a front elevation view thereof;  
FIG. 4 is a rear elevation view thereof;  
FIG. 5 is a top plan view thereof;  
FIG. 6 is a bottom plan view thereof;  
FIG. 7 is a right-side elevation view thereof;  
FIG. 8 is a left-side elevation view thereof;  
FIG. 9 is a front, top, right-side perspective view of a camera with a lens cover closed, showing my new design;  
FIG. 10 is a front elevation view thereof;  
FIG. 11 is a top plan view thereof;  
FIG. 12 is a bottom plan view thereof; and,  
FIG. 13 is a right-side elevation view thereof.

[56] **References Cited**  
**U.S. PATENT DOCUMENTS**  
D. 323,523 1/1992 Tanaka et al. .... D16/218  
D. 345,987 4/1994 Nihei ..... D16/209  
D. 356,808 3/1995 Nagaoka ..... D16/209  
D. 369,820 5/1996 Chapman et al. .... D16/209  
4,943,822 7/1990 von Braunhut ..... 354/288  
**OTHER PUBLICATIONS**

Evans Catalog, 1988-1989, p. 305Y (Canon's 35 mm camera).

**1 Claim, 13 Drawing Sheets**

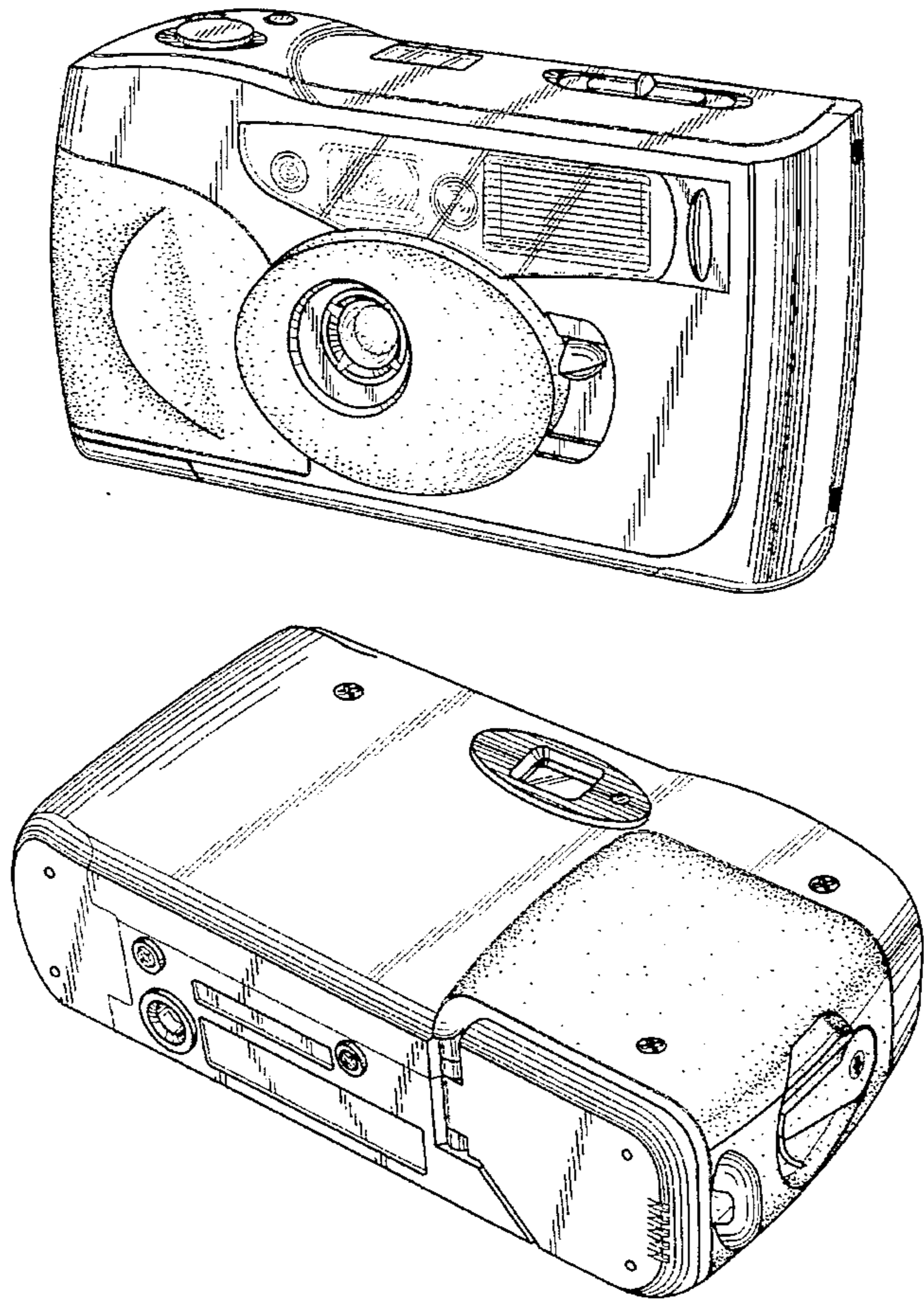

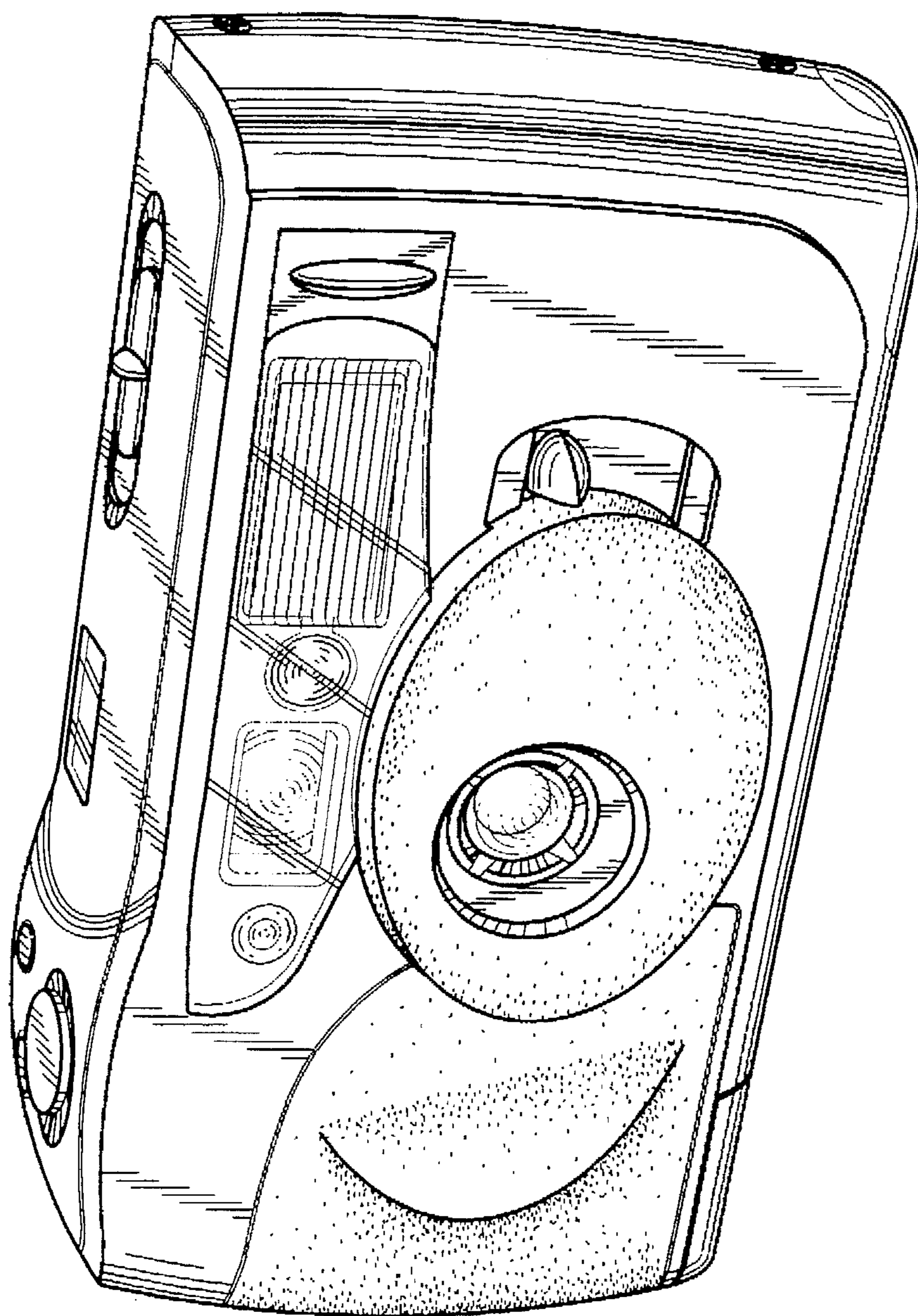

**FIG. 1**

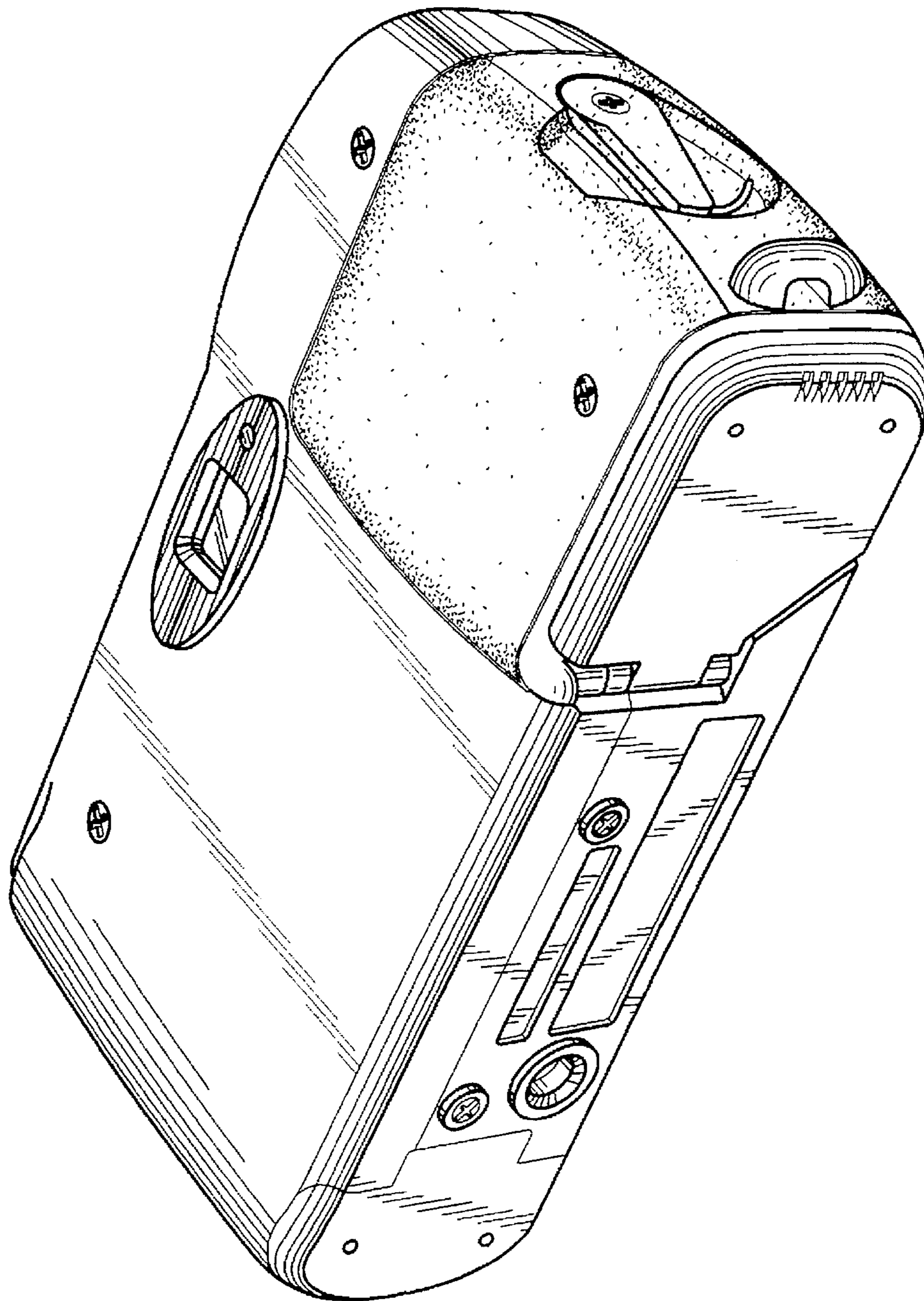

FIG. 2

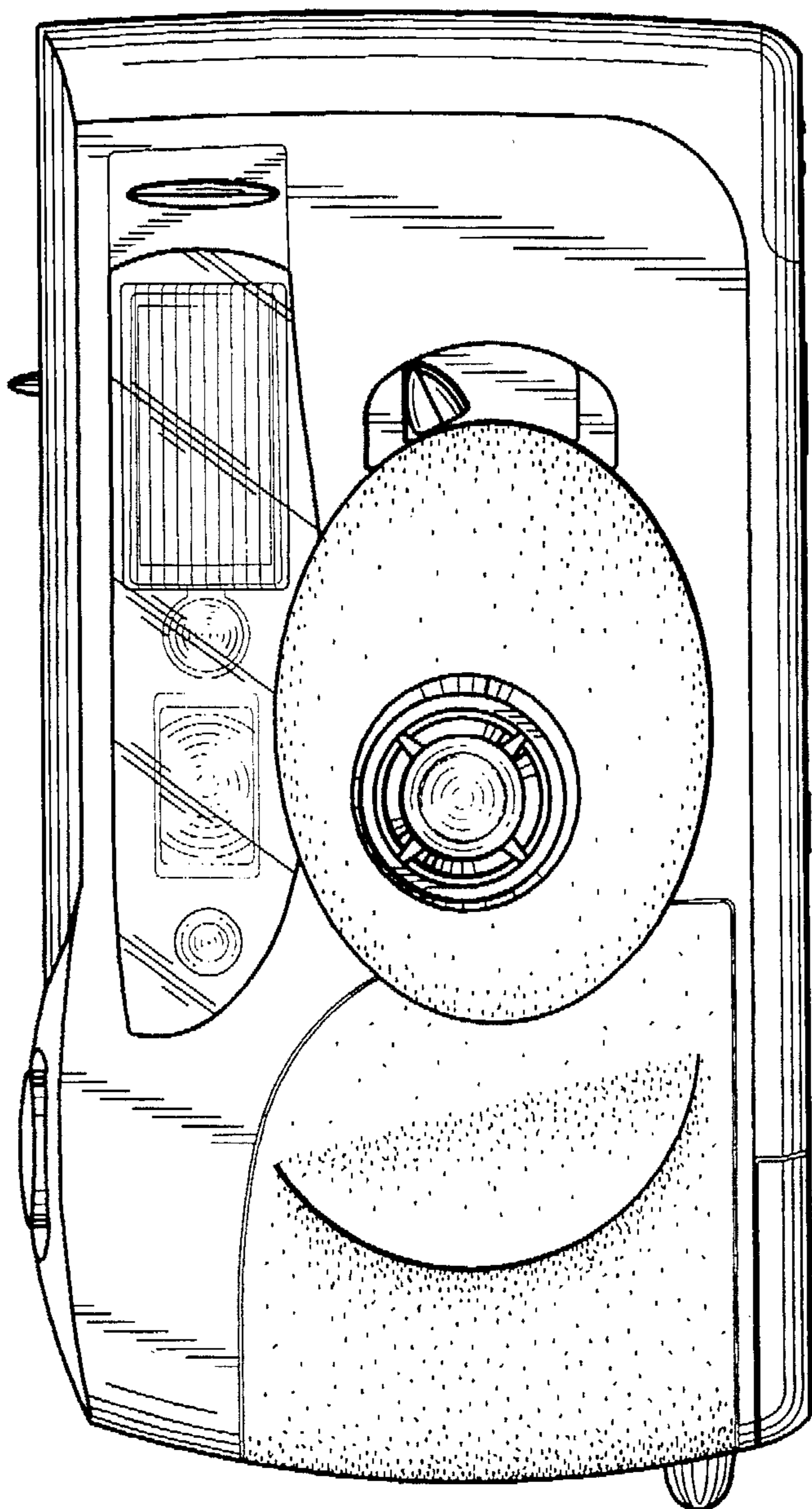

FIG. 3

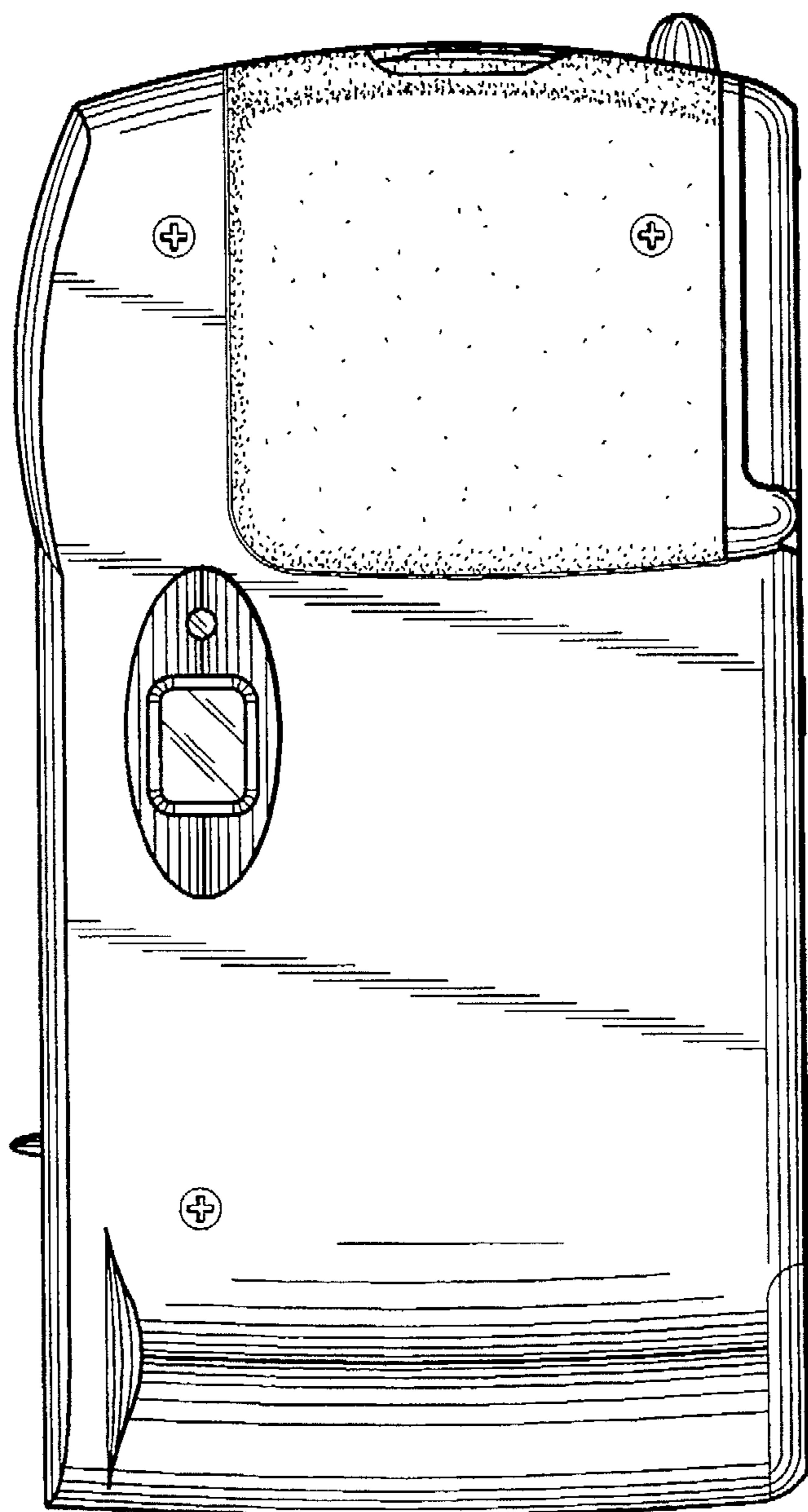
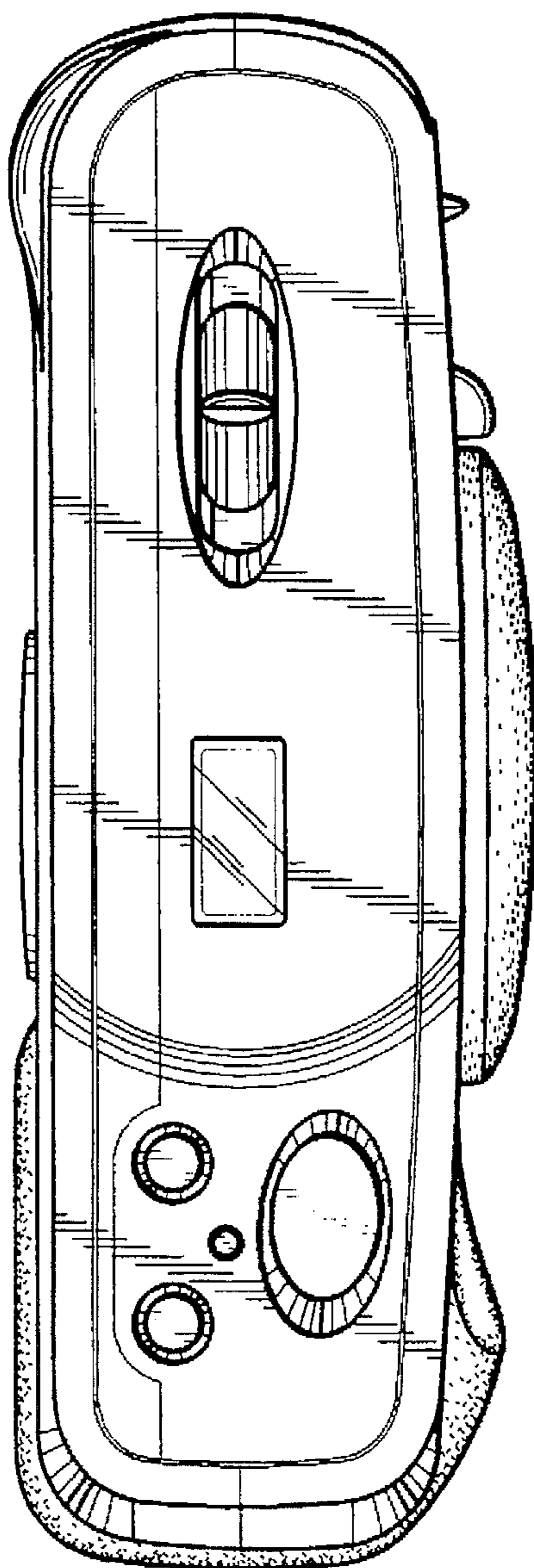

FIG. 4



**FIG. 5**

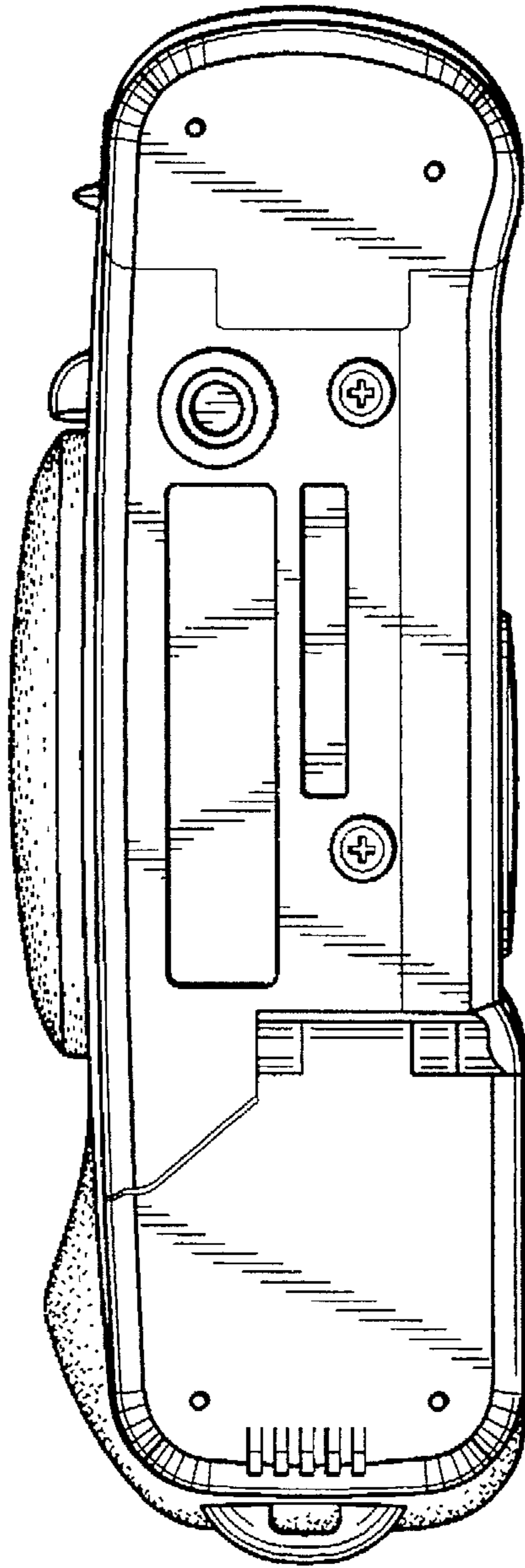

FIG. 6

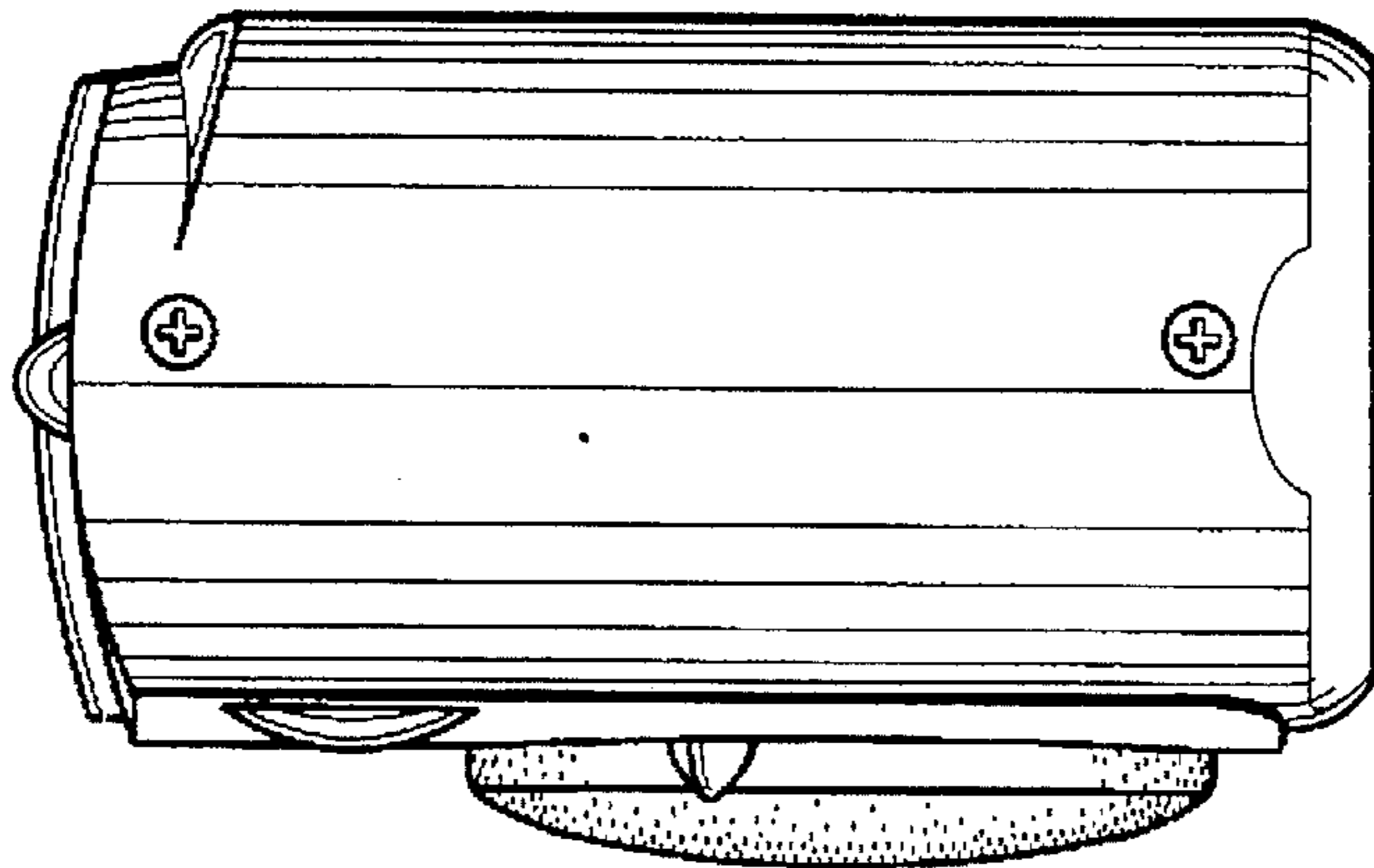
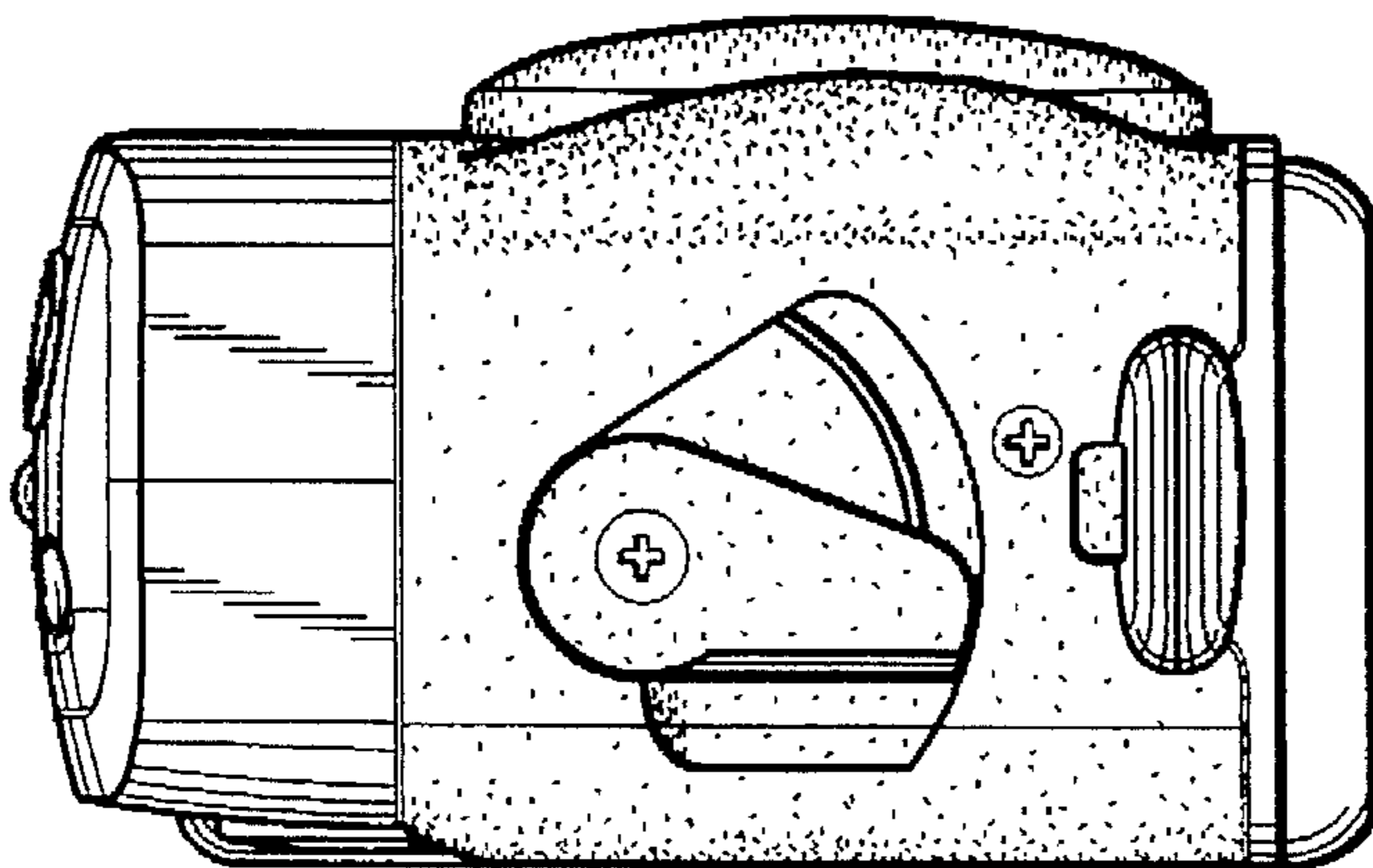

FIG. 7





**FIG. 8**

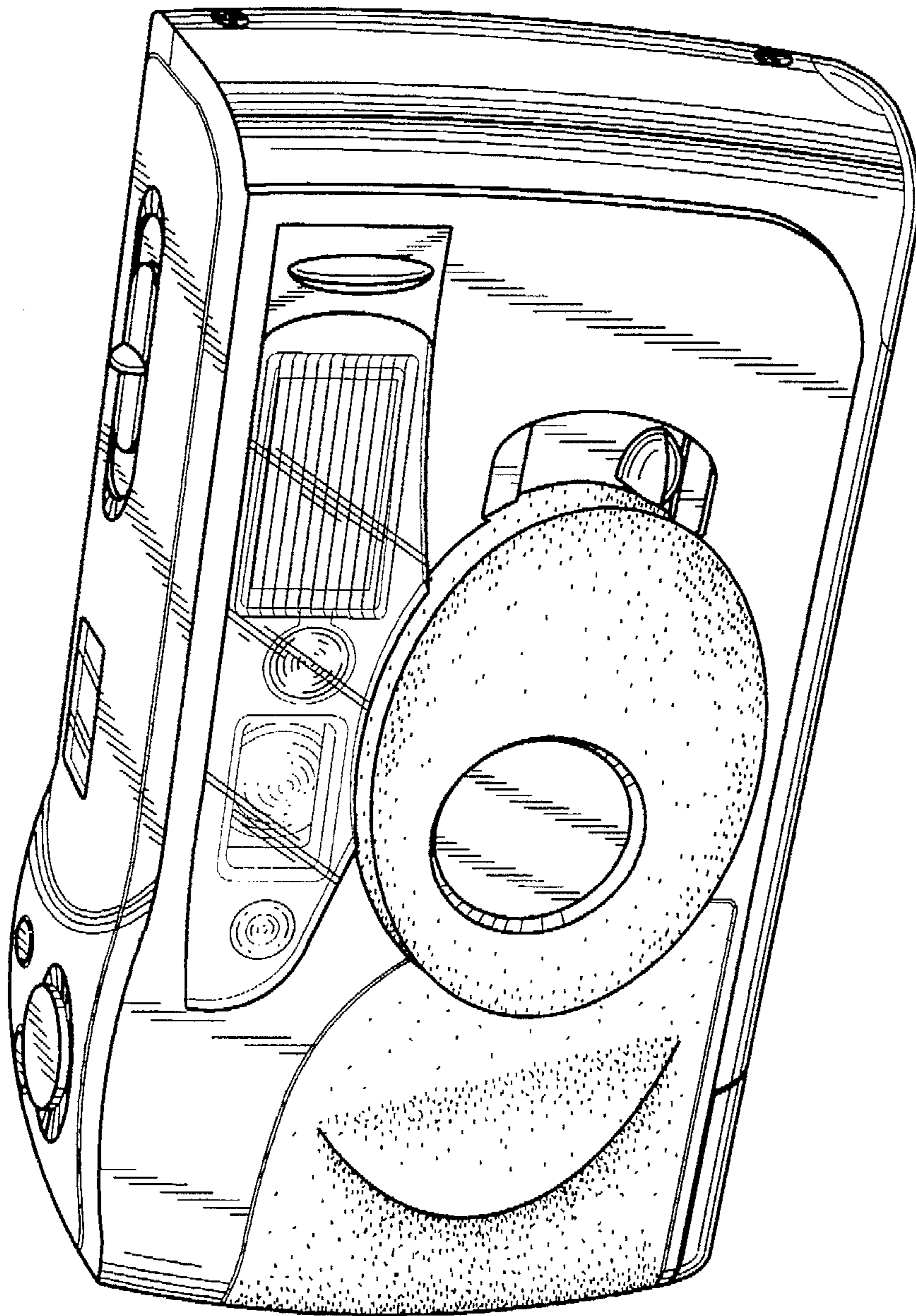
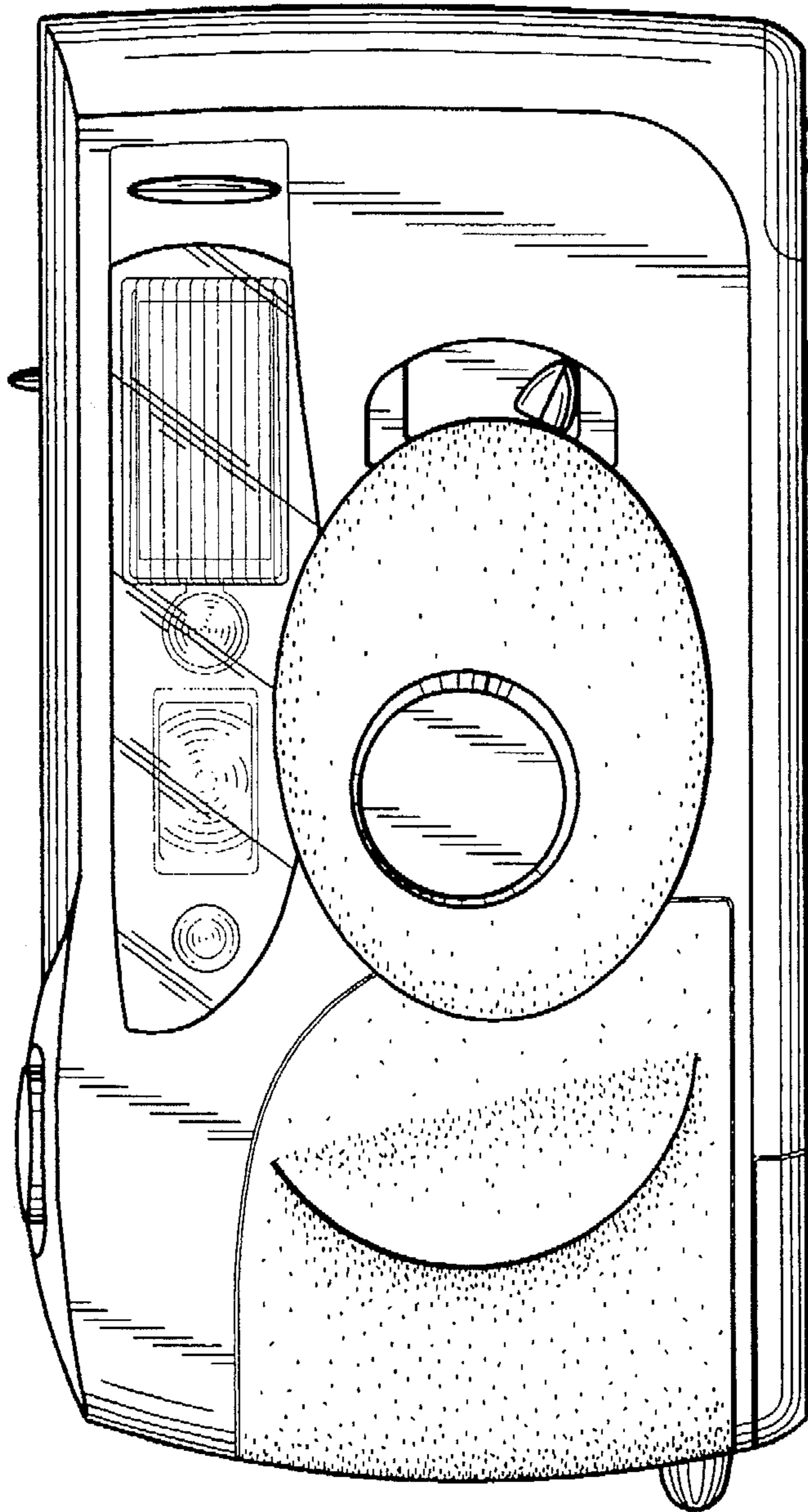
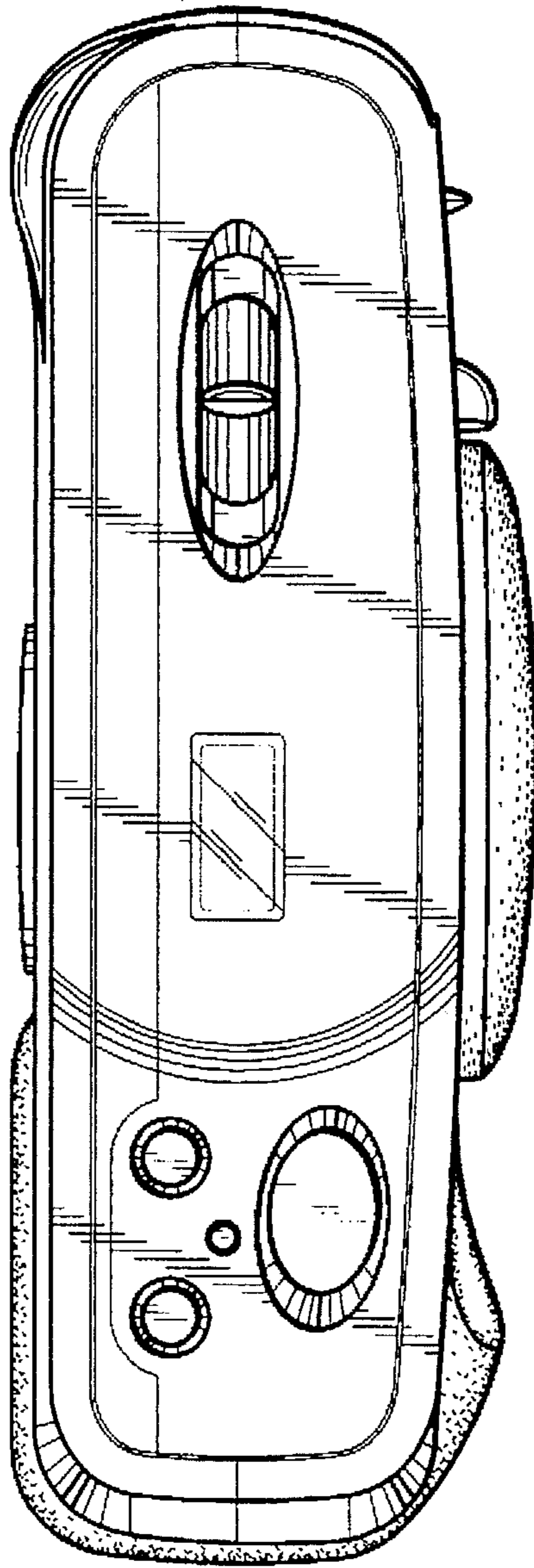

FIG. 9



**FIG. 10**



**FIG. 11**

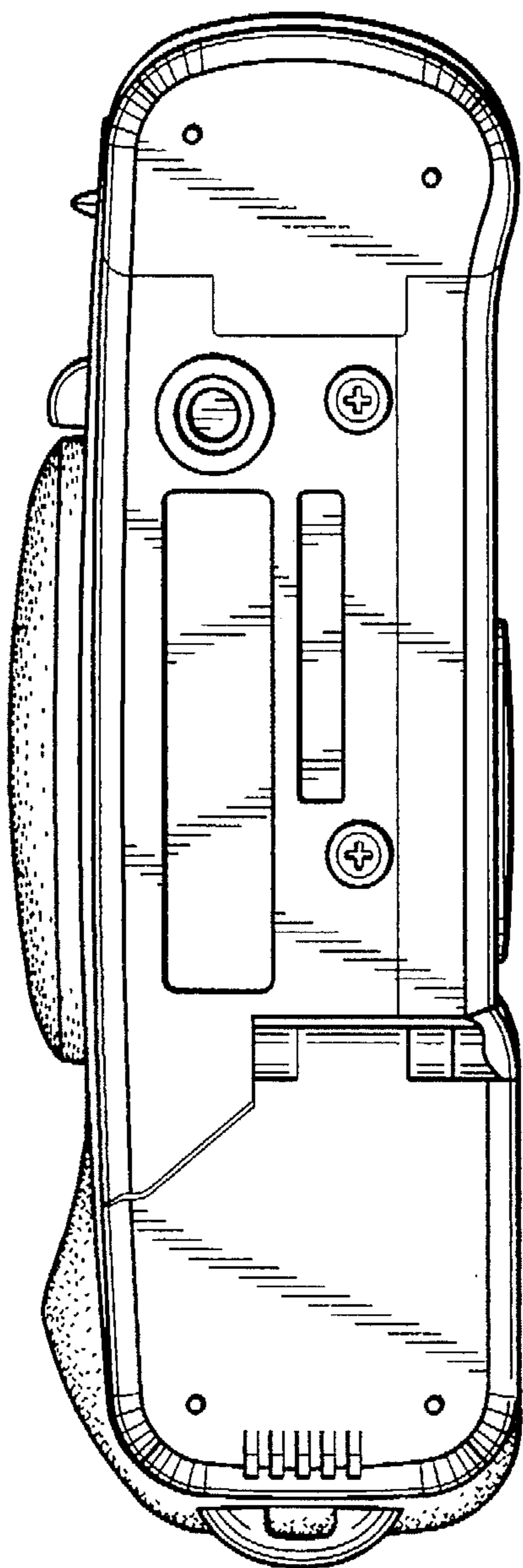

**FIG. 12**

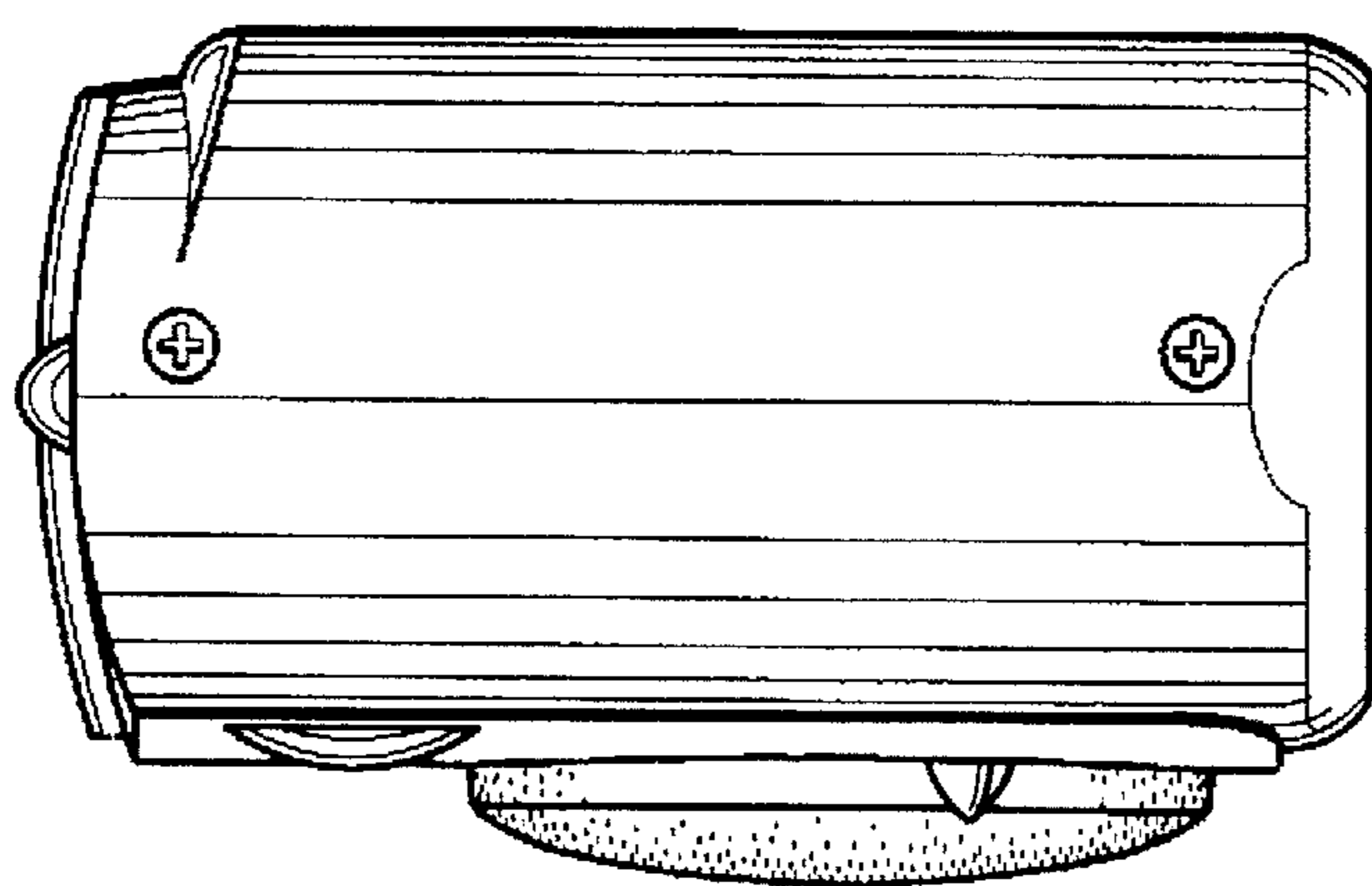

**FIG. 13**