



US00D379880S

United States Patent [19]

Stoekli et al.

[11] Patent Number: **Des. 379,880**

[45] Date of Patent: ****Jun. 17, 1997**

[54] CABINET WITH SLIDING DRAWERS

[75] Inventors: **Kaspar Stoekli, Kiesen; Florin Baeriswyl, Zürich, both of Switzerland**

[73] Assignee: **USM U. Scharer Sohne AG., Munsingen, Switzerland**

[**] Term: **14 Years**

[21] Appl. No.: **37,793**

[22] Filed: **Apr. 20, 1995**

[30] Foreign Application Priority Data

Nov. 2, 1994 [CH] Switzerland 121-763

[51] LOC (6) Cl. **06-04**

[52] U.S. Cl. **D6/446**

[58] Field of Search D6/432-448; D19/92; 211/126, 11, 151; 312/189, 111, 188, 107

[56] References Cited

U.S. PATENT DOCUMENTS

D. 179,480	1/1957	Jones et al.	D6/446
D. 230,646	3/1974	Unger	D19/92
D. 286,714	11/1986	Verholt	D6/446
D. 287,080	12/1986	Densen	D6/446
D. 296,505	7/1988	Kaliski et al.	D6/446
D. 323,082	1/1992	Rones	D6/446
D. 332,880	2/1993	Cugley et al.	D6/446

OTHER PUBLICATIONS

Multi-form Office Supplies, p. 3.12; multidrawer system on center of page #030107, 030207, 03030707 and 03040707.

Primary Examiner—Carmen H. Vales-Lado

[57] CLAIM

The ornamental design for a cabinet with sliding drawers, as shown and described.

DESCRIPTION

FIG. 1 is a left side elevational view of a cabinet with sliding drawers, showing our new design;

FIG. 2 is a right side elevational view thereof;
 FIG. 3 is a top plan view thereof;
 FIG. 4 is a bottom plan view thereof;
 FIG. 5 is a front elevational view thereof;
 FIG. 6 is a rear elevational view thereof;
 FIG. 7 is a perspective view showing the left side, top and front thereof;
 FIG. 8 is a top, rear perspective view of a drawer of FIG. 1, the cabinet removed for convenience of illustration;
 FIG. 9 is a left side, top and front perspective view of a second embodiment of the cabinet with sliding drawers shown in FIG. 1;
 FIG. 10 is a front elevational view thereof;
 FIG. 11 is a rear elevational view thereof;
 FIG. 12 is a left side elevational view thereof;
 FIG. 13 is a right side elevational view thereof;
 FIG. 14 is a top plan view thereof;
 FIG. 15 is a bottom plan view thereof;
 FIG. 16 is a top, front perspective view of a drawer of FIG. 9, the cabinet removed for convenience of illustration;
 FIG. 17 is a left side, top and front perspective view of a third embodiment of the cabinet with sliding drawers shown in FIG. 1;
 FIG. 18 is a front elevational view thereof;
 FIG. 19 is a rear elevational view thereof;
 FIG. 20 is a left side elevational view thereof;
 FIG. 21 is a right side elevational view thereof;
 FIG. 22 is a top plan view thereof;
 FIG. 23 is a bottom plan view thereof;
 FIG. 24 is a top, rear perspective view of a drawer of FIG. 17, the cabinet removed for convenience of illustration;
 FIG. 25 is a left side, top and front perspective view of a fourth embodiment of the cabinet with sliding drawers shown in FIG. 1;
 FIG. 26 is a front elevational view thereof;
 FIG. 27 is a rear elevational view thereof;
 FIG. 28 is a left side elevational view thereof;
 FIG. 29 is a right side elevational view thereof;
 FIG. 30 is a top plan view thereof;
 FIG. 31 is a bottom plan view thereof; and,
 FIG. 32 is a top, front perspective view of a drawer of FIG. 25, the cabinet removed for convenience of illustration.

1 Claim, 8 Drawing Sheets

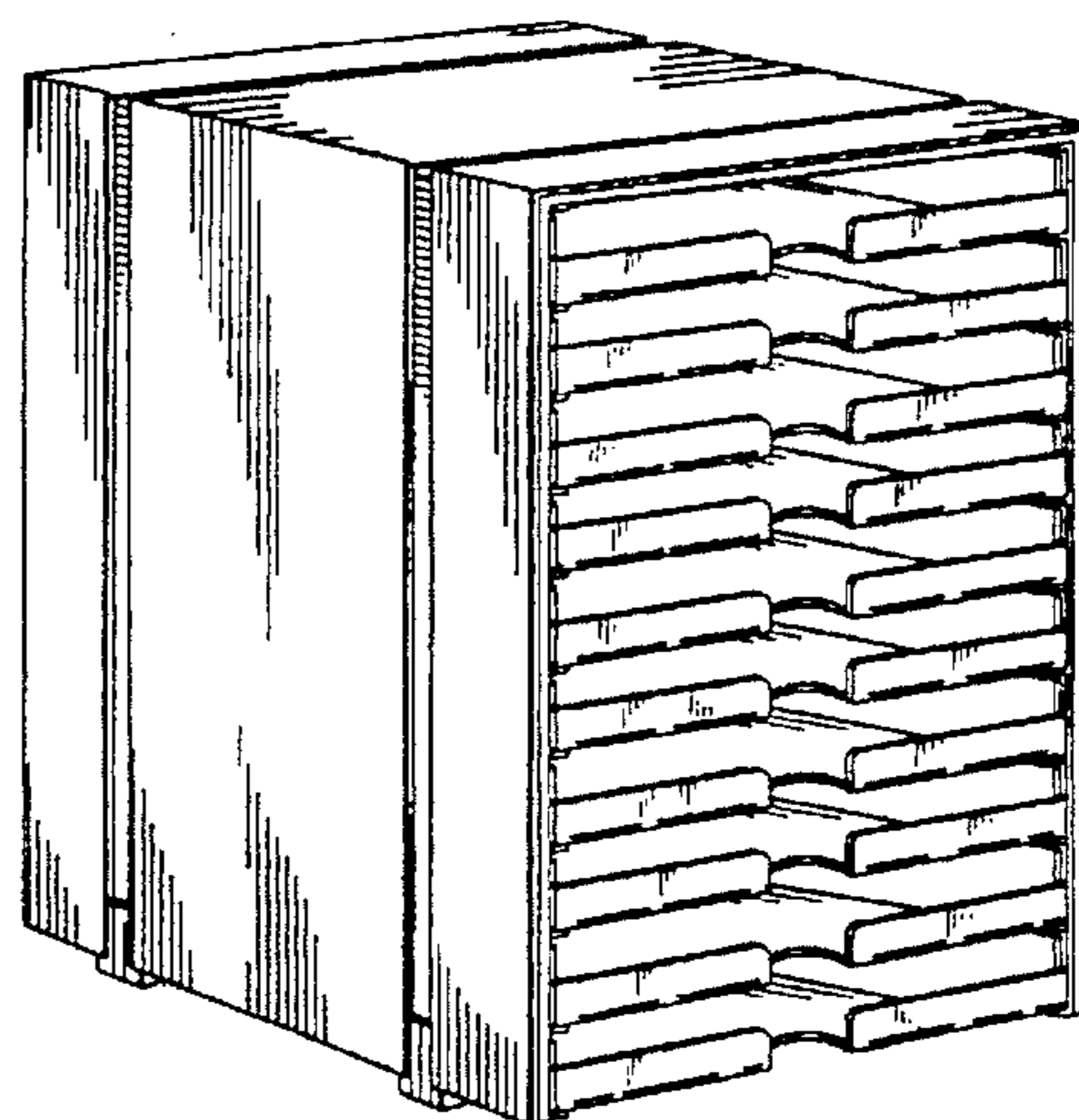
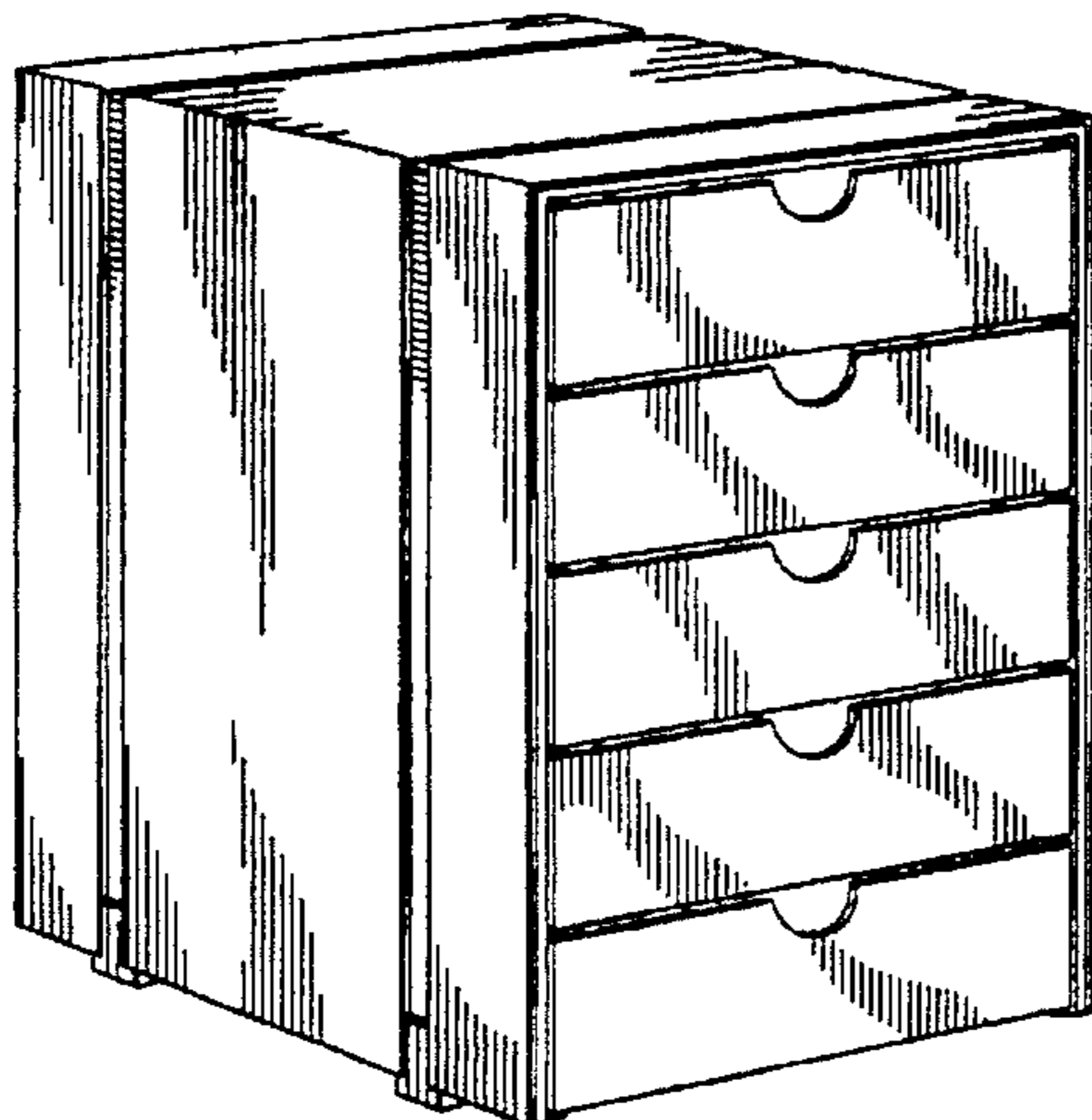

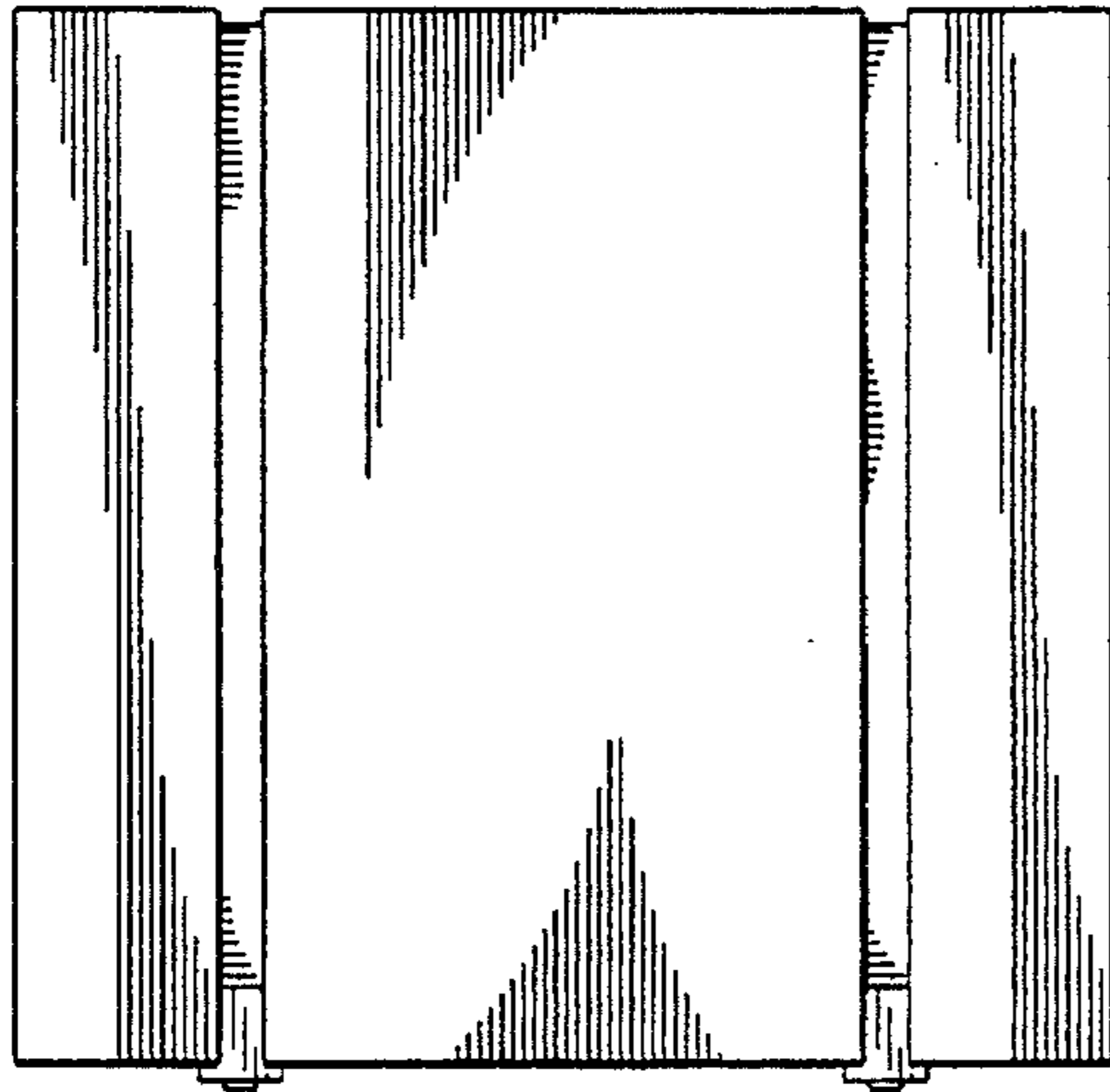

FIG. 1

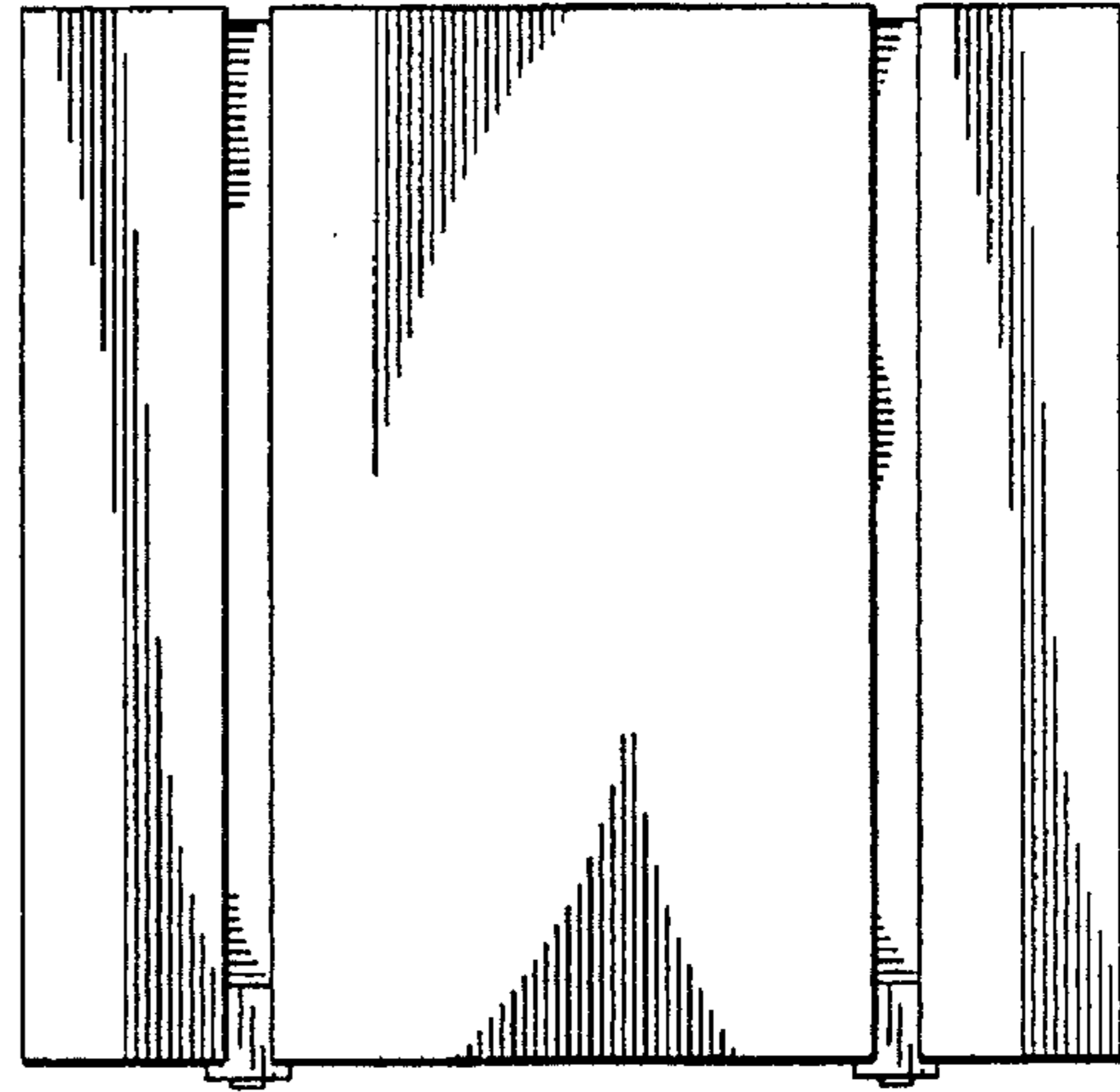

FIG. 2

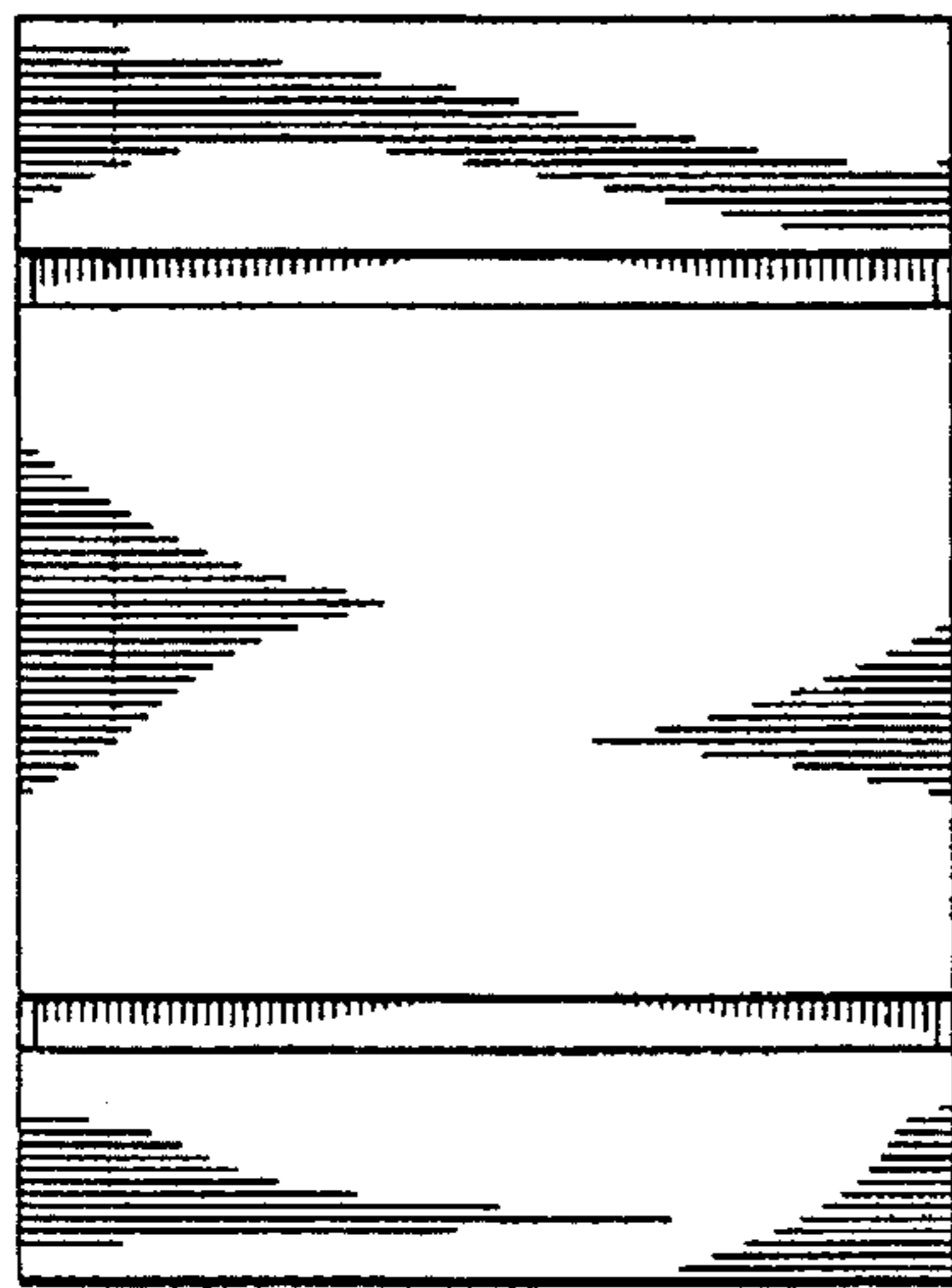

FIG. 3

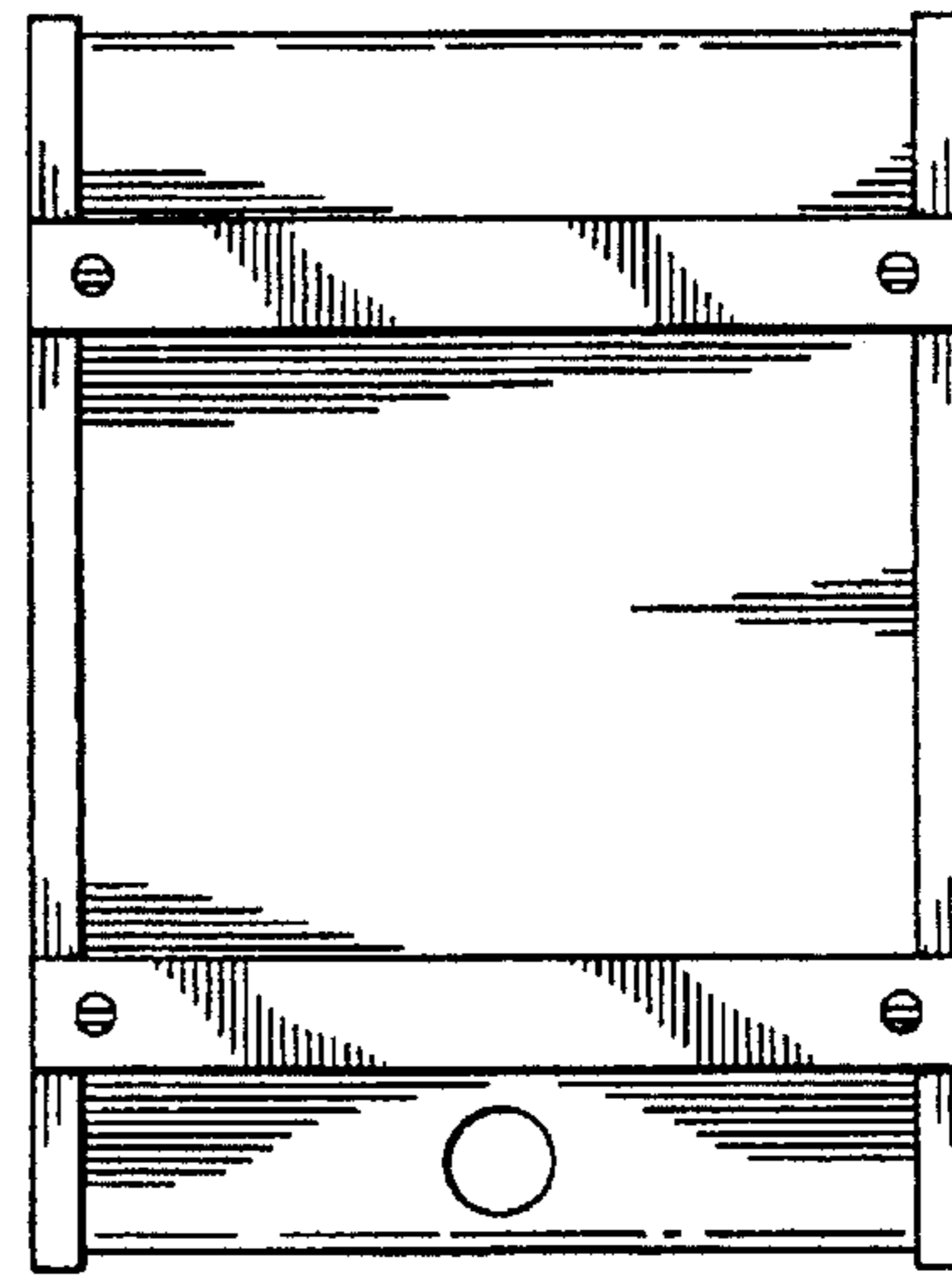

FIG. 4

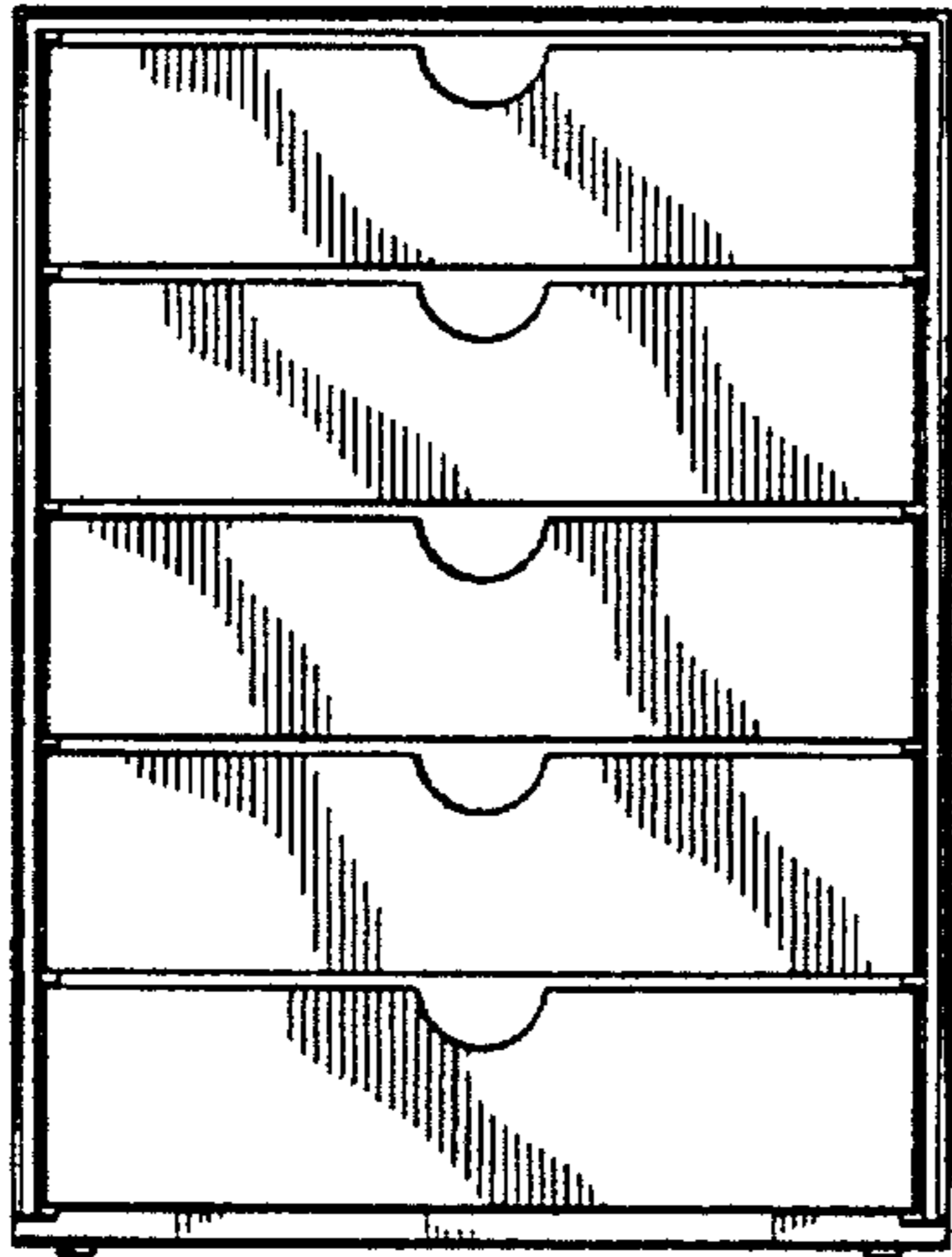

FIG. 5

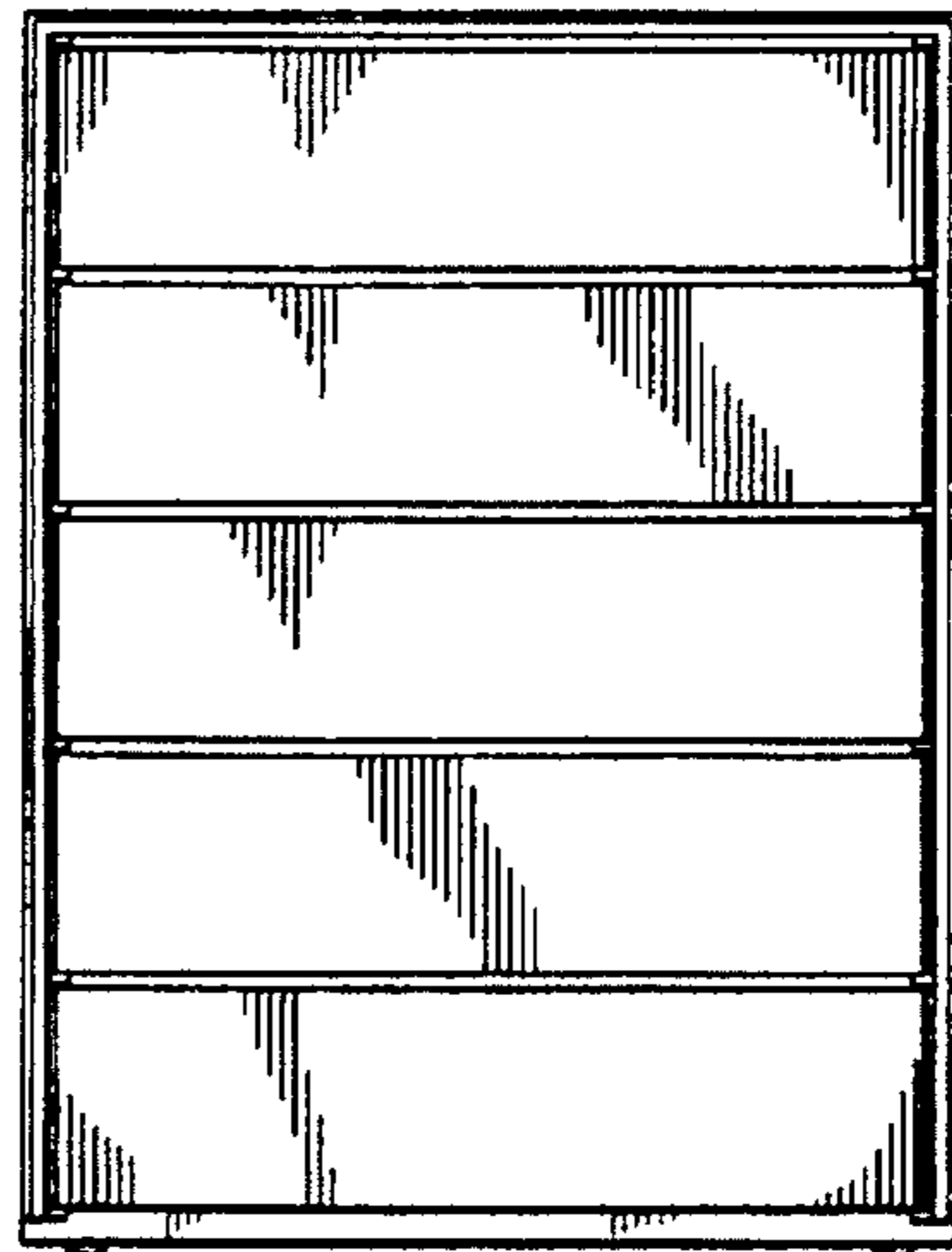

FIG. 6

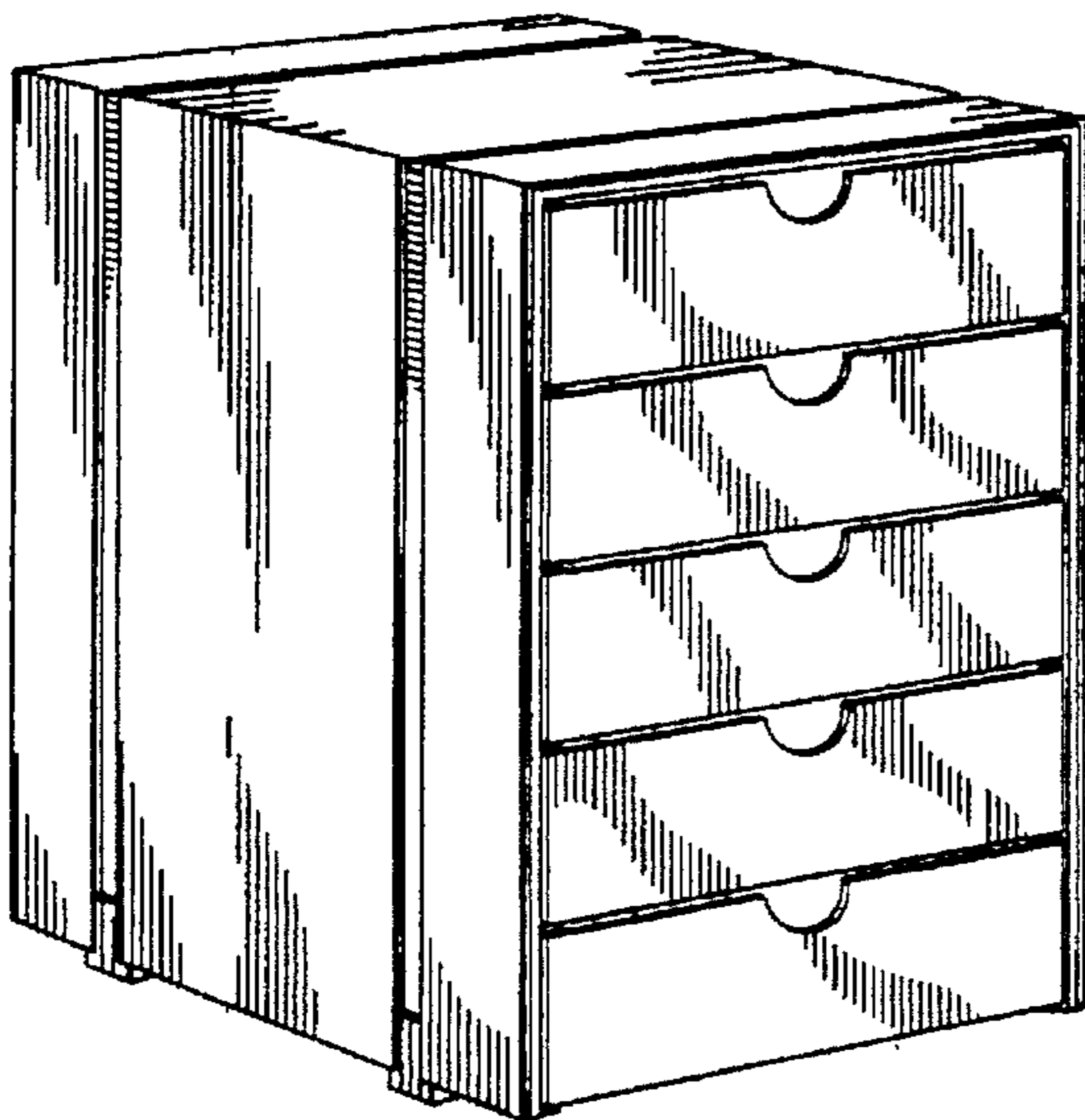

FIG. 7

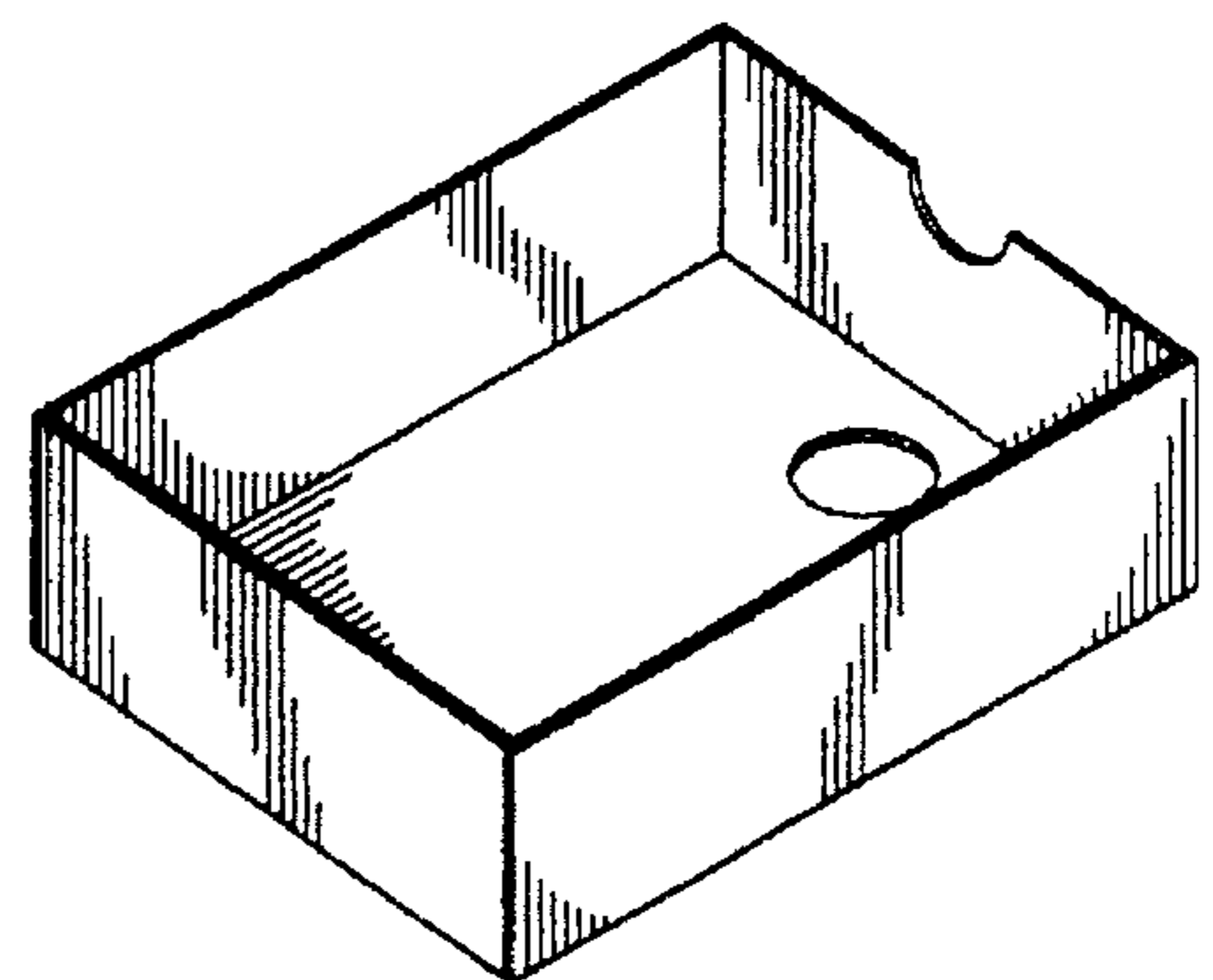

FIG. 8

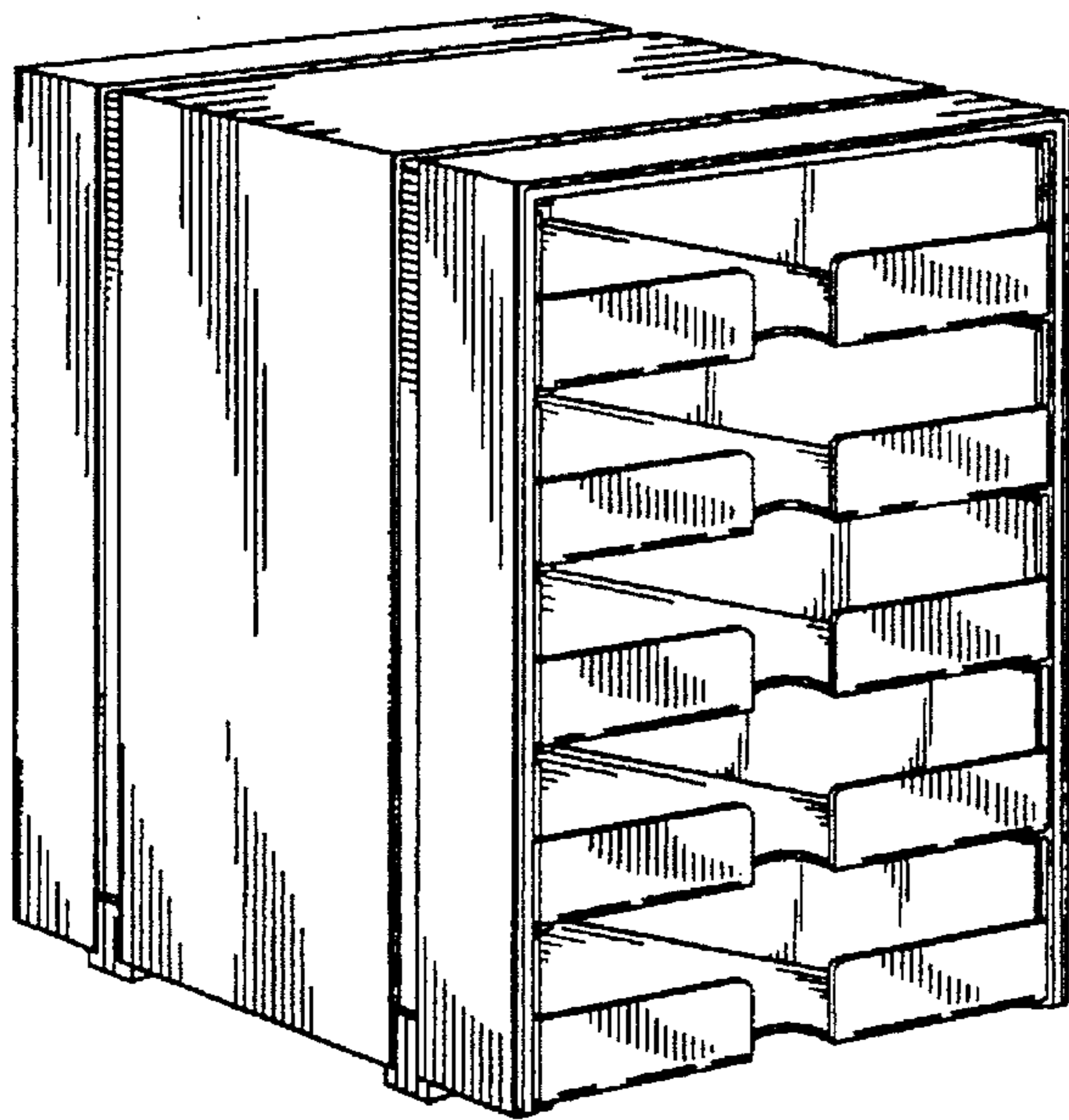

FIG. 9

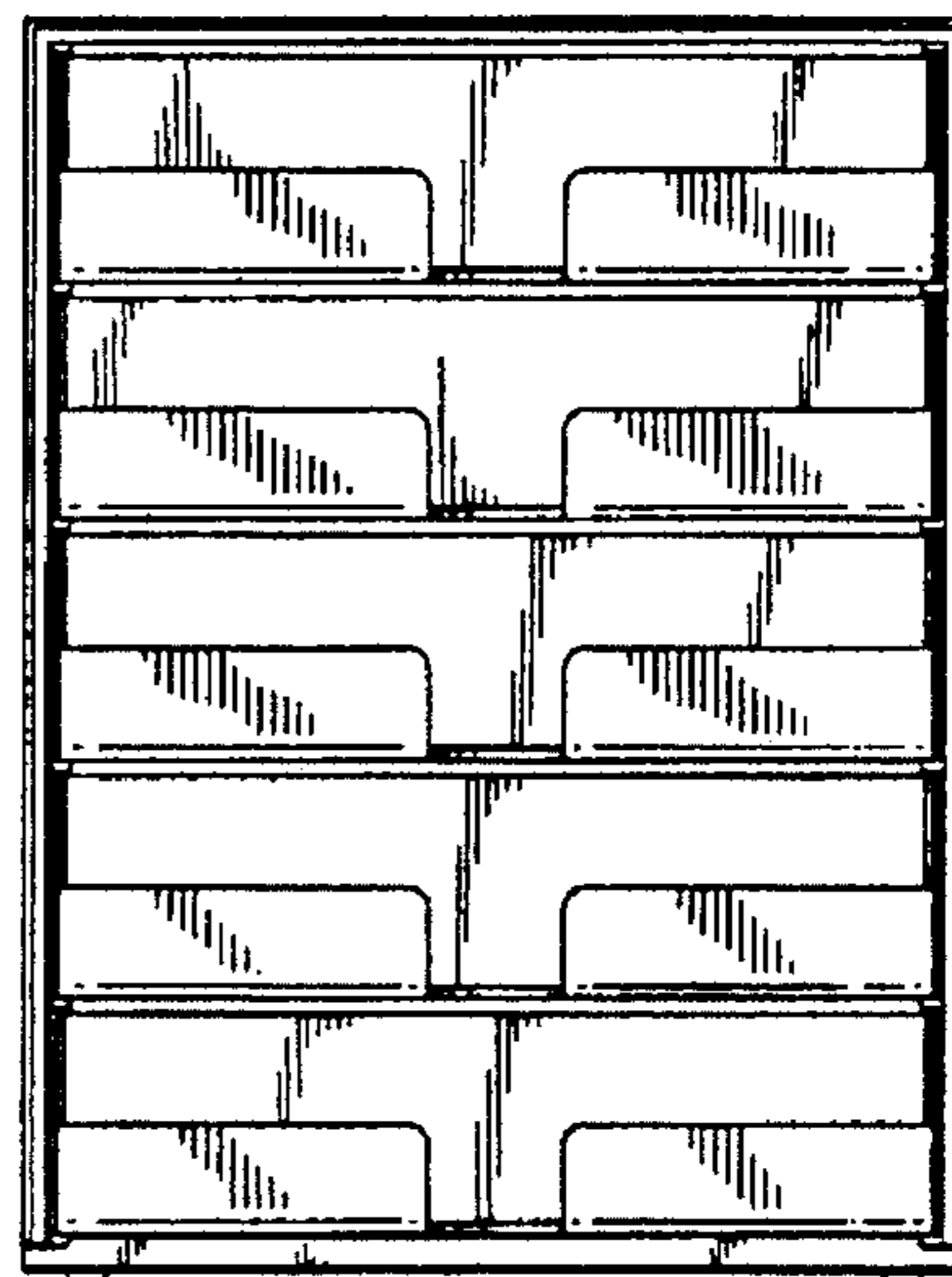

FIG. 10

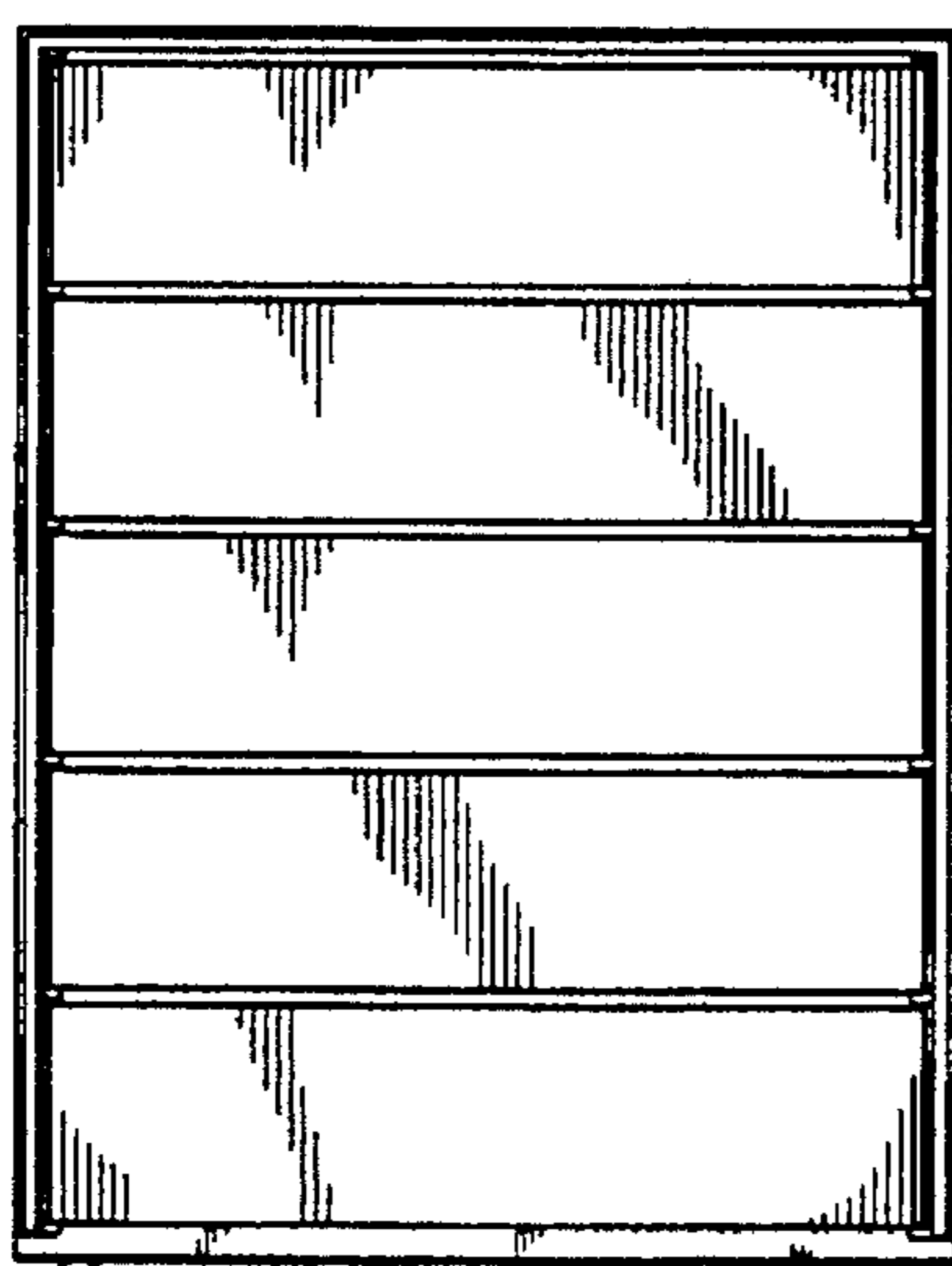

FIG. 11

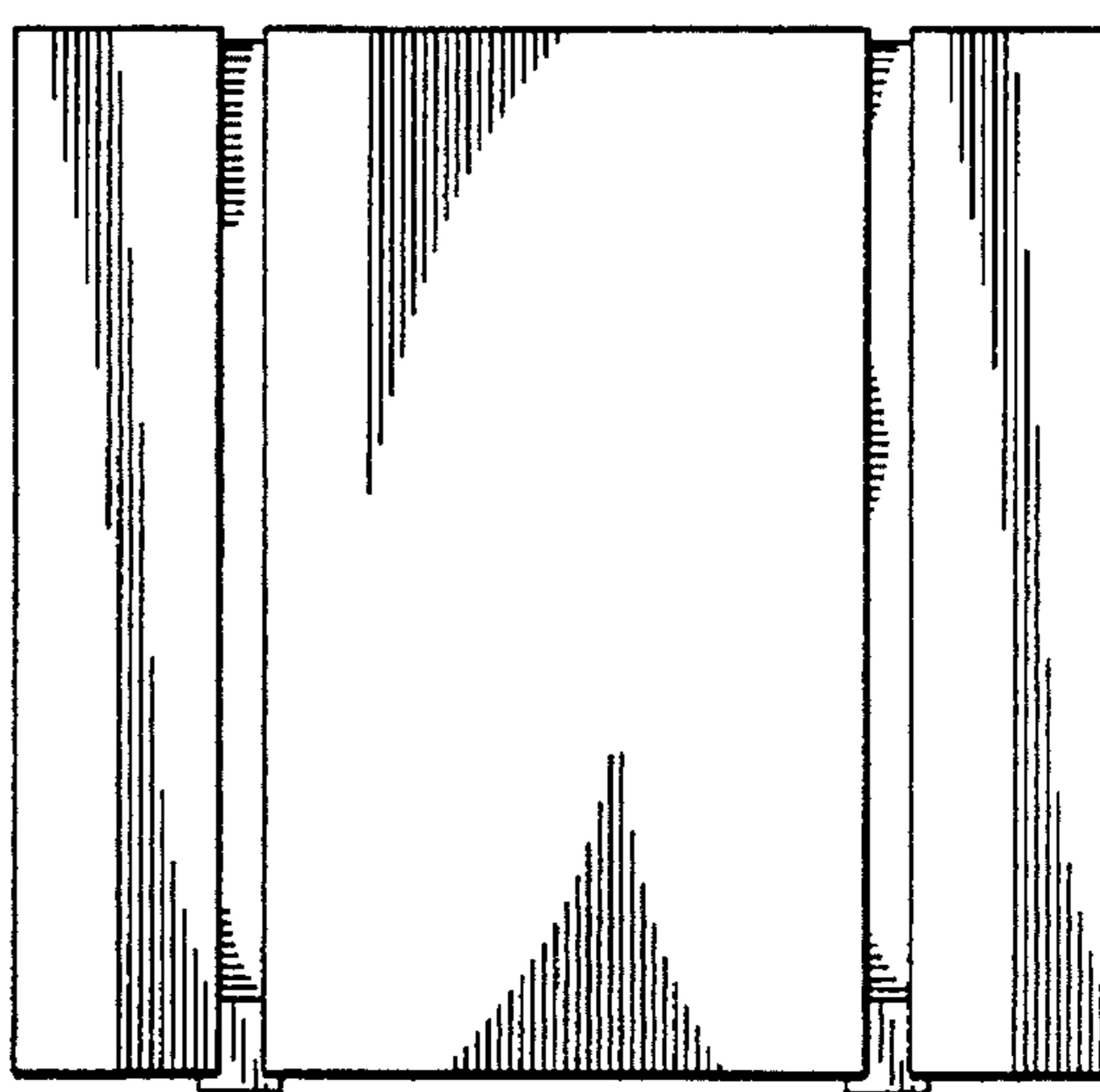

FIG. 12

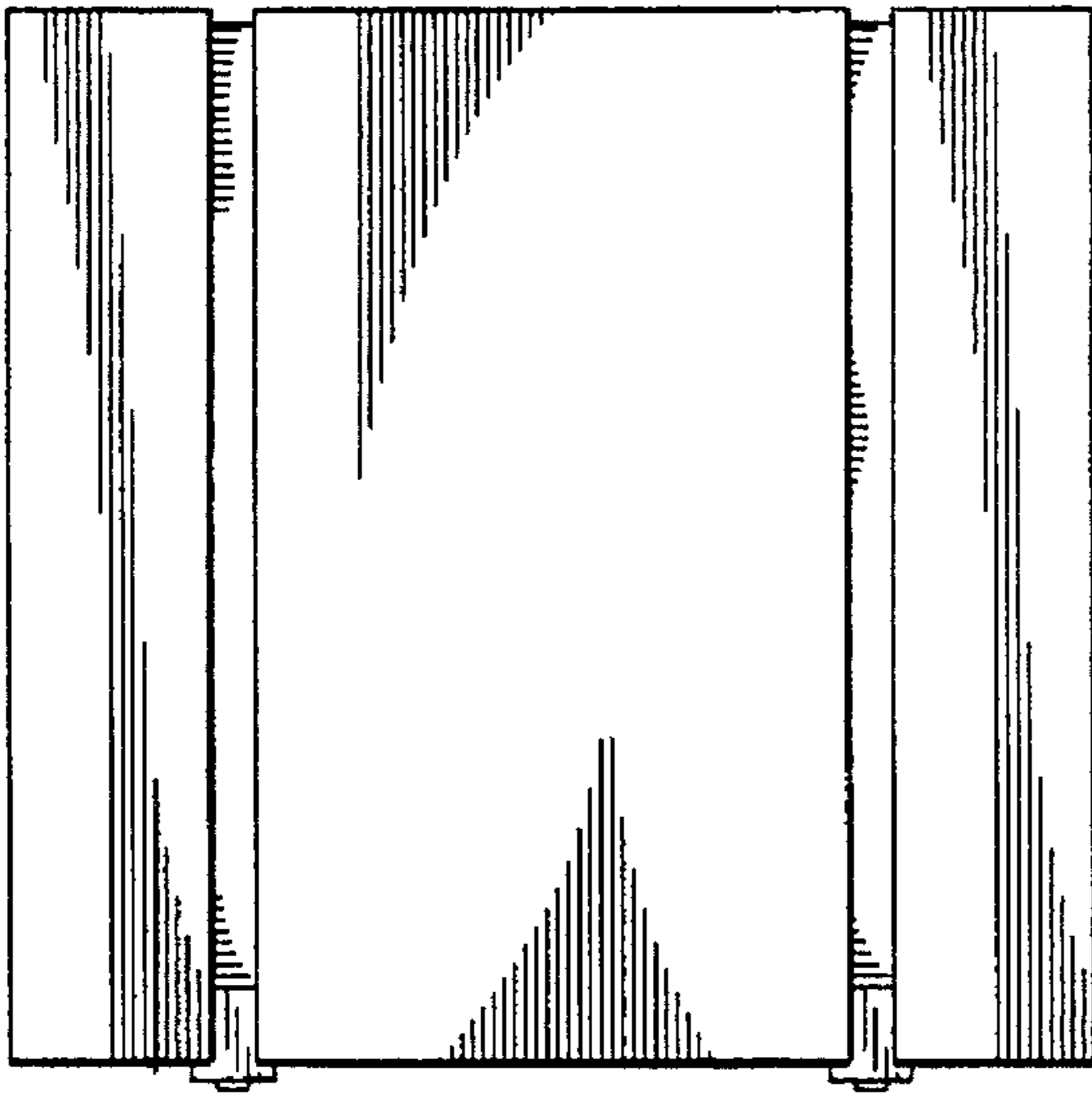

FIG. 13

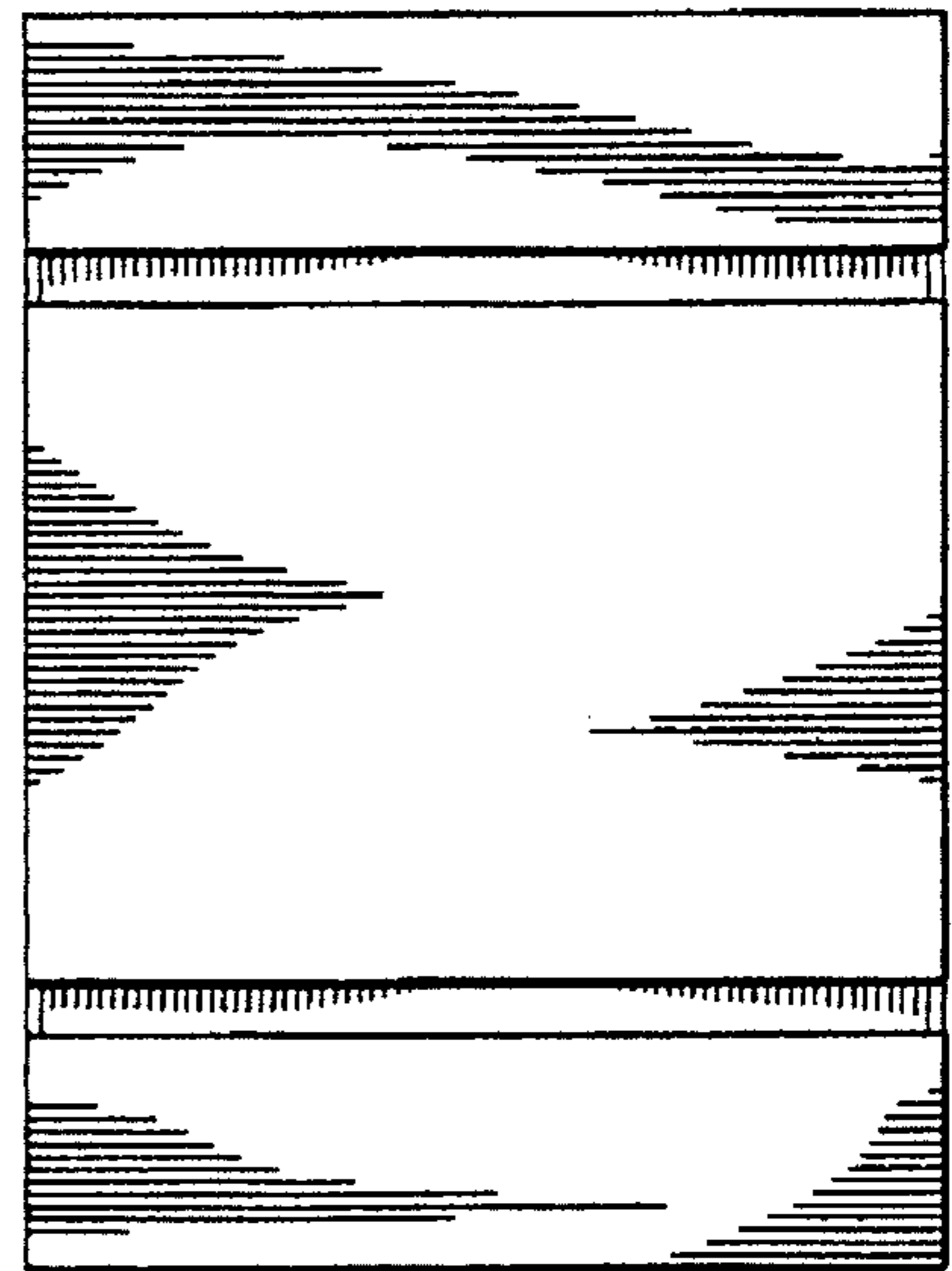

FIG. 14

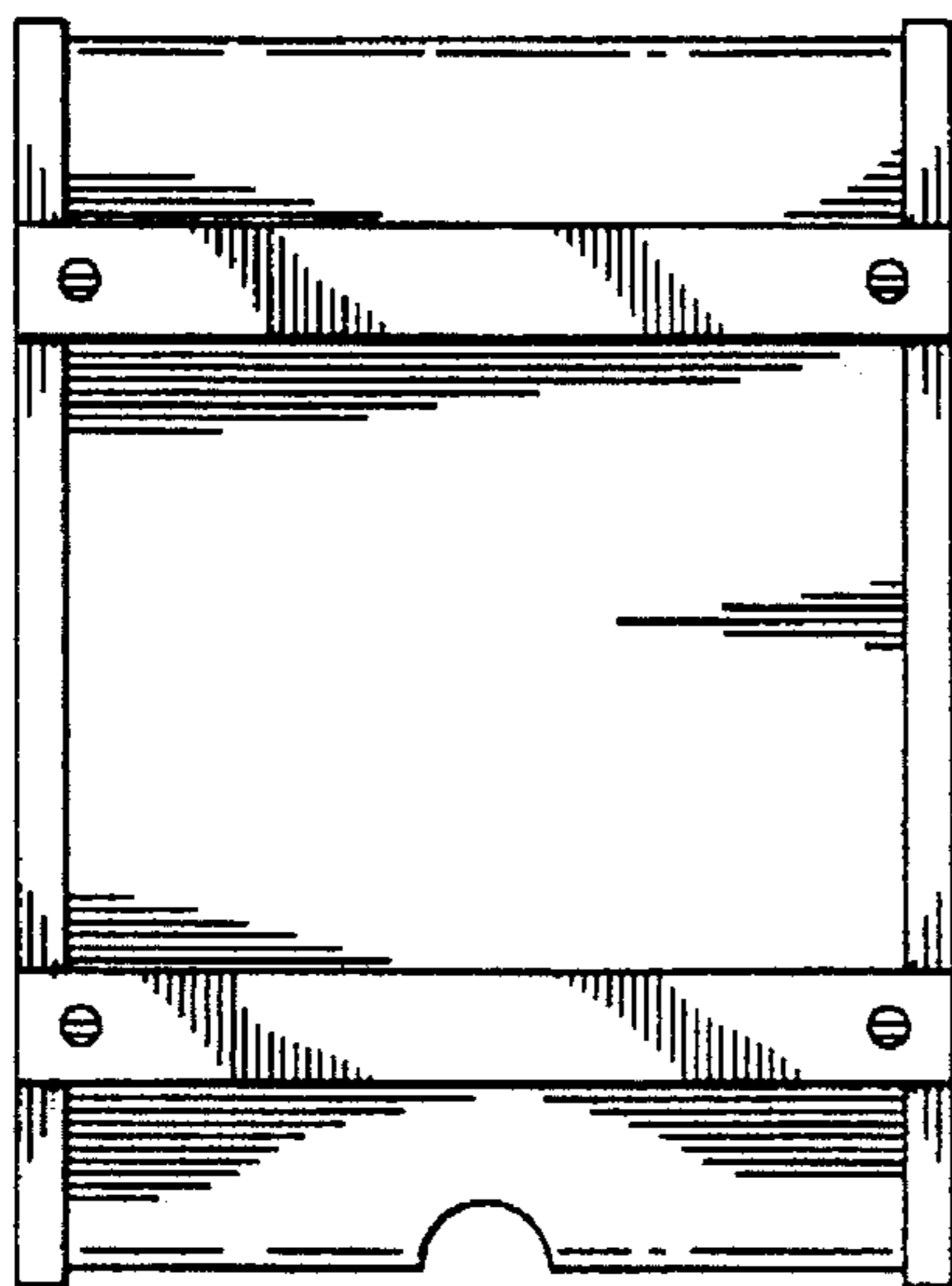

FIG. 15

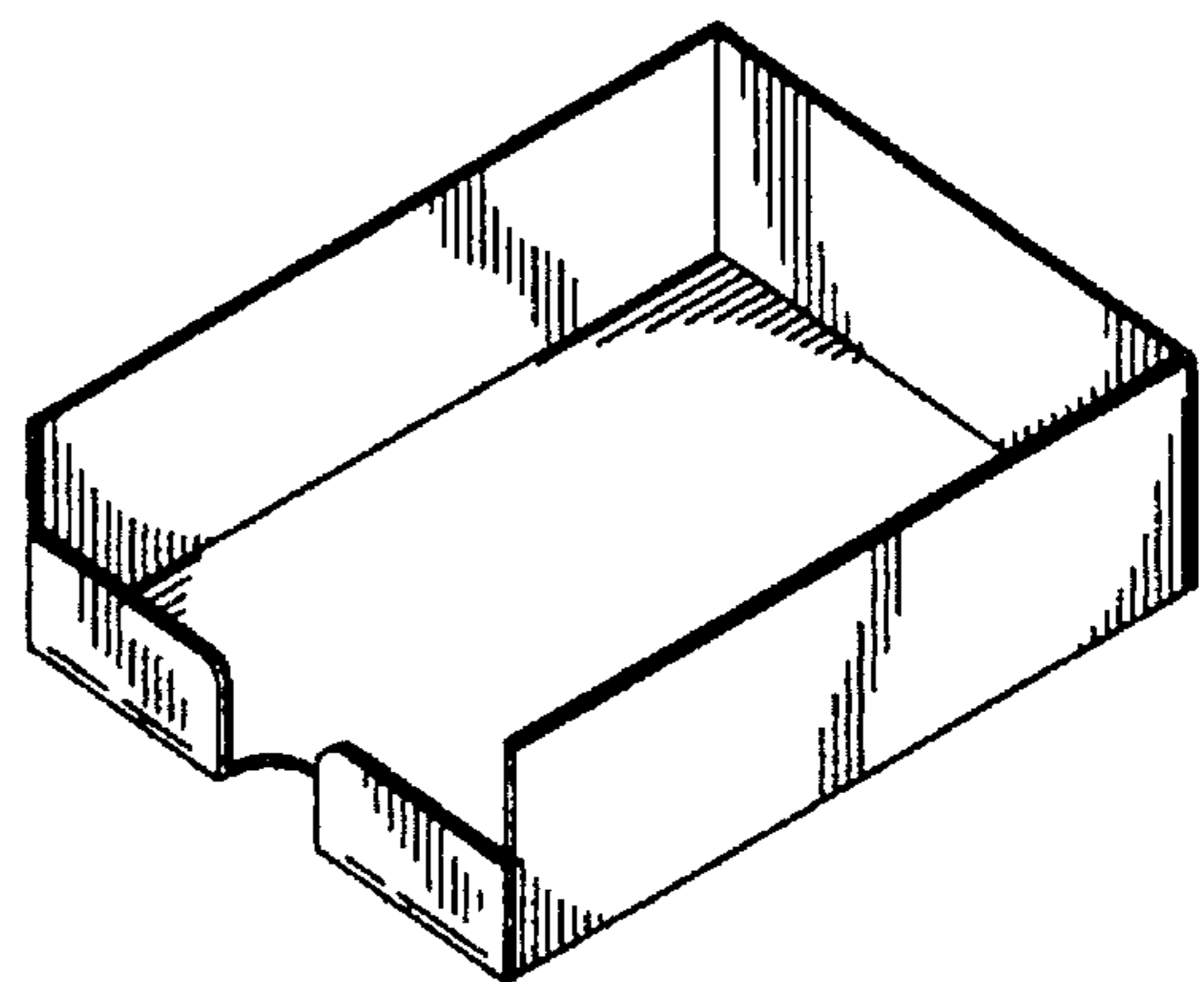

FIG. 16

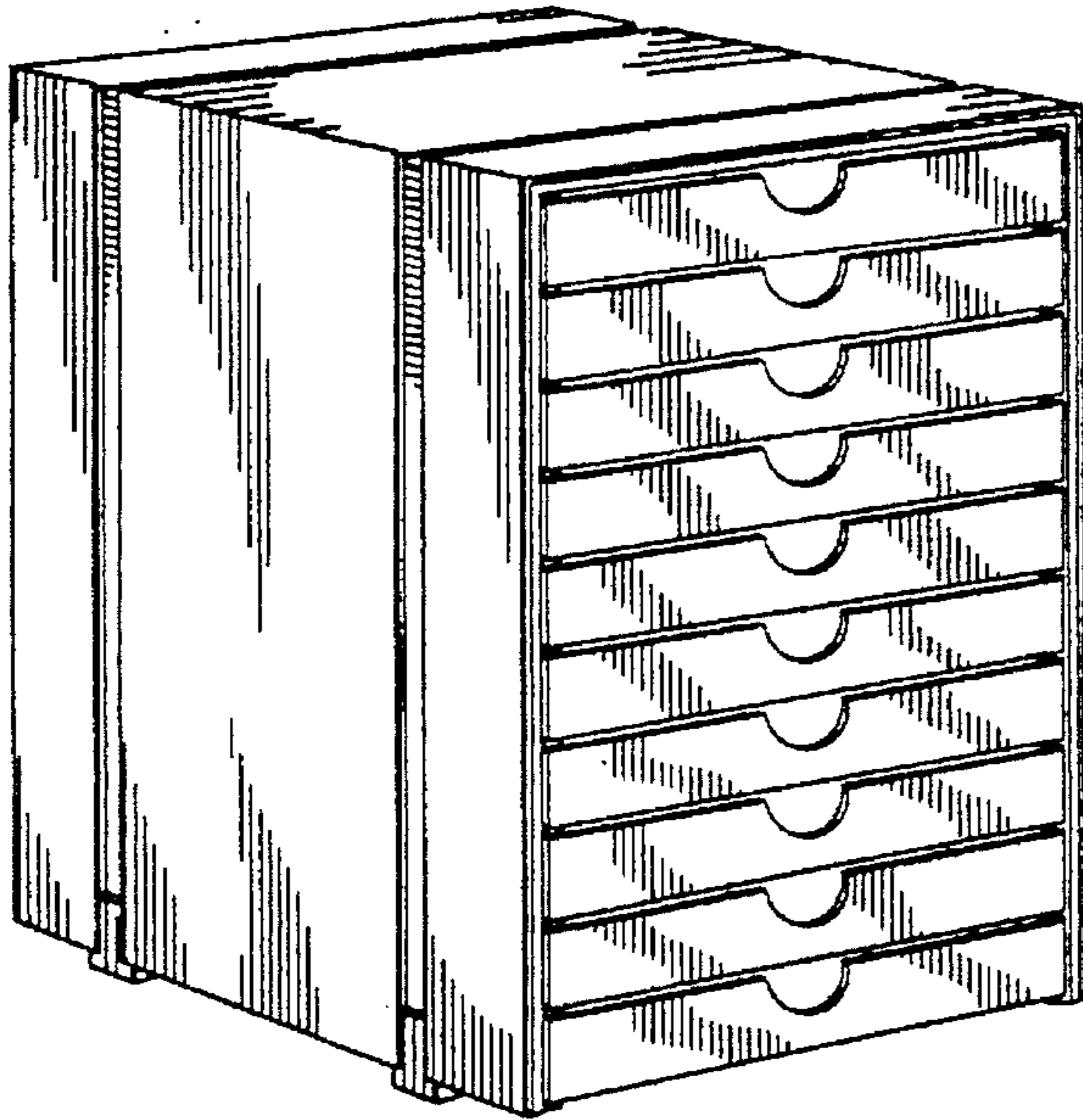

FIG. 17

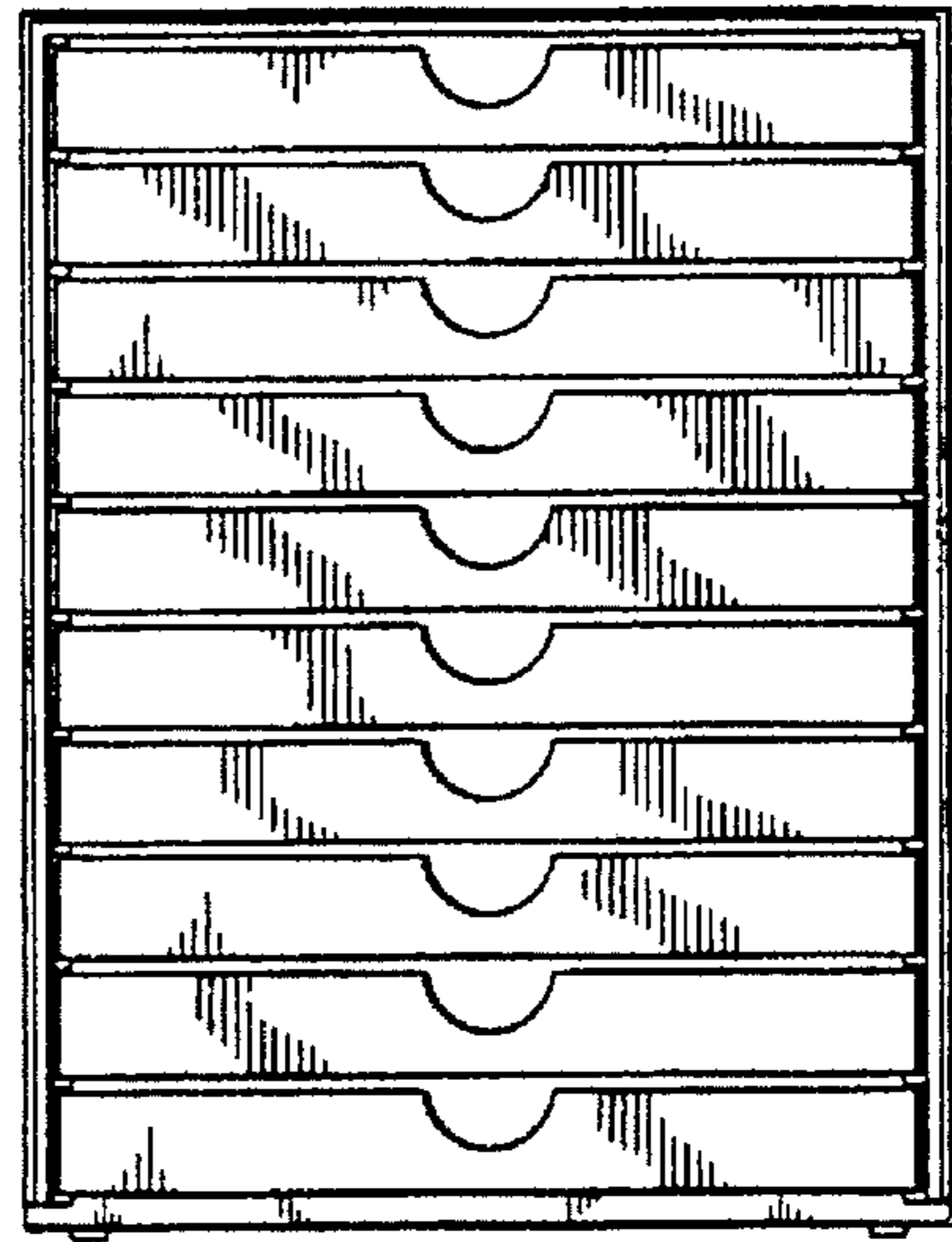

FIG. 18

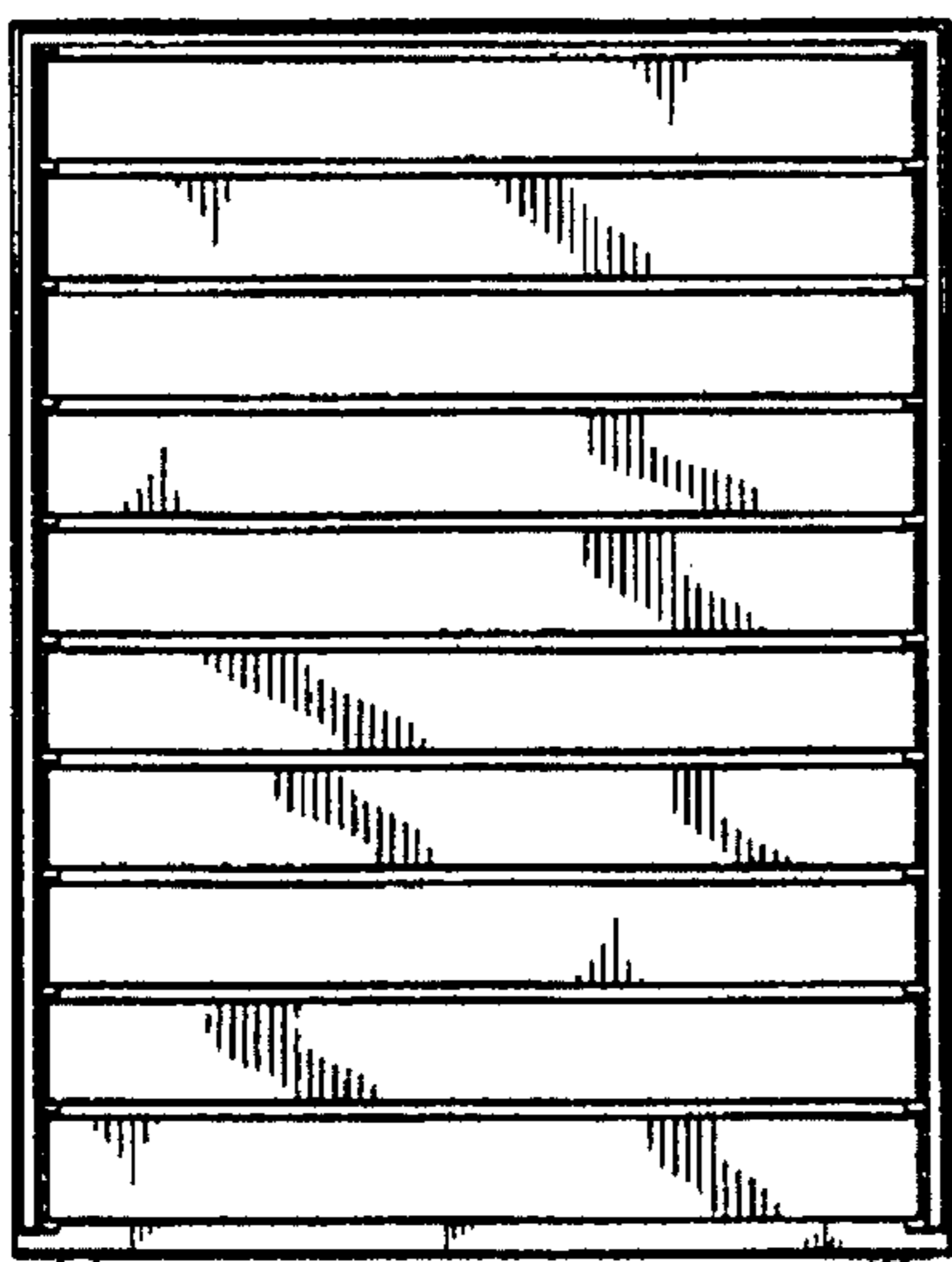

FIG. 19

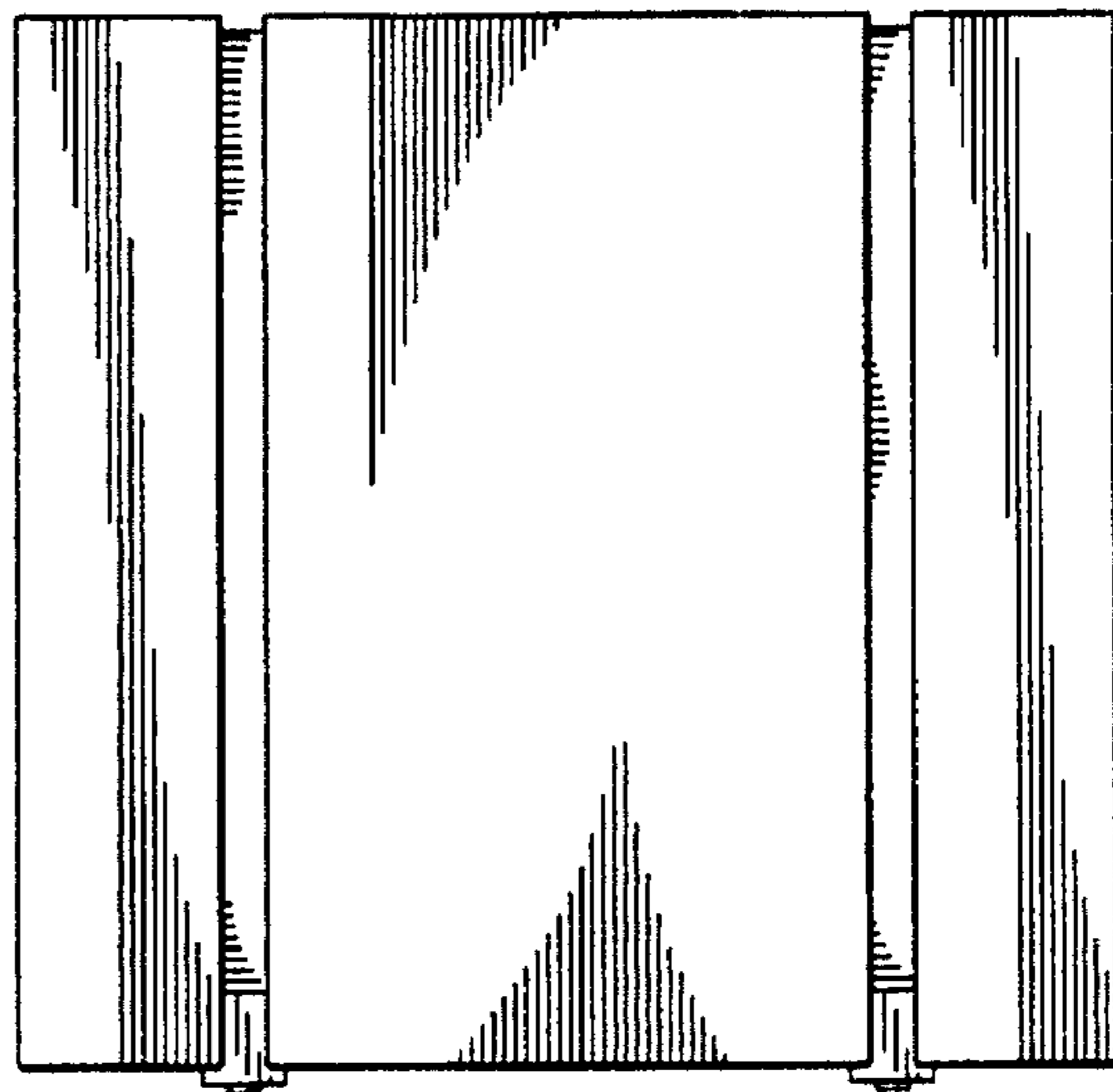

FIG. 20

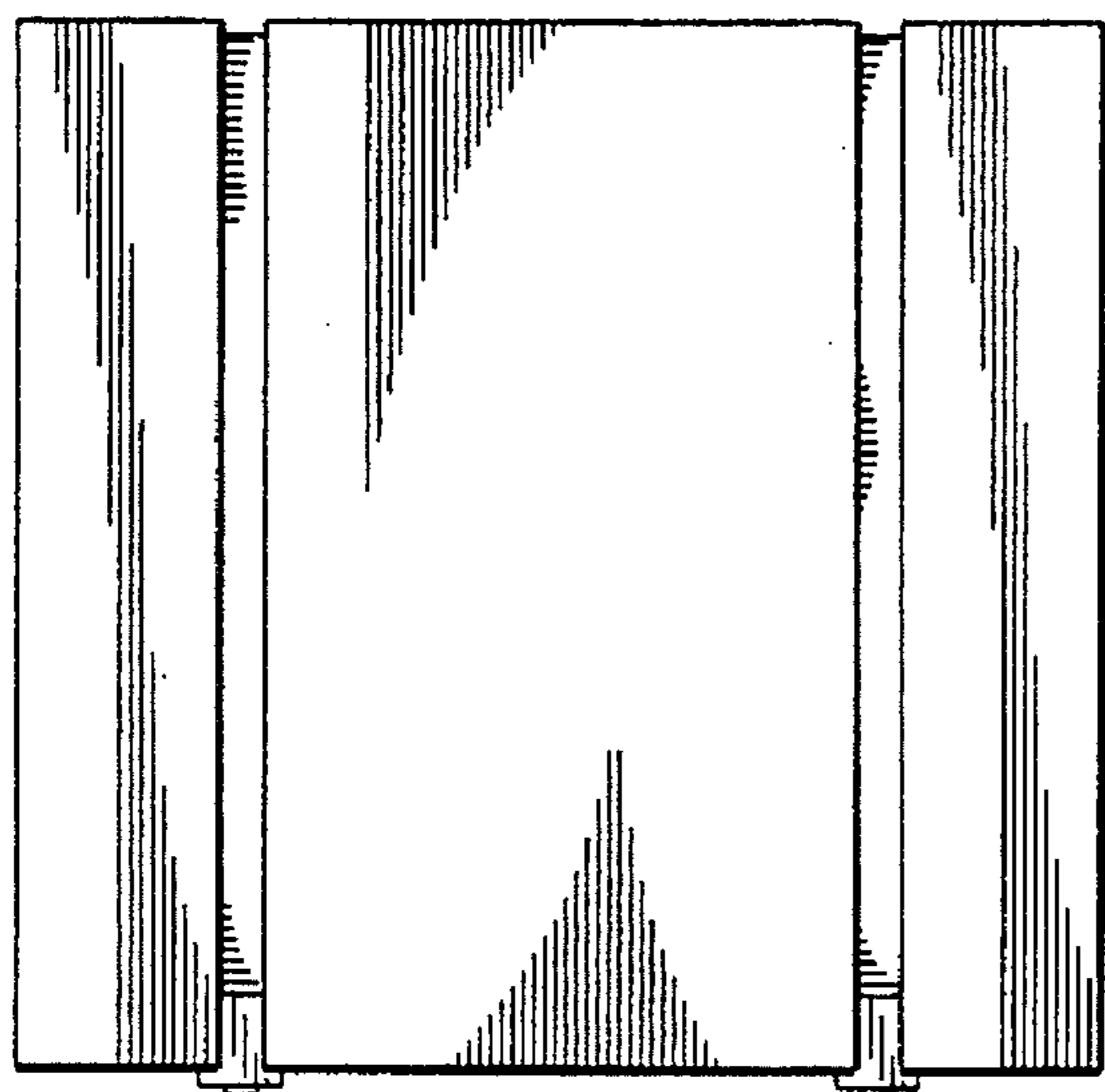

FIG. 21

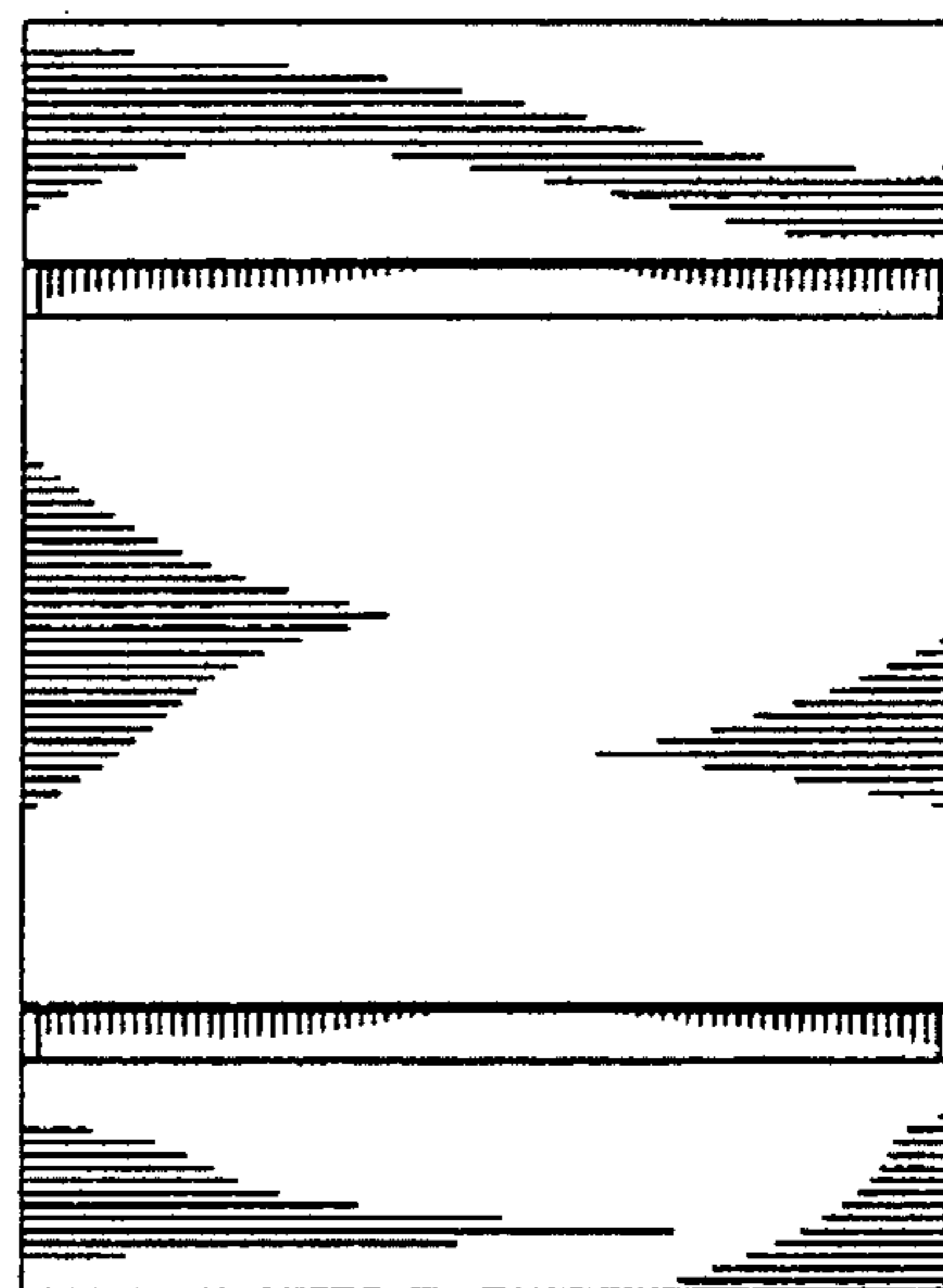

FIG. 22

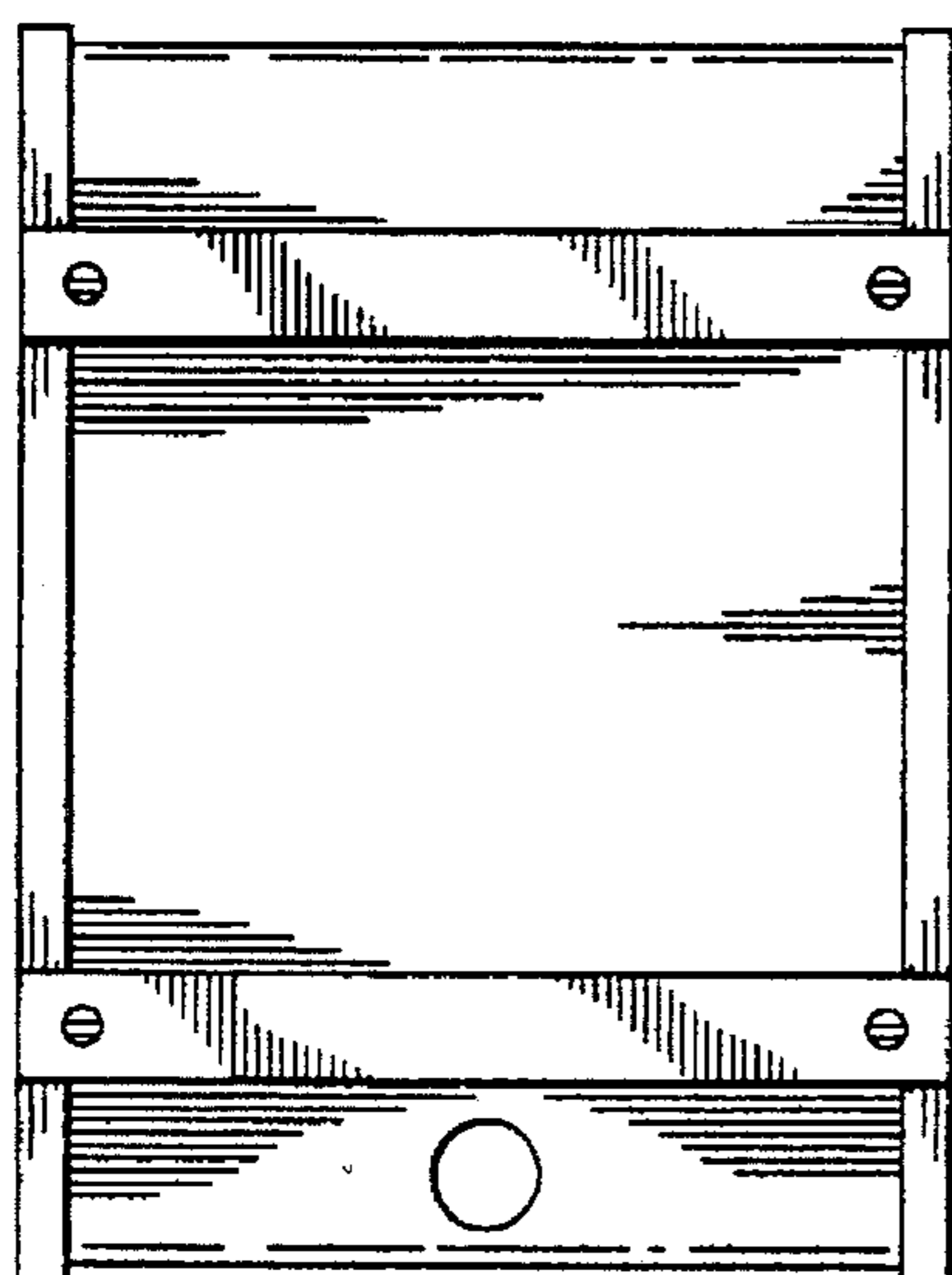

FIG. 23

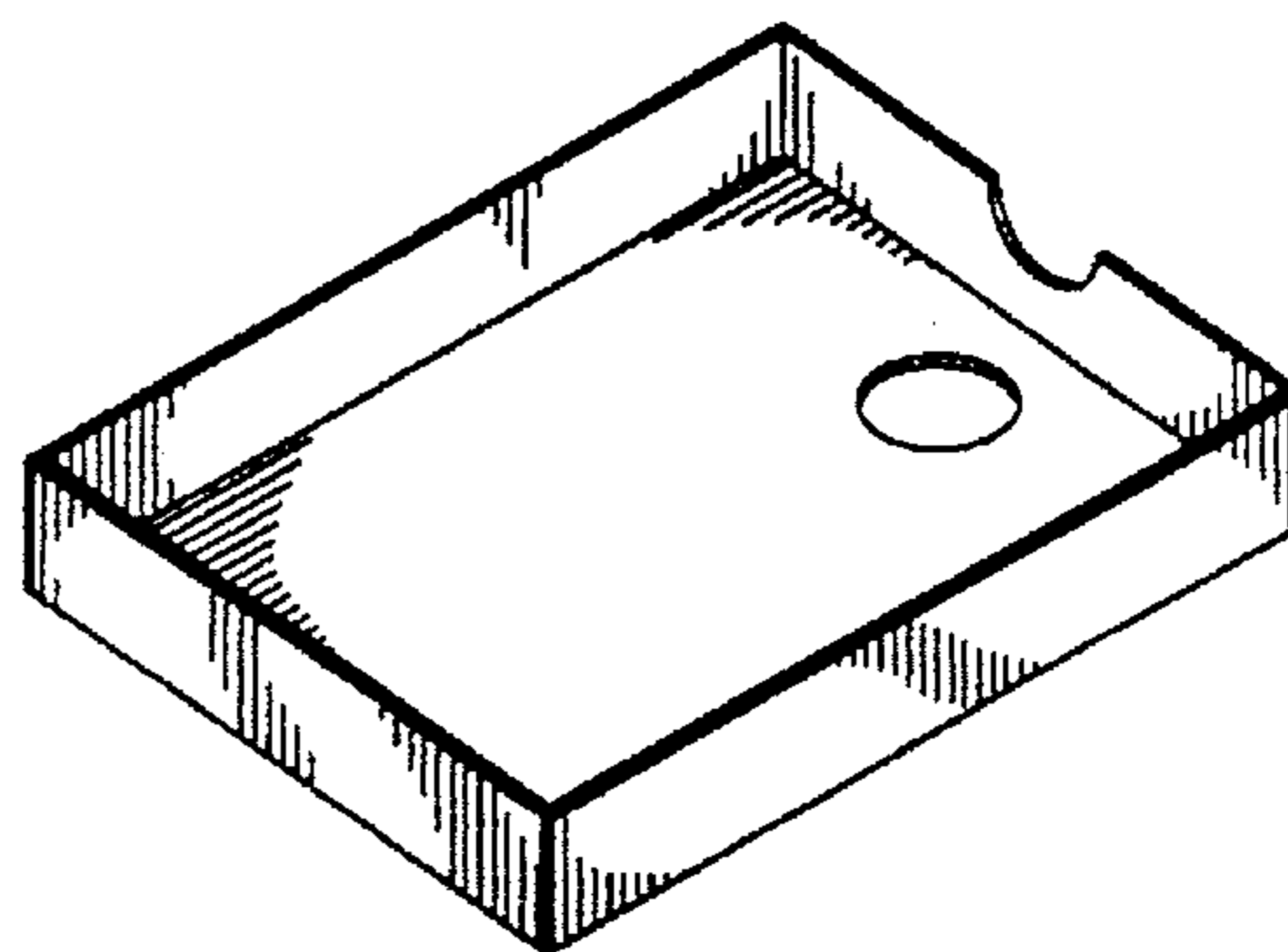

FIG. 24

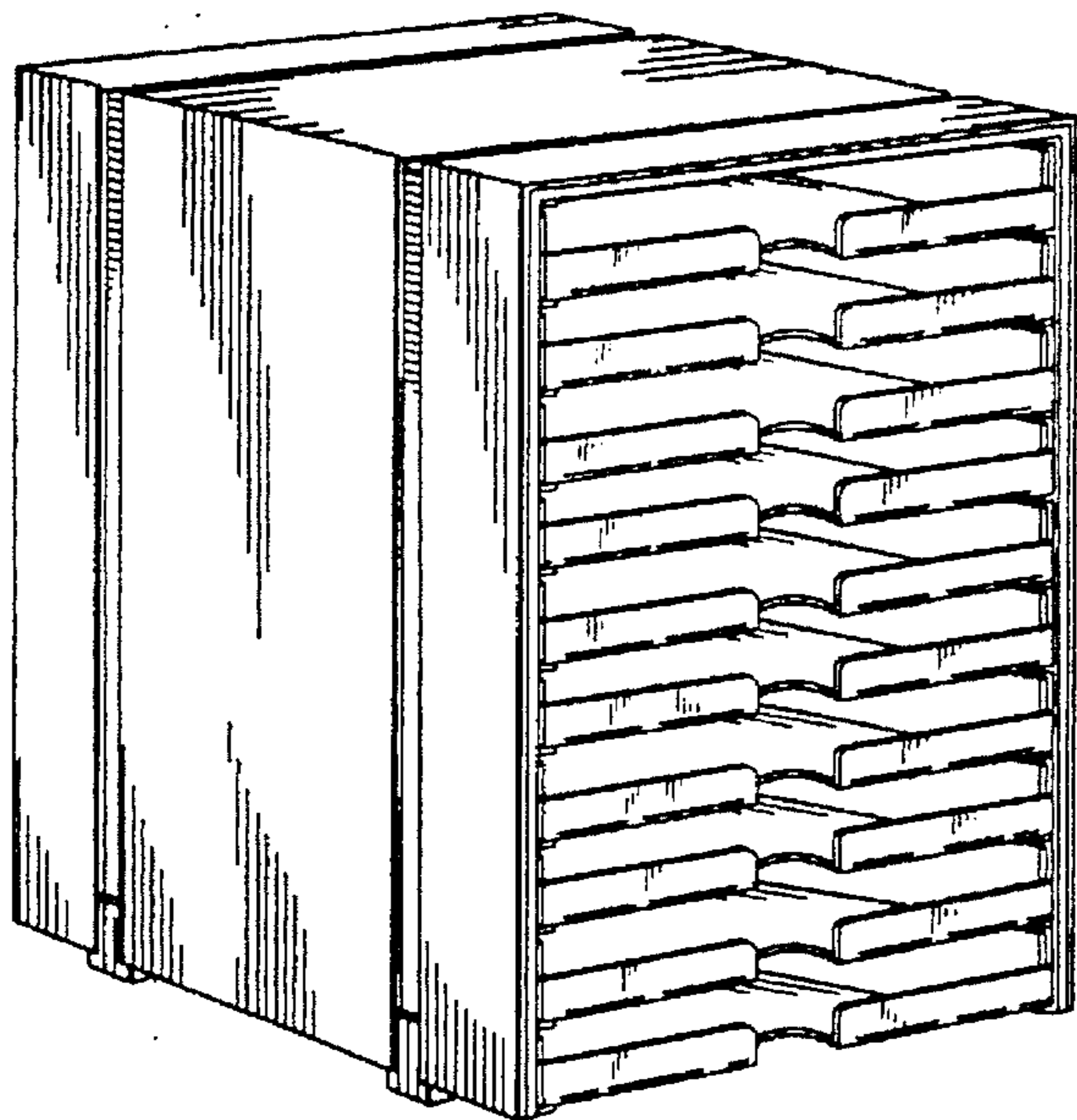

FIG. 25

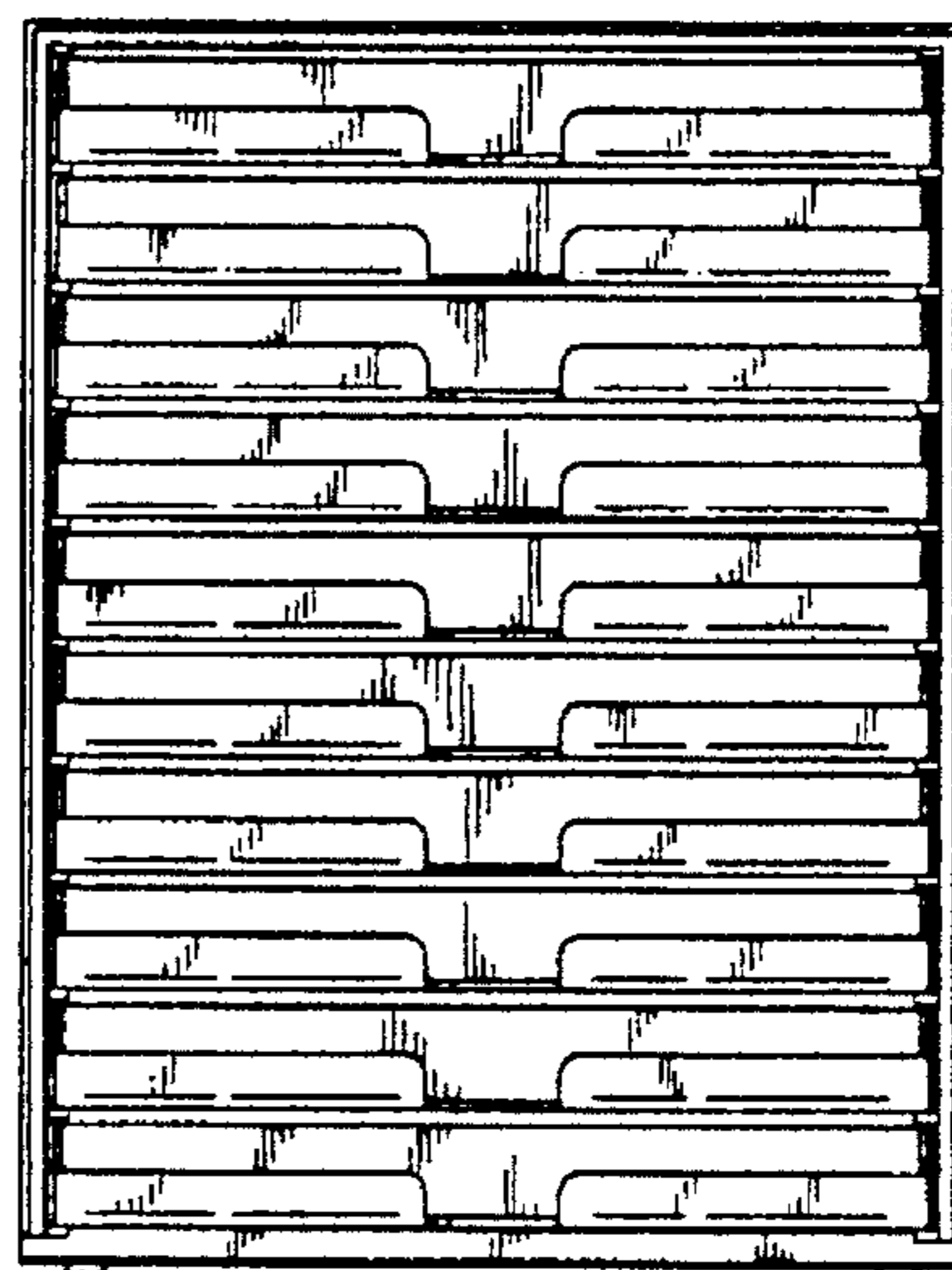

FIG. 26

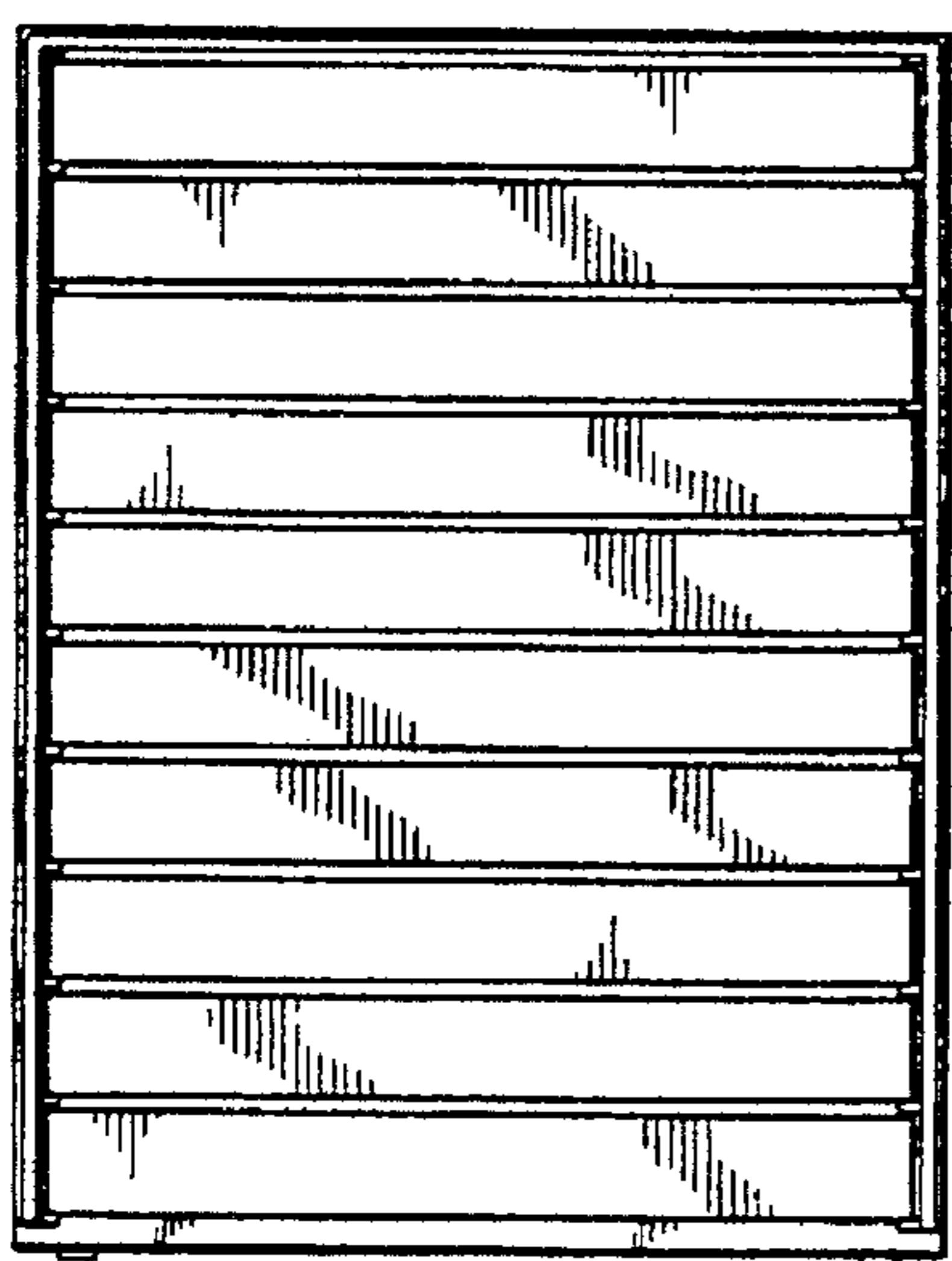

FIG. 27

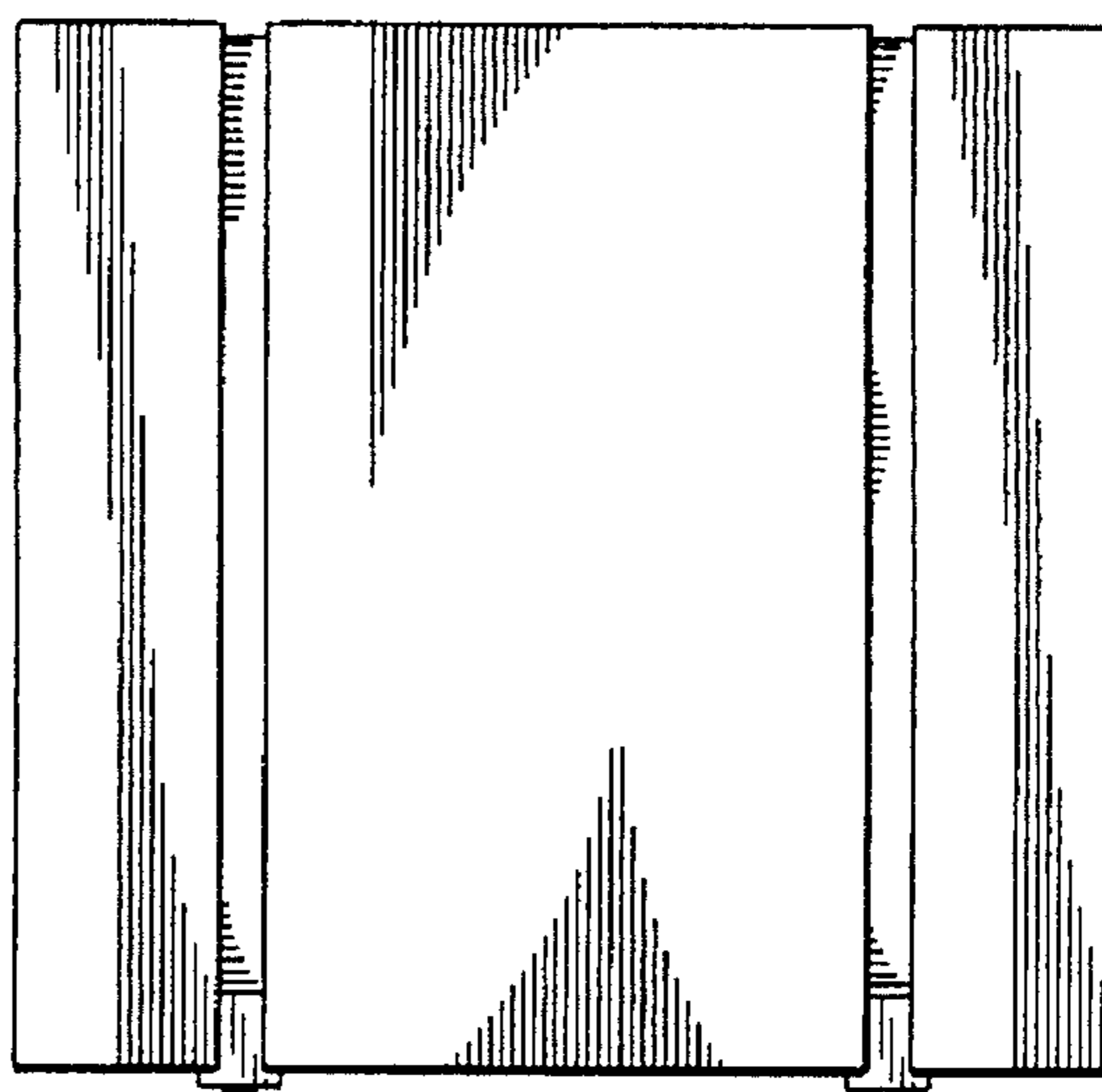

FIG. 28

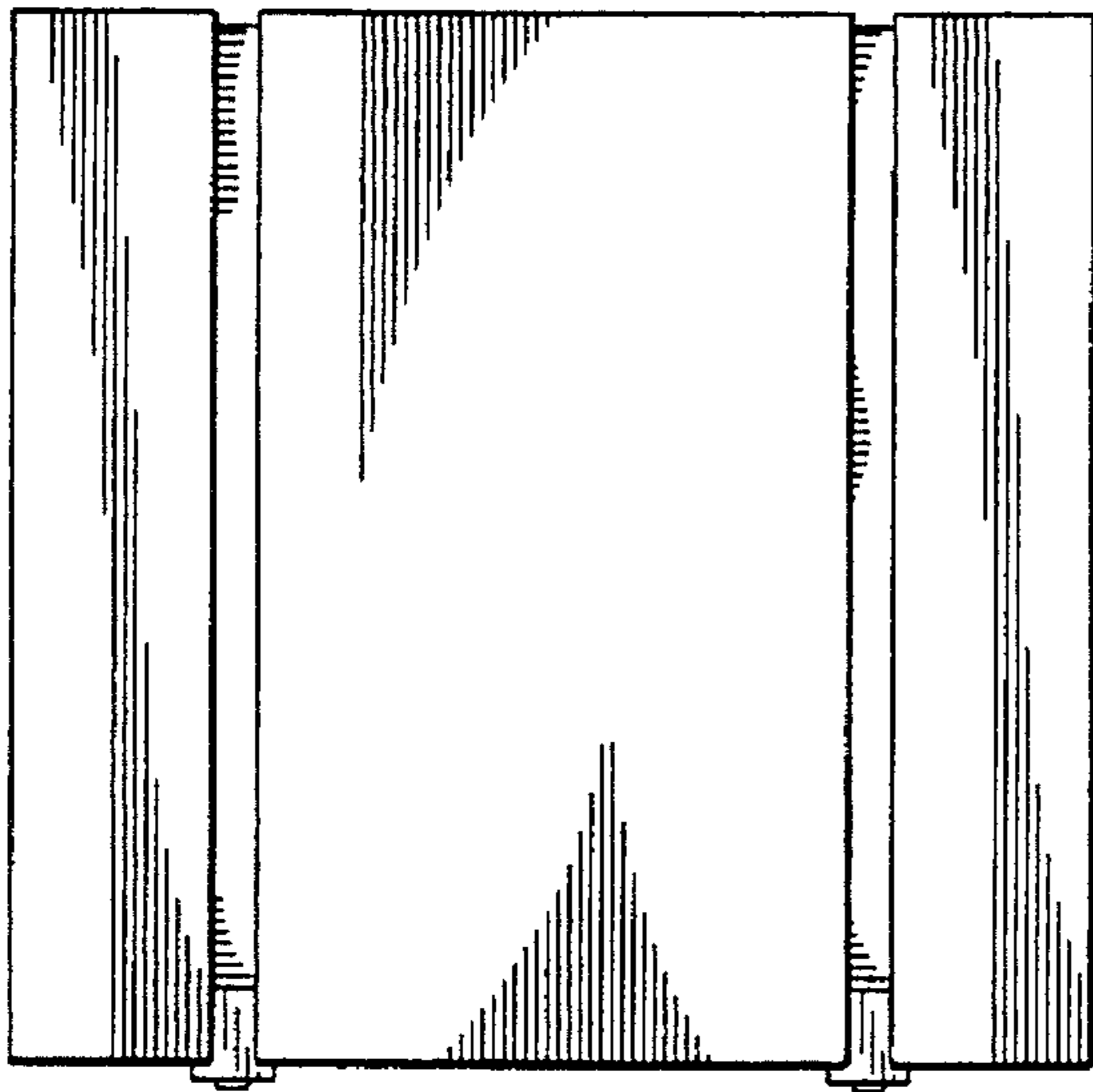

FIG. 29

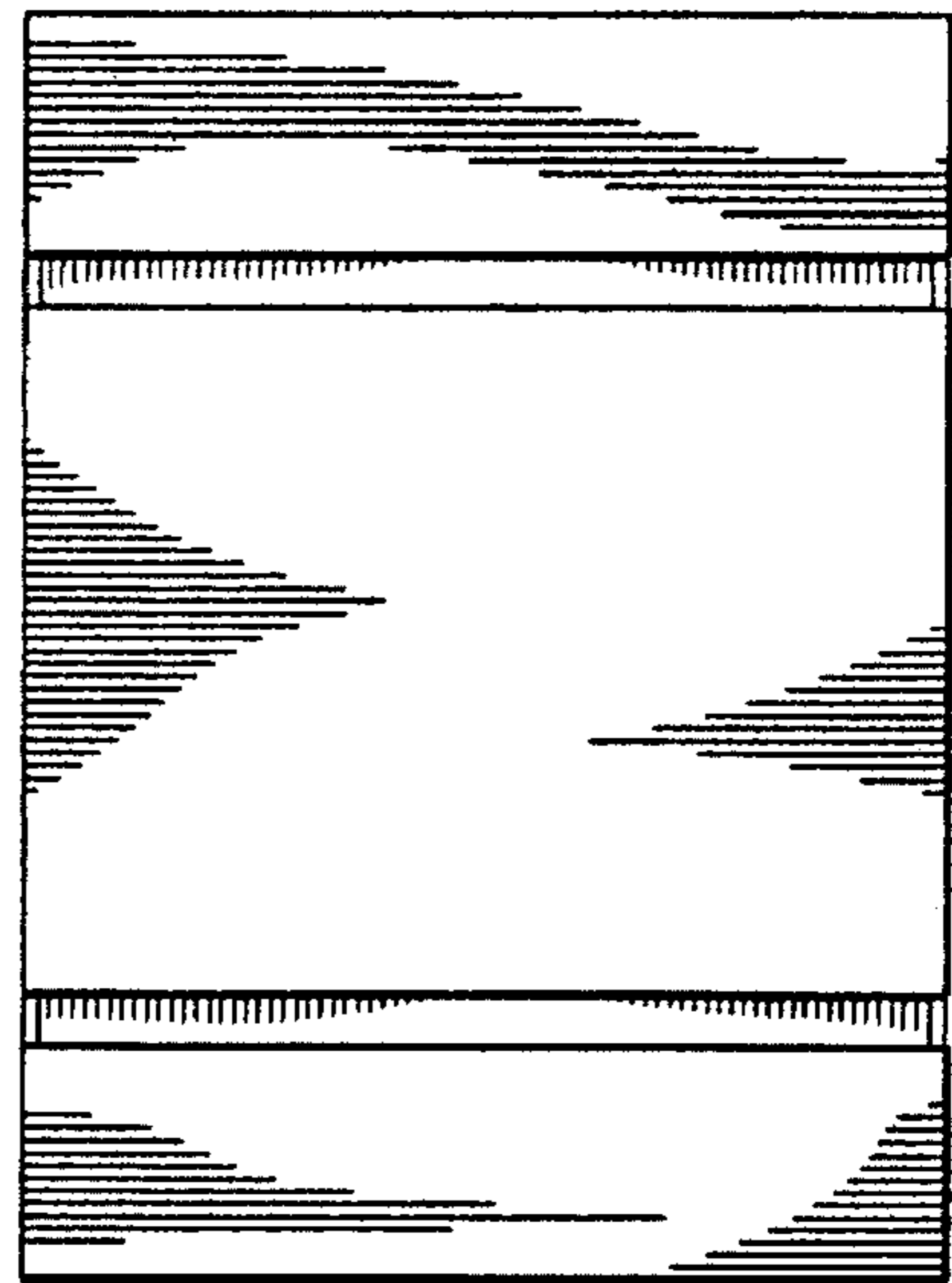

FIG. 30

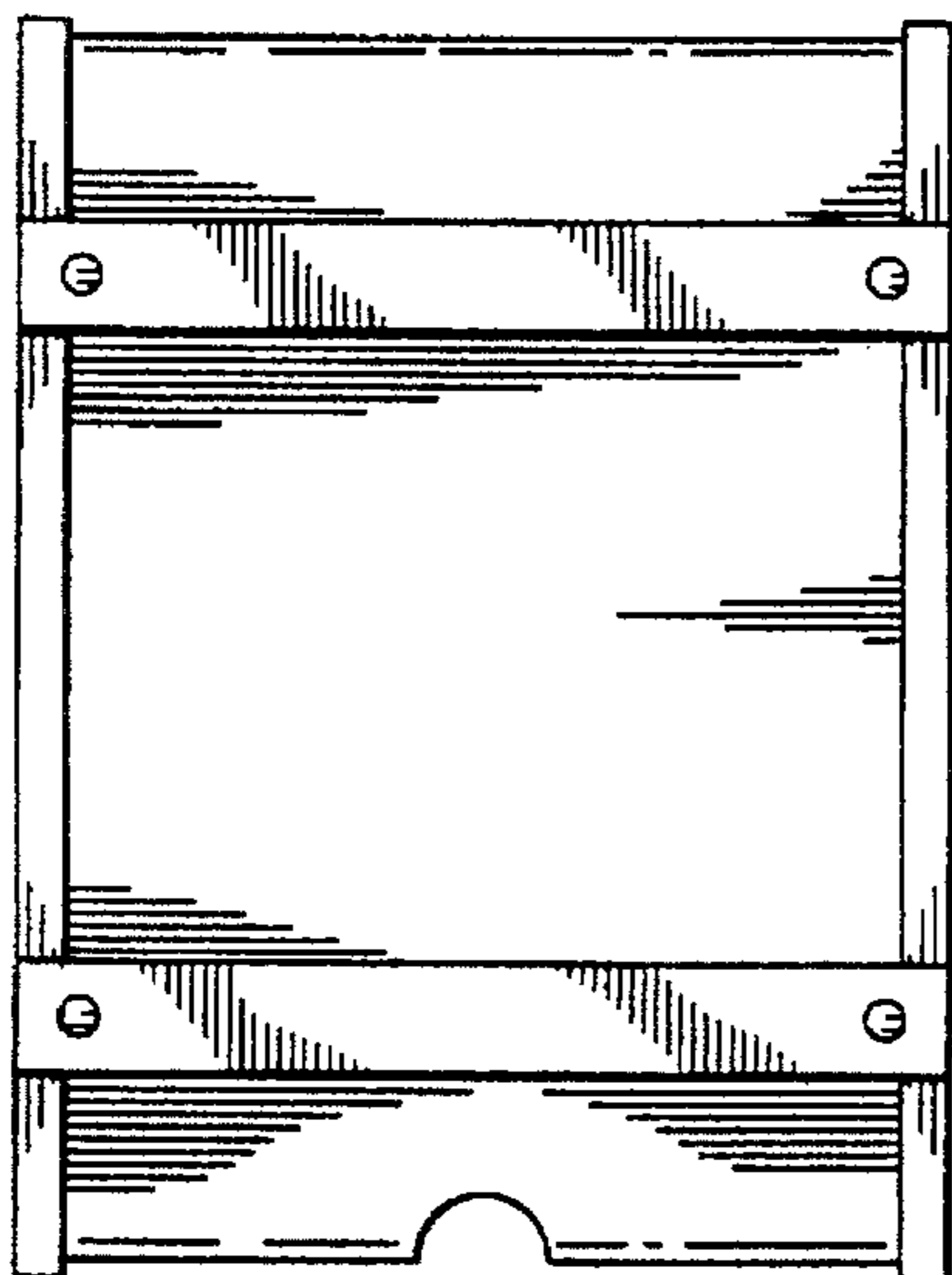

FIG. 31

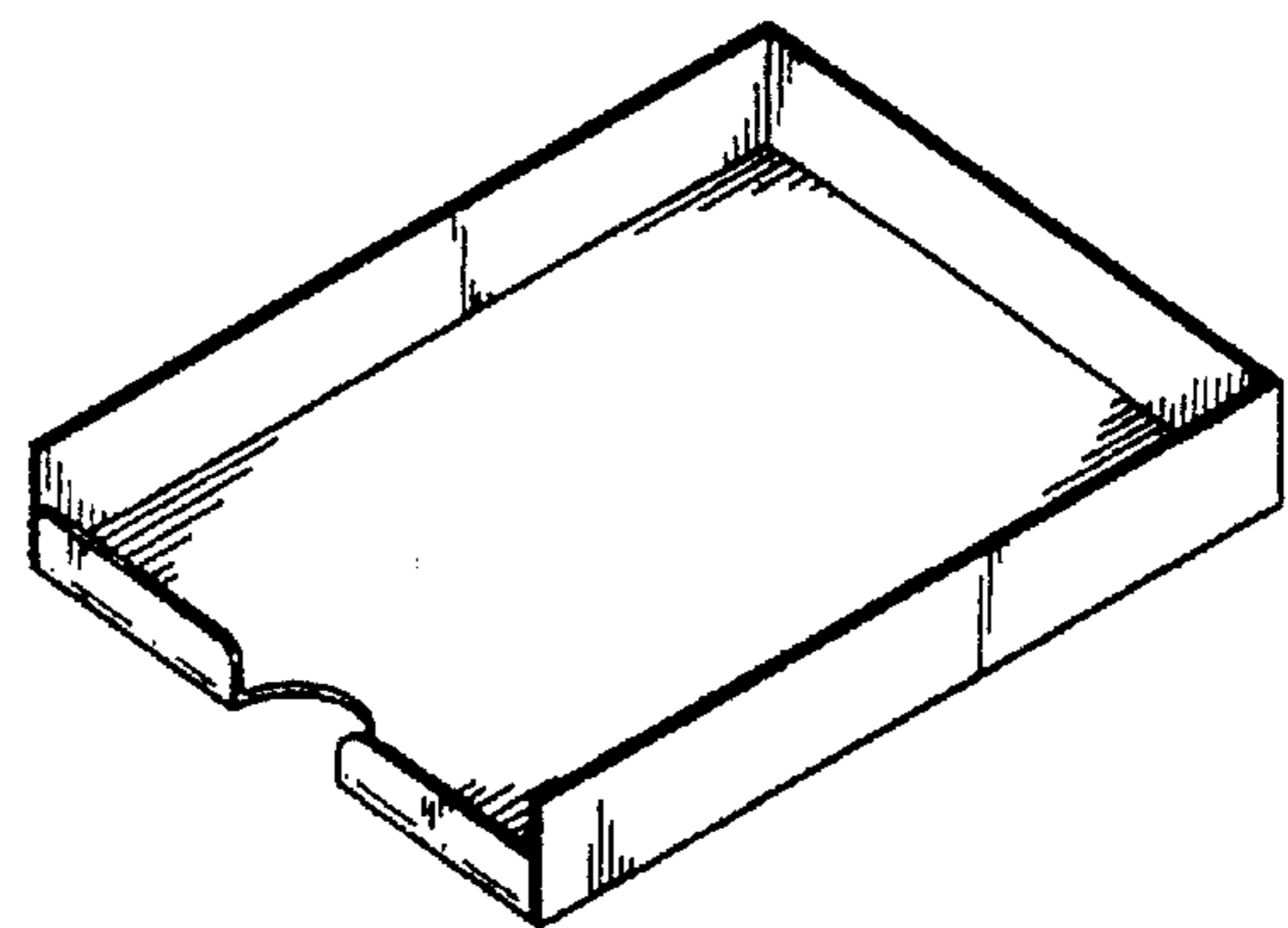

FIG. 32